

Patent Case Management Judicial Guide

Third Edition

Peter S. Menell
*Koret Professor of Law
Berkeley Center for Law & Technology
University of California, Berkeley School of Law*

Lynn H. Pasahow
Fenwick & West LLP

James Pooley
*Orrick, Herrington &
Sutcliffe LLP*

Matthew D. Powers
Tensegrity Law Group LLP

Steven C. Carlson
*Kasowitz, Benson, Torres
& Friedman LLP*

Jeffrey G. Homrig
Latham & Watkins LLP

George F. Pappas
Covington & Burling LLP

Carolyn Chang
Fenwick & West LLP

Colette Reiner Mayer
Morrison & Foerster LLP

Marc David Peters
Morrison & Foerster LLP

in collaboration with

Anita Choi
Morrison & Foerster LLP

John Fargo
*U.S. Department of
Justice*

Michael Sawyer
Covington & Burling LLP

Allison A. Schmitt
*University of California,
Berkeley*

Michael R. Ward
Morrison & Foerster LLP

Patricia Young
Latham & Watkins LLP

Federal Judicial Center 2016

This Federal Judicial Center publication was undertaken in furtherance of the Center's statutory mission to develop educational materials for the judicial branch. While the Center regards the content as responsible and valuable, it does not reflect policy or recommendations of the Board of the Federal Judicial Center.

© 2016 Peter S. Menell, Lynn H. Pasahow, James Pooley, Matthew D. Powers, Steven C. Carlson, Jeffrey G. Homrig, George F. Pappas, Carolyn Chang, Colette Reiner Mayer, Marc David Peters

email: pmenell@law.berkeley.edu

A print version of *Patent Case Management Judicial Guide* (3d ed. 2016), including all appendices, is available through Clause 8 Publishing (Clause8Publishing.com). The treatise is also available through the Lexis online database.

Summary Table of Contents

Table of Contents

Foreword

Preface

Acknowledgments

Chapter 1	Overview of the Patent System and General Principles for Effective Patent Case Management
Chapter 2	Early Case Management
Chapter 3	Preliminary Injunction
Chapter 4	Discovery
Chapter 5	Claim Construction
Chapter 6	Summary Judgment
Chapter 7	Pretrial Case Management
Chapter 8	Trial
Chapter 9	Posttrial
Chapter 10	ANDA and Biologics Cases: Patent Infringement Actions Involving FDA-Approved Drugs
Chapter 11	Design Patents
Chapter 12	Plant Patents
Chapter 13	Patent Suits Against the United States
Chapter 14	Patent Law Primer
Appendix A	Glossary
Appendix B	Acronyms
Appendix C	Patent Resources
Appendix D	Patent Local Rules
Appendix E	Model Patent Jury Instructions
Table of Cases	
Author Biographies	

Table of Contents

<i>Foreword to the Third Edition</i>	xxvii
<i>Foreword to the First Edition</i>	xxviii
<i>Preface to the Third Edition</i>	xxix
<i>Preface to the Second Edition</i>	xxx
<i>Preface to the First Edition</i>	xxxi
<i>Acknowledgments</i>	xxxiii
<i>Advisory Boards</i>	xxxiv

Chapter 1 Overview of the Patent System and General Principles for Effective Patent Case Management

1.1 Overview of the Patent System	1-2
1.1.1 Origins and Purposes	1-2
1.1.2 Evolution of the Patent System	1-5
1.1.2.1 Patent Act of 1952	1-8
1.1.2.2 America Invents Act of 2011	1-9
1.1.2.3 Deciphering and Interpreting Patent Law	1-11
1.1.3 Patent Institutions	1-12
1.1.3.1 The Patent Office	1-12
1.1.3.2 The Court of Appeals for the Federal Circuit	1-13
1.1.3.3 The International Trade Commission	1-14
1.1.3.4 The Marketplace for Patents and Patent Litigation	1-14
1.2 A Preliminary Note About Settlement of Patent Cases	1-15

Chapter 2 Early Case Management

2.1 Patent Litigation Timelines and Specialized Local Rules	2-4
2.1.1 Case Assignment—Patent Pilot Program	2-4
2.1.2 Protective Orders	2-5
2.1.2.1 Default Protective Orders	2-6
2.1.2.1.1 Timing	2-7
2.1.2.1.2 Substance—Tier Structure	2-7
2.1.2.1.3 Prosecution Bars	2-9
2.1.3 Managing Claim Winnowing and Construction of Claim Terms	2-9
2.1.3.1 Patent and Claim Winnowing 12	2-11
2.1.3.2 Claim Construction	2-13
2.1.3.2.1 Winnowing Claim Terms	2-18
2.1.3.2.2 Claim-Construction Briefing and Oral Argument	2-18
2.1.3.2.3 Claim Construction and Discovery	2-21
2.1.3.2.3.1 Discovery Prior to Claim Construction	2-21
2.1.3.2.3.2 Fact Discovery After Claim Construction	2-22
2.1.3.2.3.3 Expert Discovery After Claim Construction	2-22
2.1.3.2.3.4 Legal Contentions After Claim Construction	2-23

2.1.3.2.4	Claim Construction Generally Should Precede, but May Be Combined with, Summary Judgment	2-23
2.1.3.2.5	Claim Construction May Encourage Settlement	2-24
2.1.3.2.6	Preliminary Injunction Motions Usually Require Preliminary Claim Construction	2-25
2.1.4	Managing the Parties' Claims, Defenses, Prior Art References, and Counterclaims	2-26
2.1.4.1	Early Document Production	2-26
2.1.4.2	Ownership and Standing	2-26
2.1.4.3	Joint Infringement	2-26
2.1.4.4	Winnowing Prior Art References	2-27
2.1.4.5	Other Practices	2-27
2.2	Complaint and Answer	2-28
2.2.1	Plaintiff Standing Requirements	2-29
2.2.1.1	Infringement Plaintiff	2-29
2.2.1.1.1	Infringement Plaintiff Must Hold All Substantial Patent Rights	2-29
2.2.1.1.2	Plaintiff Must Join All Joint Patent Owners	2-29
2.2.1.1.3	An Exclusive Licensee Must Sometimes Join Its Licensor	2-30
2.2.1.1.4	A Nonexclusive Licensee Has No Standing to Sue	2-31
2.2.1.1.5	Patentee Can Only Convey Right to Sue by Transferring Substantially All Patent Rights	2-31
2.2.1.1.6	A Covenant Not to Sue or Similarly Binding Representations Can Moot a Controversy Between the Parties	2-32
2.2.1.1.7	Dismissal Based on Meritorious Standing Motions	2-32
2.2.1.2	Declaratory Judgment Plaintiff	2-32
2.2.1.2.1	Defendant's Declaratory Judgment Counterclaims Are Not Mooted by Dismissal of Plaintiff's Infringement Claims	2-34
2.2.1.2.2	Assignor Is Estopped from Seeking Declaratory Judgment of Invalidity	2-35
2.2.1.2.2.1	Parties in Privity with Assignor Are Also Estopped	2-35
2.2.1.2.3	Actual Case or Controversy Can Exist for Licensee in Good Standing Even in Absence of Material Breach	2-36
2.2.2	Defendant Standing Requirements	2-36
2.2.2.1	Infringement Defendants	2-36
2.2.2.1.1	Joinder Issues	2-37
2.2.2.2	Declaratory Judgment Defendants	2-39
2.2.3	Pleading	2-39
2.2.3.1	Infringement	2-39
2.2.3.2	Willful Infringement	2-42
2.2.3.2.1	Opinions of Counsel	2-42
2.2.3.2.2	Privilege Issues Relating to Opinions of Counsel	2-43
2.2.3.3	Defenses	2-44
2.2.3.3.1	Invalidity Defenses	2-44
2.2.3.3.2	Unenforceability Defenses	2-44
2.2.3.3.2.1	Inequitable Conduct Pled with Particularity	2-44
2.2.3.3.2.2	Privilege Issues Relating to Unenforceability	2-45

2.2.4	Counterclaims	2-45
2.2.4.1	Compulsory Counterclaims	2-46
2.2.4.2	Noncompulsory Counterclaims	2-46
2.2.5	Potential Overlap with Nonpatent Claims; Choice of Law	2-46
2.2.6	Interaction with Other Types of Actions	2-47
2.2.6.1	Bankruptcy	2-47
2.2.6.2	International Trade Commission Actions	2-47
2.2.6.2.1	Stays Relating to Parallel ITC Proceedings	2-48
2.2.6.2.2	Effect of ITC Rulings on District Court Proceedings	2-50
2.2.6.3	Parallel District Court Proceedings	2-51
2.2.6.4	PTO Review Proceedings—Reexamination, Reissue, and AIA Review	2-54
2.2.6.4.1	Stays Pending Review or Reexamination	2-55
2.2.6.4.2	Evaluating Stay Requests with Pending AIA Review	2-56
2.2.6.4.3	Special Case: Stay Request with Pending CBMR	2-57
2.2.6.5	Preemption of State-Law Unfair Competition Claims	2-58
2.2.7	Rule 11: Presuit Investigations—Objective Good Faith Basis for Filing Pleading	2-58
2.3	Jurisdiction and Venue	2-59
2.3.1	Personal Jurisdiction	2-59
2.3.2	Subject-Matter Jurisdiction	2-60
2.3.2.1	Original Jurisdiction	2-60
2.3.2.2	Supplemental Jurisdiction	2-60
2.3.3	Venue	2-61
2.3.3.1	Venue Transfer Motions	2-61
2.3.4	Multidistrict Coordination	2-65
2.4	Scheduling	2-66
2.5	Case-Management Conference	2-66
2.6	Salient Early Case-Management Issues	2-71
2.6.1	Multidefendant Litigations	2-71
2.6.1.1	Multidefendant Litigations Based on Standards Compliance	2-72
2.6.1.2	Customer/Manufacturer Multidefendant Litigations	2-72
2.6.2	Spoliation	2-74
2.6.3	Early Claim Construction	2-74
2.6.4	Patentable Subject Matter	2-76
2.6.5	Early Motions to Dismiss Indirect Infringement and Willfulness Claims	2-76
2.6.6	Damages Theories and Proof	2-77
2.6.7	Nuisance-Value Litigation	2-82
2.6.8	“Proportional” Scope of Discovery	2-83
2.7	Settlement and Mediation	2-83
2.7.1	Initiation of the Mediation Process	2-84
2.7.2	Selection of the Mediator	2-84
2.7.3	Scheduling the Mediation	2-85
2.7.4	Powers of the Mediator and Who Should Be Present During Mediation	2-86
2.7.5	Confidentiality of the Mediation	2-86
2.7.6	Relationship of the Mediation to the Litigation Schedule	2-87

2.7.7	Mediating Multiparty and Multijurisdictional Cases	2-88
2.7.8	Factors Affecting the Likelihood of Settlement of Particular Categories of Cases	2-88
Appendix 2.1	Initial Case-Management Conference Summary Checklist	2-93
Appendix 2.2a	Case-Management Checklist (Chief Judge Leonard Stark, District of Delaware)	2-97
Appendix 2.2b	Revised Procedures for Managing Patent Cases (Chief Judge Leonard Stark, District of Delaware) (June 18, 2014)	2-100
Appendix 2.2c	Revised Patent Form Scheduling Order (Chief Judge Leonard Stark, District of Delaware) (June 2014)	2-110
Appendix 2.3	Patent Pilot Program	2-119
Appendix 2.4	Protective Orders	2-123
Appendix 2.4a	Northern District of California, Patent Local Rule 2-2 Interim Model Protective Order	2-125
Appendix 2.4b	Northern District of California, Stipulated Protective Order for Litigation Involving Patents, Highly Sensitive Confidential Information, and/or Trade Secrets	2-142
Appendix 2.4c	Model Protective Order from the Northern District of Illinois	2-160
Appendix 2.4d	Stipulation for Protective Order from the District of Minnesota	2-165
Appendix 2.4e	Default Standard for Access to Source Code from the District of Delaware	2-170
Appendix 2.5a	Mediation Evaluation Form for Attorneys, Northern District of Illinois	2-171
Appendix 2.5b	Mediation Evaluation Form for Mediators, Northern District of Illinois	2-173
Appendix 2.5c	Mediation Evaluation Form for Parties, Northern District of Illinois ...	2-175
 Chapter 3 Preliminary Injunction		
3.1	Introduction	3-2
3.1.1	The Special Circumstances of the Preliminary Injunction Application in Patent Cases	3-4
3.1.2	Opportunities Presented by Preliminary Injunction Applications in Patent Cases	3-4
3.1.3	Frequency of Preliminary Injunction Applications in Patent Cases	3-5
3.1.4	Governing Legal Standards: § 283, Federal Circuit Law, and Federal Rule of Civil Procedure 65	3-7
3.1.5	Tension Between Right to Exclude and Equitable Considerations	3-8
3.1.6	Meaning of Status Quo	3-8
3.2	Standards and Burdens	3-9
3.2.1	Discretion of Trial Court	3-9
3.2.2	Factors to Be Considered	3-9
3.2.2.1	Reasonable Likelihood of Success on the Merits	3-10
3.2.2.1.1	Claim Construction and Infringement	3-10
3.2.2.1.2	Invalidity	3-10
3.2.2.2	Irreparable Harm if the Preliminary Injunction Is Not Granted	3-11
3.2.2.2.1	Presumption	3-11

3.2.2.2.2	Evidentiary Factors	3-11
3.2.2.2.3	Nonpracticing Entities	3-13
3.2.2.2.4	Nexus Requirement	3-14
3.2.2.3	Balance of Hardships	3-14
3.2.2.4	Impact on the Public Interest	3-15
3.2.2.5	Burdens of Proof and Persuasion	3-16
3.2.2.6	Effect of PTAB Review Proceedings	3-17
3.2.2.6.1	Grant of Ex Parte Reexamination	3-17
3.2.2.6.2	Institution of Inter Partes Review, Covered Business-Method Review, or Postgrant Review	3-18
3.2.2.6.3	PTAB Cancellation of Rejection of Claims	3-18
3.3	Temporary/Ex Parte Orders	3-19
3.3.1	Generally	3-19
3.3.2	Procedure	3-20
3.4	Discovery	3-21
3.5	Hearing	3-23
3.5.1	Whether to Conduct a Hearing	3-23
3.5.2	Notice and Scheduling	3-23
3.5.3	Evidentiary Showing—What to Expect	3-24
3.6	Rule 65 Trial	3-24
3.7	Bond	3-25
3.8	Order	3-26
3.8.1	Specificity	3-26
3.8.2	Parties Affected	3-28
3.8.3	Modification	3-28
3.9	Appellate Review	3-29
3.9.1	Writ Review	3-29
3.9.2	Stays	3-30
3.10	Enforcement	3-31
Appendix 3.1	Template for Order Granting a Preliminary Injunction	3-33

Chapter 4 Discovery

4.1	Controlling Law and Standard of Review	4-2
4.2	Scope of Patent Discovery	4-2
4.2.1	Proportionality	4-2
4.2.2	Initial Disclosures	4-3
4.2.3	Requests for Production of Documents	4-5
4.2.3.1	Nonparty Subpoena Requests	4-6
4.2.4	Interrogatories	4-7
4.2.5	Depositions	4-8
4.2.6	Protective Orders—Handling of Confidential Documents	4-9
4.2.6.1	Overdesignation of Confidential Documents	4-9
4.2.6.2	Claw-Back Provisions for Privileged Documents	4-10
4.2.6.3	Prosecution Bars	4-11
4.2.6.3.1	Prosecution Bars and PTAB Review	4-12

4.2.7 Foreign Discovery Issues	4-13
4.3 Claim Construction and Discovery	4-15
4.4 Electronic Discovery	4-15
4.4.1 Overview of Electronic Discovery	4-15
4.4.2 Electronic Discovery in Patent Cases	4-17
4.4.2.1 Spoliation in Patent Cases	4-20
4.4.3 Issues with Specific File Types in Electronic Discovery	4-21
4.5 Management of Discovery Disputes	4-23
4.6 Common Discovery Motions	4-24
4.6.1 Discovery Regarding Patentee’s Prefiling Investigation	4-24
4.6.2 Production of Information About Products	4-25
4.6.3 Contentions About Infringement, Invalidity, and Unenforceability	4-26
4.6.4 Bifurcation or Stay of Discovery Pending Reexamination of Patent	4-27
4.6.5 Bifurcation or Stay of Discovery Pending Early Dispositive Motion	4-27
4.6.6 Bifurcation or Stay of Discovery on Issues Bifurcated for Trial	4-28
4.6.7 Privilege Waiver Based on Defendant’s Election to Rely on Advice of Counsel	4-28
4.6.8 Discovery from Patent Prosecution Counsel	4-29
4.6.9 Access to Confidential Information by Patent Prosecution Counsel	4-30
4.6.10 License Agreements and Other Third-Party Confidential Information	4-31
4.6.10.1 Discovery Regarding Prior License and Settlement Negotiations	4-32
Appendix 4.1 Table, Circuit Court’s Approach to Sanctions for Spoliation	4-35
Appendix 4.2 Federal Circuit Model Order Regarding e-Discovery in Patent Cases	4-49
Appendix 4.3 Model Orders for e-Discovery	4-55

Chapter 5 Claim Construction

5.1 Timing and Procedure	5-5
5.1.1 Timing of <i>Markman</i> Hearings	5-5
5.1.2 Pre- <i>Markman</i> Procedures	5-6
5.1.2.1 Mandatory Disclosure of Positions	5-6
5.1.2.1.1 Early Disclosure of Infringement and Invalidity Contentions	5-7
5.1.2.1.2 Disclosure of Claims to Construe and Proposed Constructions	5-7
5.1.2.1.3 Mechanisms for Limiting the Number of Claim Terms to Construe ..	5-8
5.1.2.1.3.1 Severance Versus Postponement	5-10
5.1.2.1.4 Recommended Approach: Mandatory Disclosure of Impact of Proposed Constructions	5-12
5.1.2.1.5 Recommended Approach: Mandatory Disclosure of Terms Requiring Fact-Finding	5-14
5.1.2.2 Educating the Court About Underlying Science and Technology	5-15
5.1.2.2.1 Technology Tutorials	5-16
5.1.2.2.1.1 Anticipating the Need for an Appellate Record	5-18
5.1.2.2.2 Court-Appointed Experts	5-18
5.1.2.2.2.1 Technical Advisor	5-18
5.1.2.2.2.2 Special Master	5-20
5.1.2.2.2.3 Expert Witness	5-20

5.1.3	Conduct of the <i>Markman</i> Hearing	5-21
5.1.3.1	The “Evidentiary” Nature of <i>Markman</i> Hearings	5-21
5.1.3.2	Application of the Federal Rules of Evidence	5-22
5.1.3.3	Safeguards on Extrinsic Evidence	5-22
5.1.3.4	Evidence of the Accused Device	5-23
5.1.3.5	Evidence of the Prior Art	5-23
5.1.3.6	The Need to Focus <i>Markman</i> Proceedings on Claim Interpretation	5-24
5.1.3.7	Sequence of Argument	5-25
5.1.3.8	Claim Construction in Multidefendant Disputes	5-25
5.1.4	The <i>Markman</i> Ruling	5-28
5.1.4.1	Interrelationship to Jury Instructions	5-28
5.1.4.2	Basis for Appellate Review	5-29
5.1.4.3	Not All Terms Require “Construction”	5-29
5.1.4.4	The Court May Adopt Its Own Construction	5-30
5.1.4.5	Tentative Rulings Prior to the <i>Markman</i> Hearing	5-30
5.1.5	Amendments to Infringement and Invalidity Contentions	5-31
5.1.6	Interlocutory Appeal of <i>Markman</i> Rulings	5-31
5.1.7	Application of the <i>Markman</i> Ruling to Trial	5-32
5.2	Analytic Framework and Substantive Principles	5-33
5.2.1	Claim Drafting: The Genesis and Evolution of Claim Terms	5-34
5.2.2	Sources for Deriving Claim Meaning	5-36
5.2.2.1	Principal Source: Intrinsic Evidence	5-37
5.2.2.1.1	Prosecution History	5-37
5.2.2.1.2	Related and Foreign Applications	5-38
5.2.2.2	Extrinsic Evidence Is Permissible, but It May Not Contradict or Override Intrinsic Evidence	5-39
5.2.2.2.1	Illustrations of Reliance (and Nonreliance) upon Extrinsic Evidence	5-40
5.2.2.2.2	Conclusory Expert Opinions Should Be Disregarded	5-43
5.2.3	Claim Construction: Two Stages of Analysis	5-43
5.2.3.1	Step 1: Is Construction of a Claim Required?	5-43
5.2.3.1.1	Is There a Genuine Dispute About the Claim Term?	5-44
5.2.3.1.2	Would Claim Construction Help the Jury?	5-45
5.2.3.1.3	Is Claim Construction a Priority?	5-45
5.2.3.1.4	Have the Claims Been Construed Before?	5-45
5.2.3.1.5	Is the Term Amenable to Construction?	5-46
5.2.3.1.5.1	Lay Terms	5-47
5.2.3.1.5.2	Terms of Degree	5-48
5.2.3.1.5.2.1	Terms of Degree: Potential Indefiniteness	5-48
5.2.3.1.5.2.2	The Court Should Not Delineate Terms of Degree “Where the Patent Provides No Standard”	5-50
5.2.3.1.5.2.3	The Appropriate Standard for Defining or Declining to Define Terms of Degree	5-51
5.2.3.1.5.3	Technical Terms	5-52
5.2.3.2	Step 2: Interpretation of Claim Terms	5-52
5.2.3.2.1	Claim-Construction Framework	5-53

5.2.3.2.2	Starting Point for Analysis: “Ordinary Meaning”	5-56
5.2.3.2.2.1	“Presumption of Dictionary Definition” Obsolete	5-57
5.2.3.2.2.2	“Heavy Presumption” of Ordinary Meaning	5-57
5.2.3.2.3	Interpreting Claim Language in Light of the Specification	5-58
5.2.3.2.3.1	The Role of Preferred Embodiments in Claim Construction	5-59
5.2.3.2.3.1.1	Claim Scope Generally Includes Preferred Embodiments	5-60
5.2.3.2.3.1.2	Is the Patent Limited to the Preferred Embodiments?	5-60
5.2.3.2.3.1.3	Does the Number and/or Range of Embodiments Affect the Scope of the Claims?	5-62
5.2.3.2.3.1.4	Does Ambiguity in a Claim Term Limit Its Scope to Preferred Embodiment(s)?	5-63
5.2.3.2.3.1.5	Characterizations of “the Invention” or “the Present Invention”	5-64
5.2.3.2.3.2	Distinctions over the Prior Art	5-66
5.2.3.2.3.3	Consistent Usage of Claim Terms	5-67
5.2.3.2.3.4	Prosecution Disclaimers	5-68
5.2.3.2.4	Looking to Other Claims: The Doctrine of Claim Differentiation	5-69
5.2.3.2.4.1	Presumption of Claim Differentiation May Be Rebutted Based on Specification or Prosecution History Estoppel	5-70
5.2.3.2.4.2	Presumption of Claim Differentiation Does Not Apply to Means-Plus-Function Claims	5-71
5.2.3.2.5	Significance of the “Preamble” in Claim Construction	5-71
5.2.3.3	Claim Terms Having Conventional, Presumed, or Established Meanings	5-72
5.2.3.4	Interpreting Terms to Preserve Validity	5-78
5.2.3.5	Special Case: Means-Plus-Function Claims Limited to Structures in Specification and Equivalents Thereof as of Time of Issuance	5-78
5.2.3.5.1	Step 1: Is the Term in Question “Means-Plus-Function”?	5-79
5.2.3.5.2	Step 2: Interpretation of Means-Plus-Function Claim Terms	5-80
5.2.3.5.2.1	Step 2A: Identify Claim Term Function	5-80
5.2.3.5.2.2	Step 2B: Identify “Corresponding Structure, Material, or Acts”	5-81
5.2.3.5.2.3	Step 2C: “Equivalents Thereof”	5-81
5.2.3.5.2.4	Specific Rule for Means-Plus-Function Claims in the Computer Software Context	5-81
5.2.4	Product-by-Process Claims	5-82
5.2.5	Dysfunctional Claims: Mistakes and Indefiniteness	5-83
5.2.5.1	Mistakes	5-83
5.2.5.2	Indefiniteness	5-84
5.3	Deference to Prior Claim-Construction Rulings	5-88
5.3.1	Distinguishing Among Preclusion and Estoppel Doctrines	5-89
5.3.2	Issue Preclusion/Collateral Estoppel	5-91
5.3.2.1	Identity of Issues	5-91
5.3.2.2	Actual Litigation	5-92
5.3.2.3	Full and Fair Opportunity to Litigate	5-92
5.3.2.4	Determination Was Essential to the Final Judgment	5-93
5.3.2.4.1	Finality	5-93

5.3.2.4.2	Essential to the Final Judgment	5-95
5.3.2.5	Reasoned Deference as a Prudent Approach to Issue Preclusion	5-96
5.3.3	Judicial Estoppel	5-97
5.3.4	Stare Decisis	5-98
5.3.5	U.S. International Trade Commission Determinations	5-101
5.3.6	Patent and Trademark Office Determinations	5-101
5.3.7	Motions to Vacate Claim-Construction Rulings in Connection with Settlement	5-101
5.4	Practical Tips for Claim Construction	5-102
5.4.1	Recognizing and Avoiding the Pitfalls of Sound-Bite and “Cite”-Bite Advocacy	5-102
5.4.1.1	“Heavy Presumption of Ordinary Meaning”	5-103
5.4.1.2	“Presumption in Favor of Dictionary Definition” No Longer Applies	5-103
5.4.1.3	Reliance on Extrinsic Evidence Is Permissible but Cannot Override Intrinsic Evidence	5-104
5.4.2	Checklist/Discussion Points for Claim-Construction Hearing	5-104
5.4.2.1	Procedural Aspects	5-104
5.4.2.2	Substantive Aspects	5-105
Appendix 5.1	Joint Claim-Construction Statement Order	5-107
Appendix 5.2	Sample Joint Claim-Construction Charts	5-109

Chapter 6 Summary Judgment

6.1	Managing the Summary Judgment Process	6-2
6.1.1	Distinguishing Questions of Law from Questions of Fact	6-2
6.1.2	Summary Judgment and Claim Construction	6-9
6.1.3	Recommended Dual-Track Approach to Summary Judgment	6-10
6.1.3.1	“First-Track” Summary Judgment Motions	6-11
6.1.3.2	“Second-Track” Summary Judgment Motions	6-12
6.1.3.3	Implementing a Dual-Track Approach to Summary Judgment	6-13
6.1.3.4	Recognizing First-Track Summary Judgment Motions	6-14
6.1.3.4.1	Noninfringement and Divided Infringement	6-14
6.1.3.4.2	Invalidity Challenges Under § 112	6-15
6.1.3.4.3	Invalidity Challenges Under §§ 102 and 103	6-16
6.1.3.4.4	Invalidity Challenges Under § 101	6-17
6.1.4	Summary Judgment Independent from Claim Construction (Off-Track)	6-20
6.1.5	Streamlining the Summary Judgment Process	6-21
6.1.5.1	Recommended Approach: Letter Briefs Followed by Summary Judgment Motions	6-22
6.1.5.2	Limiting the Number of Summary Judgment Motions or the Number of Pages of Summary Judgment Briefing	6-22
6.1.5.3	Multiple Rounds of Summary Judgment Hearings	6-23
6.1.6	The Summary Judgment Hearing	6-24
6.1.6.1	Length and Division of Time	6-25
6.1.6.2	Live Testimony	6-25
6.1.6.3	Graphics	6-25
6.1.6.4	Technology Tutorial	6-25

6.1.7	Expert Declarations Filed in Connection with Summary Judgment Motions ...	6-26
6.1.7.1	Some Expert Testimony Cannot Defeat Summary Judgment	6-26
6.1.7.1.1	Testimony About Conclusions of Law	6-26
6.1.7.1.2	Conclusory Testimony	6-26
6.1.7.1.3	Testimony Contradicting Clear Disclosure of Prior Art	6-26
6.1.7.1.4	Testimony Contradicting Admissions of a Party	6-27
6.1.7.2	Legal Insufficiency of Expert Testimony	6-27
6.1.7.3	Expert Testimony Beyond the Scope of the Expert Report	6-27
6.1.8	Narrowing Trial Issues Through Federal Rule of Civil Procedure 56(g)	6-29
6.2	Substantive Issues Commonly Raised During Summary Judgment	6-29
6.2.1	Issues More Amenable to Summary Judgment	6-30
6.2.1.1	Validity	6-30
6.2.1.1.1	Patentable Subject Matter	6-30
6.2.1.1.2	Obviousness	6-32
6.2.1.1.3	Anticipation	6-35
6.2.1.1.4	Section 112(f) Indefiniteness	6-35
6.2.1.1.5	Section 112(b) Indefiniteness Under <i>Nautilus</i>	6-36
6.2.1.2	Infringement	6-38
6.2.1.2.1	Absence of Literal Infringement	6-38
6.2.1.2.2	Whether Infringement Under the Doctrine of Equivalents Is Barred by <i>Festo</i>	6-38
6.2.1.2.3	Whether Infringement Under the Doctrine of Equivalents Would Violate the <i>Wilson Sporting Goods</i> Doctrine	6-39
6.2.1.2.4	The Actions Accused of Infringement Did/Did Not Occur Within the United States	6-39
6.2.1.2.5	The Absence of Evidence of Direct Infringement Bars Claims of Indirect Infringement	6-40
6.2.1.2.6	“Divided” (Joint) Infringement: The Actions Accused of Infringement Are Made by Multiple Parties, Not Just the Accused Infringer	6-40
6.2.1.2.7	Absence of Evidence Showing the Required Mental State for Indirect Infringement	6-41
6.2.1.2.8	License and Exhaustion Defenses	6-42
6.2.1.3	Damages	6-42
6.2.2	Issues Less Amenable to Summary Judgment	6-45
Appendix 6.1	Sample Standing Order Setting a Schedule for First-Track Summary Judgment Motions	6-47

Chapter 7 Pretrial Case Management

7.1	Pretrial Conference	7-2
7.1.1	Timing	7-3
7.1.2	Participation	7-3
7.1.3	The Pretrial Order	7-3
7.1.4	Motions at the Pretrial Conference	7-3
7.2	Trial and Disclosure Schedule	7-4

7.3	Jury Instructions	7-5
7.3.1	Preliminary Instructions	7-5
7.3.2	Final Instructions—Timing	7-6
7.3.3	Final Instructions—Substance	7-6
7.3.4	Final Instructions—Common Disputes	7-7
7.3.4.1	Integration of Case-Specific Contentions	7-7
7.3.4.2	Claim-Construction Instruction	7-7
7.3.4.3	The “Presumption” of Validity Instruction	7-8
7.3.4.4	The Obviousness Instruction	7-9
7.3.4.4.1	Background: Pre-KSR Obviousness Law and Jury Instructions	7-10
7.3.4.4.2	Post-KSR Obviousness Law and Jury Instructions	7-11
7.3.4.5	Willfulness	7-14
7.3.4.6	Inducement of Infringement	7-16
7.3.4.7	Damages	7-17
7.3.4.7.1	Royalty Base	7-19
7.3.4.7.2	Royalty Rate	7-23
7.4	Substantive Limitations on Expert Testimony	7-23
7.4.1	The Role of Experts in Patent Cases	7-24
7.4.2	Timing and Procedure: When and How Should the Court Exercise Its Gatekeeping Role?	7-25
7.4.3	Specific Substantive Limitations on Expert Testimony	7-27
7.4.3.1	Improper Subject Matter	7-27
7.4.3.1.1	State of Mind of Another Person, Usually an Inventor, Prosecutor, or Examiner	7-27
7.4.3.1.2	Matters of Law	7-28
7.4.3.2	Inadequate Qualifications	7-29
7.4.3.3	Unreliable Analysis	7-29
7.4.3.3.1	Conclusory Expert Opinions	7-30
7.4.3.3.2	Unreliability of the Methodology or Its Application	7-32
7.4.3.3.2.1	Misapplication of the <i>Georgia-Pacific</i> Factors	7-32
7.4.3.3.2.1.1	Consideration of Factors Not Specified in <i>Georgia-Pacific</i>	7-33
7.4.3.3.2.1.2	Selective Use of the GP Factors	7-34
7.4.3.3.2.1.3	Use of an Incorrect Date for the Hypothetical Negotiation ..	7-34
7.4.3.3.2.1.4	Use of Facts that Post-Date the Hypothetical Negotiation	7-34
7.4.3.3.2.2	Use of an Incorrect Base for Damages	7-36
7.4.3.3.2.3	Reliance on a Legally Insufficient Methodology	7-36
7.4.3.3.2.4	Litigation Surveys	7-37
7.4.4	Motions Seeking to Prevent Lay Witness Opinions and Expert Witness Fact Testimony	7-39
7.5	Managing Patent Trials through Motions <i>In Limine</i>	7-39
7.5.1	Maintaining the Integrity of the Infringement/Validity Framework	7-40
7.5.1.1	Motion to Bar a Comparison Between the Accused Product and an Embodying Product (or Between Prior Art and an Embodying Product)	7-41
7.5.1.2	Motion to Bar Presentation of Embodying Products as Physical Exhibits	7-42

7.5.1.3	Motion to Bar Evidence that the Accused Infringer Has Patents of Its Own	7-42
7.5.1.4	Motion to Bar Argument that Patent Is Not Infringed Because It Is Invalid	7-43
7.5.2	Untimely Disclosures	7-43
7.5.2.1	Motion to Preclude Undisclosed Fact Witnesses	7-45
7.5.2.2	Motion to Preclude Undisclosed Prior Art	7-45
7.5.2.3	Motion to Preclude Untimely Expert Opinions	7-47
7.5.2.3.1	Opinions Not Disclosed in Reports	7-47
7.5.2.3.2	Affirmative Opinions Disclosed in Rebuttal Reports	7-48
7.5.2.3.3	Limit Experts to their Reports	7-48
7.5.3	Precluding Claims/Defenses	7-48
7.5.4	Miscellaneous Patent-Related Motions	7-50
7.5.4.1	Motion to Bar Evidence/Argument Inconsistent with Claim Construction	7-50
7.5.4.2	Motion to Preclude Reference to an Expert’s Contrary Claim-Construction Opinion	7-51
7.5.4.3	Motion to Bar Evidence/Argument about Dropped Claims/Patents	7-52
7.5.4.4	Motion to Bar Disclosure that the Patentee Seeks an Injunction	7-52
7.5.4.5	Motion to Preclude Reference to Related Proceedings in the Patent Office	7-53
7.5.4.6	Motion to Preclude Evidence Concerning Undisclosed Opinions of Counsel	7-55
7.5.4.7	Motion to Preclude Evidence Based on Estoppel Resulting from Post-Grant Proceedings	7-55
7.5.4.8	Motion to Preclude Reference to Presumption of Validity	7-56
7.5.4.9	Motion to Preclude Use of “Patent Troll” and Other Pejorative Terms Related to Nonpracticing Entities	7-57
Appendix 7.1	Sample Pretrial Order for Patent Cases	7-59
Appendix 7.2	Proposed Final Pretrial Order—Patent	7-63

Chapter 8 Trial

8.1	Procedural Issues	8-2
8.1.1	Separate Trials	8-3
8.1.1.1	Bifurcating Legal and Equitable Issues	8-4
8.1.1.1.1	When to Bifurcate	8-4
8.1.1.1.2	Use of an Advisory Jury	8-6
8.1.1.2	Separate Proceeding on Willfulness	8-6
8.1.1.3	Bifurcating Damages	8-7
8.1.1.4	Bifurcating Different Patents	8-7
8.1.1.5	Bifurcating Nonpatent Causes of Action	8-8
8.1.1.6	Bifurcating to Aid Juror Comprehension	8-9
8.1.2	Trial Logistics	8-9
8.1.2.1	Time Limits	8-10
8.1.2.1.1	Determining the Length of Trial	8-10
8.1.2.1.2	Allocation of Trial Time	8-11

8.1.2.1.2.1	Time Limits on Witness Examinations	8-11
8.1.2.1.2.2	Time Limits on Opening and Closing Statements	8-12
8.1.2.1.3	Modification of Time Limits	8-12
8.1.2.2	Procedures for the Presentation of Evidence	8-13
8.1.2.2.1	Trial Schedule	8-13
8.1.2.2.2	Order of Trial Presentations	8-14
8.1.2.2.2.1	Evidentiary and Witness Presentation	8-14
8.1.2.2.2.2	Closing Statements	8-15
8.1.2.2.2.3	Openness of Courtroom	8-15
8.1.2.2.2.3.1	Exclusion of Witnesses	8-15
8.1.2.2.2.3.2	Exclusion of Public	8-16
8.1.2.3	Procedures for Managing the Jury	8-16
8.1.2.3.1	Jury Selection and Voir Dire	8-16
8.1.2.3.2	Timing of Jury Instructions	8-17
8.1.2.3.2.1	Jury Admonitions	8-18
8.1.2.3.3	Juror Binders	8-19
8.1.2.3.4	Jury Note-Taking	8-19
8.1.2.3.5	Allowing Juror Questions	8-20
8.1.2.3.6	Transition Statements by Counsel to the Jury	8-20
8.1.2.3.7	Jury Education and Tutorials	8-21
8.1.2.4	Special Masters, Court-Appointed Experts, or Technical Advisors	8-21
8.2	General Evidentiary Issues	8-24
8.2.1	Witnesses	8-24
8.2.1.1	Patent Law Experts	8-24
8.2.1.2	Inventor and Other Technical Party Employee Testimony	8-25
8.2.2	Exhibits	8-26
8.2.3	Demonstratives	8-28
8.2.4	Limits on Attorney Argument	8-28
8.3	Specific Substantive Issues	8-28
8.3.1	Limitations on the Number of Asserted Claims	8-29
8.3.2	Indirect Infringement	8-30
8.3.3	Invalidity	8-31
8.3.3.1	Presumption of Validity	8-31
8.3.3.2	Obviousness	8-31
8.3.4	Patent Damages	8-33
8.3.4.1	Lost Profits	8-33
8.3.4.2	Reasonable Royalty	8-34
8.3.4.2.1	Royalty Base	8-35
8.3.4.2.2	Royalty Rate	8-36
8.3.4.2.2.1	Rejection of General, Simplistic Apportionment Rules	8-38
8.3.4.2.2.2	Consumer Surveys and Conjoint Analysis	8-38
8.3.4.2.2.3	FRAND/Standard Essential Patents	8-39
8.3.4.2.2.4	Indirect Infringement	8-40
8.4	Motions for Judgment as a Matter of Law	8-40
8.5	Jury Deliberations	8-41

8.5.1	Schedule of Deliberations	8-41
8.5.2	Claim-Construction Considerations	8-42
8.5.3	Jury Access to Evidence	8-42
8.5.3.1	Exhibits and Demonstratives	8-42
8.5.3.2	Testimony	8-42
8.5.3.3	Juror Questions During Deliberations	8-43
8.5.4	Verdict Forms	8-43
8.5.4.1	General Verdict Forms	8-43
8.5.4.2	Special Verdict Forms and Special Interrogatories	8-43
8.6	Bench Trials	8-44

Chapter 9 Posttrial

9.1	Entry of Judgment	9-1
9.2	Posttrial Motions	9-2
9.2.1	Permanent Injunctions	9-2
9.2.1.1	Issuing a Permanent Injunction	9-2
9.2.1.2	Ongoing Royalty After Denial of a Permanent Injunction	9-6
9.2.1.3	Motion for Contempt	9-8
9.2.2	Enhanced Damages	9-9
9.2.2.1	Timing	9-9
9.2.2.2	Standard	9-10
9.2.3	Attorneys' Fees	9-11
9.2.3.1	Timing	9-11
9.2.3.2	Standard	9-11
9.2.4	Motion for a New Trial	9-16
9.2.5	Renewed Motion for Judgment as a Matter of Law	9-17
9.2.6	Motion to Vacate Judgment in Connection with Settlement	9-18
9.3	Appeal	9-19
9.3.1	Stay of Injunction Pending Appeal	9-19
9.3.2	Remands	9-21

Chapter 10 ANDA and Biologics Cases: Patent Infringement Actions Involving FDA-Approved Drugs

10.1	Hatch-Waxman Act Statutory Scheme	10-2
10.1.1	Abbreviated New Drug Applications (ANDA) and Paragraph IV Certifications	10-4
10.1.2	Approval of ANDAs and First ANDA Filer's 180-Day Exclusive Marketing Period	10-7
10.1.3	The § 505(b)(2) Pathway for Drug Approval	10-9
10.2	The Hatch-Waxman Act's Impact on Patent Litigation	10-10
10.2.1	Personal Jurisdiction to Resolve Patent Issues in ANDA Cases	10-10
10.2.2	Subject-Matter Jurisdiction to Resolve Patent Issues in ANDA Cases	10-11
10.2.2.1	Jurisdiction over Infringement Actions by NDA Holders Arising from Paragraph IV Certifications	10-11
10.2.2.2	Declaratory Judgment Jurisdiction Arising from Paragraph IV Certifications	10-12

10.2.2.2.1	Declaratory Judgment Actions by First ANDA Filers	10-13
10.2.2.2.2	Declaratory Judgment Actions by Subsequent ANDA Filers	10-13
10.2.3	Case Management	10-14
10.2.3.1	Scheduling and Timing of Judgment	10-14
10.2.3.2	Order of Trial Presentation	10-15
10.2.3.3	Remedies in ANDA Litigation	10-16
10.2.3.4	Local Patent Rules in Hatch-Waxman Act Cases	10-16
10.2.3.5	Scheduling Orders in Hatch-Waxman Case Management: Chief Judge Stark, District of Delaware	10-18
10.2.4	Settlement of Hatch-Waxman Patent-Infringement Lawsuits	10-19
10.2.4.1	Reverse Payments (Pay-for-Delay Settlements)	10-19
10.2.4.2	Antitrust Issues with Reverse Payments Pre- <i>Actavis</i>	10-20
10.2.4.3	<i>FTC v. Actavis, Inc.</i> : Reverse-Payment Settlements May Be Anticompetitive	10-21
10.2.4.4	Hatch-Waxman Litigation Post- <i>Actavis</i> : Disputed Terms and Settlements	10-21
10.2.4.4.1	Legal Definitions of “Reverse Payment” and “Large”	10-22
10.2.4.4.2	FTC’s Role in Reverse-Payment Settlement Cases	10-23
10.2.4.4.3	State Antitrust Law’s Interaction with <i>Actavis</i>	10-24
10.3	Biologics and the BPCIA	10-24
10.3.1	Patent Infringement Actions Involving Biosimilar Products Under the BPCIA	10-24
10.3.2	The Biosimilar Application Pathway	10-25
10.3.2.1	Definition of a Biologic	10-26
10.3.2.2	The Pioneer Biologic License Application (BLA)	10-26
10.3.2.3	Period of Exclusivity for the Pioneering Company (“Reference-Product Exclusivity”)	10-26
10.3.2.4	Approval of the § 351(k) Biosimilar or Interchangeable BLA	10-27
10.3.3	Premarket Litigation Procedures Under § 351(l) of the Public Health Services Act (42 U.S.C. § 262(l))	10-28
10.3.3.1	Information Provided by the Biosimilar Applicant	10-30
10.3.3.2	Exchange of Patent Contentions	10-30
10.3.3.3	Supplementation of Patent Contentions	10-31
10.3.3.4	Selection of Patents for First Phase of Litigation	10-31
10.3.3.5	Litigation of the First-Phase Patents	10-32
10.3.3.6	Notice of Commercial Marketing and Second Phase of Litigation	10-32
10.3.3.7	Remedies	10-33
10.3.4	Current Cases Testing the Boundaries of the BPCIA Prelitigation Procedures	10-33
Appendix 10.1	Glossary of Hatch-Waxman-Related Terms	10-37
Appendix 10.2	ANDA Scheduling Order from Chief Judge Stark	10-39
Appendix 10.3	ANDA-Specific Local Patent Rules	10-47

Chapter 11 Design Patents

11.1	Substantive Law	11-2
11.1.1	Statutory Basis.....	11-2

11.1.2	Requirements for Patentability.....	11-2
11.1.2.1	Definition of a Design.....	11-2
11.1.2.2	Definition of an Article of Manufacture	11-2
11.1.2.3	Ornamentality.....	11-3
11.1.2.4	Inventorship	11-3
11.1.2.5	Double Patenting.....	11-4
11.1.3	Specification and Claim.....	11-4
11.1.3.1	The Design Patent Claim.....	11-5
11.1.3.2	Intersection of Design Patents and Related IP Laws	11-6
11.2	Case Management	11-7
11.2.1	Infringement	11-7
11.2.1.1	Ordinary Observer Test.....	11-9
11.2.1.2	Claim Construction.....	11-9
11.2.1.3	Product Scope	11-10
11.2.2	Invalidity.....	11-10
11.2.2.1	Functionality	11-10
11.2.2.2	Anticipation.....	11-11
11.2.2.3	Obviousness	11-11
11.2.3	Patent Local Rules	11-13
11.2.4	Remedies.....	11-13
11.2.4.1	Injunctive Relief.....	11-13
11.2.4.2	Damages.....	11-14

Chapter 12 Plant Patents

12.1	Substantive Law	12-2
12.1.1	Statutory Basis.....	12-2
12.1.1.1	Plant Patent Act.....	12-2
12.1.1.2	Plant Variety Protection Act.....	12-2
12.1.1.3	Utility Patents.....	12-3
12.1.2	The Plant Patent Claim.....	12-3
12.1.3	The PVP Certificate	12-3
12.1.4	Utility Patent Claims Related to Plants	12-4
12.2	Case Management	12-5
12.2.1	Plant Patents.....	12-5
12.2.1.1	Eligibility Requirements	12-5
12.2.1.2	Determination of Infringement of Plant Patents.....	12-5
12.2.1.2.1	Meaning of the Term “Variety”	12-6
12.2.1.2.2	Meaning of “Asexual Reproduction”	12-6
12.2.1.3	Invalidity of Plant Patents	12-7
12.2.1.3.1	Anticipation.....	12-7
12.2.1.3.2	Obviousness.....	12-8
12.2.1.4	Remedies under the Plant Patent Act	12-8
12.2.2	Plant Variety Protection	12-8
12.2.2.1	Determination of Infringement Under the PVPA.....	12-8
12.2.2.1.1	Essentially Derived Varieties.....	12-9

12.2.2.1.2 PVPA Exemptions.....	12-9
12.2.2.2 Invalidity of PVP Certificates	12-10
12.2.2.3 Remedies Under the PVPA.....	12-10
12.2.3 Utility Patent Issues Related to Plants.....	12-11
12.2.3.1 Patent Exhaustion.....	12-11
12.2.3.2 Patent Misuse	12-11
12.2.3.3 Indirect Infringement	12-12
12.2.4 Other Plant-Related IP Issues: Variety Names and Trademarks.....	12-12

Chapter 13 Patent Suits Against the United States

13.1 Introduction.....	13-1
13.1.1 Legal Foundation.....	13-1
13.1.2 United States Court of Federal Claims	13-2
13.1.2.1 History	13-2
13.1.2.2 General Statistics	13-3
13.2 Jurisdiction	13-3
13.2.1 Scope of § 1498	13-3
13.2.1.1 Historical Development	13-3
13.2.1.2 Authorization and Consent	13-4
13.2.2 Interplay with District Court Jurisdiction	13-6
13.2.2.1 Section 1500’s Bar on Simultaneous Suits	13-6
13.2.2.2 Section 1498 as a Defense	13-6
13.3 Substantive Differences Between Patent Suits in District Court and the Court of Federal Claims	13-7
13.3.1 Infringement	13-7
13.3.2 Third-Party Practice	13-7
13.3.3 Damages	13-8
13.3.4 Costs and Attorney Fees	13-9
13.4 Early Case Management	13-9
13.5 Discovery	13-10

Chapter 14 Patent Law Primer

14.1 The Patent	14-5
14.1.1 The Patent Document	14-5
14.1.1.1 The First Page—Administrative Details	14-7
14.1.1.2 Drawings	14-7
14.1.1.3 The Specification	14-7
14.1.1.3.1 Claims	14-7
14.2 Patent Prosecution and the Patent Lifecycle	14-9
14.2.1 Institutional Aspects	14-9
14.2.1.1 The Patent Office	14-9
14.2.1.2 The Patent Bar	14-10
14.2.1.3 The Patent Trial and Appeal Board (PTAB)	14-10
14.2.1.4 Laws Governing the USPTO and the Manual of Patent Examining Procedure (MPEP)	14-11

14.2.2	Filing a Patent Application	14-11
14.2.2.1	Overview of Patent Examination	14-11
14.2.2.2	The Application	14-12
14.2.2.2.1	Elements of a Nonprovisional Patent Application	14-12
14.2.2.2.2	Disclosure of Prior Art	14-13
14.2.2.2.2.1	Prior Art Disclosure by Applicant—Information Disclosure Statement	14-13
14.2.2.2.2.2	Prior Art Disclosure by Third Parties—Preissuance Submissions	14-13
14.2.2.2.3	Priority Date	14-13
14.2.2.2.4	Nonstandard Applications	14-13
14.2.2.3	Restriction Requirements and Divisional Applications	14-14
14.2.2.4	Publication	14-14
14.2.3	The Prosecution History or “File Wrapper”	14-15
14.2.3.1	Office Actions	14-15
14.2.3.1.1	Affidavits	14-15
14.2.3.1.2	Interview Report	14-15
14.2.3.2	Request for Continued Examination (RCE)	14-16
14.2.3.3	Continuation Applications	14-16
14.2.3.4	Continuation-in-Part (CIP) Applications	14-16
14.2.3.5	PTO Petition and Appeals	14-17
14.2.4	Patent Duration	14-17
14.2.4.1	Patent-Term Adjustments	14-18
14.2.4.2	Patent-Term Restoration	14-18
14.2.5	Postissuance Corrections and Administrative Proceedings	14-18
14.2.5.1	Disclaimers	14-18
14.2.5.2	Certificate of Correction	14-19
14.2.5.3	Supplemental Examination	14-19
14.2.5.4	Reissue	14-20
14.2.5.4.1	Narrowing Reissues	14-21
14.2.5.4.2	Broadening Reissues	14-21
14.2.5.4.2.1	The Recapture Rule	14-21
14.2.5.4.2.2	Intervening Rights	14-22
14.2.5.5	Reexamination	14-23
14.2.5.5.1	The Reexamination Process	14-23
14.2.5.5.2	Ex Parte Reexamination	14-24
14.2.5.5.3	Inter Partes Reexamination	14-24
14.2.5.5.4	Reexamination and Concurrent Litigation	14-24
14.2.5.6	Inter Partes Review (IPR)	14-25
14.2.5.7	Postgrant Review (PGR)	14-26
14.2.5.7.1	Covered Business-Method Review (CBMR)	14-26
14.2.5.7.2	Postgrant, Inter Partes, and Covered Business-Method Review and Concurrent Litigation	14-27
14.2.6	The Presumption of Validity	14-28
14.3	Validity	14-29
14.3.1	Patentable Subject Matter (§ 101)	14-29

14.3.1.1	Modern Core Principles: Ineligible Subject Matter and Inventive Application	14-30
14.3.1.2	The Evolution of Patentable Subject-Matter Limitations	14-31
14.3.1.2.1	Early Development of Patent-Eligibility Limitations	14-32
14.3.1.2.2	<i>Funk Brothers</i> (1948): The Emergence of Inventive Application ...	14-34
14.3.1.2.3	The New Technological Age	14-36
14.3.1.2.4	The Rise of the Federal Circuit and Dismantling of Patentable Subject-Matter Limitations	14-40
14.3.1.2.5	The Supreme Court’s Revival of Subject-Matter Limitations	14-41
14.3.1.3	Patent-Eligibility Conundrums	14-44
14.3.1.4	Subject Matter Expressly Excluded by Statute	14-45
14.3.1.4.1	Tax Strategies	14-45
14.3.1.4.2	Human Organisms	14-45
14.3.2	Utility (§ 101)	14-45
14.3.3	Disclosure (§ 112)	14-46
14.3.3.1	Written Description	14-47
14.3.3.1.1	Policing Continuation Practice	14-47
14.3.3.1.2	Biotechnology Patents	14-48
14.3.3.2	Enablement	14-48
14.3.3.3	Best Mode	14-50
14.3.3.4	Claim Definiteness	14-50
14.3.4	Novelty and Statutory Bars (§ 102)	14-51
14.3.4.1	The First-to-Invent Regime	14-51
14.3.4.1.1	First to Invent—§ 102(a)	14-52
14.3.4.1.1.1	“Known or Used”	14-53
14.3.4.1.1.2	Printed Publication	14-53
14.3.4.1.2	Novelty—First to Invent—§ 102(g)	14-54
14.3.4.1.2.1	Conception	14-55
14.3.4.1.2.2	Reduction to Practice	14-55
14.3.4.1.2.3	Reasonable Diligence	14-56
14.3.4.1.2.4	Abandoned, Suppressed, or Concealed	14-56
14.3.4.1.2.5	Section 102(g)—Summary	14-56
14.3.4.1.3	Novelty—“Secret Prior Art”—§ 102(e)	14-57
14.3.4.1.4	Novelty—Derivation—§ 102(f)	14-57
14.3.4.1.5	Statutory Bars—Timely Filing—§ 102(b)	14-57
14.3.4.1.5.1	Experimental Use	14-58
14.3.4.1.5.2	On Sale Bar	14-58
14.3.4.1.6	Statutory Bars—Abandonment—§ 102(c)	14-60
14.3.4.1.7	Statutory Bars—International Filing—§ 102(d)	14-60
14.3.4.2	The First-to-File Regime	14-60
14.3.4.2.1	Novelty and Prior Art—§ 102(a)	14-60
14.3.4.2.2	Novelty—Grace Period and Exceptions to Prior Art—§ 102(b)	14-61
14.3.4.2.3	Novelty—Joint Research—§ 102(c)	14-62
14.3.4.2.4	Effective Date of Patent Prior Art—§ 102(d)	14-63
14.3.4.2.5	Derivation Proceedings	14-63

14.3.5	Nonobviousness—§ 103	14-63
14.3.5.1	Historical Development	14-63
14.3.5.2	Nonobviousness Standard	14-64
14.3.5.2.1	Nonobviousness Under the First-to-Invent Regime	14-64
14.3.5.2.2	Nonobviousness Under the First-to-File Regime	14-65
14.3.5.3	Applying § 103	14-65
14.3.5.3.1	Determining the Level of Ordinary Skill in the Art	14-65
14.3.5.3.2	Scope and Content of the Prior Art	14-67
14.3.5.3.3	Differences Between Invention and Prior Art	14-68
14.3.5.3.4	Secondary Considerations	14-68
14.3.5.3.4.1	Long-Felt Need and Failure by Others	14-69
14.3.5.3.4.2	Awards and Praise	14-69
14.3.5.3.4.3	Skepticism, “Teaching Away,” and Unexpected Results	14-69
14.3.5.3.4.4	Licensing Activity	14-70
14.3.5.3.4.5	Copying	14-70
14.3.5.3.4.6	Commercial Success	14-70
14.3.5.3.5	The Ultimate Conclusion and Combining References	14-70
14.3.6	Inventorship	14-75
14.3.6.1	Inventive Entities	14-76
14.3.6.2	Default Rights of Owners	14-76
14.3.6.3	Correction of Inventorship	14-76
14.4	Enforcement: Infringement, Defenses, and Remedies	14-77
14.4.1	Infringement	14-77
14.4.1.1	Section 271	14-77
14.4.1.2	Direct Infringement	14-77
14.4.1.3	Indirect Infringement	14-77
14.4.1.3.1	Inducement	14-78
14.4.1.3.2	Contributory Infringement	14-79
14.4.1.3.3	Joint Infringement	14-79
14.4.1.4	Infringement Analysis	14-80
14.4.1.4.1	Literal Infringement	14-80
14.4.1.4.1.1	Interpreting the Literal Scope of Means-Plus-Function Claims (§ 112(f))	14-80
14.4.1.4.1.1.1	Determining Whether a Claim Limitation Is Governed by § 112(f)	14-81
14.4.1.4.2	Nonliteral Infringement—The Doctrine of Equivalents	14-82
14.4.1.4.2.1	Limiting Principles	14-82
14.4.1.4.2.1.1	The All-Elements (All-Limitations) Rule	14-83
14.4.1.4.2.1.1.1	Claim Vitiating	14-83
14.4.1.4.2.1.2	Prosecution History Estoppel	14-83
14.4.1.4.2.1.2.1	Specific Exclusion	14-85
14.4.1.4.2.1.3	Prior Art Rule	14-85
14.4.1.4.2.1.4	The Public Dedication Rule	14-86
14.4.1.4.2.2	Interpreting the Nonliteral Scope of Means-Plus-Function Claims	14-86
14.4.1.4.3	The Reverse Doctrine of Equivalents	14-87

14.4.1.5	Extraterritorial Infringement	14-88
14.4.1.5.1	Manufacturing Components Within the United States for Assembly Abroad—§ 271(f)	14-88
14.4.1.5.2	Importing Products Made Using Patented Processes—§ 271(g)	14-89
14.4.2	Defenses	14-89
14.4.2.1	Noninfringement	14-89
14.4.2.2	Absence of Liability	14-89
14.4.2.2.1	Consent or License	14-89
14.4.2.2.1.1	First Sale Doctrine/Exhaustion Principle	14-90
14.4.2.2.1.2	Shop Right	14-91
14.4.2.2.2	Experimental Use Defense	14-91
14.4.2.2.3	Prior-Use Right	14-92
14.4.2.2.4	Bar Against Remedies for Infringement of Medical Procedure Patents by Doctors and Hospitals	14-92
14.4.2.2.5	Sovereign Immunity	14-93
14.4.2.3	Unenforceability	14-93
14.4.2.3.1	Inequitable Conduct	14-93
14.4.2.3.2	Patent Misuse	14-94
14.4.2.3.2.1	Postexpiration Royalties	14-95
14.4.2.3.3	Equitable Estoppel	14-95
14.4.2.3.4	Laches	14-96
14.4.2.3.4.1	Prosecution Laches	14-96
14.4.2.4	Invalidity	14-97
14.4.2.4.1	Double Patenting	14-97
14.4.2.4.1.1	Statutory, or Same-Invention	14-97
14.4.2.4.1.2	Nonstatutory, or Obviousness-Type	14-98
14.4.2.4.2	Estoppel by Transfer of Ownership	14-98
14.4.2.4.2.1	Assignor Estoppel	14-98
14.4.2.4.2.2	No Licensee Estoppel	14-99
14.4.2.4.2.3	Assignee Estoppel	14-100
14.4.2.5	Antitrust Counterclaims	14-100
14.4.3	Remedies	14-101
14.4.3.1	Injunctive Relief	14-101
14.4.3.1.1	Preliminary Injunction	14-101
14.4.3.1.2	Permanent Injunction	14-102
14.4.3.2	Damages	14-103
14.4.3.2.1	Compensatory Damages	14-103
14.4.3.2.1.1	Lost Profits	14-103
14.4.3.2.1.2	Convoyed Sales	14-104
14.4.3.2.1.3	Price Erosion	14-104
14.4.3.2.1.4	Reasonable Royalty	14-104
14.4.3.2.1.4.1	Damages Theories	14-106
14.4.3.2.1.4.2	FRAND Licensing of Standard Essential Patents	14-109
14.4.3.2.1.5	Marking	14-110
14.4.3.2.2	Enhanced Damages	14-111

Patent Case Management Judicial Guide, Third Edition

14.4.3.2.3 Prejudgment Interest	14-112
14.4.3.3 Costs	14-112
14.4.3.4 Attorneys' Fees	14-112
14.5 Other Patent-Related Causes of Action	14-113
14.5.1 False Marking	14-113
14.5.2 Civil Actions Under §§ 145 and 146	14-113
14.6 Appeals and Parallel Litigation	14-114
14.6.1 Appeals to the Federal Circuit	14-114
14.6.1.1 Appellate Jurisdiction	14-114
14.6.1.2 Choice of Law	14-114
14.6.1.3 Interlocutory Appeals	14-116
14.6.2 Parallel Litigation Forums	14-116
14.6.2.1 International Trade Commission	14-116
14.6.2.2 Patent Office Reexamination or Review	14-117
14.6.2.3 Other District Courts and MDL Proceedings	14-117
14.6.2.4 Foreign Courts	14-117
Appendix A: Glossary	
Appendix B: Acronyms	
Appendix C: Patent Resources	
Appendix D: Patent Local Rules	
Appendix E: Model Patent Jury Instructions	
Table of Cases	
Author Biographies	

Foreword to Third Edition

Patent cases present unique and often daunting challenges for federal judges. The statutory law is complex, and appellate authority interpreting the relevant statutes constantly is evolving. Patent cases have their own peculiar nomenclature in which even the most diligent judges typically require a considerable amount of time to become fluent. And the exponential growth of new technologies has made the subject matter of many patent cases difficult for judges without a technical background to understand, at least to the point at which they have confidence in their decisions.

In addition to these challenges, patent cases also can present significant issues with respect to case management. The financial and competitive stakes often are extraordinarily high, and counsel tend to be correspondingly talented, active, and numerous. The major elements of most patent litigation, including discovery disputes, claim-construction hearings, dispositive motion practice, and trial, usually are intense affairs that test both the intellect and interpersonal skills of the judges who preside over them.

This outstanding, comprehensive judicial guide to the management of patent cases is the latest product of an eighteen-year collaboration between the Federal Judicial Center and the Berkeley Center for Law and Technology at the University of California—Berkeley School of Law. In addition to three editions of the guide, the results of that collaboration have included an annual seminar that has trained hundreds of federal judges in the fundamentals of intellectual property law and frequent special-focus programs on relevant legal developments. Under the visionary leadership of Professor Peter Menell, and with the assistance of a superb group of distinguished practitioners, the Berkeley Center has provided an invaluable service to the federal judiciary.

Jeremy D. Fogel
Senior District Judge
Director, Federal Judicial Center (2011–)

Foreword to First Edition

This judicial guide on patent case management is a collaborative effort between the Federal Judicial Center and the Berkeley Center for Law & Technology of the University of California–Berkeley School of Law. This collaboration began in 1998 when the Berkeley Center and the Judicial Center conducted their first intellectual property seminar for judges. That seminar was structured to provide district judges with a background and understanding of the many areas of intellectual property law. From that initial program has evolved an annual intellectual property seminar for judges at the Berkeley Center as well as a range of innovative intellectual property programs at the Federal Judicial Center’s national and local workshops.

Then and now, the driving force behind these judicial education efforts in intellectual property has been Professor Peter Menell, Director of the Berkeley Center. Building on the enormous success of these programs, Professor Menell approached the Center several years ago with the idea of collecting materials on patent case management that had been compiled for the intellectual property seminars. With coauthors Lynn Pasahow, James Pooley, and Matthew Powers, along with the assistance of a distinguished group of collaborators and advisors, Professor Menell prepared this comprehensive guide. I believe this guide will be a valuable aid to judges handling the complex arena of patent cases

Barbara J. Rothstein
District Judge
Director, Federal Judicial Center (2003–2011)

Preface to the Third Edition

The patent system and patent case management continue to evolve rapidly. This edition encompasses implementation of the America Invents Act (AIA), the emergence of review proceedings at the Patent Trial and Appeal Board (PTAB), the Supreme Court's many recent patent decisions (patent eligibility, claim construction, claim indefiniteness, infringement analysis (rejecting "joint infringement"), the intent requirement for induced infringement liability (rejecting a defense of good-faith belief of a patent's invalidity), and attorneys' fees), and the Federal Circuit's damages jurisprudence, including damage awards for standard essential patents (SEP) licensed pursuant to fair, reasonable, and nondiscriminatory (FRAND) terms. It also includes case-management checklists, model case-management orders, and other materials developed by district judges and advisory bodies for streamlining patent case management. Finally, this volume adds a chapter on patent litigation at the Court of Federal Claims.

Preface to the Second Edition

As indicated in the preface to the First Edition of the Patent Case Management Judicial Guide (PCMJG), we committed to revise this volume on a biennial basis. And indeed, the patent system experienced substantial change during the ensuing two years. The Supreme Court and the Federal Circuit had issued a raft of important patent law decisions. In addition, many district courts had adopted and revised Patent Local Rules and begun implementation of the Patent Pilot Program.

Just as we were about to release the Second Edition of the PCMJG last fall, Congress passed the America Invents Act (AIA). By the time that we had written up the ramifications of that multi-faceted law for patent case management, the Supreme Court had rendered its decision in *Mayo Collaborative Servs. v. Prometheus Labs., Inc.*, 132 U.S. 1289 (2012). Other important decisions from the courts have continued apace.

These developments amply demonstrate that the patent system operates in an active seismic zone. This should not be surprising in view of the rapid advances in information and biomedical technologies and the desire of the various patent institutions to adapt patent law in response to the shifting tectonic plates.

As a result, this volume substantially updates and expands the coverage and analysis of patent case management practices. We remain committed to updating the volume on a biennial basis, although we and the courts need to be mindful of the unpredictability of living in an earthquake-prone environment.

Preface to the First Edition

As the number, size, and complexity of patent cases have grown throughout the United States over the past several decades—paralleling expansion in the role of high technology enterprises in the U.S. economy—the need for a comprehensive, user-friendly, and practical judicial guide for managing patent cases has become increasingly apparent. Although similar in many respects to other forms of complex civil litigation, patent cases pose distinctive case-management challenges. Patent cases feature complex and dynamic technological facts to a degree rarely encountered in most other areas of litigation. Furthermore, they employ unique procedures (such as claim construction hearings) that affect and interact with other aspects of the case (such as summary judgment motions and expert reports) in ways that create unusual scheduling and substantive complexity. In addition, patent cases often entail distinctive and difficult discovery issues, extensive use of experts, and particularly complex dispositive and pretrial motion practice.

Because of the decentralized, general jurisdiction structure of federal courts in the United States, much of the experience relating to managing patent cases is siloed in particular judicial chambers. As one jurist aptly noted, best practices for patent case management have been transmitted largely through word of mouth. Given the crowded, diverse dockets of federal courts, the accessibility and reliability of such knowledge is far from ideal. Judges in some districts have partially codified recommended practices in the form of Patent Local Rules, standing orders, and patent jury instructions, but these documents do not address the full range of distinctive challenges posed by patent litigation. Furthermore, such judicial wisdom continues to evolve.

Recognizing these patterns, the authors undertook in 2006 to survey the range of approaches and perspectives on patent case management, foster discussion and analysis of patent case management techniques, and develop an authoritative guide for judges, law clerks, practitioners, and patent and civil procedure professors and scholars. This project grew out of an annual series of intellectual property education programs that Professor Peter Menell has organized since 1998 for the Federal Judicial Center. It began by collecting available materials relating to patent case management and constructing a comprehensive outline. Over the next year, the team drafted, revised, and edited the principal chapters of the guide. They first vetted a draft at the FJC intellectual property conference in June 2007. They then undertook a substantial revision of the manuscript. Between December 2007 and August 2008, the authors met with district judges and magistrate judges in the most active patent jurisdictions around the nation—the Northern District of California, the Central District of California, the District of Delaware, the Northern District of Illinois, the District of New Jersey, the Southern District of New York, the Eastern District of Texas, and the Eastern District of Virginia—as well as the Federal Circuit to discuss the overall project and refine the specific case-management recommendations. Such sessions explored the range of practices and honed the best practices set forth in this Guide. The authors also assembled an advisory board of leading patent litigators and academics to provide input on the project.

Given the dynamism of the patent system and patent litigation, the authors plan to revise the guide on a biennial basis.

Acknowledgments

This project could not have reached fruition without the support and encouragement of the Federal Judicial Center and the Berkeley Center for Law & Technology. We are especially grateful to the many federal judges, practitioners, and professors who have provided insights and guidance on patent case management.

First Edition: We thank Nicholas Brown, Thomas Fletcher, and Sue Vastano Vaughan for their contributions; James Morando and Ted Sichelman for detailed comments; Ashley Doty, Blake Greene, Tamar Gubins, David Haskel, Justin Lee, Will McGinty, Hersh Reddy, and Jeff Thomas for excellent research assistance; David Grady and Jennifer Zahgkuni for their assistance in editing and formatting; and Laura Rochelois and the studio of By Design Legal Graphics for their assistance with figure illustrations.

Second Edition: We are grateful to David S. Bloch, Jeremy Bock, Anita Choi, Samuel Ernst, Thomas Fletcher, Rebecca Charnas Grant, Leeron G. Kalay, Clem Roberts, Kimberly N. Van Voorhis, Michael R. Ward, and Patricia Young for contributions; and Damion Jurrens, Benjamin Petersen, Roman A. Swoopes, Priscilla Grace Taylor, and Cecilia Ziniti for excellent research assistance.

Third Edition: We are grateful to Thomas Fletcher, Lisa Pirozzolo, and Mark Selwyn for comments; Danielle Goldstein, Nicholas Ham, Alexa Hansen, Alessa Phang, Brett M. Sandford, Gregory K. Sobolski, Ranganath Sudarshan, and Jonathan Tamimi for excellent research assistance; and LegalMetrics and Lex Machina for data.

JUDICIAL ADVISORY BOARD

Hon. Jeremy D. Fogel
District Judge
Northern District of California
Director, Federal Judicial Center

Hon. Cathy Ann Bencivengo
District Judge
Southern District of California

Hon. Susan G. Braden
Judge
Court of Federal Claims

Hon. James Rodney Gilstrap
District Judge
Eastern District of Texas

Hon. Paul Singh Grewal
Magistrate Judge
Northern District of California

Hon. Andrew J. Guilford
District Judge
Central District of California

Hon. Kathleen M. O'Malley
Circuit Judge
Court of Appeals for the Federal Circuit

Hon. Jerome Simandle
Chief Judge
District of New Jersey

Hon. Leonard P. Stark
Chief Judge
District of Delaware

Hon. Ronald M. Whyte
Senior District Judge
Northern District of California

ADR ADVISORY BOARD

Hon. Garrett Brown
District Judge (ret.)
District of New Jersey

Hon. David Folsom
District Judge (ret.)
Eastern District of Texas

Hon. Faith S. Hochberg
District Judge (ret.)
District of New Jersey

Hon. James F. Holderman
District Judge (ret.)
Northern District of Illinois

Hon. Edward Infante
Magistrate Judge (ret.)
Northern District of California

ACADEMIC AND PRACTITIONER ADVISORY BOARD

Jared Bobrow
Weil, Gotshal & Manges LLP

Colleen Chien
Santa Clara University School of Law

Morgan Chu
Irell & Manella LLP

Dennis Crouch
University of Missouri School of Law

Robin Feldman
Harry & Lillian Hastings
Professor of Law
UC Hastings College of the Law

John M. Golden
Loomer Family Professor in Law
University of Texas School of Law

Michael A. Jacobs
Morrison & Foerster LLP

Mark D. Janis
Robert A. Lucas Chair of Law
Maurer School of Law
Indiana University

William F. Lee
Wilmer Cutler Pickering
Hale & Dorr LLP

Mark A. Lemley
William H. Neukom Professor of Law
Stanford Law School
Durie Tangri LLP

Sonal Mehta
Durie Tangri LLP

Robert P. Merges
Wilson, Sonsini, Goodrich & Rosati
Professor of Law
University of California, Berkeley School
of Law

Arti K. Rai
Elvin R. Latty Professor of Law
Duke Law School

Clement S. Roberts
Durie Tangri LLP

David L. Schwartz
Northwestern University School of Law

Ted Sichelman
University of San Diego School of Law

Chapter 1

Overview of the Patent System and General Principles for Effective Patent Case Management

1.1	Overview of the Patent System	2
1.1.1	Origins and Purposes	2
1.1.2	Evolution of the Patent System	5
1.1.2.1	Patent Act of 1952	8
1.1.2.2	America Invents Act of 2011	9
1.1.2.3	Deciphering and Interpreting Patent Law	11
1.1.3	Patent Institutions	12
1.1.3.1	The Patent Office	12
1.1.3.2	The Court of Appeals for the Federal Circuit	13
1.1.3.3	The International Trade Commission	14
1.1.3.4	The Marketplace for Patents and Patent Litigation	14
1.2	A Preliminary Note About Settlement of Patent Cases	15

District court judges have extensive experience managing a wide range of complex litigation. Furthermore, multivolume treatises and law review articles comprehensively examine the substance of patent law. This guide does not attempt to replace either body of wisdom. Rather, it systematically explains and analyzes the judicial management of patent litigation.

Patent cases present distinctive management challenges and thus can benefit from a comprehensive framework of principles and methods tailored to contemporary practices. In addition to featuring complex and dynamic technological facts to a degree rarely encountered in most other areas of litigation, patent cases employ unique procedures (such as claim-construction hearings) that affect and interact with other aspects of the case (such as summary judgment motions and expert reports) in a way that creates unusual scheduling and substantive complexity. They also often proceed in parallel with proceedings involving the same patented technology in other tribunals—including the Patent Trial and Appeal Board (PTAB), International Trade Commission (ITC), other district courts, and courts outside of the United States. Patent cases also frequently raise difficult discovery issues, including patent-specific privilege and waiver questions. The number of potentially dispositive issues (both legal and equitable) makes patent case management particularly challenging. Furthermore, the landscape of patent litigation evolves rapidly due to advances in technology, shifts in the law, and changes in business strategy. The Supreme Court has been especially active in hearing patent cases over the past decade. Congress has also been active in reforming patent law, especially as it relates to case management.

Several of the Supreme Court's recent decisions have substantially expanded district judges' discretion in managing patent cases. The Court's decision in *eBay Inc. v. MercExchange, LLC*, 547 U.S. 388 (2006), interpreted the Patent Act to afford district judges significant leeway in awarding equitable relief. The Court's decisions in *Bilski v. Kappos*, 561 U.S. 593 (2010), *Mayo Collaborative Services v. Prometheus Laboratories, Inc.*, 132 S. Ct. 1289 (2012), *Association for Molecular Pathology v. Myriad Genetics, Inc.*, 133 S. Ct. 2107 (2013), and *Alice Corp. Pty. Ltd. v. CLS Bank Internation-*

al, 134 S. Ct. 2347 (2014), reinvigorate doctrines limiting patent eligibility, which has produced a raft of early dispositive motions. The Court's decisions in *Octane Fitness LLC v. Icon Health & Fitness, Inc.*, 134 S. Ct. 1749 (2014), and *Highmark Inc. v. Allcare Health Management System, Inc.*, 134 S. Ct. 1744, 1749 (2014), afford district judges greater discretion in awarding attorney fees. In *Teva Pharmaceuticals USA, Inc. v. Sandoz, Inc.*, 135 S. Ct. 831 (2015), the Court held that patent claim construction can entail subsidiary factual findings, expanding the role for evidentiary hearings in the claim-construction process. Furthermore, recent Federal Circuit decisions have expanded district judges' gatekeeping role in limiting damage theories and evidence. See *Apple, Inc. v. Motorola, Inc.*, 757 F.3d 1286 (Fed. Cir. 2014); *Uniloc USA, Inc. v. Microsoft Corp.*, 632 F.3d 1292 (Fed. Cir. 2011). At the same time, the rapid rise in streamlined postgrant review proceedings, established by the America Invents Act of 2011 (AIA), as well as the AIA's misjoinder provision (§ 299) have posed new challenges for managing patent cases. The contours of these doctrinal and procedural shifts are still being fleshed out through case-by-case adjudication.

This guide seeks to assist district court judges in surmounting the distinctive challenges of managing patent litigation. It combines the collective experience of leading patent jurists and attorneys from hundreds of patent cases and scores of patent trials to balance the perspectives of both patent holders and accused infringers. The rich variety of cases and rapidly evolving patent ecosystem require broad knowledge of the available tools. Rather than present a formulaic approach, this treatise sets forth and explores a wide range of options for the most common issues. It provides guidance on which factors make particular options preferable in certain circumstances. It also includes draft orders and exemplar case-management documents to illustrate case-management tools and strategies. It emphasizes and places in perspective those issues of greatest importance to trial courts.

1.1 Overview of the Patent System

Before turning to the details of patent case management, it is worthwhile examining the history, purposes, institutions, and economic factors that undergird the patent system and patent litigation.

1.1.1 Origins and Purposes

The U.S. patent system grows out of the early English Statute of Monopolies (1623), which prohibited the Crown from arbitrarily issuing letters patent "to court favorites in goods or businesses" while authorizing grants of exclusive rights to the "working or making of any manner of new Manufacture." 21 Jam. 1, c. 3, §§ 1, 6 (1623); see also *Graham v. John Deere Co. of Kan. City*, 383 U.S. 1, 5 (1966). In so doing, the Statute of Monopolies promoted free-market competition while addressing the appropriability problem that plagues technology markets: the difficulty in recovering the costs of research and development (R&D) and earning a fair return on the inherently risky investments in innovation.

In a competitive marketplace without protection for technological advances, inventors and entrepreneurs can encounter difficulty profiting from R&D investments. To the extent that they succeed in building a better device, process, or composition of matter, competitors can often quickly imitate the innovation without bearing the upfront R&D costs. These competitors can then undercut the innovator's price, pushing the market-clearing price toward the marginal cost of production (without consideration of R&D costs). Thus, unless the inventor/entrepreneur can protect their R&D costs in another way—for example, through trade secrecy—the motivation to engage in R&D will be below the social optimum. Trade secrecy, however, will only succeed for the limited set of technological advances—such as some process inventions—that do not reveal their inventive insights in the product that is sold in the marketplace. In addition, trade secrets can be difficult to enforce. Once the secret leaks, those who learn it through other than improper means are free to compete. Furthermore, trade secrecy slows dissemination of knowledge, which is vital to technological progress. The Statute of Monopolies sought to counteract this dilemma and thereby promote technological progress by affording exclusive rights to “working or making of any manner of new Manufacture” for limited times in exchange for disclosure of inventions.

Drawing on this framework, the founders of the United States authorized Congress to enact laws “[t]o promote the Progress of Science and useful Arts, by securing for limited Times to Authors and Inventors, the exclusive Right to their respective Writings and Discoveries.” U.S. Const. art. I, § 8, cl. 8. In the nation's first State of the Union address, President Washington urged the Congress to exercise this power:

The advancement of agriculture, commerce, and manufactures, by all proper means, will not, I trust, need recommendation. But I cannot forbear intimating to you the expediency of giving effectual encouragement as well to the introduction of new and useful inventions from abroad, as to the exertions of skill and genius in producing them at home . . .

George Washington, State of the Union Address, Journal of the Senate, 1st Cong., 2d Sess. 5 to 8 (Jan. 8, 1790). Congress enacted the first patent law soon after the nation was formed, declaring that anyone who had “invented or discovered any useful art, manufacture, engine, machine, or device, or any improvement therein not before known or used” shall have “the sole and exclusive right and liberty of making, constructing, using and vending to others to be used” for a term not to exceed fourteen years. Patent Act of 1790, Ch. 7, 1 Stat. 109-112. Although revised by Congress on several occasions over the next two and a quarter centuries, this terse formulation has remained the core of the patent system. Court decisions stretching back to the nineteenth century form an important source of patent law even today, as reflected in the Supreme Court's decision in *Mayo Collaborative Services v. Prometheus Laboratories, Inc.*, 132 S. Ct. 1289, 1293 (2012) (drawing on *Le Roy v. Tatham*, 55 U.S. (14 How.) 156 (1853), and *O'Reilly v. Morse*, 56 U.S. 62 (1853) to address the scope of patentable subject matter).

Therefore, it is important to understand the principles and policies undergirding the patent system. The most basic of these is the constitutional purpose: “To Promote Progress of . . . useful Arts.” Patent law represents an important exception to

the free-market system on which the United States of America was built. The founders were skeptical of government-bestowed privileges and monopolies. However, they recognized that without protection against unauthorized imitation, many inventors would lack adequate incentives to invest their resources and labors in inventive activities because second-comers could easily imitate successful discoveries without incurring the risk and cost of innovation. Patent law was enacted to ensure that those who make significant inventive contributions receive a reward that is at least roughly commensurate with the costs and risks of inventive activity. As President Abraham Lincoln, the recipient of U.S. Patent No. 6,469 (“A Device for Buoying Vessels Over Shoals”), would later remark, “the patent system added the fuel of interest to the fire of genius.” See Abraham Lincoln, *Lecture on Discoveries and Inventions, Jacksonville, Illinois (Feb. 11, 1859)*, in *Lincoln: Speeches and Writings 1859–1865* 3, 1011 (Don E. Fehrenbacher ed., 1989). The “fuel of interest” connotes the financial investment needed to stoke inventors’ imagination and experimentation.

The founders also believed the ultimate beneficiary of such efforts should be the public, and thus limited the duration of patents to roughly the amount of lead time necessary to recoup the inventor’s investment. In effect, the original term of fourteen years, borrowed from the English patent system, was double the seven-year term of trade guild apprenticeships dating back to the Middle Ages. Various other doctrines—such as the nonobviousness standard, disclosure requirements, infringement tests, statutory and judge-made defenses, the patent misuse doctrine, and remedy provisions—seek to ensure that the reward to the patentee is not disproportionate to the contribution to the prior art and maximizes the net public benefit.

A related principle of patent law is the notion that the patent represents a bargain between the inventor and the public. The public affords the patentee exclusive rights to prevent others from making, using, or selling the invention in exchange for fully and forthrightly disclosing the invention. In this way, the public can practice the invention following the patent’s expiration and learn from the knowledge disclosed even during the term of the patent. Thus, U.S. patent law requires a sufficient disclosure to ensure that the inventor “possessed” the claimed invention and to enable others to build or use it later. This quid pro quo serves to promote progress by spurring cumulative innovation—enabling subsequent inventors to stand on the shoulders of their predecessors.

This bargain encourages inventors to disclose their inventions, which promotes the advancement of scientific knowledge and follow-on improvements and invention. In a world without patent protection, innovators would keep more innovative activity secret to discourage free riders, at least temporarily, thus depriving the public of the benefit of disclosure, which can help spur further innovation. Even before a patent expires, pioneering inventors and competitors can seek patents on improvements of patented technologies. They might have to license underlying patents or wait for those patents to expire to enter the market, but the public nonetheless can potentially benefit from more rapid technological advances and diffusion of knowledge.

The patent system also seeks to provide the public (including potential competitors and inventors) adequate notice of the boundaries of patent claims so that they can pursue competing projects without undue fear of encroaching upon the patentee's exclusive rights. In some areas of technology, this principle is especially difficult to apply owing to the inherent ambiguity of language. Unlike the metes and bounds of real property deeds—which can be objectively assessed by trained land surveyors—patent claims rarely trace intangible rights boundaries with complete precision. Advances in technology further complicate the delineation of patent boundaries. Courts have long sought to balance the incentive and notice purposes of the patent law. Requirements of clear and definite claiming further the notice goal but complicate other areas of patent law—such as determining the standards for nonliteral infringement where the “doctrine of equivalents” serves as a fulcrum of the incentives/notice balance.

Applying these principles in a complex patent dispute can be a challenging task. This guide seeks to rationalize and systematize the process of managing patent cases. Although many aspects of the patent statute are technical, patent adjudication involves many doctrines that demand the exercise of discretion. These larger purposes of the patent system provide the touchstone for interpreting the Patent Act and applying many patent doctrines.

1.1.2 Evolution of the Patent System

The nation's first patent act, enacted during the first congressional session, set forth terse general standards for protection, duration, rights, and remedies, but few details. This original institutional structure of the U.S. patent system was, however, short-lived for several reasons. It called upon the Secretary of State (Thomas Jefferson), the Secretary for the Department of War, and the Attorney General to examine patents, which, in light of their other responsibilities, proved untenable. Second, inventors were displeased with the high and vague threshold for protection: that inventions be deemed “sufficiently useful and important.”

As a result, in 1793, Congress struck the requirement that inventions be “sufficiently useful and important” and replaced the examination process with a registration system, leaving the evaluation of patentability entirely to the courts. The Patent Act of 1793 retained a terse standard for patentability: an inventor could patent “any new and useful art, machine, manufacture or composition of matter, or any new and useful improvement on any art, machine, manufacture or composition of matter, not known or used before the application.” Patent Act of Feb. 21, 1793, ch. 11, § 1, 1 Stat. 318. The inventor was still required to provide a written description of the invention and the manner of use “in such full, clear and exact terms, as to distinguish the same from all other things before known, and to enable any person skilled in the art or science, of which it is a branch, or with which it is most nearly connected, to make, compound, and use the same.” *See id.*, § 3.

The courts fleshed out this lean statute. In the early years, they filled its gaps with English case law. *See generally* Peter S. Menell, *The Mixed Heritage of Federal Intellectual Property Law and Ramifications for Statutory Interpretation*, in *Intellectual*

Property and the Common Law 70–71 (Shyam Balganesch ed., 2013). In 1818, Justice Story, who wrote forty patent law opinions between 1813 and 1845, issued a paper stating that “[t]he patent acts of the United States are, in a great degree, founded on the principles and usages which have grown out of the English statute on the same subject.” See *On the Patent Laws*, 16 U.S. (3 Wheat.) App. 13-29 (1818) (quoted in Edward C. Walterscheid, *To Promote the Progress of Useful Arts: American Patent Law and Administration, 1787–1836 (Part 1)*, 79 J. Pat. & Trademark Off. Soc’y 61 (1997)); see also Frank D. Prager, *The Influence of Mr. Justice Story on American Patent Law*, 5 Am. J. of Leg. History 254 n.1 (1961). In his first patent law opinion, Justice Story, sitting as a circuit justice, distinguished between unpatentable elements of motion and “the modus operandi, the peculiar device or manner of producing any given effect.” The opinion recognized an experimental use defense based on the inference that “it could never have been the intention of the legislature to punish a man, who constructed such a machine merely for philosophical experiments, or for the purpose of ascertaining the sufficiency of the machine to produce its described effects.” See *Whittemore v. Cutter*, 29 F. Cas. 1120, 1121–24 (C.C. Mass. 1813). In 1817, he expanded on the meaning of “useful invention” and novelty. See *Bedford v. Hunt*, 3 F. Cas. 37, 37–39 No. 1217 (C.C.D. Mass. 1817). In 1829, Justice Story interpreted the novelty requirement of “not known or used before the application” to pertain only to knowledge or use “by the public.” See *Pennock v. Dialogue*, 27 U.S. 1, 19 (1829).

The courts also established standards for disclosure, requiring that the patent document identify the patented invention with specificity and distinguish it from the prior art. See *Lowell v. Lewis*, 15 F. Cas. 1018, No. 8568 (C.C.D. Mass. 1817); *Evans v. Eaton*, 20 U.S. 356, 434–35 (1822). In the absence of an ex-ante examination system, the patent bar developed the patent claim to reduce the risk of an invalidity ruling and to establish infringement more easily. See J. Jonas Anderson & Peter S. Menell, *Informal Deference: A Historical, Empirical, and Normative Analysis of Patent Claim Construction*, 108 Nw. U. L. Rev. 1, 8–21 (2014) (tracing the history of patent claiming).

Nonetheless, the lack of an examination system eroded faith in the patent system due to the proliferation of “unrestrained and promiscuous grants of patent privileges.” See John Ruggles, Select Committee Report on the State and Condition of the Patent Office, S. Doc. No. 24-338, at 4 (1836). The Senate Report Accompanying the Patent Act of 1836 lamented that “[a] considerable portion of all the patents granted are worthless and void, as conflicting with, and infringing upon one another,” the country had become “flooded with patent monopolies, embarrassing to bona fide patentees, whose rights are thus invaded on all sides,” and that the “interference and collision of patents and privileges” had produced ruinous vexatious litigation. See Senate Report Accompanying Senate Bill No. 239, 24th Cong., 1st Sess. (Apr. 28, 1836).¹ In response, the Patent Act of 1836 instituted examination in a newly consti-

1. Analogous complaints have been made during the past two decades in reaction to the proliferation of business method and software patents. See Dan L. Burk & Mark A. Lemley,

tuted Patent Office, codified claiming conventions that grew out of jurisprudence, and introduced other procedural and institutional reforms, but perpetuated the standards of the 1793 Act as interpreted by the courts. *See* Patent Act of July 4, 1836, ch. 357, 5 Stat. 117.

In the century following the 1836 Act, the Supreme Court and lower federal courts established and explicated many of the key patent law doctrines: non-obviousness (*Hotchkiss v. Greenwood*, 52 U.S. 248 (1850)), limitations on patentable subject matter (*Le Roy v. Tatham*, 55 U.S. (14 How.) 156 (1853); *O'Reilly v. Morse*, 56 U.S. 62 (1853)), written description (*O'Reilly v. Morse*, 56 U.S. 62 (1853)), the doctrine of equivalents (*Winans v. Denmead*, 56 U.S. 330 (1854)), the doctrine of abandonment, suppression, or concealment as a limitation on prior art (*Kendall v. Winsor*, 62 U.S. 322, 328 (1858)), the best mode requirement (*Magic Ruffle Co. v. Douglas*, 16 F. Cas. 394, 396–97, No. 8948 (C.C.S.D. N.Y. 1863)), contributory infringement (*Wallace v. Holmes*, 29 F. Cas. 74 (No. 17,100) (C.C. Conn. 1871); *Thomson-Houston Elec. Co. v. Ohio Brass Co.*, 80 F. 712 (6th Cir. 1897)), experimental use exception to the statutory bar (*Elizabeth v. Pavement Co.*, 97 U.S. 126 (1877)), and accidental anticipation doctrine (*Tilghman v. Proctor*, 102 U.S. 707 (1880)).

As the patent system changed the dynamics of competition, concerns about economic concentration grew, contributing to the development of antitrust law. *See* Sherman Act, July 2, 1890, ch. 647, 26 Stat. 209. Courts became more skeptical of patent protection. Toward the end of the nineteenth century, the courts seemed “to become keenly aware that a patent could be used to stifle competition [and] they became stingy with preliminary injunctions against infringement.” *See* Lawrence M. Friedman, *A History of American Law* 380 (1973). In 1883, Justice Bradley observed that, although inventors of substantial discoveries “are worthy of all favor,”

[i]t was never the object of those laws to grant a monopoly for every trifling device, every shadow of a shade of an idea, which would naturally and spontaneously occur to any skilled mechanic or operator in the ordinary progress of manufactures. Such an indiscriminate creation of exclusive privileges tends rather to obstruct than to stimulate invention. It creates a class of speculative schemers who make it their business to watch the advancing wave of improvement, and gather its foam in the form of patented monopolies, which enable them to lay a heavy tax upon the industry of the country, without contributing anything to the real advancement of the art. It embarrasses the honest pursuit of business with fears and apprehensions of concealed liens and unknown liabilities to lawsuits and vexatious accountings for profits made in good faith.

Atl. Works v. Brady, 107 U.S. (17 Otto) 192, 200 (1883). These concerns contributed to judicial development of the exhaustion doctrine (*Adams v. Burke*, 84 U.S. 453 (1873)), the enablement doctrine (*The Incandescent Lamp Patent*, 159 U.S. 465 (1895)), the patent-misuse doctrine (*Motion Picture Patents Co. v. Universal Film*

The Patent Crisis and How the Courts Can Solve It (2009); James Bessen & Michael J. Meurer, *Patent Failure: How Judges, Bureaucrats and Lawyers Put Innovation at Risk* (2008); Adam B. Jaffe & Josh Lerner, *Innovation and Its Discontents* (2004).

Mfg. Co., 243 U.S. 502 (1917)), the reverse doctrine of equivalents (*Westinghouse v. Boyden Power Brake Co.*, 170 U.S. 537 (1898)), laches (*Woodbridge v. United States*, 263 U.S. 50 (1923); *Webster Elec. Co. v. Splitdorf Elec. Co.*, 264 U.S. 463 (1924)), and the inequitable-conduct defense (*Keystone Driller Co. v. General Excavator Co.*, 290 U.S. 240 (1933); *Hazel-Atlas Glass Co. v. Hartford-Empire Co.*, 322 U.S. 238 (1944); *Precision Instrument Mfg. Co. v. Automotive Maint. Mach. Co.*, 324 U.S. 806 (1945)).

1.1.2.1 Patent Act of 1952

Modern patent law dates to 1952, *see* Patent Act of 1952, Pub. L. No. 82-593, ch. 950, 82d Cong., 2d Sess., 66 Stat. 792, when Congress codified patent law in Title 35 of the U.S. Code and responded to pressure to correct court decisions from the prior two decades substantially raising the inventiveness bar. *See* P.J. Federico, *Origins of Section 103*, 5 APLA Q.J. 87 (1977). The House report characterized codification as the “principal purpose” of the bill. *See* H.R. Rep. No. 82-1923, at 5 (1952). One leading treatise observes that “[v]ery ancient statutory language was thus carried over, in a conscious effort to preserve existing statutory interpretations.” Carl Moy, *Moy’s Walker on Patents* § 1:23 (4th ed. 2010).

Much of the 1952 Act restated provisions from prior law while integrating, codifying, and in a few instances altering judicial doctrines. The 1952 Act retained the 1793 Act’s text governing patentable subject matter virtually verbatim. The only pertinent difference between the 1793 and 1952 provisions is the substitution of the word “process” for “art.” This alteration was not intended to effect any substantive change or to supplant more than a century of jurisprudence interpreting “art.” *See* Peter S. Menell, *Forty Years of Wondering in the Wilderness and No Closer to the Promised Land: Bilski’s Superficial Textualism and the Missed Opportunity to Return Patent Law to its Technology Mooring*, 63 *Stan. L. Rev.* 1289, 1296–97 (2011). Rather, it was to avoid confusion with other meanings of the word “art.”

The House report noted two “major” changes to the substantive patent law: “incorporating a requirement for invention in § 103 and the judicial doctrine of contributory infringement in § 271.” *See* H.R. Rep. No. 82-1923, at 5 (1952). During the 1930s and 40s, the Supreme Court substantially tightened the judicially developed nonobviousness standard to require a “flash of genius.” *See Cuno Eng’g Corp. v. Automatic Devices Corp.*, 314 U.S. 84, 91 (1941); *see also Great Atl. & Pac. Tea Co. v. Supermarket Equip. Corp.*, 340 U.S. 147, 152 (1950). In response, Congress formally codified the nonobviousness requirement. “[T]he manner in which the invention was made,” whether “from long toil and experimentation or from a flash of genius” is immaterial to its patentability. It lowered the bar to what courts before 1930 had previously recognized as the appropriate level. *See* § 103; H.R. Rep. No. 82-1923, at 7, 18 (1952).

Congress also codified judicially developed, indirect liability doctrines, although with some adjustment to partially blunt recent expansion in the judicially developed patent misuse doctrine. The legislative history notes that “[t]he doctrine of contributory infringement has been part of our law for about 80 years,” but that “[c]onsiderable doubt and confusion as to [its] scope” has resulted from recent pa-

tent misuse cases. See H.R. Rep. No. 82-1923, at 9 (1952) (referring principally to *Mercoird Corp. v. Mid-Continent Inv. Co.*, 320 U.S. 661 (1944)). In response, Congress expressly recognized the contributory infringement cause of action while codifying an express exclusion for the sale of staple articles of commerce suitable for noninfringing use. See *id.*; § 271(c). The 1952 Act also expressly authorized the use of means-plus-function claims, although with limitations on their scope. See § 112, ¶ 3, 66 Stat. at 798 (now codified at § 112(f)) (overturning *Halliburton Oil Well Cementing Co. v. Walker*, 329 U.S. 1, 12 (1946), which barred functional claiming).

Although the Patent Act of 1952 simplified and fleshed out the patent law, it left many important doctrines free-floating in jurisprudence. Even after this codification, the formal patent law still contained no mention of limitations on patent eligibility (or patentable subject matter), the experimental use exception to the statutory bar, the accidental anticipation doctrine, the doctrine of equivalents, the reverse doctrine of equivalents, the experimental use defense, the exhaustion doctrine, the patent misuse doctrine, the inequitable conduct doctrine, laches, or equitable estoppel.

1.1.2.2 America Invents Act of 2011

The vast expansion of patenting in the 1990s generated significant concerns about patent quality, anticompetitive patent thickets, and so-called patent “trolls”—nonpracticing entities principally in the information technology fields that pursued patent-assertion strategies against start-up and established technology companies. In addition, Congress heard calls for addressing the large and growing backlog of patent applications and promoting international harmonization. Comprehensive studies by the Federal Trade Commission (FTC) and the National Academies of Sciences (NAS) recommended comprehensive reforms—from tightening the nonobviousness standard to raising the bar for obtaining injunctive relief, clarifying (and tightening) the willfulness standard, rationalizing the determination of patent damages, shifting to a first-to-file system, and better funding Patent Office operations. See *A Patent System for the 21st Century* (Stephen A. Merrill, Richard C. Levin & Mark B. Myers eds., 2004); Fed. Trade Comm’n, *To Promote Innovation: The Proper Balance of Competition and Patent Law and Policy* (2003).

Beginning in 2005, Congress took up these and other recommendations, such as expanding postgrant review and moving to a first-to-file system, but it struggled to find common ground amidst the cacophony of competing interest groups. One of the greatest challenges faced by policymakers is making laws and rules that are fair both in the context of industries where the commercial products involve a single patent or a very small number of patents (e.g., pharmaceuticals, agriculture, chemicals) and in the context of industries where a large number of patents are involved in a single commercial product (e.g., mobile devices, semiconductors, software).

As Congress struggled to find common ground and to balance divergent industry concerns, the Supreme Court and the Federal Circuit have addressed much of the reform agenda through statutory interpretation and crafting of judicially created doctrines. The Supreme Court tightened the standard for obtaining injunctive relief, see *eBay Inc. v. MercExchange, LLC*, 547 U.S. 388 (2006), and the nonobviousness

requirement, *see KSR Int'l Co. v. Teleflex Inc.*, 550 U.S. 398 (2007). The Federal Circuit has raised the bars for proving reasonable royalty. *See Uniloc USA, Inc. v. Microsoft Corp.*, 632 F.3d 1292 (Fed. Cir. 2011); *Lucent Techs., Inc. v. Gateway, Inc.*, 580 F.3d 1301 (Fed. Cir. 2009).

Only after the courts had resolved the most controversial issues dividing interest groups was there sufficient consensus for Congress to pass the America Invents Act in September 2011, *see* Pub. L. No. 112-29, 125 Stat. 284, a far less ambitious set of substantive patent reforms than those originally recommended and reflected in earlier patent reform packages. Although touted as the most significant change in patent legislation since the 1952 Act, the AIA did not ultimately address many of the concerns voiced in the FTC and NAS reports. The AIA principally addressed administrative changes to the patent system: shifting to a modified first-to-file system (retaining a grace period for inventor disclosure) and implementing a postgrant review process. The former change largely harmonized U.S. novelty provisions with those in place in most other patent systems around the world, while retaining a one-year grace period for inventor publication. The latter change reorganized the Board of Patent Appeals and Interferences (BPAI) into the Patent Trial and Appeal Board (PTAB) and established several new administrative postgrant review proceedings—postgrant review, covered business method review (CBMR), *inter partes* review (IPR), and derivation proceedings—offering those challenging patents a streamlined, participatory, and relatively rapid means for obtaining review of issued patents by panels of three administrative patent judges. In contrast to the often slow *inter partes* reexamination process, IPRs must be completed within eighteen months of the filing of a petition.²

The AIA has dramatically altered the patent litigation landscape, although not in ways that were fully anticipated at the time of its enactment. In its first full year of operation, the PTAB received over 1,000 petitions. The PTAB instituted review in over 80% of these petitions, and invalidated many of the reviewed claims. *See* Brian J. Love & Shawn Ambwani, *Inter Partes Review: An Early Look at the Numbers*, 81 Univ. of Chi. L. Rev. Dialogue 93 (2014) (reporting that the PTAB invalidated all claims in 77.5% of the first 160 petitions instituted). In light of these statistics, many accused patent infringers have predictably pursued IPRs upon being sued in district court, leading to many requests to stay district court proceedings pending PTAB re-

2. The AIA also expanded the prior user right for “method[s] of doing or conducting business” to all inventive fields, although the standards for establishing the right are high. *See* § 273 (the defendant must show by “clear and convincing evidence” that it commercially used the technology at least one year prior to the earlier of the effective filing date of the claimed invention or the date on which the claimed invention was disclosed to the public in a manner that qualified for the § 102(b) grace period). Congress added this defense in response to the Federal Circuit’s 1998 decision rejecting the long-standing business method exception to statutory subject matter. *See State St. Bank & Tr. Co. v. Signature Fin. Grp., Inc.*, 149 F.3d 1368, 1375 (Fed. Cir. 1998); First Inventor Defense Act of 1999, Pub. L. No. 106-113, 113 Stat. 1536 (1999).

view. Although the institution and invalidation rates have dropped since the first year of the PTAB's operation, they remain substantial.

The White House and the U.S. Patent and Trademark Office (USPTO) have also played a significant role in addressing perceived problems with the patent system through administrative action. The USPTO has, for example, implemented the Prioritized Examination Program, issued § 112 guidance documents, and pursued patent quality initiatives aimed at improving claim clarity.

1.1.2.3 Deciphering and Interpreting Patent Law

Throughout the nineteenth century and into the twentieth century, courts fleshed out the skeletal early patent statute. They patched statutory gaps, integrated constitutional, antitrust, and pragmatic limitations, and drew on tort and equity principles to effectuate the enforcement of rights. Reflecting the jurisprudential style of those eras and the influence of their common-law roots, character, and responsibilities, the most influential intellectual property jurists—including Justice Joseph Story, Justice Benjamin Robbins Curtis, and later Judge Learned Hand—operated in a less formal, more common-law-oriented mode. *See* William C. Robinson, *The Law of Patents for Useful Inventions* 15, n.3 (1890) (“Our patent acts have always depended upon common-law principles for their construction and until recently have been uniformly treated as a part of that great body of theoretical and practical jurisprudence. Patent law is as truly though not so extensively a matter of historical development as the law of real property, and can no more be beneficially administered as a mere statutory system inoperative except where verbally declared, than any other of those ancient branches of the law which we have inherited from our Anglo-Saxon ancestors.”). Their objective was to bring logic, consistency, and balance to the patent and copyright systems. As a consequence, they did not typically tie their interpretation tightly to statutory text. Through a pragmatic process drawing upon statutory, constitutional, and experiential sources as well as common sense, they forged patent law into a workable, dynamic system.

These patterns persist in the contemporary patent system as courts continue to play a critical role in evolving the patent system. The most significant changes to U.S. patent law in response to the calls for patent reform during the past decade took place in the courts—through tightening of the nonobviousness standard, raising the threshold for equitable relief, and reining in reasonable royalty determinations. More generally, the courts have made subtle adjustments to better accommodate differences among the broad range of technologies governed by a unitary patent system.

Courts will continue to play a substantial and critical role in developing patent law. Key features of patent law emerged as terse formulations during the early republic and have evolved through symbiotic processes of judicial, common-law-type development and legislative codification, correction, and addition. The rapidity and unpredictability of technological change have buffeted courts with new challenges, and they have employed common-law tools and functional reasoning to evolve the intellectual property system. This institutional mechanism, in the face of Congress's

limited ability to act expeditiously and lack of sustained focus, has enhanced the courts' substantive imprint on patent law. The courts are currently struggling with the scope of patentable subject matter, a critical issue for the patent system and patent case management on which Congress has notably been silent.

The mixed heritage of patent law has important ramifications for statutory interpretation. To effectuate patent law's purposes, courts should be mindful of the source of the doctrines in play—whether common law or statutory. *See Menell, The Mixed Heritage of Federal Intellectual Property Law and Ramifications for Statutory Interpretation*, at 87–88. In assessing the provenance of statutory provisions, courts should remain open to examining legislative history—especially with regard to codification statutes and other amendments intended to explain the nature and purpose of judicially developed and crafted doctrines.

1.1.3 Patent Institutions

The district courts play a vital role in both enforcing patents and reviewing the validity of patent grants. This role should be understood within the larger patent system, which comprises the USPTO, the Court of Appeals for the Federal Circuit, and the International Trade Commission. In addition to these government institutions, there is a growing private marketplace for patent assets, which increasingly affects litigation.

1.1.3.1 The Patent Office

The Patent Office originates in the Patent Act of 1836 which reinstated patent examination and established a formal agency. The Patent Office developed procedures for patent examination. Funding came principally from examination fees. Congress added trademark registration to the agency's responsibilities in 1881.

The USPTO today is an agency of the U.S. Department of Commerce. Nonetheless, federal law affords the USPTO greater independence over its operations and finances than most other subcabinet agencies.

The United States Patent and Trademark Office is established as an agency of the United States, within the Department of Commerce. In carrying out its functions, the United States Patent and Trademark Office shall be subject to the policy direction of the Secretary of Commerce, but otherwise shall retain responsibility for decisions regarding the management and administration of its operations and shall exercise independent control of its budget allocations and expenditures, personnel decisions and processes, procurements, and other administrative and management functions in accordance with this title and applicable provisions of law. Those operations designed to grant and issue patents and those operations which are designed to facilitate the registration of trademarks shall be treated as separate operating units within the Office.

35 U.S.C. § 1(a). The Department of Commerce retains principal authority over policy matters, such as legislative positions, regulatory actions, and positions taken in interagency discussions relating to court cases. These decision processes are gov-

erned by a complex set of agreements and precedents between the Department of Commerce, the USPTO, and the Office of Management and Budget.

The USPTO is headquartered in Alexandria, Virginia. It is in the process of establishing satellite offices in four locations: Dallas, Texas; Denver, Colorado; Detroit, Michigan; and San Jose, California.

The Patent Office's primary function remains patent examination. It employs 12,000 people, including approximately 9,000 patent examiners and over 200 administrative patent judges (APJs). Examiners and APJs have technical backgrounds. Examiners are assigned to "art units" within "technology centers" based on their educational background and experience. They do not typically have law degrees but receive training in the requirements for patentability and patent prosecution.

Inventors filed over 578,000 utility patent applications in 2014, up from 164,558 utility patent applications in 1990. The USPTO granted over 300,000 in 2014, up from approximately 90,000 in 1990. The USPTO also received over 35,000 design patent applications and 1,000 plant patent applications in 2014, up from 11,288 and 418 respectively in 1990.

Section 14.2 provides general background about patent prosecution. The average pendency time for a utility patent application is approximately three years from the time of filing, although the time can vary significantly across technology fields. The USPTO is working to reduce a backlog of over one million patent applications.

Upon final rejection of a patent application, the applicant can seek continuing examination or appeal by the Patent Trial and Appeal Board (PTAB). See § 14.2.1.3. In addition, the PTAB conducts several new administrative review proceedings discussed in §§ 1.1.2.2, 14.2.1.3, 14.2.5.8.

Under § 282 of the Patent Act, issued patents enjoy a presumption of validity. Thus, the alleged infringer in a patent enforcement action (or a declaratory relief plaintiff) bears the burden of proving invalidity by clear and convincing evidence. See *Microsoft Corp. v. i4i Ltd. P'ship*, 131 S. Ct. 2238 (2011); § 14.2.6.

1.1.3.2 The Court of Appeals for the Federal Circuit

The Court of Appeals for the Federal Circuit, sitting in Washington, D.C., has exclusive jurisdiction over appeals of patent rejections from the USPTO as well as all appeals of patent decisions by the U.S. district courts and the U.S. International Trade Commission. In the former capacity, the Federal Circuit inherited the responsibilities of the U.S. Court of Customs and Patent Appeals.

Congress established the Federal Circuit in 1982 to provide greater doctrinal consistency and stability by creating a unified, specialized appellate court. See Rochelle Dreyfuss, *The Federal Circuit: A Case Study in Specialized Courts*, 64 N.Y.U. L. Rev. 1 (1989). Prior to its creation, there was substantial variation among the circuit courts of appeal in their attitudes toward patentability and enforcement. This new institution has significantly increased the rate at which patents have been upheld and has generally expanded patent protection. See William M. Landes & Richard A. Posner, *An Empirical Analysis of the Patent Court*, 71 U. Chi. L. Rev. 111, 112 (2004). It

has also greatly increased the velocity of patent jurisprudence, speeding the responsiveness of all institutions governing patent protection to perceived problems.

The Federal Circuit's activity and internal divisions, as well as the greater salience of the patent system, have often captured the Supreme Court's attention over the past fifteen years. Whereas patent cases hovered between 1 and 2% of the Supreme Court's docket during the latter half of the twentieth century, the rate jumped to 3% in the 2000–2010 period. Since 2010, it has risen to over 5%, approaching the highest levels in U.S. history.³ In addition, Congress and the USPTO have become far more active in adapting the patent system during the past decade.

1.1.3.3 The International Trade Commission

In 1974, Congress expanded the authority of the ITC to exclude unfair imports to the United States. *See* 19 U.S.C. § 1337; § 14.6.2.1. During the past decade, the ITC has emerged as one of the most salient patent enforcement venues in the United States. Its fast-track procedures—typically producing determinations within sixteen months of initiation of an investigation—and potent exclusion remedy have attracted an increasing number of patentees. *See Spansion, Inc. v. Int'l Trade Comm'n*, 629 F.3d 1331, 1358–59 (Fed. Cir. 2010) (interpreting the legislative framework governing the ITC as making injunctive relief “the normal remedy for a Section 337 violation” without a showing of irreparable harm).

The ITC now conducts more full patent adjudications on an annual basis than any individual district court in the nation. Since 2010, the ITC has instituted approximately 50 patent investigations per year, of which about 45% settle prior to a decision. *See* U.S. International Trade Commission, USITC Section 337 Investigations—Facts and Trends Regarding Caseload and Parties (June 2014 Update), *available at* http://www.usitc.gov/press_room/documents/featured_news/337facts2014.pdf. Its Section 337 administrative law judges (ALJs) focus almost exclusively on patent investigations, making the ITC the nation's only specialized, trial-level, patent-adjudication forum.

1.1.3.4 The Marketplace for Patents and Patent Litigation

The past two decades have witnessed the emergence of robust markets for patents and patent dispute resolution. Following the burst of the dot-com information-technology bubble in the late 1990s, a raft of information technology patents came onto the open market through bankruptcy and other transactions. This fueled what has come to be known as the “patent troll” problem—the assertion of often-vague patents by nonpracticing entities. Start-up companies can be particularly vulnerable because they do not have the time to litigate or seek reexamination of dubious patents during the precarious early business development phase. As the litigation over smartphones heated up, major technology companies spent billions of dollars to arm

3. During the industrial revolution—from 1840 through 1900—patent cases constituted between 3% to 8% of the Supreme Court's docket.

themselves with defensive and offensive patent portfolios. This arms race has spurred patent acquisition strategies that strain the resources of the USPTO and ultimately fuel patent litigation.

These factors have produced a complex strategic matrix for technology companies and patent litigators. Patent strategy has become integrated with business and litigation strategy in many technology markets. In the lead-up to initial public offerings, start-ups must navigate a bewildering maze of patent claims. They are under great pressure to settle disputes. District courts increasingly find themselves at the center of multifront battles over the hottest technologies.

It is important for district judges to recognize that the litigation in their courtrooms can be but one front in a complex, competitive war. The parties typically weigh a host of strategic options: inter partes or covered business method review at the PTAB; an ITC investigation; declaratory relief; alternative dispute resolution; and relief from foreign tribunals. Understanding this larger battleground is critical to managing the litigation in their courtroom.

1.2 A Preliminary Note About Settlement of Patent Cases

Patent litigation is expensive. Each side can expect to spend several million dollars in fees through trial in the simplest, single-patent case. Litigation costs quickly spiral in more complex patent cases. The high cost reflects in part the high stakes involved. For most businesses, this potential risk, coupled with the unpredictability of juries deciding complex technical questions, means that exploring settlement should be an imperative. Indeed, like other litigation, the vast majority of patent cases (more than 95%) ultimately resolve before trial—most through settlement and just under 10% through summary judgment rulings. But the timing of settlement varies widely. Approximately 30% of patent cases resolve before any court actions; approximately half resolve early in case management; and approximately 15% during or after pretrial proceedings. See FTI Consulting, *Intellectual Property Statistics* (May 2008) (based on data gathered by the Administrative Office of the U.S. Courts). Table 1.1 shows the median cost of resolving patent cases through the end of discovery and trial.

Table 1.1
Median Patent Litigation Costs: 2013

Amount in Controversy	Through End of Discovery	Through End of Trial
Less than \$1 million	\$530,000	\$970,000
\$1 million to \$25 million	\$1,700,000	\$2,800,000
Over \$25 million	\$3,600,000	\$5,900,000

Source: American Intellectual Property Law Association, *Report of Economic Survey* (2013).

Thus, early resolution offers substantial savings to the parties and the court in terms of resources and time. What are the impediments to earlier resolution, and what part can the district judge play to encourage it? Although we address this issue in detail in § 2.6, it is worthwhile highlighting key considerations for the outset of patent litigation.

The first barrier to settlement may be the relationship of the parties. For example, if the patent holder is not an operating entity but only holds its patents for assertion against potential infringers, it risks only the patents-in-suit and the cost of the litigation and faces no possibility of field-leveling counterclaims. For the defendant company accustomed to resolving disputes with competitors through compromise, this asymmetrical situation can lead to standoff. Just as challenging for different reasons is the case involving head-to-head competitors for whom litigation may be an important element in their competitive strategies.

The most effective approaches to settlement, therefore, require judicial intervention, early and often. This typically begins at the first case-management conference, where the court can relieve counsel (or one of them) of their natural reluctance to address the issue. The court should make it clear that cooperation and frequent reports on settlement are just as important as other aspects of case management. The type of process (e.g., early neutral evaluation, outside mediation, magistrate judge conference) and date for completion of the first phase should be set at this stage. The court should express its willingness to order in-person attendance by appropriate executives. To the objection that discovery will have to come first, the court should make clear that any information reasonably necessary to assess each side's position should be exchanged promptly. To the objection that settlement cannot usefully proceed until the court has construed the asserted claims, the court should point out that uncertainty often drives settlement, and early discussions will likely hasten the settlement process.

The best time for settlement is often at the outset of litigation, before vast amounts of time and resources are expended and positions harden. Apart from that, mediation can be most effective (a) after some initial discovery (when each side has presumably learned more about the merits), (b) just after a pivotal event, such as a claim-construction order, or a ruling on a preliminary injunction request or on summary judgment motions, or (c) just before such a high-risk, pretrial event, or just before trial itself (keeping in mind Samuel Johnson's oft-quoted observation that "when a man knows he is to be hanged in a fortnight, it concentrates his mind wonderfully").

Table 2.7 provides a practical guide for managing the underlying dynamics and pertinent settlement issues in the most common types of patent disputes:

- competitor versus competitor (regarding core technology)
- competitor versus competitor (noncore technology)
- large enterprise versus start-up/new entrant
- licensing company versus large enterprise
- licensing company versus start-up enterprise
- pharmaceutical versus pharmaceutical

Chapter 1: General Principles for Effective Patent Case Management

- patent owner versus first alleged infringer (serial litigant)
- pharmaceutical versus generic
- medical device industry
- preliminary injunction motion

Here is a summary of general ways a district court can effectively encourage settlement of patent litigation:

1. Make clear to counsel that settlement is a process, not an event, and that it is extremely important to the court.
2. Get the settlement process moving early, dealing with objections that might cause delay. Appoint a mediator with experience in resolving patent disputes (this does not necessarily mean a patent lawyer).
3. Require frequent reports on the status of settlement efforts, requiring multiple mediation sessions if necessary.

Chapter 2

Early Case Management

- 2.1 Patent Litigation Timelines and Specialized Local Rules 4
 - 2.1.1 Case Assignment—Patent Pilot Program 4
 - 2.1.2 Protective Orders 5
 - 2.1.2.1 Default Protective Orders 6
 - 2.1.2.1.1 Timing 7
 - 2.1.2.1.2 Substance—Tier Structure 7
 - 2.1.2.1.3 Prosecution Bars 9
 - 2.1.3 Managing Claim Winnowing and Construction of Claim Terms 9
 - 2.1.3.1 Patent and Claim Winnowing 11
 - 2.1.3.2 Claim Construction 13
 - 2.1.3.2.1 Winnowing Claim Terms 18
 - 2.1.3.2.2 Claim-Construction Briefing and Oral Argument 18
 - 2.1.3.2.3 Claim Construction and Discovery 21
 - 2.1.3.2.3.1 Discovery Prior to Claim Construction 21
 - 2.1.3.2.3.2 Fact Discovery After Claim Construction 22
 - 2.1.3.2.3.3 Expert Discovery After Claim Construction 22
 - 2.1.3.2.3.4 Legal Contentions After Claim Construction 23
 - 2.1.3.2.4 Claim Construction Generally Should Precede, but May Be Combined with, Summary Judgment 23
 - 2.1.3.2.5 Claim Construction May Encourage Settlement 24
 - 2.1.3.2.6 Preliminary Injunction Motions Usually Require Preliminary Claim Construction 25
 - 2.1.4 Managing the Parties’ Claims, Defenses, Prior Art References, and Counterclaims 26
 - 2.1.4.1 Early Document Production 26
 - 2.1.4.2 Ownership and Standing 26
 - 2.1.4.3 Joint Infringement 26
 - 2.1.4.4 Winnowing Prior Art References 27
 - 2.1.4.5 Other Practices 27
- 2.2 Complaint and Answer 28
 - 2.2.1 Plaintiff Standing Requirements 29
 - 2.2.1.1 Infringement Plaintiff 29
 - 2.2.1.1.1 Infringement Plaintiff Must Hold All Substantial Patent Rights 29
 - 2.2.1.1.2 Plaintiff Must Join All Joint Patent Owners 29
 - 2.2.1.1.3 An Exclusive Licensee Must Sometimes Join Its Licensor 30
 - 2.2.1.1.4 A Nonexclusive Licensee Has No Standing to Sue 31
 - 2.2.1.1.5 Patentee Can Only Convey Right to Sue by Transferring Substantially All Patent Rights 31
 - 2.2.1.1.6 A Covenant Not to Sue or Similarly Binding Representations Can Moot a Controversy Between the Parties 32
 - 2.2.1.1.7 Dismissal Based on Meritorious Standing Motions 32
 - 2.2.1.2 Declaratory Judgment Plaintiff 32
 - 2.2.1.2.1 Defendant’s Declaratory Judgment Counterclaims Are Not Mooted by Dismissal of Plaintiff’s Infringement Claims 34
 - 2.2.1.2.2 Assignor Is Estopped from Seeking Declaratory Judgment of Invalidity 35
 - 2.2.1.2.2.1 Parties in Privity with Assignor Are Also Estopped 35
 - 2.2.1.2.3 Actual Case or Controversy Can Exist for Licensee in Good Standing Even in Absence of Material Breach 36
 - 2.2.2 Defendant Standing Requirements 36
 - 2.2.2.1 Infringement Defendants 36
 - 2.2.2.1.1 Joinder Issues 37
 - 2.2.2.2 Declaratory Judgment Defendants 39

- 2.2.3 Pleading 39
 - 2.2.3.1 Infringement 39
 - 2.2.3.2 Willful Infringement 42
 - 2.2.3.2.1 Opinions of Counsel 42
 - 2.2.3.2.2 Privilege Issues Relating to Opinions of Counsel 43
 - 2.2.3.3 Defenses 44
 - 2.2.3.3.1 Invalidity Defenses 44
 - 2.2.3.3.2 Unenforceability Defenses 44
 - 2.2.3.3.2.1 Inequitable Conduct Pled with Particularity 44
 - 2.2.3.3.2.2 Privilege Issues Relating to Unenforceability 45
- 2.2.4 Counterclaims 45
 - 2.2.4.1 Compulsory Counterclaims 46
 - 2.2.4.2 Noncompulsory Counterclaims 46
- 2.2.5 Potential Overlap with Nonpatent Claims; Choice of Law 46
- 2.2.6 Interaction with Other Types of Actions 47
 - 2.2.6.1 Bankruptcy 47
 - 2.2.6.2 International Trade Commission Actions 47
 - 2.2.6.2.1 Stays Relating to Parallel ITC Proceedings 48
 - 2.2.6.2.2 Effect of ITC Rulings on District Court Proceedings 50
 - 2.2.6.3 Parallel District Court Proceedings 51
 - 2.2.6.4 PTO Review Proceedings—Reexamination, Reissue, and AIA Review 54
 - 2.2.6.4.1 Stays Pending Review or Reexamination 55
 - 2.2.6.4.2 Evaluating Stay Requests with Pending AIA Review 56
 - 2.2.6.4.3 Special Case: Stay Request with Pending CBMR 57
 - 2.2.6.5 Preemption of State-Law Unfair Competition Claims 58
- 2.2.7 Rule 11: Presuit Investigations—Objective Good Faith Basis for Filing Pleading 58
- 2.3 Jurisdiction and Venue 59
 - 2.3.1 Personal Jurisdiction 59
 - 2.3.2 Subject-Matter Jurisdiction 60
 - 2.3.2.1 Original Jurisdiction 60
 - 2.3.2.2 Supplemental Jurisdiction 60
 - 2.3.3 Venue 61
 - 2.3.3.1 Venue Transfer Motions 61
 - 2.3.4 Multidistrict Coordination 65
- 2.4 Scheduling 66
- 2.5 Case-Management Conference 66
- 2.6 Salient Early Case-Management Issues 71
 - 2.6.1 Multidefendant Litigations 71
 - 2.6.1.1 Multidefendant Litigations Based on Standards Compliance 72
 - 2.6.1.2 Customer/Manufacturer Multidefendant Litigations 72
 - 2.6.2 Spoliation 74
 - 2.6.3 Early Claim Construction 74
 - 2.6.4 Patentable Subject Matter 76
 - 2.6.5 Early Motions to Dismiss Indirect Infringement and Willfulness Claims 76
 - 2.6.6 Damages Theories and Proof 77
 - 2.6.7 Nuisance-Value Litigation 82
 - 2.6.8 “Proportional” Scope of Discovery 83
- 2.7 Settlement and Mediation 83
 - 2.7.1 Initiation of the Mediation Process 84
 - 2.7.2 Selection of the Mediator 84
 - 2.7.3 Scheduling the Mediation 85
 - 2.7.4 Powers of the Mediator and Who Should Be Present During Mediation 86
 - 2.7.5 Confidentiality of the Mediation 86
 - 2.7.6 Relationship of the Mediation to the Litigation Schedule 87
 - 2.7.7 Mediating Multiparty and Multijurisdictional Cases 88

2.7.8	Factors Affecting the Likelihood of Settlement of Particular Categories of Cases	88
Appendix 2.1	Initial Case-Management Conference Summary Checklist	93
Appendix 2.2a	Case-Management Checklist (Chief Judge Leonard Stark, District of Delaware)	97
Appendix 2.2b	Revised Procedures for Managing Patent Cases (Chief Judge Leonard Stark, District of Delaware) (June 18, 2014)	100
Appendix 2.2c	Revised Patent Form Scheduling Order (Chief Judge Leonard Stark, District of Delaware) (June 2014)	110
Appendix 2.3	Patent Pilot Program	119
Appendix 2.4	Protective Orders	123
Appendix 2.4a	Northern District of California, Patent Local Rule 2-2 Interim Model Protective Order	125
Appendix 2.4b	Northern District of California, Stipulated Protective Order for Litigation Involving Patents, Highly Sensitive Confidential Information, and/or Trade Secrets	142
Appendix 2.4c	Model Protective Order from the Northern District of Illinois	160
Appendix 2.4d	Stipulation for Protective Order from the District of Minnesota	165
Appendix 2.4e	Default Standard for Access to Source Code from the District of Delaware	170
Appendix 2.5a	Mediation Evaluation Form for Attorneys, Northern District of Illinois	171
Appendix 2.5b	Mediation Evaluation Form for Mediators, Northern District of Illinois	173
Appendix 2.5c	Mediation Evaluation Form for Parties, Northern District of Illinois	175

Without close management, patent cases can consume a vastly disproportionate amount of court and staff time. High stakes often result in extensive, contentious motion practice. Keys to success lie in the early establishment of a case schedule and procedures for streamlining resolution of common issues, as well as creative approaches to settlement. Discovery requires special attention; it is treated separately in Chapter 4. However, discovery challenges (anticipating and avoiding them) are connected with many of the pretrial issues confronted by district courts.

This chapter examines pretrial case management. We begin with a review of typical timelines and specialized local rules from jurisdictions that have found them useful in handling a large number of patent cases. For courts outside these districts, these approaches will be helpful in understanding the management choices available.

We then describe specific issues connected to pleadings, including jurisdiction and venue, standing, declaratory judgment, special patent defenses (such as inequitable conduct and assignor estoppel), and common associated claims such as anti-trust violations. The initial case-management conference (CMC) will be addressed, with particular attention to scheduling choices and their consequences. We consider the multipatent “mega case,” processes for identifying (and narrowing) infringement and invalidity contentions, and whether and how to schedule a *Markman* hearing to determine what the patent claims mean. We revisit the latter issues in detail in Chapter 5.

We cover some of the common early motions, such as a motion for stay pending review of the patent by the Patent Trial and Appeal Board (PTAB) at the U.S. Patent and Trademark Office (USPTO), motions to dismiss for subject-matter ineligibility (§ 101), and motions directed at managing the issue of willful infringement, which is frequently asserted and is a predicate for an award of enhanced damages and attorneys’ fees. We also discuss the critical process of encouraging resolution through mediation.

2.1 Patent Litigation Timelines and Specialized Local Rules

A patent case is, in many senses, like any other case. The plaintiff files a complaint alleging infringement. The defendant answers, alleging noninfringement and asserting various defenses, and potentially makes counterclaims of its own. The parties proceed to fact and expert discovery, motion practice, pretrial briefing, and trial. As in any litigation, the time necessary for each pretrial phase varies with the complexity and potential consequences of the issues presented.

However, there are certain unique aspects of patent litigation, the management of which will significantly affect the pretrial timeline. Key among these are the complexity of the legal issues, the complexity and difficulty of the technology at issue, and the large volume of highly sensitive technical documents, source code, and other information exchanged during discovery. Courts have implemented various mechanisms to help manage these and other issues efficiently and effectively, including the specialized case assignment rules in Patent Pilot Program districts, nearly universal use of protective orders, and patent local rules designed to facilitate discovery and frame claim construction.

2.1.1 Case Assignment—Patent Pilot Program

Concern over the challenges in handling patent cases led Congress to pass legislation in 2011 establishing the Patent Pilot Program. *See* Pub. L. 111-349 124 Stat. 3674, 28 U.S.C. § 137 (2011). The legislation established a ten-year project designed to enhance specialization and expertise in adjudicating patent cases and reduce the cost of patent litigation. Under the legislation, the Administrative Office of the United States Courts (AOUSC) designated fourteen district courts to participate. To be eligible, a district had to be among the fifteen district courts in which the largest number of patent and plant-variety protection cases were filed in 2010, or be district courts that adopted or certified to the director of the AOUSC the intention to adopt local rules for patent and plant-variety protection cases. From among the eligible courts that volunteered for the pilot program, the director was required by statute to select three district courts with at least ten authorized district judgeships in which at least three judges have made a request to hear patent cases, and three district courts with fewer than ten authorized district judgeships in which at least two judges have made a request to hear patent cases.

Under the legislation, patent cases filed in Patent Pilot Program districts are initially randomly assigned to all district judges, regardless of whether they have been designated to hear such cases. A judge who is randomly assigned a patent case but is not among the designated judges may decline to accept the case. That case is then randomly assigned to one of the district judges designated to hear patent cases. The Judicial Conference Committee on Court Administration and Case Management helps to implement the pilot program. The committee encourages the pilot courts in the project to use their case assignment system to ensure fairness in the distribution of the court's workload and to provide for the assignments of additional civil cases to

those judges who decline patent cases. Appendix 2.2 lists the districts participating in the Patent Pilot Program and the judges opting into the specialized pool.

In most districts, nondesignated judges have thirty days to reassign the case. The Western District of Pennsylvania and the Northern District of Texas give judges only seven days to decide whether to keep the case. *See* W.D. Penn. Misc. Order No. 11-283, ¶ 3; N.D. Tex. Special Order No. 3-287. The Southern District of California gives judges twenty-eight days to decide whether to keep the case. *See* S.D. Cal. General Order No. 598, ¶ 3. In the Northern District of California, judges must make a declination *before* the patent case would have been assigned. If the nondesignated judge declines the case, it is then randomly assigned to one of the designated patent judges.

The Northern District of California has adopted a general order to augment the assignment procedure for patent cases. In the Northern District, nonpatent judges are allowed to decline no more than three patent cases in any given year. *See* General Order No. 67, ¶ B(3). The Northern District has also taken the “position that the patent pilot statute does not supersede statutes that allow Magistrate Judges to handle any case pursuant to consent by the parties.” *See Patent Pilot Program Becomes Active January 1, 2012, available at* <http://www.cand.uscourts.gov/news/63>. Accordingly, the Northern District has designated magistrate judges who have an interest in patent cases. The Eastern District of New York has taken a similar position and also designated magistrate judges for the program. *See EDNY Implements Patent Pilot Program, available at* https://img.nyed.uscourts.gov/files/local_rules/PatentPilotProject-NYEDPressRelease.pdf.

The enabling legislation requires the FJC to study the extent to which the pilot program develops judicial expertise and efficiency in handling patent cases, the speed with which patent cases are resolved, reversal rates, and forum shopping. The pilot program also provides judges in non-pilot-program districts with readily identifiable resources (in the form of local rules, standing orders, and pilot-program judges themselves) and with substantial expertise on which to draw for guidance in managing patent cases.

Since its inception in 2011, only about one-third of patent cases originally assigned to nonpatent judges in district courts were reassigned to judges participating in the program. Thus, many judges within Patent Pilot districts that are not assigned to the program choose to retain their patent cases, but the patterns vary across districts. Owing to the relatively low referral rate, the Southern District of Florida discontinued its participation in the Patent Pilot Program in 2014.

2.1.2 Protective Orders

Patent litigation frequently presents situations where a party’s most important trade secret information is alleged to be relevant to the resolution of the case. This is true of both technical data, such as source code and records of product development, and business information, such as financial statements and underlying records of sales and profit calculation. In many cases, both parties’ sensitive information may be at issue.

As a result, the start of meaningful discovery in a patent case almost always requires the entry of a protective order—or, at a minimum, temporary provisions ensuring the confidentiality of discovery materials until a final protective order can be

entered. Protective orders prevent disclosure of highly sensitive technical, financial, licensing, or business strategy information both to the public and to the parties' competitive decision makers. Therefore, courts should require parties to address the propriety of an umbrella protective order at the initial case-management conference if the parties have not already taken up the issue on their own initiative (or pursuant to local rule). The complexity and sensitivity of information produced in discovery may result in a request for a multitiered protective order governing discovery, in which some information is available to the opposing party but restricted to use in the specific litigation ("confidential"), and other, more sensitive information is given only to counsel of record and approved experts ("highly confidential" or "attorneys only"). Such orders are fairly common, and although they can be said to interfere with counsel's ability to advise their clients effectively, this objection can be addressed in a more specific context when a party seeks permission to share particular information that had been designated attorneys-only. *See, e.g., Solaia Tech. LLC v. Jefferson Smurfit Corp.*, 2002 WL 1964761, 2002 U.S. Dist. LEXIS 15666, at *1–2 (N.D. Ill. Aug. 20, 2002).

The advantages of an umbrella protective order are that it reduces the number of times that the court is asked to resolve confidentiality issues, and it allows the information to be provided to opposing counsel in the first instance. Thus, when one side wants to change the designation of a particular document or set of data (for example, in order to prepare certain client representatives in advance of a settlement conference), the dispute can be informed by reference to actual documents, rather than abstractions.

The court should enter a protective order as soon as possible in the case. Often, key documents will not be produced until a protective order is entered to protect their confidentiality. The potential for opposition to entry of a protective order also weighs in favor of handling it at the outset of a case. In some litigation, the further the case develops, the harder it is for the parties to agree to confidentiality provisions. For example, in *Beech-Nut Nutrition Corp. v. Gerber Prods. Co.*, plaintiff Beech-Nut and defendant Gerber had jointly filed a stipulated protective order that the court rejected as overbroad. *See* No. CIV-S-01-1920-GEB-PAN, slip op. at 5 (E.D. Cal. Nov. 18, 2003). Beech-Nut opposed Gerber's subsequent motion for a protective order, despite originally agreeing to the stipulated protective order. *Beech-Nut*, No. CIV-S-01-1920-GEB-PAN (E.D. Cal. Mar. 16, 2004), slip op. at 1. However the terms of a protective order are determined, it is good practice to ensure that the protective order is in place before fact discovery begins in earnest.

2.1.2.1 Default Protective Orders

Many district courts implement default protective orders to avoid delays in patent litigation. Others provide default orders that give the parties advance guidance about the norms regarding protective order provisions for that district or judge, and provide judges with a neutral set of provisions that can be implemented in cases where the parties cannot agree on a joint protective order. Appendix 2.4 provides a catalog of default protective orders as well as a selection of default provisions. These approaches vary in terms of their timing and substance.

2.1.2.1.1 Timing

As noted, some districts have default protective orders that take effect automatically at the outset of the case. The Northern District of Illinois is one example. This district's approach recognizes that confidentiality issues abound in patent litigation. It prevents disputes or inaction regarding the protective order from delaying discovery, in particular, the exchange of patent-related contentions that the local rules require. After the default order is entered, the parties may, either at the outset of the case or later, seek a revised protective order that is more tailored to their case. Because the local rules provide for automatic entry of the default protective order, the desire to negotiate a more tailored version is not a basis to delay the disclosure and discovery schedule that the local rules contemplate. N.D. Ill. PLR 1.4. The Northern District of California takes a similar approach, requiring that “[d]iscovery cannot be withheld on the basis of confidentiality absent Court order. The Protective Order authorized by the Northern District of California shall govern discovery unless the Court enters a different protective order.” N.D. Cal. Patent L. R. 2-2.

Another approach is to require that, in the absence of a protective order, materials produced in discovery be treated as “outside attorneys’ eyes only” materials until a protective order is entered. *See, e.g.*, D. Del. LR 26.2 (“If any documents are deemed confidential by the producing party and the parties have not stipulated to a confidentiality agreement, until such an agreement is in effect, disclosure shall be limited to members and employees of the firm of trial counsel who have entered an appearance and, where appropriate, have been admitted *pro hac vice*. Such persons are under an obligation to keep such documents confidential and to use them only for purposes of litigating the case.”).

Some districts have prepared default protective orders but stop short of entering them automatically when a case is filed. For example, the District of Delaware has adopted a set of guidelines for the exchange of electronic discovery and a separate set of guidelines for the inspection of source code, which implicate many of the same issues as umbrella protective orders. *See* D. Del. Electronic Discovery Default Standard and Default Standard for Access to Source Code. Parties are thus free to craft their own case-specific orders, but can do so with a clear understanding of what is likely to be implemented if they cannot agree on joint provisions. The District of Minnesota has taken a similar but more comprehensive approach by providing a sample protective order for the parties to work from in crafting an order tailored to the needs of their case. *See* D. Minn. Form 5. Appendix 2.4 contains default protective orders from the Northern District of California, the Northern District of Illinois, and the District of Minnesota, as well as the source code guidelines from the District of Delaware. They collectively illustrate the nuances of handling confidentiality issues in patent cases.

2.1.2.1.2 Substance—Tier Structure

The Northern District of California's multitiered default protective order illustrates the model. It distinguishes among three tiers: (1) “Confidential” information (information that qualifies for protection under Federal Rule of Civil Procedure

26(c)); (2) “Highly Confidential — Attorneys’ Eyes Only” information (information that is “extremely sensitive,” disclosure of which “would create a substantial risk of serious harm that could not be avoided by less restrictive means”); and (3) “Highly Confidential — Source Code” information (“extremely sensitive” information “representing source code and associated comments and revision histories, formulas, engineering specifications, or schematics that define or otherwise describe in detail the algorithms or structure of software or hardware designs”). See N.D. Cal. Patent L.R. 2-2 Interim Model Protective Order. While “Confidential” information may be disclosed to parties and their representatives who sign an acknowledgment of the protective order, so long as it is used only for the purposes of litigation, “Highly Confidential—Attorneys’ Eyes Only” information may be disclosed only to in-house attorneys who are not involved in competitive decision making and whose identities are disclosed in advance. *Id.* “Highly Confidential—Source Code” information is made available for inspection pursuant to a strict set of guidelines, rather than produced, and is restricted to the same two in-house attorneys, as well as outside counsel and approved experts. *Id.*

Other courts have adopted a two-tier approach that does not explicitly identify source code. For example, the Northern District of Illinois adopted a default order that includes “Confidential” information (“information concerning a person’s business operations, processes, and technical and development information within the scope of Rule 26(c)(1)(G), the disclosure of which is likely to harm that person’s competitive position, or the disclosure of which would contravene an obligation of confidentiality to a third person or to a Court”) and “Highly Confidential” information (“information within the scope of Rule 26(c)(1)(G) that is current or future business or technical trade secrets and plans more sensitive or strategic than Confidential Information, the disclosure of which is likely to significantly harm that person’s competitive position, or the disclosure of which would contravene an obligation of confidentiality to a third person or to a Court”). See N.D. Ill. LPR Appendix B. While “Confidential” information may be disclosed to in-house counsel, “Highly Confidential” information may not, absent a court order. *Id.* The District of Minnesota has adopted a similar approach. See D. Minn. Form 5.

These and other default protective orders illustrate how courts commonly address the exchange of highly sensitive business and technical information in patent cases. Although some courts have adopted mandatory, default, or suggested protective orders, most districts allow the parties to negotiate and jointly propose the text of a stipulated protective order that the court then enters. Since confidentiality concerns vary from case to case, the court should be open to customizing provisions of default protective orders. Party disagreements on the substance of the protective order are usually limited to a few provisions, although there is potential in some cases for asymmetric interests in protecting confidentiality (such as when only one party is actively bringing new products to market). Courts can resolve such disputes by discussing with the parties the types of information they expect to produce and the confidentiality concerns that flow from that production. The court can then craft its protective order to address those specific issues in each case.

2.1.2.1.3 Prosecution Bars

In situations where an attorney represents a party both in litigation and in front of the Patent and Trademark Office in prosecution or postgrant review proceedings, it may be appropriate to include a “prosecution bar” in the protective order. This provision limits the ability of those who have seen designated material to engage in prosecution activities for a certain amount of time. Section 4.2.6.3 provides a detailed analysis of the considerations bearing on prosecution bars.

2.1.3 Managing Claim Winnowing and Construction of Claim Terms

Patent claims play a central role in patent cases, as they establish and delineate the intellectual property. Every patent ends with one or more claims (*see* § 112(b); § 14.1.1.3) and it is not uncommon for patents to contain a dozen or more claims. Each claim can support a patent infringement cause of action. Patent cases can allege infringement of multiple patents and multiple claims within each patent.

Disputes over the scope of patent claims can also complicate patent litigation. Parties often dispute the interpretation of words or “terms” within the claims. Disputes can arise as to the meaning of scientific and technical terms as well as common terms (such as “the” or “a”) within the context of the particular patent.

Early patent case management provides a critical opportunity to address both the number of patents and patent claims asserted and the scope of those claims. The former issue tends to arise most often in especially complex patent assertions, but there have been examples of single patents with more than a hundred claims that presented case-management challenges. Should the number of patents or patent claims present an issue, a plan for winnowing the range of asserted patent claims should be developed relatively early in the case. Section 2.1.3.1 addresses the key considerations in patent and claim winnowing while § 2.1.3.2 addresses the far more critical issue of patent claim construction. Table 2.1 summarizes the practical advantages and disadvantages of the most common approaches to claim winnowing and claim construction.

Table 2.1
Advantages and Disadvantages of the Most Common
Approaches to Claim Winnowing and Claim Construction

Approach	Strategy	Advantages	Disadvantages
Limiting number of patent claims to be litigated	Phased winnowing of patent claims asserted.	Avoids complexity and duplicative claims.	May have to be revisited if unique issues as to liability or damages arise relating to claims that were removed.
Identification of disputed claim terms	Parties identify to each other claim terms to be construed.	May help narrow disputed terms.	Requirement to confer may extend time required for claim construction.

Approach	Strategy	Advantages	Disadvantages
Identification of proposed constructions and evidence	Parties identify to each other their proposed constructions along with the intrinsic and extrinsic evidence on which they intend to rely, then confer.	May help narrow disputed terms.	Requirement to confer may extend time required for claim construction.
Claim term selection criteria	Limiting the number of claim terms.	May help focus the parties on the terms most likely to be critical to decisions on the merits. In some cases, a phased approach may mitigate the disadvantages.	May result in some important disputes remaining unresolved, thereby decreasing the parties' ability to evaluate their probability of success (and thus hindering settlement) until late in the case. <i>See O2 Micro Int'l Ltd. v. Beyond Innovation Tech. Co.</i> , 521 F.3d 1351, 1360–61 (Fed. Cir. 2008) (holding that all material claim-construction disputes must be resolved by the court prior to submission of the case to the jury).
Submission of joint statement of proposed constructions	Parties submit a joint claim-construction statement providing (a) a list of stipulated constructions; (b) the proposed constructions of each side for the disputed terms; and (c) the intrinsic and extrinsic evidence on which they intend to rely.	Forces the parties to identify the key disputed issues and evaluate the strength of the evidence in advance of burdening the court with briefing. Reduces the number of times parties change claim-construction positions during the briefing process. Provides the court with a useful roadmap of the upcoming briefing.	Extra submission may extend time required for claim construction and, depending on the schedule and the spillover from fact discovery, may force the parties to take positions before they have fully considered the issues.
Limiting the number of prior art references	Phased winnowing of prior art references that may be asserted at trial.	Reduces the cost and complexity of litigation and trial.	May unduly impair defendants' ability to challenge patent validity.

Approach	Strategy	Advantages	Disadvantages
Briefing	(a) Page limits, (b) simultaneous opening and opposing briefing without replies.	(a) May help focus issues and force the parties to avoid extraneous material; (b) can reduce the time needed for claim construction; and (c) gives both parties an equal chance to have the last word in a situation where neither side is really properly considered the movant.	(a) May prevent the parties from providing sufficient context into how the dispute over the proper construction is expected to influence the ultimate disputed issues of infringement and validity; and (b) can result in opening briefs that do not squarely address each other (generally the result of inadequate meeting and conferencing in an earlier stage).
Technical Tutorial	Court receives an in-person or submitted (on paper or through multimedia) presentation regarding the technology. Recording the tutorial is useful.	Provides the court with context to help make better decisions about the meaning of highly technical and possibly unfamiliar terms. Submitted or recorded tutorials can be provided to new judicial clerks, as patent cases usually outlast any individual clerk's tenure. In addition, a recorded tutorial can be part of the appellate record.	Increases the burden on the court. Tutorials can be expensive for parties to produce. The parties will likely present information in a way that favors their view about the proper framework for approaching the technical issues.

2.1.3.1 Patent and Claim Winnowing

Claim winnowing has emerged in a relatively small, but growing, subset of cases in which patentees assert a large raft of patents and/or patent claims. *See, e.g., Hearing Components, Inc. v. Shure, Inc.*, 2008 U.S. Dist. LEXIS 109230, 2008 WL 2485426, at *1 (E.D. Tex. June 13, 2008) (limiting plaintiff to three claims per asserted patent); *Fenster Family Patent Holdings, Inc. v. Siemens Med. Sols. USA, Inc.*, 2005 U.S. Dist. LEXIS 20788, 2005 WL 2304190, at *3 (D. Del. Sept. 20, 2005) (limiting plaintiff to ten patent claims and five asserted products). In one notoriously complex case, the patentee asserted 1,975 claims from more than a dozen patents against 165 defendants in 50 groups of related defendants. *See In re Katz Interactive Call Processing Pa-*

tent Litig., 639 F.3d 1303, 1309 (Fed. Cir. 2011). Many of the patents and patent claims substantially overlapped. The district court ordered the patentee to winnow the number of patent claims being asserted—initially requiring selection of no more than forty claims per defendant group, with further winnowing down to sixteen claims per defendant group following discovery, subject to various provisos. The Federal Circuit condoned this practice provided that the district court’s method for requiring the patentee to select claims allowed the patentee the opportunity to add claims that presented unique issues as to liability or damages. *Id.* at 1312–13; *see also Stamps.com Inc. v. Endicia, Inc.*, 437 F. App’x 897, 902–03 (Fed. Cir. 2011) (district court did not abuse its discretion by limiting a patentee to fifteen claims because the limit was not “immutable.”). Some courts require some limitation of the number of asserted patent claims prior to claim construction, with a further limitation required after claim construction and yet a further limitation before trial. This step-wise approach allows the plaintiff to refine its theories as the case progresses through discovery, claim construction, and dispositive motions.

In 2013, the Federal Circuit Advisory Council promulgated a broader framework for streamlining patent cases, reducing the complexity of patent cases, and reducing litigation costs. *See Model Order Limiting Excess Patent Claims and Prior Art* (Fed. Cir. Advisory Council, 2013) (contained in Appendix D). The Model Order, which reflects the recommendations of the Federal Circuit Advisory Council, but not necessarily the views of all members of the Federal Circuit, and is not binding on district courts, provides a framework for managing the number of claims litigated, the number of prior art references that are presented, the number of claim terms that may be construed, and the number of accused products at issue.

The Model Order provides a phased process for winnowing the number of asserted patent claims:

- “Not later than 40 days after the accused infringer is required to produce documents sufficient to show the operation of the accused instrumentalities, the patent claimant shall serve a Preliminary Election of Asserted Claims, which shall assert no more than ten claims from each patent and not more than a total of 32 claims.”
- “Not later than 28 days after the Court issues its Claim Construction Order, the patent claimant shall serve a Final Election of Asserted Claims, which shall identify no more than five asserted claims per patent from among the ten previously identified claims and no more than a total of 16 claims.”

Model Order Limiting Excess Patent Claims and Prior Art §§ 2, 3 (Fed. Cir. Advisory Council, 2013) (contained in Appendix D).¹ The Model Order encourages parties to discuss lower limits based on “case-specific factors such as commonality among asserted patents, the number and diversity of accused products, the complexity of the technology, the complexity of the patent claims, and the complexity and number

1. The Model Order relaxes these limitations when only one patent is asserted, increasing the per-patent limits “by 50%, rounding up.” Model Order Limiting Excess Patent Claims and Prior Art § 4 (Fed. Cir. Advisory Council, 2013).

of other issues in the case that will be presented to the judge and/or jury. In general, the more patents that are in the case, the lower the per-patent limits should be. The parties shall jointly submit any proposed modifications in their Federal Rule of Civil Procedure 26(f) Discovery Plan.” *See id.* at n.1.

Not every patent case will need this formal, phased procedure to winnow its claims. However, for complex cases, the Model Order provides a framework to adapt to the circumstances of the particular case.

2.1.3.2 Claim Construction

Construing patent claim terms has long been a key aspect of patent litigation and arises in almost every patent case. Since the mid-1990s, a growing number of courts have opted to construe patent claim terms prior to trial. This was a reaction to the rise of jury trials to resolve patent cases in the 1980s, which created a problem for the district judge and Federal Circuit in reviewing a jury’s determination. The scope of patent claims was often shrouded in the secrecy of jury deliberations. The district judge and the Federal Circuit had little basis on which to assess the jury’s construction of patent claims.

The Supreme Court’s seminal decision in *Markman v. Westview Instruments, Inc.*, 517 U.S. 370, 391 (1996), took claim construction out of the jury’s hands and put the responsibility squarely on the district judge to construe patent claim terms. More recently, *Teva Pharmaceuticals USA, Inc. v. Sandoz, Inc.*, 135 S. Ct. 831 (2015), not only confirmed that district courts were authorized to resolve subsidiary factual issues underlying claim construction, but held that such findings of fact should be upheld unless they are clearly erroneous.

Given this allocation of decision-making authority, it often makes sense for the district judge to construe the patent claim terms significantly in advance of trial, for several reasons. This practice enables the parties to understand the key issues for trial more thoroughly and can guide the preparation of expert reports. In addition, claim construction can provide the basis for summary judgment, potentially simplifying or resolving the case. Early claim construction also enables the court and the parties to begin to prepare jury instructions.

We explore the early case-management aspects of claim construction in this chapter. Chapter 5 focuses on substantive issues relating to claim construction as well as the conduct of the hearing.

To structure and facilitate the claim-construction process, more than thirty districts have adopted patent local rules (PLRs) setting forth a standardized timeline and framework for disclosures and submissions leading up to a claim-construction or “*Markman*” hearing. Appendix D lists, and links to, these local rules as well as exemplars. While the specific timing, sequence, and content of disclosures and submissions vary among districts, patent local rules share a basic principle—they seek to present the court with a limited set of actual and meaningful disputes. *See generally* James Ware & Brian Davy, *The History, Content, Application and Influence of the Northern District of California’s Patent Local Rules*, 25 Santa Clara Comp. & High Tech. L.J. 965 (2009) (providing a detailed account of the evolution of the Northern

District of California’s patent local rules, the first and most influential local rule initiative).

The impetus for PLRs was a clash between the liberal notice pleading policy² underlying the Federal Rules of Civil Procedure and the need for patent litigants to receive more specific notice of the issues they were litigating. *See, e.g., O2 Micro Int’l Ltd. v. Monolithic Power Sys.*, 467 F.3d 1355, 1365–66 (Fed. Cir. 2006). The plaintiff has not traditionally been required to specify which claims are infringed. Nor has the plaintiff needed to plead its theory of the meaning of the claim terms and the features of the defendant’s products that are alleged to infringe. Because a plaintiff may assert infringement of multiple claims in multiple patents, a defendant reading a notice pleading complaint is typically left to guess the boundaries of a plaintiff’s case and the available defenses.

A patent plaintiff reading a notice pleading answer and counterclaim is equally in the dark about the substance of the defendant’s case. The defendant, for example, need not identify the prior art on which its invalidity defense relies. Nor does the defendant have to plead its theories of claim construction or which combinations of prior art references might invalidate each of the claims. Only the defense of unenforceability due to inequitable conduct in the procurement of the patent must be pled with particularity because it is viewed as a species of fraud. *See Exergen Corp. v. Wal-Mart Stores, Inc.*, 575 F.3d 1312, 1329 (Fed. Cir. 2009); *but cf.* D.N.H. SPR 2.1(a) (requiring any complaint (or counterclaim) for patent infringement to contain a list of all accused products or processes and at least one illustrative asserted patent claim (per asserted patent) for each product or process).

Initial disclosures required under Federal Rule of Civil Procedure 26 do not alleviate this problem. Implementing routine discovery procedures such as service of contention interrogatories or expert discovery could ultimately provide the necessary information. However, contention interrogatories are often not required to be meaningfully answered until the late stages of discovery. And expert discovery is most efficiently conducted after fact discovery makes it possible to narrow the issues.

As a result, absent forced, early substantive disclosure, patent litigants have been known to engage in a “shifting sands” approach to litigation based on “vexatious shuffling of positions.” *See LG Elecs., Inc. v. Q-Lity Computer, Inc.*, 211 F.R.D. 360, 367 (N.D. Cal. 2002). Litigants may offer initial, substantially hedged, theories of infringement or invalidity, only to change those theories later by asserting different patent claims, different prior art, or different claim constructions, if their initial positions founder. Resulting extensions of fact and expert discovery can unduly prolong the litigation, unnecessarily sapping the court’s and the parties’ resources.

PLRs were developed to facilitate efficient discovery by requiring patent litigants to promptly disclose relatively specific bases underlying their claims. By requiring parties to disclose contentions in an orderly, sequenced manner, PLRs counter the

2. Note that changes to the Federal Rules of Civil Procedure, including the abolition of Rule 84 and the Appendix of Forms (including Form 18, the form patent infringement complaint), that took effect on December 1, 2015, will reduce this tension.

“shifting sands” tendencies. Neither litigant can engage in a strategic game of saying it will not disclose its contentions until the other side reveals its arguments. In discussing the Northern District of California’s PLRs, the Federal Circuit explained that they are designed to require

both the plaintiff and the defendant in patent cases to provide early notice of their infringement and invalidity contentions, and to proceed with diligence in amending those contentions when new information comes to light in the course of discovery. The rules thus seek to balance the right to develop new information in discovery with the need for certainty as to the legal theories.

O2 Micro, 467 F.3d at 1365–66; see also *Nova Measuring Instruments Ltd. v. Nanometrics, Inc.*, 417 F. Supp. 2d 1121, 1123 (N.D. Cal. 2006) (“The [patent local] rules are designed to require parties to crystallize their theories of the case early in the litigation and to adhere to those theories once they have been disclosed.”).

PLRs adopted by a district, or by an individual judge as a standing order or a case-specific order, supplement the Federal Rules of Civil Procedure. Courts may modify the procedures dictated by PLRs as necessary to suit the issues presented in a particular case. See, e.g., N.D. Cal. Patent L.R. 1.2. All modifications, as well as the rules or standing orders, must, of course, be consistent with Federal Circuit case law to the extent an issue “pertains to or is unique to patent law.” See *O2 Micro*, 467 F.3d at 1364 (citing *Sulzer Textil A.G. v. Picanol N.V.*, 358 F.3d 1356, 1363 (Fed. Cir. 2004)). For example, Federal Circuit law was applied in cases addressing whether claim charts exchanged by parties pursuant to PLRs could be amended to add new statutory bases for invalidity and infringement. See, e.g., *Genentech, Inc. v. Amgen, Inc.*, 289 F.3d 761, 774 (Fed. Cir. 2002); *Advanced Cardiovascular Sys., Inc. v. Medtronic, Inc.*, 265 F.3d 1294, 1303 (Fed. Cir. 2001). In these situations, the Federal Circuit held that the sufficiency of notice regarding defenses or theories of liability under specific statutory provisions of patent law “clearly implicat[ed] the jurisprudential responsibilities of this court within its exclusive jurisdiction.” *Advanced Cardiovascular*, 265 F.3d at 1303; see also *In re Spalding Sports Worldwide, Inc.*, 203 F.3d 800, 803–04 (Fed. Cir. 2000) (applying Federal Circuit law to a question of attorney-client privilege between patentee and patent attorney).

PLRs promote efficient case management by requiring the patentee to disclose the basis for its infringement contention and the accused infringer to disclose the basis for patent invalidity defense relatively early in the litigation process. In addition to advancing the claim-construction process, these disclosures set natural boundaries for discovery. They encourage settlement by providing parties with a reliable look at the specific accusations being presented and the evidence supporting them. In addition, some districts establish presumptive limits on the number of claim terms that will be construed to focus the litigation and streamline case management.

It should be noted that PLRs are merely presumptive and not mandatory. Judges in PLR districts retain authority to vary the rules to accommodate distinctive challenges or opportunities posed by particular cases. See N.D. Cal. Patent L.R. 1-3 (“The Court may modify the obligations or deadlines set forth in these Patent Local Rules based on the circumstances of any particular case, including, without limitation, the simplicity or complexity of the case as shown by the patents, claims, products, or

parties involved. Such modifications shall, in most cases, be made at the initial case-management conference, but may be made at other times upon a showing of good cause.”). Experience has shown that attorneys in districts with PLRs generally appreciate the balance and clarity that the rules provide. As a result, modification requests are relatively rare. In fact, attorneys familiar with such rules often propose similar parameters for managing cases in districts without formal PLRs.

Table 2.2 depicts a typical timeline for a patent case utilizing patent-specific initial disclosures, a structured claim-construction briefing process including a joint claim-construction statement, and a *Markman* hearing. The process depicted here is consistent with the requirements of local patent rules in districts such as the Northern District of California and the Eastern District of Texas.³

Table 2.2
Patent Local Rules Timetable,
Northern District of California

(1) Case-Management Conference	Set by Court	Patent Local Rule
(2) Disclosure of Asserted Claims and Infringement Contentions	Within 10 days of (1)	3-1 & 3-2
(3) Invalidity Contentions	Within 45 days of (2)	3-3 & 3-4
(4) Identify Claim Terms to be Constructed	Within 10 days of (3)	4-1
(5) Preliminary Claim Constructions	Within 20 days of (4)	4-2
(6) Joint Claim-Construction Statement	Within 60 days of (3)	4-3
(7) Close of Claim-Construction Discovery	Within 30 days of (6)	4-4
(8) Opening Claim-Construction Brief	Within 45 days of (6)	4-5(a)
(9) Responsive Claim-Construction Brief	Within 14 days of (8)	4-5(b)
(10) Reply Claim-Construction Brief	Within 7 days of (9)	4-5(c)
(11) <i>Markman</i> Hearing	Within 14 days of (10)	4-6
(12) Claim-Construction Order	TBD by Court	N/A
(13) Produce Advice of Counsel, if any	Within 50 days of (12)	3-7

3. In March 2008, the PLRs for the Northern District of California were amended in two important respects, which are reflected in the text and table in this section. First, the concept of “preliminary” contentions has been eliminated in favor of reliance on the traditional practice of allowing amendments only for good cause. Second, in designating claim terms for construction, the parties are limited to ten terms, absent leave of court.

An accelerated timeline may be appropriate for less complex cases, for example where the technology is simple, or there is little dispute as to the structure, function, or operation of accused devices. Under a particularly streamlined plan, the parties would not make patent-specific initial disclosures or file joint claim-construction statements. The court might also forgo a *Markman* hearing and address claim construction as part of summary judgment. Table 2.3 provides an example of such a timeline. The decision to adopt an accelerated timeline is best made after discussing the substantive issues that will drive the case with the parties. *See* § 2.5; General Order 14-3 (E.D. Tex. Feb. 25, 2014) (creating a “Track B” accelerated discovery schedule for patent infringement suits in the Eastern District of Texas where the parties jointly agree such a schedule would be beneficial).

Table 2.3

Accelerated Patent Case-Management Timeline

(1) Case-Management Conference	Set by court
(2) Produce Opinion of Counsel, if any	Within 2 months after CMC
(3) Close of Fact Discovery	5 months after CMC
(4) Close of Expert Discovery	2 months after (3)
(5) Opening Briefs on Claim Construction and Summary Judgment	Within 30 days of (4)
(6) Responsive Briefs on Claim Construction and Summary Judgment	Within 14 days of (5)
(7) Reply Briefs on Claim Construction and Summary Judgment	Within 7 days of (6)
(8) Claim-Construction and Summary Judgment Hearing	Within 14 days of (7)
(9) Claim-Construction and Summary Judgment Order	TBD by court

Some districts, including several with substantial patent dockets (most notably Delaware,⁴ Eastern Virginia, and Western Wisconsin), have not established a district-wide, rules-based approach to contention and claim-construction discovery. Instead, they address these issues on a judge-specific basis or through standard written discovery. The feasibility of the standard written discovery approach is improved when the court conducts claim construction after the close of fact discovery because both contentions and supporting evidence provided in interrogatory responses are often updated through the end of (and, at times, after) the fact discovery period.

4. Chief Judge Stark (D. Del.) has issued standardized procedures for managing patent cases, form scheduling order, and case-management checklists that parallel and go beyond district-wide patent local rules. Appendix 2.2 contains these documents.

Where a court intends to conduct claim construction earlier in the case (which might be especially advantageous where construction of a claim term could be case dispositive, *see* § 5.1.1), a court in a district that does not have patent local rules should nonetheless require the parties to exchange their burden-of-proof contentions, their claim-construction positions, and their supporting evidence well in advance of the claim-construction briefing.

2.1.3.2.1 Winnowing Claim Terms

As is more fully explored in § 5.1.2.1.3, district courts have wide discretion to limit the number of claim terms at issue, at least provisionally. Restricting the scope of the *Markman* hearing focuses the court's attention on the key issues (which may dispose of the case) and allows a more prompt and well-reasoned ruling on the central matters in the case. A substantial body of experience has shown that allowing the parties wide discretion to brief all claim terms that are potentially at issue invites false or inconsequential disputes. Parties reflexively seek to avoid the risk of a waiver finding, if they refrain from raising peripheral disputes.

To focus patent litigation on the most salient issues, a growing number of courts have established a presumptive limit on the number of claim terms—typically ten—that will be presented at the *Markman* hearing. Some districts have revised their PLRs to require the parties to jointly identify ten terms “likely to be most significant to resolving the parties’ dispute, including those terms for which construction may be case or claim dispositive.” *See* N.D. Cal. Patent L.R. 1.2; *see also* N.D. Ill. LPR 4.1(b) (requiring parties to limit terms submitted for construction to ten, absent a showing of good cause). The default ten-term limit can be increased or decreased depending on the circumstances of the case. In addition, some courts require parties to explain *why* particular terms are case-dispositive or otherwise significant so as to provide the court with context for the claim-construction dispute as well as the basis for deciding whether early construction of particular claim terms is warranted. *See, e.g.*, Magistrate Judge John D. Love (E.D. Tex.), Standing Order Regarding Letter Brief and Briefing Procedures for Early *Markman* Hearing/Summary Judgment of Noninfringement Requests, http://www.txed.uscourts.gov/cgi-bin/view_document.cgi?document=21674.

The ten-term limit does not fix the total number of terms that can be construed before trial. Parties can seek to construe additional terms at later phases in the case. However, for purposes of the principal *Markman* hearing, selecting the most significant terms allows courts to resolve the key disputes in the case most efficiently.

2.1.3.2.2 Claim-Construction Briefing and Oral Argument

Most district courts routinely utilize a *Markman* briefing coupled with a hearing, which typically consists of an argument of counsel and may include witness testimony, although this has been rare. Other courts do not hold a *Markman* hearing unless they determine from briefing that it would be helpful, such as when the experts sharply diverge on the perspective of a person of ordinary skill in the art. Many courts find it useful to have the parties first present a technology tutorial that sets the

stage for the arguments that follow. Some courts will let the relevant claim terms emerge in briefing. Others do more to encourage the parties to reach agreement in advance on a set of disputed terms, for example, by requiring submission of joint claim-construction statements. See N.D. Cal. Patent L.R. 4-3. A district judge has broad discretion to manage the claim-construction process, which is reflected in the variety of mechanisms that courts have used. A court's decisions about claim timing and process should, however, consider the interrelation of claim construction with other aspects of the pretrial process, particularly discovery, summary judgment, and settlement.

The Supreme Court's decision in *Teva Pharmaceuticals USA, Inc. v. Sandoz, Inc.*, 135 S. Ct. 831 (2015), expressly recognizes that district courts might engage in fact-finding during claim construction and that the *Markman* process might involve evidentiary hearings and expert declarations. See J. Jonas Anderson & Peter S. Menell, *Restoring the Fact/Law Distinction in Patent Claim Construction*, 109 Nw. U. L. Rev. Online 185 (2015). Appreciating the ramifications of the *Teva* decision requires understanding the perspective from which patent claims are interpreted and the Federal Circuit's past application of the *Markman* decision.

Courts interpret patent claims from the perspective of persons having ordinary skill in the art as of the time of the invention. See *Multiform Desiccants, Inc. v. Medzam, Ltd.*, 133 F.3d 1473, 1477 (Fed. Cir. 1998). Since few judges have such training and knowledge, they must step into the shoes of skilled artisans. As Professor William Callyhan Robinson explained more than a century ago, the court may look to: [T]estimony to explain the meaning of its language, or to expert evidence to ascertain the essential characteristics of the described invention and the differences between it and other patented inventions, or to papers in the Patent Office which are connected with the patent . . . to show the significance which [the inventor] attached to the terms.

3 William C. Robinson, *The Law of Patents for Useful Inventions* 248 (1890). In its *Markman* decision, the Supreme Court recognized the mixed fact/law character of claim construction. See *Markman*, 517 U.S. at 389–90 (characterizing claim construction as a “mongrel practice”).

Yet following the *Markman* decision, the Federal Circuit heavily discounted the use of extrinsic evidence, warning that “[a]llowing the public record to be altered or changed by extrinsic evidence introduced at trial, such as expert testimony, would make this right meaningless.” *Vitronics Corp. v. Conceptoronic, Inc.*, 90 F.3d 1576, 1583 (Fed. Cir. 1996). The Federal Circuit reinforced that holding in ruling, en banc, that claim construction is a pure question of law. *Cybor Corp. v. FAS Techs., Inc.*, 138 F.3d 1448 (Fed. Cir. 1998) (en banc); *Lighting Ballast Control LLC v. Philips Elecs. N. Am. Corp.*, 744 F.3d 1272 (Fed. Cir. 2014) (en banc).

In overruling these decisions, the Supreme Court restored the fundamental principle, reflected in Federal Rule of Civil Procedure 52(a)(6), that courts of appeals uphold a district court's findings of fact unless they are clearly erroneous. See *Teva*, 135 S. Ct. at 835–38. As a result, district courts now have greater leeway to use traditional evidentiary techniques to determine how persons skilled in the technical arts relating to the claimed invention would have understood the claim terms at the time the invention was made. In the wake of the *Vitronics* and *Cybor* decisions, district courts

avoided such evidentiary processes. Now, after *Teva*, district courts have leeway to use evidentiary hearings and other fact-finding techniques to resolve disputes as to how skilled artisans would have understood a claim term within the context of the patent at the time the invention was made.

It will be important, however, to recognize the primacy of the intrinsic evidence—the patent document and the prosecution history—in construing patent claims for two reasons. First, the Supreme Court emphasized that the intrinsic evidence overrides extrinsic evidence where the two diverge. This is consistent with the Federal Circuit’s en banc decision in *Phillips*, which held that intrinsic evidence takes precedence over extrinsic evidence and dictionaries. See *Phillips v. AWH Corp.*, 415 F.3d 1303 (Fed. Cir. 2005) (en banc); § 5.2.2. Second, opening up the *Markman* process to evidentiary hearings whenever a party offers expert testimony could greatly complicate claim construction and waste resources.

Building on its *Markman* framework, the Supreme Court’s *Teva* decision endorses a hybrid standard: factual determinations underlying claim-construction rulings are subject to the “clearly erroneous” (or “abuse of discretion”) standard of review, while the Federal Circuit exercises de novo review over the ultimate claim-construction decision. In this manner, district judges can use their distinctive vantage point and evidentiary tools to ferret out factual underpinnings while the Federal Circuit can operate as a check on fidelity to the patent instrument. Therefore, even though the Federal Circuit retains de novo review of whether a trial court’s construction of a patent claim comports with the intrinsic evidence, the appellate court must nonetheless sustain the trial court’s subsidiary factual findings unless clearly erroneous. In cases where it is necessary to go beyond the intrinsic evidence to interpret claim meaning, the district court’s resolution, if adequately grounded in extrinsic evidence, will control.

Where the court determines that a claim term warrants construction and subsidiary fact-finding would be valuable, the court should: (1) seek to delineate the disputed subsidiary factual questions prior to the *Markman* proceeding, (2) conduct focused briefing with supporting expert declarations and evidentiary hearings to create an adequate record for resolving such disputes, and (3) prepare a careful *Markman* order explaining the basis for their claim construction.

As noted above, the *Teva* framework presents the risk of greater cost and delay as parties engage in escalating battles of the experts. Such problems, however, are not unique to patent adjudication, although the technological complexity of patent cases creates greater opportunity for such tactics. District judges must not lose sight of intrinsic evidence’s central role in claim construction, and must exercise due caution in entertaining extrinsic evidence.

It is important to recognize that parties dispute the construction of a variety of types of claim terms. Experience has shown that many of the disputed terms that are appealed to the Federal Circuit are not technical or scientific terms, but common terms whose meaning becomes disputed within the context of the particular patent claim.

Scientists and engineers usually have relatively clear understandings of many scientific or technical terms as used in their fields, even though such terms may be

beyond a district judge's general experience. Scientists or engineers who take unjustified positions, particularly with respect to common terms, risk that federal judges will impugn their credibility. Since *Markman* testimony would not occur before a jury, district judges have substantial leeway to press the experts to clarify their positions. Over time, this possibility should help district judges understand any technical issues that underlie the parties' contentions and better determine whether the correct construction is one party's proposal, the other's, or neither party's.

The *Teva* decision arguably places a greater onus on district judges to understand and explain how they parse claim language. The decision affords them greater flexibility to use familiar tools for resolving factual disputes—presentation of evidence and expert testimony. At the same time, it may demand that they show how disputed subsidiary facts relate to the intrinsic evidence. Ultimately, this framework should add to the reliability of the dispute resolution process by bringing better evidence, more scrutiny, and fuller explication to bear on claim construction.

2.1.3.2.3 Claim Construction and Discovery

2.1.3.2.3.1 Discovery Prior to Claim Construction

As Chapter 5 explores more thoroughly, claim construction is based on the patent claims, specification, prosecution history, and, in some cases, on extrinsic evidence to reconstruct what patent claim terms would have meant to a person skilled in the art. In theory, therefore, discovery relating to the structure and function of accused devices or a patent holder's own products might seem unnecessary. See *SRI Int'l v. Matsushita Elec. Corp. of Am.*, 775 F.2d 1107, 1118 (Fed. Cir. 1985) (en banc). However, often, only by knowing the details of the accused product and the relevant prior art can the parties determine which claim terms need construction. Otherwise, the court might be asked to provide definitions for words and phrases that are unlikely to materially affect the outcome of the litigation. Likewise, an inventor's testimony as to what a patent means is typically seen as extrinsic evidence. The claim-construction process gives this testimony less weight, particularly when it is offered in a self-serving way. It can, however, help the court understand the context and background of an invention as well as what the inventor understood to be the point of novelty. In some cases, an inventor's deposition can also illuminate what happened during prosecution of the patent application, which in turn can shed light on the meaning of some terms.

The Supreme Court's *Teva* ruling has expanded the use of expert declarations and testimony in claim construction. As a result, it can be particularly useful to a court to ask the parties early in the claim-construction process if they intend to rely on expert testimony and, if so, what the substance of the testimony will be. The court will then be in a position to evaluate the need for such testimony. If the court already plans to have an expert tutorial in conjunction with the *Markman* hearing, it can leave its options open by informing the parties that it might take evidence from the experts should factual confusion or disputes arise. Since the *Markman* process does not involve juries, the court has greater flexibility in structuring the proceeding. For instance, the court can use the so-called "hot tub" method, in which the court asks

the opposing technical experts to address directly each other's testimony and the judge's questions to sharpen and clarify the disputed issues and assess the credibility of the witnesses. Of course, depending on the case and the claim terms in dispute (e.g., technical versus common terms), claim construction may not benefit from expert testimony, and in those situations, the court may choose to exercise its discretion and not allow it, or limit it to the resolution of particular terms.

In practice, permitting fact discovery in advance of claim construction helps focus the claims and defenses in a case. For example, once a plaintiff has discovery on the structure and function of accused products or processes, it may eliminate certain claims that it initially intended to assert. It can prioritize the claim terms that will best bridge the gap between the parties' views regarding the value of the litigation. Accordingly, discovery in advance of claim construction is common. Indeed, the specialized local patent rules of most districts that have adopted them expressly provide for discovery prior to claim construction, including mandated early disclosures of infringement and invalidity contentions. It can be helpful for a court to discuss potential limits on or phasing of pre-claim-construction discovery with the parties. In some cases, it could be wasteful to devote substantial resources to discovery on issues unrelated to claim construction (e.g., damages, equitable defenses, and willfulness) when the claim-construction ruling could be dispositive or drive settlement.

2.1.3.2.3.2 Fact Discovery After Claim Construction

Often, as a result of a court's claim-construction order, issues arise which justify additional fact discovery. For example, the court's definition of a disputed claim term might implicate previously uninvestigated features of an accused device because a court is not limited to choosing between constructions proposed by the parties. Most courts, therefore, set fact discovery to proceed for some period after the expected ruling on claim construction. Courts managing cases in which an inventor is deposed for *Markman* purposes sometimes limit that initial deposition to claim-construction-related topics, and allow a more general deposition after the *Markman* process is complete.

2.1.3.2.3.3 Expert Discovery After Claim Construction

Expert reports on infringement, invalidity, and damages are central to almost every patent case. Technical experts opine on infringement and invalidity based on the meaning of the claim terms as determined by (or anticipated from) the court's claim-construction order. For this reason, claim construction should precede expert reports and depositions. Claim construction might also affect damage analyses. For example, as a result of the court's ruling, it might become apparent that certain accused devices or features do not infringe or that a hypothetical design-around might have been easier or more difficult. Many courts, therefore, schedule expert discovery and depositions to begin after claim construction. In other jurisdictions, courts set expert discovery before claim construction but require experts to write their reports in the alternative relative to each side's proposed constructions.

2.1.3.2.3.4 Legal Contentions After Claim Construction

In many cases, the legal theories on infringement or invalidity adopted by the parties may not work as well as a litigant expected after claim construction. In some cases or jurisdictions—especially those in which claim construction happens at the end of the case and/or in connection with summary judgment—the parties are provided only limited opportunities to change infringement and invalidity theories after claim construction. This forces the parties to think hard about their case early in the litigation and to settle on a particular theory. For that reason, it also prevents sandbagging. On the other hand, limiting the parties’ ability to modify their legal theories after claim construction can result in a trap for the unwary and/or harshly deprive a party of an otherwise valid claim or defense. This is especially true when, as is often the case, the court adopts constructions that differ from *both* sides’ proposals. The parties may not have anticipated the court’s constructions and find that the construction has broken their theories.

For this reason, many courts allow parties to modify their infringement and invalidity contentions after claim construction, but require a “timely showing of good cause” to do so. *See, e.g.*, N.D. Cal. Patent L.R. 3-6; *see also O2 Micro*, 467 F.3d at 1366 (Fed. Cir. 2006) (affirming lower court’s requirement that a party show diligence in order to establish “good cause” under local patent rules); *Finisar Corp. v. DirecTV Grp.*, 424 F. Supp. 2d 896, 901–02 (E.D. Tex. 2006) (“Invalidity is an affirmative defense, and the party which does not properly investigate applicable prior art early enough to timely meet disclosure requirements risks exclusion of that evidence.”).

2.1.3.2.4 Claim Construction Generally Should Precede, but May Be Combined with, Summary Judgment

Claim construction is a critical predicate to the most common summary judgment motions. Indeed, the structure and operation of an accused device is often undisputed so that the determination of infringement will collapse into a question of claim construction. *Athletic Alternatives, Inc. v. Prince Mfg., Inc.*, 73 F.3d 1573, 1578 (Fed. Cir. 1996). The same can be true for invalidity. Claim construction is the foundation for analysis of both infringement (has the patentee claimed the technology practiced by the defendant?) and invalidity (does the patentee’s claim “read on”⁵ preexisting technology?). Most courts complete claim construction first, before allowing dispositive motions, on the theory that the parties need a definitive statement of claim scope before preparing summary judgment papers. It can be a significant burden to prepare a motion for summary judgment—including the supporting statements of undisputed material facts and declarations from fact and expert wit-

5. The phrase “read on” is a term of art in patent law. If an accused device, manufacture, composition, or process embodies each element of a patent claim (and hence infringes), the claim is said to “read on” it. Similarly, a patent claim “reads on” a prior art reference (and hence is invalid) if the prior art reference contains each of the claim limitations.

nesses—that takes into account multiple, potential constructions of key terms. Motions prepared with the claims already construed can be more focused on the reasons summary judgment is justified, and better fit within court-prescribed page limits. Other courts emphasize the risk that separate, isolated claim construction, done without a sufficient understanding of why and how the dispute about the meaning of a term *matters*, results in an abstract exercise that is more likely to be wrong. As a result, these courts combine the claim-construction and summary judgment proceedings. Alternatively, a few courts do not schedule dispositive motions for the same time as claim construction. They do, however, require the parties to explain the significance of the competing claim constructions and limit their ability to offer alternative theories of infringement or noninfringement that were not previously disclosed. Although there are substantial reasons to prefer an early claim construction (such as the ability to provide clarity and information on settlement value to litigants earlier in the case), it is also worth noting the Federal Circuit’s position that claim constructions are not ripe for appellate review until the full factual record has been developed. *See, e.g., Wilson Sporting Goods Co. v. Hillerich Bradsby Co.*, 442 F.3d 1322, 1327 (Fed. Cir. 2006). For that reason, early claim construction does not normally allow pretrial review of this interlocutory decision, even on a writ.

As explored more fully in Chapter 6, some experienced patent jurists have found it useful to distinguish between two kinds of summary judgment motions: (1) those that turn primarily or exclusively on claim construction—such as noninfringement (e.g., whether the claimed invention reads on the accused device)—and (2) those that turn principally on issues other than claim construction. These jurists have found that it is most efficient to combine the first set of summary judgment motions with claim construction. *See* § 6.1.2; *cf. MyMail, Ltd. v. Am. Online, Inc.*, 476 F.3d 1372, 1378 (Fed. Cir. 2007) (“Because there is no dispute regarding the operation of the accused systems, that issue reduces to a question of claim interpretation and is amenable to summary judgment.”); *Gen. Mills, Inc. v. Hunt-Wesson, Inc.*, 103 F.3d 978, 983 (Fed. Cir. 1997) (“Where the parties do not dispute any relevant facts regarding the accused product . . . but disagree over possible claim interpretations, the question of literal infringement collapses into claim construction and is amenable to summary judgment.”). These jurists address these motions either simultaneously with claim construction or immediately thereafter and consider the second category of summary judgment motions at another time, depending on other scheduling concerns, such as discovery.

2.1.3.2.5 Claim Construction May Encourage Settlement

One argument in favor of early, separate claim construction is that it may facilitate settlement. This may be more likely following the Supreme Court’s *Teva* decision, which defers to district court claim constructions on subsidiary factual determinations. In some cases, it may be appropriate to conduct an early claim construc-

tion for a subset of the disputed claim terms that are deemed case-dispositive.⁶ A court's rulings on claim scope can help the parties recalibrate their assessment of exposure and allow each side to take a fresh look at its case. As a result, it may be fruitful to schedule a settlement conference shortly after issuance of a claim-construction order. *See* § 2.4. This can be especially effective where one side (generally the defendant) identifies a single issue as its strongest argument for an outcome in its favor. If the defendant raises this issue during the initial CMC, and the court schedules an early claim construction followed by summary judgment on that single issue, it may substantially reduce the overall cost of the litigation. This procedure, however, should only be used where the defendant can convincingly explain *why* the case largely turns on a single disputed issue. Otherwise, there is potential for abuse in a request for limited claim construction and an early dispositive motion because defendants have an incentive to use the procedure to get the court to decide separately multiple attacks on the patent. On the other hand, it is also true that plaintiffs have an incentive to resist scheduling such a motion early in the case, not because the motion will not be dispositive, but because the plaintiff may hope to use the nuisance cost and disruption of the litigation to extract a larger settlement from the defendant. Thus, while this procedure can be very effective in the right cases, it should be deployed only after closely examining its potential positive and negative effects in the particular case.

2.1.3.2.6 Preliminary Injunction Motions Usually Require Preliminary Claim Construction

Preliminary injunction motions in patent cases typically require a court to construe claim terms on an accelerated schedule. Briefing usually includes the parties' positions on key claim terms (albeit less informed than they might have been through discovery, as explained above), and a court's decision to grant or deny the motion will often hinge on claim-construction issues. However, these preliminary constructions are not binding. *Sofamor Danek Grp., Inc. v. DePuy-Motech, Inc.*, 74 F.3d 1216, 1221 (Fed. Cir. 1996). Subsequent, more detailed briefing and analysis may lead a court to reconsider and revise constructions applied in a preliminary injunction motion. *See CVI/Beta Ventures, Inc. v. Tura LP*, 112 F.3d 1146, 1160 n.7

6. For example, the Eastern District of Texas invited a defendant to submit a letter brief requesting the court to construe no more than three case-dispositive terms. The court would then hold "an early *Markman* hearing on the identified case dispositive terms If the case is not resolved following the Court's claim construction summary judgment rulings, a *Markman* hearing, as set forth in the Docket Control Order or at the patent status conference, will occur as scheduled." *Glob. Sessions LP v. Travelocity.com, LP et al.*, 2011 U.S. Dist. LEXIS 155901 (E.D. Tex. Aug. 18, 2011); *see also Parallel Networks v. AEO, Inc.*, No. 6:20cv275-LED-JDL (E.D. Tex. Mar. 15, 2011) (ordering a *Markman* hearing on a small number of claim terms; reasoning that the hearing would "resolve several important issues at a beneficial time for each party to better evaluate its case").

(Fed. Cir. 1997); *see also* § 5.3.2.4.1. We explore the preliminary injunction stage of patent litigation in Chapter 3.

2.1.4 Managing the Parties' Claims, Defenses, Prior Art References, and Counterclaims

Patent local rules, standing orders, and the Federal Circuit Advisory Council's model order address a variety of more specific disclosure and case-management practices. This section explores several notable practices.

2.1.4.1 Early Document Production

The local patent rules of several districts require parties to produce infringement and/or invalidity-related documents with their initial disclosures or otherwise very early in a case. Several notable examples are the Northern District of Illinois Local Patent Rules 2.1–2.4 (requiring patent plaintiffs to produce invalidity-related documents with their initial disclosures and accused infringers to produce infringement and invalidity documents with their initial disclosures); the Western District of Tennessee Local Patent Rule 3.1 (requiring the party claiming infringement to produce infringement-related documents seven days after the initial response is filed, along with infringement contentions); and the Northern District of Ohio Local Patent Rules 3.1–3.2 (requiring patent plaintiffs to produce invalidity-related documents within fifteen days after the answer is filed). Patent plaintiffs often favor early production requirements but must not let their own early production obligations catch them off guard.

2.1.4.2 Ownership and Standing

A number of jurisdictions require plaintiffs to produce all documents relating to ownership of the asserted patents. *See, e.g.*, N.D. Cal. Patent L.R. 3-2(d); D. Idaho L. Patent R. 3.2(d); N.D. Ill. LPR 2.1(a)(4); D. Nev. LR 16.1-7(d); D.N.H. SPR 5.1(b)(4); D.N.J. L. Pat. R. 3.2(d); N.D.N.Y. L. Pat. R. 3.2(d); N.D. Ohio L. P.R. 3.2(d); W.D. Tenn. LPR 3.2(d). Others frame the obligation more broadly by requiring production of all documents relating to “[t]he standing of the party alleging infringement with respect to each patent upon which such allegations are based.” *See* Maryland L.R. 804.1(b)(ii); *see also* S.D. Ohio Pat. R. 103.1(b)(5). More than just ownership documents, this requirement contemplates the production of licensing documents where an exclusive licensee may be bringing suit.

2.1.4.3 Joint Infringement

A majority of districts with local patent rules have provisions governing infringement contentions where joint direct infringement is alleged. Typically, a patentee plaintiff must describe “the role of each such party in the direct infringement.” *See* the local patent rules for the following districts: N.D. Cal. Patent L.R. 3-1(d); D.

Idaho Loc. Patent R. 3.1(d); N.D. Ill. LPR 2.2(e); Maryland L.R. 804.1(a)(iv); E.D. Mo. Local Patent R. 3.1(a)(v); D. Nev. LR 16.1-6(d); D.N.H. SPR 5.1(a)(2)(B); D.N.J. L. Pat. R. 3.1(d); N.D.N.Y. L. Pat. R. 3.1(d); E.D.N.C. L. Civ. R. 303.2(a); N.D. Ohio L. P. R. 3.1(d); S.D. Ohio Pat. R. 103.2(a)(5); W.D. Tenn. LPR 3.1(d); E.D. Wash. LPR 120(d); W.D. Wash. Local Patent Rule 120(d).

2.1.4.4 Winnowing Prior Art References

Just as the assertion of myriad patent claims unduly complicates patent litigation for the defense, the assertion of myriad prior art references, many of which will not be pursued, can impose undue cost on the patentee and the court. In conjunction with its efforts to rein in excessive numbers of asserted patent claims, the Federal Circuit Advisory Council proposed a phased process for winnowing the number of asserted prior art references:

- “Not later than 14 days after service of the Preliminary Election of Asserted Claims, the patent defendant shall serve a Preliminary Election of Asserted Prior Art, which shall assert no more than twelve prior art references against each patent and not more than a total of 40 references.”
- “Not later than 14 days after service of a Final Election of Asserted Claims, the patent defendant shall serve a Final Election of Asserted Prior Art, which shall identify no more than six asserted prior art references per patent from among the twelve prior art references previously identified for that particular patent and no more than a total of 20 references.”

Model Order Limiting Excess Patent Claims and Prior Art §§ 2, 3 (Fed. Cir. Advisory Council, 2013);⁷ *see also* D. Utah LPR 7.1 (“In its final pretrial disclosures, a party opposing infringement shall reduce the number of prior art references—and any combinations thereof—to be asserted in support of anticipation or obviousness theories to a manageable subset of previously identified prior art references. As a general rule, a manageable number of references per claim is no more than three (3) references.”).

2.1.4.5 Other Practices

Less common PLR provisions that may be useful case-management tools include:

- Requiring parties to submit summary judgment motions as part of the claim-construction process. D. Utah LPR 6.2.
- Requiring parties to “[p]rovide a written summary of any oral advice and produce or make available for inspection and copying that summary and

7. The model order relaxes these limitations when only one patent is asserted, increasing the per-patent limits “by 50%, rounding up.” Model Order Limiting Excess Patent Claims and Prior Art § 4 (Fed. Cir. Advisory Council, 2013) (contained in Appendix D).

documents related thereto for which the attorney–client and work product protection have been waived.” S.D. Cal. Patent L.R. 3.7(b).

- Requiring patent owners to make a damages disclosure. S.D. Ind. Patent Case Management Plan III(E) (which requires that plaintiffs must serve a “statement of damages” within 30 days after a *Markman* order).
- Requiring a production of “license agreements for the patents-in-suit.” S.D. Tex. P.R. 3-2(a)(4).
- Bifurcation is handled differently by different district courts. In the Southern District of Ohio, willful infringement is always bifurcated. *See* S.D. Ohio Pat. R. 107.2. The Northern District of Georgia expressly disfavors bifurcation of liability issues from damages issues. N.D. Ga. LPR 5.1. Most districts are silent on the issue, but the Western District of North Carolina suggests the parties should consider whether bifurcation is appropriate. W.D.N.C. P.R. 2.1(A)(7).

2.2 Complaint and Answer

Complaints and answers in patent cases are typically deceptively simple. Generally, the asserted patents are identified, and defendants are accused of infringing them. Complaints rarely detail the defendants’ allegedly infringing activities and facts about the parties’ interrelationships, although often critical to the practical resolution of the case, are not usually included absent allegations of inequitable conduct (which must be pled with particularity).

Nevertheless, a patent complaint may spawn a wide variety of early motion practice, including motions to dismiss relating to lack of standing, lack of actual case or controversy, necessary parties, and interactions with related legal actions. Motions to dismiss for failure to claim patentable subject matter are possible as well. *See In re Bilski*, 545 F.3d 943, 951 (Fed. Cir. 2008), *aff’d*, 561 U.S. 593 (2010); *see also* §§ 6.2.1.1.1, 14.3.1. To comprehend the underpinnings of the disputes that will be raised in these and subsequent motions, it often helps the court to understand the parties’ prior dealings and connections, if any. For example, often patent litigants have had a prior business relationship, such as through licensing or licensing discussions. Some courts find it helpful to explore these issues, as well as other business and market considerations, in an early case-management or settlement conference. Further, as the content of the patent infringement complaint is so sparse, it might also be helpful to explore case-specific substantive issues, such as the nature and complexity of the technology, and whether adoption of some variation on the patent local rules will help manage the case. Section 2.5 provides an expanded checklist of potential topics that might usefully be explored at an early conference with the parties.

On December 1, 2015, the U.S. Supreme Court adopted a number of amendments to the Federal Rules of Civil Procedure. Among these is the abolition of Rule 84 and the Appendix of Forms, including Form 18, the form complaint for patent infringement. The pleading standards set forth in *Twombly* and *Iqbal* now govern patent cases. This is discussed in further detail below.

2.2.1 Plaintiff Standing Requirements

The plaintiff may be the patent rights holder suing for infringement, or an accused infringer who challenges liability under the Declaratory Judgment Act, claiming the patent is invalid, unenforceable, and/or not infringed. Every plaintiff must have standing to sue for the case to proceed. Although it is advisable for a court to address standing issues early, they can arise at any time—and cannot be waived, because standing is jurisdictional. *See Pandrol USA, LP v. Airboss Ry. Prods., Inc.*, 320 F.3d 1354, 1367–68 (Fed. Cir. 2003).

2.2.1.1 Infringement Plaintiff

2.2.1.1.1 Infringement Plaintiff Must Hold All Substantial Patent Rights

A party suing for infringement must hold exclusive rights to the patent being asserted. A patent issues in the name of the inventor(s) or their assignee (usually an employer), who is then the “patentee.” Only a patentee can bring an action for patent infringement. § 281 (2012). The term “patentee” includes “not only the patentee to whom the patent was issued but also the successors in title to the patentee.” § 100(d). Courts also permit exclusive licensees to bring suit in their own name, if the exclusive licensee holds “all substantial rights” in the patent, becoming, in effect, an assignee (and therefore a “patentee” within the meaning of § 281). *See Textile Prods., Inc. v. Mead Corp.*, 134 F.3d 1481, 1484 (Fed. Cir. 1998). “All substantial rights” usually include the right to sue for infringement (without leave of the patent owner) and the right to grant licenses; courts look to the intention of the parties and examine the substance of what was retained by the owner and what was granted to the licensee in order to determine whether the licensee has obtained all substantial rights. *See Vaupel Textilmaschinen KG v. Meccanica Euro Italia SPA*, 944 F.2d 870, 874–75 (Fed. Cir. 1991). Because patent assignments must be in writing, § 261, an oral agreement cannot grant “all substantial rights” in a patent sufficient to confer standing. *See Prima Tek II, L.L.C. v. A-Roo Co.*, 222 F.3d 1372, 1377 (Fed. Cir. 2000).

Another’s infringement can still injure an exclusive licensee without all substantial rights. Therefore, they will have standing to sue, but only as a co-plaintiff with the patentee. *See Mentor H/S, Inc. v. Med. Device All., Inc.*, 240 F.3d 1016, 1017, 1019 (Fed. Cir. 2001); *cf. Propat Int’l Corp. v. Rpost US, Inc.*, 473 F.3d 1187 (Fed. Cir. 2007). A license that is not exclusive or that confers less than all the rights held under the patent cannot confer standing. *See Prima Tek II*, 222 F.3d at 1377–78.

2.2.1.1.2 Plaintiff Must Join All Joint Patent Owners

Ordinarily, all co-owners of a patent must consent for an infringement suit to be maintained. Where ownership of a patent is disputed, early motion practice may include an accused infringer’s motion to dismiss for failure to join a purported third-party co-owner of the patent. This may happen, for example, when the patent resulted from a joint development project, *see Katz v. Lear Siegler, Inc.*, 909 F.2d 1459,

1462 (Fed. Cir. 1990), or where there is a dispute as to whether the asserted patent claims were included within an assignment agreement. *See Isr. Bio-Eng'g Project v. Amgen Inc.*, 475 F.3d 1256, 1265 (Fed. Cir. 2007).

In such cases, the court must first determine ownership of the patent. “Ownership depends upon ‘the substance of what was granted’ through assignment.” *Id.* at 1265 (quoting *Vaupel Textilmaschinen*, 944 F.2d at 874). “In construing the substance of the assignment, a court must carefully consider the intention of the parties and the language of the grant.” *Id.* The agreement must be interpreted according to applicable state law. *See id.* (interpreting contract under Israeli law). If it is determined that an owner of the patent is not included as a plaintiff, the complaint must be dismissed. *Id.* (affirming summary judgment that plaintiff lacked standing where plaintiff lacked complete ownership interest and co-owner was not joined). As described below (§§ 2.2.1.1.6–2.2.1.1.7), such a dismissal should be without prejudice to refile an action with the jurisdictional defect corrected.

In *STC.UNM v. Intel Corp.*, the Federal Circuit reaffirmed the rule that all co-owners of a patent must consent to join as plaintiffs for an infringement suit to proceed. 754 F.3d 940, 945–46 (Fed. Cir. 2014) (citing *Ethicon, Inc. v. U.S. Surgical Corp.*, 135 F.3d 1456, 1467 (Fed. Cir. 1998)). Because “one co-owner has the right to impede the other co-owner’s ability to sue infringers by refusing to voluntarily join in such a suit,” a co-owner cannot ordinarily be joined involuntarily as a plaintiff under Federal Rule of Civil Procedure 19. *Id.* at 946 (quoting *Schering Corp. v. Roussel-UCLAF SA*, 104 F.3d 341, 345 (Fed. Cir. 1997)). The court noted two exceptions to the rule against involuntary joinder: (1) when the plaintiff is an exclusive licensee and seeks to join the patent owner, and (2) when a co-owner has waived the right to refuse to join suit by agreement. *Id.*

2.2.1.1.3 An Exclusive Licensee Must Sometimes Join Its Licensors

Where an asserted exclusive licensee who has less than all substantial rights sues for infringement in its own name, a defendant will frequently move to dismiss for failure to join the licensor as a necessary party. *See, e.g., Propat Int’l*, 473 F.3d at 1189–93; *Fieldturf, Inc. v. Sw. Recreational Indus. Inc.*, 357 F.3d 1266, 1268–70 (Fed. Cir. 2004); *see also Intellectual Prop. Dev., Inc. v. TCI Cablevision of Cal., Inc.*, 248 F.3d 1333, 1339–40 (Fed. Cir. 2001). An exclusive licensee receives more rights in a patent than a nonexclusive licensee, but may receive fewer rights than an assignee of all substantial patent rights. For example, an exclusive licensee could receive the exclusive right to practice an invention within a given limited territory. *Id.* An exclusive licensee has standing to sue, but must join the patent owner as a necessary party. *Id.* at 1348; *Propat*, 473 F.3d at 1193; *Mentor H/S, Inc.*, 240 F.3d at 1019.

If an exclusive licensee with less than all substantial rights has failed to join the patent owner, the action may be dismissed without prejudice, in anticipation of its refiling with the patent owner named as a co-plaintiff. Indeed, the Supreme Court has explained that:

[t]he owner of a patent, who grants to another the exclusive right to make, use, or vend the invention, which does not constitute a statutory assignment, holds title to the patent in trust for such licensee, to the extent that he *must allow the use of his name as plaintiff in any action brought at the instance of the licensee* in law or in equity to obtain damages for the injury to his exclusive right by an infringer, or to enjoin infringement of it.

Indep. Wireless Tel. Co. v. Radio Corp. of Am., 269 U.S. 459, 469 (1926) (emphasis added). Consequently, rather than dismissing the action, a court may grant a motion or cross-motion by the exclusive licensee for leave to amend to join the patent owner, either voluntarily or involuntarily. See *Intellectual Prop. Dev.*, 248 F.3d at 1347–48 (affirming district court’s grant of plaintiff-exclusive licensee’s motion for leave to amend to add patent owner as a party); see also *Abbott Labs. v. Diamedix Corp.*, 47 F.3d 1128, 1130–34 (Fed. Cir. 1995).

2.2.1.1.4 A Nonexclusive Licensee Has No Standing to Sue

[A] nonexclusive license or “bare” license—a covenant by the patent owner not to sue the licensee for making, using, or selling the patented invention and under which the patent owner reserves the right to grant similar licenses to other entities—confers no constitutional standing on the licensee under the Patent Act to bring suit or even to join a suit with the patentee because a nonexclusive (or “bare”) licensee suffers no legal injury from infringement.

Intellectual Prop. Dev., Inc. v. TCI Cablevision of Cal., Inc., 248 F.3d 1333, 1345 (Fed. Cir. 2001).

2.2.1.1.5 Patentee Can Only Convey Right to Sue by Transferring Substantially All Patent Rights

Assignment of a patent, or an exclusive license of a patent that conveys substantially all patent rights, conveys to the assignee or licensee the right to sue for present and future infringement of the patent. See *Propat Int’l*, 473 F.3d at 1189. A patent holder cannot, however, confer through assignment a right to sue for infringement—whether past, present, or future—separate from the conveyance of a proprietary interest in the patent. *Id.* at 1194 (citing *Crown Die & Tool Co. v. Nye Tool & Mach. Works*, 261 U.S. 24, 34–36 (1923)). As discussed above, to have standing to sue, a party must be an exclusive licensee or assignee of all substantial rights in a patent.

Further, because infringement harms only the owner of the patent at the time of the infringing acts, conveyance of the patent does not normally include the right to recover for injury occurring to the prior owner of the patent. *Minco Inc. v. Combustion Eng’g*, 95 F.3d 1109, 1117 (Fed. Cir. 1996). Thus, as a general rule, “the right to sue for *prior* infringement is not transferred unless the assignment agreement manifests an intent to transfer this right.” *Id.* (emphasis added). To determine if patent assignment includes the right to sue for prior infringement, the court should analyze the assignment according to state contract law. *Id.* “Neither statute nor common law

precedent, however, requires a particular formula or set prescription of words to express that conveyance.” *Id.*

2.2.1.1.6 A Covenant Not to Sue or Similarly Binding Representations Can Moot a Controversy Between the Parties

A party’s issuing a covenant not to sue or making a similarly binding representation such that it could not reasonably be expected to resume its enforcement efforts against a declaratory judgment plaintiff renders the case moot. *See Already, LLC v. Nike, Inc.*, 133 S. Ct. 721, 725 (2013) (trademark case); *Organic Seed Growers & Trade Ass’n v. Monsanto Co.*, 718 F.3d 1350, 1358 (Fed. Cir. 2013) (applying *Nike* to hold that Monsanto’s judicially binding representations that it had no intent to enforce its patents against the declaratory judgment appellants mooted the case); *Danisco U.S. Inc. v. Novozymes A/S*, 744 F.3d 1325 (Fed. Cir. 2014) (citing *Nike* and noting that Novozymes had failed to offer “any assurance, such as with a covenant not to sue, that it will not accuse Danisco’s [rapid starch liquefaction] products of [patent] infringement, which could potentially moot a controversy between the parties.”).

2.2.1.1.7 Dismissal Based on Meritorious Standing Motions

If a case must be dismissed for lack of standing, it should ordinarily be dismissed without prejudice. *See Propat Int’l Corp. v. RPost US, Inc.*, 473 F.3d 1187, 1194 (Fed. Cir. 2007) (affirming district court’s dismissal without prejudice even where non-exclusive licensee could not cure a standing defect by joining patent holder). If a plaintiff lacks standing, the court’s jurisdiction cannot be invoked, and the plaintiff should not be penalized if it subsequently corrects the standing defect, for example, by joining all co-owners of the patent rights. Nonetheless, where the basis for dismissal cannot be rectified, such as where a covenant not to sue moots the controversy, *see* § 2.2.1.1.6, then the dismissal should be with prejudice.

2.2.1.2 Declaratory Judgment Plaintiff

A district court has subject-matter jurisdiction over a patent declaratory judgment action when an “actual controversy” exists between the plaintiff and defendant. *See* 28 U.S.C. § 2201(a) (“In a case of actual controversy within its jurisdiction . . . any court of the United States, upon the filing of an appropriate pleading, may declare the rights and other legal relations of any interested party seeking such declaration, whether or not further relief is or could be sought.”). Where the patentee files for infringement, the defendant’s answer will almost always plead a counterclaim for a declaration of noninfringement, invalidity, and sometimes unenforceability. This apparently superfluous pleading preserves the defendant’s right to secure adjudication of claims that a plaintiff may later want to abandon for tactical reasons. For example, a plaintiff may decide to abandon claims in one asserted patent because the defendant raises strong invalidity defenses against that patent. A defendant’s de-

claratory judgment counterclaim maintains its ability to adjudicate the patent's validity and avoid being threatened by that patent again. Although a plaintiff cannot avoid declaratory judgment counterclaims by dismissing its affirmative claims on the patent(s), a patentee can divest the district court of subject-matter jurisdiction of declaratory judgment counterclaims by offering the declaratory judgment plaintiff a covenant not to sue on the patent(s). See *Dow Jones & Co., Inc. v. Ablaise Ltd.*, 606 F.3d 1388 (Fed. Cir. 2010); see also *Already, LLC v. Nike, Inc.*, 133 S. Ct. 721 (2013) (upholding the voluntary cessation doctrine).

Timing is key. If a covenant not to sue is given prior to consideration or resolution of the underlying infringement claim, for example, at the outset of the litigation, it may be effective. See *Benitec Austl., Ltd. v. Nucleonics, Inc.*, 495 F.3d 1340, 1347 (Fed. Cir. 2007). A covenant not to sue will not result in dismissal if given after the resolution of the infringement claims. *Fort James Corp. v. Solo Cup Co.*, 412 F.3d 1340, 1348 (Fed. Cir. 2005).

Declaratory judgment actions may also arise where the accused infringer (as the plaintiff) disputes the patentee's extrajudicial assertion of infringement and seeks judicial resolution of the issue. These cases typically arise when the patent holder has sent a letter or otherwise given notice suggesting that the potential infringer may want to license the patent. Although patent holders attempt to craft letters with ambiguous language that avoids provoking declaratory judgment jurisdiction, there is no "safe harbor" form of notice. See, e.g., *Hewlett-Packard Co. v. Acceleron LLC*, 587 F.3d 1358, 1362 (Fed. Cir. 2009) ("The purpose of a declaratory judgment action cannot be defeated simply by the stratagem of a correspondence that avoids the magic words such as 'litigation' or 'infringement.'"). Frequently, the patent holder will respond to a declaratory judgment action by immediately filing an infringement complaint in another jurisdiction. These disputes will usually be controlled by the "first filed" rule and its exceptions, which aim to prevent forum-shopping. At least one district court has found an infringement lawsuit filed on a U.S. patent in a foreign country (Dubai) sufficient to create subject-matter jurisdiction for a declaratory judgment action in the United States. See *Juniper Networks Inc. v. Bahattab*, 2009 U.S. Dist. LEXIS 129765, No. 07cv1771 (PLF) (AK) (D.D.C. Aug. 14, 2009) (noting that the patent owner's action in Dubai appeared to be a novel forum-shopping attempt).

The Supreme Court has acknowledged that its precedent "do[es] not draw the brightest of lines between those declaratory judgment actions that satisfy the case-or-controversy requirement and those that do not." *MedImmune, Inc. v. Genentech, Inc.*, 549 U.S. 118, 127 (2007). The Court explained: "Basically, the question in each case is whether the facts alleged, under all the circumstances, show that there is a substantial controversy, between parties having adverse legal interests, of sufficient immediacy and reality to warrant the issuance of a declaratory judgment." *Id.* (quoting *Md. Cas. Co. v. Pac. Coal & Oil Co.*, 312 U.S. 270, 273 (1941)). The Supreme Court rejected the "reasonable apprehension of suit" test, holding merely that "the dispute be 'definite and concrete, touching the legal relations having adverse legal interests'; and that it be 'real and substantial' and 'admi[t] of specific relief through a decree of a conclusive character, as distinguished from an opinion advising what the

law would be upon a hypothetical state of facts.” *Id.* at 132 n.11 (quoting *Aetna Life Ins. Co. v. Haworth*, 300 U.S. 227, 240 (1937)) (alteration in original).

Interpreting *MedImmune*, the Federal Circuit held that declaratory judgment jurisdiction exists whenever “a patentee asserts rights under a patent based on certain identified ongoing or planned activity of another party, and where that party contends that it has the right to engage in the accused activity without license.” *SanDisk Corp. v. STMicroelectronics, Inc.*, 480 F.3d 1372, 1381 (Fed. Cir. 2007); *see also Micron Tech., Inc. v. Mosaid Techs., Inc.*, 518 F.3d 897, 903 (Fed. Cir. 2008) (applying *MedImmune* and discussing the first-filed rule).

In *Arkema Inc. v. Honeywell International Inc.*, the Federal Circuit addressed the question of how far in advance the “planned activity” could occur to support declaratory judgment jurisdiction. 706 F.3d 1351 (Fed. Cir. 2013). Arkema intended to enter into long-term contracts to supply a product to be used in an alleged infringement. *Id.* at 1359. The commercial launch of the product in the United States was at least one year away, yet the Federal Circuit held that, under all the circumstances, Arkema was “in a *present* position of either committing to contracts that could expose it to liability for indirect infringement or abandoning its plans to supply [products] in the United States.” *Id.* at 1359. Thus, the dispute was “of sufficient immediacy and reality to warrant the issuance of a declaratory judgment.” *Id.* at 1360.

Another category of declaratory judgment actions is one in which a supplier files suit against a patentee who has sued (or threatened to sue) the supplier’s customers based on the supplier’s products or services. *See, e.g., Complaint for Declaratory Judgment, Cisco Sys., Inc. v. Innovative Wireless Sols., LLC*, Case 1:13-cv-00492, 2013 WL 3130645 (W.D. Tex. June 12, 2013). These actions are often accompanied by a request to stay the customer suits in favor of the supplier’s suit.

2.2.1.2.1 Defendant’s Declaratory Judgment Counterclaims Are Not Mooted by Dismissal of Plaintiff’s Infringement Claims

Accused infringers often file counterclaims for a declaratory judgment of invalidity as well as noninfringement. The Supreme Court has held that appellate affirmance of a judgment of noninfringement does not moot a declaratory judgment counterclaim of patent invalidity. *Cardinal Chem. Co. v. Morton Int’l, Inc.*, 508 U.S. 83, 98 (1993). In so holding, the Court again emphasized the importance to the public at large of resolving questions of patent validity, citing its opinion in *Blonder-Tongue Laboratories, Inc. v. University of Illinois Foundation*, 402 U.S. 313 (1971), and warned against “the danger that the opportunity to relitigate might, as a practical matter, grant monopoly privileges to the holders of invalid patents.” *Cardinal Chem.*, 508 U.S. at 101. However, a district court in the exercise of its discretion may decline to resolve a declaratory claim of invalidity following its adjudication of noninfringement. *See MedImmune, Inc. v. Genentech, Inc.*, 549 U.S. 118, 136 (2007) (noting that the Declaratory Judgment Act, which provides that a court “may declare the rights and other legal relations of any interested party,” 28 U.S.C. § 2201(a), “has long been understood ‘to confer on federal courts unique and substantial discretion

in deciding whether to declare the rights of litigants” (quoting *Wilton v. Seven Falls Co.*, 515 U.S. 277, 286 (1995)).

2.2.1.2.2 Assignor Is Estopped from Seeking Declaratory Judgment of Invalidity

An inventor who assigns his patent rights to an employer and then leaves to join a competing company may find himself sued for infringement. Under the equitable doctrine of assignor estoppel, the former employee is estopped from raising invalidity as a defense or as the basis of a declaratory judgment claim. *Pandrol USA, LP v. Airboss Ry. Prods., Inc.*, 424 F.3d 1161, 1166–67 (Fed. Cir. 2005); *Diamond Sci. Co. v. Ambico, Inc.*, 848 F.2d 1220, 1224 (Fed. Cir. 1988). The underlying policy is that “an assignor should not be permitted to sell something and later assert that what was sold is worthless, all to the detriment of the assignee.” *Pandrol*, 424 F.3d at 1167 (quoting *Diamond*, 848 F.2d at 1224).

The doctrine of assignor estoppel only applies to the defense in a patent infringement lawsuit and is not a separate federal cause of action. In *Semiconductor Energy Laboratory Co. v. Nagata*, the Federal Circuit rejected federal question jurisdiction over a case brought by a patent owner against the patent inventor. 706 F.3d 1365, 1368, 1370 (Fed. Cir. 2013). In an earlier infringement case brought by the patent owner, the inventor agreed to assist one of the defendants, and repudiated his signature on the patent application’s declaration and assignment, in alleged violation of an alleged duty not to contend the patent he assigned was invalid or unenforceable. *Id.* at 1370. After the earlier case settled, the patent owner sued the inventor for various state-law causes of action and a declaratory judgment of “violation of federal patent law” premised on the offensive application of the doctrine of assignor estoppel. *Id.* at 1368. The Federal Circuit affirmed the district court’s dismissal of the case for lack of federal question jurisdiction, holding that assignor estoppel “is a shield; it is an affirmative defense, not a claim for relief on its own,” and that the state-law claims accordingly did not present a substantial question of federal patent law. *Id.* at 1370–71.

2.2.1.2.2.1 Parties in Privity with Assignor Are Also Estopped

Because assignor estoppel is an equitable doctrine “mainly concerned with the balance of the equities between the parties[,] [t]hose in privity with the assignor partake of that balance, hence, extension of the estoppel to those in privity is justified.” *Intel Corp. v. U.S. Int’l Trade Comm’n*, 946 F.2d 821, 837 (Fed. Cir. 1991) (quoting *Shamrock Techs., Inc. v. Med. Sterilization, Inc.*, 903 F.2d 789, 793 (Fed. Cir. 1990)). Thus, the assignor’s subsequent employer may also be estopped from asserting that the assigned patent is invalid. *Id.*; *Mentor Graphics Corp. v. Quickturn Design Sys.*, 150 F.3d 1374, 1379 (Fed. Cir. 1998) (“Assignor estoppel also prevents parties in privity with an estopped assignor from challenging the validity of the patent.”).

In determining whether there is privity, the court should consider all contacts between the assignor and the alleged infringer, both direct and indirect, including

the relationship between those contacts and the alleged infringement. *Intel Corp.*, 946 F.2d at 839.

Privity, like the doctrine of assignor estoppel itself, is determined upon a balance of the equities. If an inventor assigns his invention to his employer company A and leaves to join company B, whether B is in privity and thus bound by the doctrine will depend on the equities dictated by the relationship between the inventor and company B in light of the act of infringement. The closer that relationship, the more the equities will favor applying the doctrine to company B.

Id. at 839–40 (quoting *Shamrock Techs.*, 903 F.2d at 793); *see also Checkpoint Sys. v. All-Tag Sec. S.A.*, 412 F.3d 1331, 1337 (Fed. Cir. 2005) (“Privity may be established where there is a close relationship among the relevant parties, such as where the ultimate infringer availed itself of the inventor’s knowledge and assistance to conduct infringement.”). Factors considered by other courts in assessing privity include: (1) the extent and nature of the parties’ business relationships (e.g., whether a party challenging validity formed a joint venture with the assignor to manufacture the infringing product or whether a party challenging validity is a subsidiary of the assignor), (2) the financial dealings between the parties, including whether there is an indemnification agreement between the alleged infringer and the assignor, and (3) whether the ultimate infringer availed itself of the inventor’s “knowledge and assistance” to conduct infringement. *Id.* (citing cases); *Checkpoint*, 412 F.3d at 1337; *Mentor Graphics*, 150 F.3d at 1379; *Dane Indus. v. Ameritek Indus., LLC*, 154 F. App’x 894 (Fed. Cir. 2005) (unpublished opinion).

2.2.1.2.3 Actual Case or Controversy Can Exist for Licensee in Good Standing Even in Absence of Material Breach

Patent licensees who are performing under their license agreement (e.g., paying royalties) may nevertheless present a controversy with their licensor sufficient to support a declaratory judgment action. This has not always been the case. Historically, courts held that patent licensees in good standing were unable to sue for a declaratory judgment that the licensed patent is invalid because (1) the licensee was not threatened with imminent injury and, therefore, had no standing and (2) no actual case or controversy existed so long as the license agreement was not breached. *See, e.g., Gen-Probe Inc. v. Vysis, Inc.*, 359 F.3d 1376, 1381 (Fed. Cir. 2004). The Supreme Court reversed this line of cases in 2007, holding that a patent licensee need not break or terminate its license agreement before seeking a declaratory judgment in federal court that the underlying patent is invalid, unenforceable, or not infringed. *MedImmune, Inc. v. Genentech, Inc.*, 549 U.S. 118, 136–37 (2007).

2.2.2 Defendant Standing Requirements

2.2.2.1 Infringement Defendants

A patent holder is not obligated to sue all accused infringers. It can select from alleged infringers—both direct and indirect. *See Giese v. Pierce Chem. Co.*, 29 F.

Supp. 2d 33, 40 (D. Mass. 1998) (“Courts have generally held that a patentee need not sue more than one infringer at a given time.”) (quoting *Watkins v. Nw. Ohio Tractor Pullers Ass’n, Inc.*, 630 F.2d 1155, 1162 (6th Cir. 1980)).

While proof of direct infringement is a predicate to proving induced or contributory infringement, *Joy Techs., Inc. v. Flakt, Inc.*, 6 F.3d 770, 774 (Fed. Cir. 1993) (collecting cases), direct infringers do not have to be joined in a suit against a contributory infringer. *Refac Int’l, Ltd. v. IBM*, 790 F.2d 79, 81 (Fed. Cir. 1986) (“direct infringers need not be parties”); see also *Upjohn Co. v. Syntro Corp.*, 1990 U.S. Dist. LEXIS 11512, 1990 WL 79232 (D. Del. 1990).

2.2.2.1.1 Joinder Issues

Prior to the enactment of the America Invents Act (AIA) on September 16, 2011, Federal Rule of Civil Procedure 20(a)(2) governed the joinder of unrelated defendants in the same patent action. In some cases, the accused products differed drastically from one defendant to another, which could lead to many distinct theories of infringement. These cases commonly proceeded without severance or were consolidated on the theory that judicial resources would be conserved because the asserted patent was common to all the defendants. See, e.g., *MyMail Ltd. v. AOL, Inc.*, 223 F.R.D. 455, 456 (E.D. Tex. 2004) (reasoning that the “same transaction or occurrence” requires only “some connection or logical relationship between the various transactions or occurrences”). Although some issues, such as those relating to patent validity, would be the same for all of the defendants, the complexities in case management and discovery prompted some courts to reconsider this approach. See *Bender v. Exar Corp.*, CV 09-01140 (N.D. Cal. Aug. 3, 2009) (Alsup, J.) (refusing to relate twenty-four patent cases asserting the same patent); *Man Mach. Interface Techs., LLC v. Funai Corp., et al.*, CV 10-8629 (C.D. Cal. Apr. 7, 2011) (Walter, J.) (dismissing a defendant as improperly joined); *Interval Licensing LLC v. AOL, Inc.*, 2011 U.S. Dist. LEXIS 51195, 2011 WL 1655713 (W.D. Wash. Apr. 29, 2011) (holding that joinder was improper because “[p]laintiff has not alleged that the Defendants have engaged in the same transaction or occurrence”). In *In re EMC Corp. (In re EMC I)*, 677 F.3d 1351, 1356 (Fed. Cir. 2012), the Federal Circuit clarified the law of joinder, holding that joinder is not appropriate merely because defendants face identical infringement claims or where different products or processes are involved. Instead, there must be “shared, overlapping facts that give rise to each cause of action, and not just distinct, albeit coincidentally identical, facts.” *Id.* at 1359. “Unless there is an actual link between the facts underlying each claim of infringement, independently developed products using differently sourced parts are not part of the same transaction, even if they are otherwise coincidentally identical.” *Id.*

Responding to concerns about joinder practices in patent cases, Congress enacted a special rule narrowing the joinder standards for patent cases in the AIA. Section 299 (a)(1) states that accused infringers may be joined only if

any right to relief is asserted against the parties jointly, severally, or in the alternative with respect to or arising out of the same transaction, occurrence, or series of transactions or occurrences relating to the making, using, importing into the United States,

offering for sale, or selling of the same accused product or processes; and (2) questions of fact common to all defendants or counterclaim defendants will arise in the action.

Notably, the AIA specifically states that common infringement of the same patent, without more, is not enough to justify joinder in the same action. *See* § 299(b). The legislative history of the provision indicates that Congress intended to abrogate the interpretation of Federal Rule of Civil Procedure 20(a) adopted in *MyMail v. AOL* by more narrowly defining the parties who are properly joined in the same action for patent infringement. *See* H.R. Rep. 112-98 (2011). Note that § 299(c) provides that accused infringers may consent to joinder. Furthermore, the AIA's joinder rule does not stand in the way of consolidation of pretrial proceedings pursuant to 28 U.S.C. § 1407. *See* § 2.3.4.

Since the AIA joinder provision went into effect, several courts have held that joinder is proper where multiple alleged infringers of the same patent also share the same underlying accused product. *See, e.g., Vertical Comput. Sys., Inc. v. LG Elecs. MobileComm U.S.A., Inc.*, 2013 U.S. Dist. LEXIS 71561, 2013 WL 2241947 (E.D. Tex. May 21, 2013) (finding different defendants' common usage of Google's Android OS satisfied the "actual link" requirement in *In re EMC I*); *Steuben Foods, Inc. v. Oystar Grp.*, 2013 U.S. Dist. LEXIS 187536, 2013 WL 2105894, at *7 (W.D.N.Y. May 14, 2013) (denying motion to sever one defendant and transfer the infringement claims against it to a different forum, where the infringement claims against all the named defendants appeared to be based on the same accused product).

That said, "even if a plaintiff's claims arise out of the same transaction and there are questions of law and fact common to all defendants, district courts have the discretion to refuse joinder in the interest of avoiding prejudice and delay, ensuring judicial economy, or safeguarding principles of fundamental fairness." *In re EMC I*, 677 F.3d at 1360 (quoting *Acevedo v. Allsup's Convenience Stores, Inc.*, 600 F.3d 516, 521 (5th Cir. 2010)). "In a complicated patent litigation a large number of defendants might prove unwieldy, and a district court would be justified in exercising its discretion to deny joinder when different witnesses and documentary proof would be required." *Id.* (citations omitted). Because of § 299, some courts have denied joinder and severed defendants from the case, even where all defendants are accused of infringing the same product. *See Digitech Image Techs., LLC v. Agfaphoto Holding GmbH*, 2012 U.S. Dist. LEXIS 142034, 2012 WL 4513805 (C.D. Cal. Oct. 1, 2012) (severing forty-four defendants from the case because the relief sought did not arise out of the "same transaction" as required by § 299). While the AIA makes it easier for patent infringement defendants to challenge joinder, it has also led to a significant increase in "serially filed" cases that burden courts' dockets.

Even where the AIA's misjoinder provision bars formal joinder, some district courts have effectively consolidated serially filed cases involving the same patent or patents for claim construction. *See* § 5.1.3.8. Such treatment preserves the right of defendants to be tried separately while economizing on judicial and the parties' resources. Nonetheless, courts should be sensitive to the adverse effects on the parties of such effective consolidation of some pretrial issues. *See* § 5.1.3.8 (discussing effects on transfer motions). For example, a plaintiff could file a series of lawsuits timed to avoid having to meet substantive deadlines; when a deadline approaches, a new case

could be filed along with a request to consolidate the cases and reschedule deadlines. This could disadvantage the first defendants in the series relative to the plaintiff and later defendants.

2.2.2.2 Declaratory Judgment Defendants

A declaratory judgment action seeking to invalidate or render unenforceable a patent must name as defendants all parties holding an interest in the patent. However, nonexclusive licensees are generally not thought to be necessary parties. See *In-Tech Mktg. Inc. v. Hasbro, Inc.*, 685 F. Supp. 436, 438–41 (D.N.J. 1988) (holding that a purported exclusive licensee was not a necessary party); *Meese v. Eaton Mfg. Co.*, 35 F.R.D. 162, 166–67 (N.D. Ohio 1964) (stating that, notwithstanding *Independent Wireless*, “[c]ourts have generally agreed that a mere licensee is not indispensable to an infringement suit by the patentholder”); cf. *Indep. Wireless*, 269 U.S. at 466 (describing a licensor and an exclusive licensee as “generally necessary parties in the action in equity”); *Arey v. Goodyear Tire & Rubber Co.*, 11 F.R.D. 209, 209 (N.D. Ohio 1951) (stating that an exclusive licensee was both necessary and indispensable).

2.2.3 Pleading

2.2.3.1 Infringement

Infringement complaints are usually sparse and conclusory. Typically, a patent holder will merely allege that a defendant is directly or indirectly infringing a patent. The asserted patents must be identified, and are often attached to the complaint. Some local rules require that they be attached. The complaint should also provide a statement of ownership of the asserted patent(s), identify the accused infringer(s), provide a brief statement of alleged infringing acts, and (if applicable) a statement regarding the patent owner’s marking of a product with the patent number under § 287.

Historically, under the notice pleading requirement of Federal Rule of Civil Procedure 8(a), the patent holder has not been required to do more. Therefore, a defendant would not know which claims of the patents are being asserted against it and sometimes would not even know which of its products or processes are accused of infringing.

Past practices in pleading infringement, exemplified by Form 18, arguably conflict with recent Supreme Court precedent requiring greater specificity in complaints. In *Bell Atlantic Corp. v. Twombly*, an antitrust case, the Court held that “a plaintiff’s obligation to provide the ‘grounds’ of his ‘entitle[ment] to relief’ requires more than labels and conclusions, and a formulaic recitation of the elements of a cause of action will not do.” 550 U.S. 544, 555 (2007) (internal citations omitted). Even after *Twombly*, however, the Federal Circuit held that “a patentee need only plead facts sufficient to place the alleged infringer on notice as to what he must defend [A patentee] is not required to specifically include each element of the claims of the asserted patent.” *McZeal v. Sprint Nextel Corp.*, 501 F.3d 1354, 1357

(Fed. Cir. 2007) (vacating dismissal of *pro se* plaintiff's complaint that conformed to Form 18 (then Form 16)). In 2009, the Supreme Court again addressed Rule 8(a), when it clarified that the holding of *Twombly* was not limited to antitrust cases. The Court held that “[t]o survive a motion to dismiss, a complaint must contain sufficient factual matter, accepted as true, to ‘state a claim to relief that is plausible on its face.’” *Ashcroft v. Iqbal*, 556 U.S. 662, 678 (2009) (quoting *Twombly*, 550 U.S. at 555). “Where a complaint pleads facts that are ‘merely consistent with’ a defendant’s liability, it ‘stops short of the line between possibility and plausibility of ‘entitlement to relief.’” *Id.* (quoting *Twombly*, 550 U.S. at 557).

Despite the Supreme Court’s reiteration of heightened pleading standards, the Federal Circuit has so far held to its position that Form 18 controls the pleading requirements for direct patent infringement. See *In re Bill of Lading Transmission & Processing Sys. Patent Litig.*, 681 F.3d 1323 (Fed. Cir. 2012); see also *K-Tech Telecomms., Inc. v. Time Warner Cable, Inc.*, 714 F.3d 1277, 1283 (Fed. Cir. 2013) (“as we made clear in *R+L Carriers*, to the extent any conflict exists between *Twombly* (and its progeny) and the Forms regarding pleadings requirements, the Forms control”). In fact, the Federal Circuit does not even require the complaint to identify a specific accused product as long as it conforms to Form 18 and Rule 8(a). *K-Tech*, 714 F.3d at 1286.

District courts have struggled to reconcile Form 18 and Rule 84 with *Iqbal* and *Twombly*. Some courts have concluded that Form 18 applies only to claims of direct infringement, but that for claims of indirect infringement, more detailed allegations are required, such as the identity of the underlying direct infringer and the facts supporting the knowledge element of indirect infringement. See, e.g., *Elan Microelectronics Corp. v. Apple, Inc.*, 2009 U.S. Dist. LEXIS 83715, 2009 WL 2972374 (N.D. Cal. Sept. 14, 2009) (recognizing that Form 18 provides an example of how direct, but not indirect, patent infringement may be alleged); *Eolas Techs. Inc. v. Adobe Sys. Inc.*, 2010 U.S. Dist. LEXIS 58291, 2010 WL 2026627, at *3 (E.D. Tex. May 6, 2010) (“Form 18 does not expressly address indirect infringement claims, and courts are split on the pleading requirements of indirect infringement.”). The Federal Circuit concurs: “In other words, because Form 18 addresses only direct infringement, we must look to Supreme Court precedent for guidance regarding the pleading requirements for claims of indirect infringement.” *In re Bill of Lading*, 681 F.3d at 1337.

Aside from willful infringement, see § 2.2.3.2, defendants have increasingly challenged the sufficiency of allegations of induced and contributory infringement, particularly with respect to the specific intent requirement of induced infringement. Courts have generally required factual allegations not only of a defendant’s knowledge of a plaintiff’s patent at the time of the infringement, but also that the defendant knew the use of its product constituted infringement. See, e.g., *Versata Software, Inc. v. Cloud9 Analytics, Inc.*, 2014 U.S. Dist. LEXIS 19994, 2014 WL 631517, at *2 (D. Del. Feb. 18, 2014). However, there is not yet a consensus on whether the filing of the complaint is alone sufficient to satisfy the knowledge requirement of induced infringement. Compare *Bascom Research LLC v. Facebook, Inc.*, 2013 U.S. Dist. LEXIS 41429, 2013 WL 968210, at *4 (N.D. Cal. Mar. 12, 2013)

(filing of the complaint held sufficient to establish defendant's postsuit knowledge for purpose of induced infringement, but that infringement was limited to postfiling conduct) *with Mallinckrodt Inc. v. E-Z-EM Inc.*, 670 F. Supp. 2d 349, 354 (D. Del. 2009) ("The Court is not persuaded by Plaintiffs' contention that the requisite knowledge [for induced infringement claim] can be established by the filing of the Plaintiffs' Complaint.").

Some courts require that pleadings identify which of a defendant's specific products or practices allegedly infringe. *See, e.g., Interval Licensing LLC v. AOL, Inc.*, No. 2010 U.S. Dist. LEXIS 131081, 2010 WL 5058620 (W.D. Wash. Dec. 10, 2010); *Bender v. LG Elecs., U.S.A., Inc.*, 2010 U.S. Dist. LEXIS 33075, 2010 WL 889541 (N.D. Cal. Mar. 11, 2010). In some cases, however, discovery may be necessary to identify how a defendant's product works and whether it infringes. Rule 11(b)(3) allows allegations that "will likely have evidentiary support after a reasonable opportunity for . . . discovery," but at least one district court has held that Rule 11(b)(3) does not affect the pleading standard under Rule 8(a). *Elan*, 2009 WL 2972374, at *3.

Despite Federal Circuit decisions upholding pleadings conforming to Form 18, some district courts continue to challenge the sufficiency of Form 18 and have required the heightened pleading standards set forth by the Supreme Court, even in cases of direct patent infringement. *See Macronix Int'l Co. v. Spansion Inc.*, 4 F. Supp. 3d 797 (E.D. Va. 2014) (holding that patent complaints are subject to the heightened pleading standard set forth in *Twombly* and *Iqbal*); *see also Regeneron Pharm., Inc. v. Merus B.V.*, 2014 U.S. Dist. LEXIS 84297, 2014 WL 2795461 (S.D.N.Y. June 19, 2014) ("This Court finds that the Federal Circuit's determination that *Twombly* is inapplicable to patent cases conflicts with significant Second Circuit precedent applying the principles of *Twombly* at the pleading stage of civil cases. This Court has found no basis in Second Circuit precedent to treat patent cases differently from other cases in which forms exist and to which *Twombly* applies. The principles set forth in *Twombly* apply to the evaluation of pleadings in patent infringement cases in this Circuit. Thus, the sufficiency of Regeneron's claim for patent infringement is assessed pursuant to the basic elements set forth in Form 18 as well as the guidance provided in *Twombly*.").

Other courts disagree with these challenges and question how the Federal Circuit's clear stance on Form 18 can be distinguished. *See JDS Uniphase Corp. v. Co-Adna Photonics, Inc.*, 2014 U.S. Dist. LEXIS 88031, 2014 WL 2918544 (N.D. Cal. June 26, 2014) ("As for *Macronix*, that opinion forcefully disagrees that *Bill of Lading* and *McZeal*, correctly applied the Supreme Court's decisions in *Twombly* and *Iqbal*. This court is unpersuaded by the opinion in *Macronix*, since it provides no argument for how *K-Tech*, which again reinforced the Federal Circuit's understanding of Form 18, can be distinguished. To the extent *K-Tech's* analysis rested on 'the applicable law of the regional circuit,' it was also applying the controlling law of the Ninth Circuit that this court is also bound to apply.") (citations omitted).

On December 1, 2015, the U.S. Supreme Court adopted a number of amendments to the Federal Rules of Civil Procedure. Among these is the abolition of Rule 84 and the Appendix of Forms, including Form 18. As a result, the pleading standards set forth in *Twombly* and *Iqbal* govern patent complaints.

Aside from heightened pleading requirements, some local rules require disclosure of additional information early in the case. *See, e.g.*, N.D. Cal. Patent L.R. 3-1 (requiring early disclosure of asserted claims and accused products). After that early disclosure, the asserted claims and accused products may not be amended without leave of court for good cause. *See* N.D. Cal. Patent L.R. 3-6. A plaintiff's diligence in investigating accused products may demonstrate good cause. *See O2 Micro*, 467 F.3d at 1366; *Abbott Diabetes Care Inc. v. Roche Diagnostics Corp.*, 2007 WL 2221029, 2007 U.S. Dist. LEXIS 59161, at *5-6 (N.D. Cal. July 30, 2007).

Courts also consider procedural matters in assessing good cause, including the impact of amendment on other case deadlines, whether the opponent already had sufficient notice of the added contentions, and whether there is prejudice or whether any prejudice may be mitigated through an award of costs. *Avago Techs. Gen. IP PTE Ltd. v. Elan Microelectronics Corp.*, No. C04-05385 JW (HRL), 2007 WL 1449758, 2007 U.S. Dist. LEXIS 39543, at *4 (N.D. Cal. May 15, 2007) (citing cases); *3COM Corp v. D-Link Sys., Inc.*, No. C 03-2177 VRW, 2007 WL 949596, 2007 U.S. Dist. LEXIS 26542, at *21-22 (N.D. Cal. Mar. 27, 2007) (finding good cause where amendment would occur before a *Markman* hearing and before the close of discovery; “[i]t is to be expected that a patent holder may find other product designations that infringe as discovery progresses”). Indeed, a decision on good cause may hinge on the timing of the amendments sought. *Compare Gen. Atomics v. Axis-Shield ASA*, No. C 05-04074 SI, 2006 WL 2329464, 2006 U.S. Dist. LEXIS 58939, at *5-6 (N.D. Cal. Aug. 9, 2006) (finding good cause where party “did not conceive of the infringement theory it seeks to add until the parties exchanged preliminary claim construction statements” and noting that the amendments were sought before claim construction) *with Atmel Corp. v. Info. Storage Devices Inc.*, No. C 95-1987 FMS, 1998 WL 775115, 1998 U.S. Dist. LEXIS 17564, at *5-9 (N.D. Cal. Nov. 5, 1998) (denying leave to amend based on “newly discovered facts” where claim construction was completed and summary judgment briefing had begun).

2.2.3.2 Willful Infringement

Like general infringement, willful infringement need not be pleaded with particularity. Nonetheless, some courts require greater specificity with regard to the advice of counsel defense that is often interposed in response to an allegation of willful infringement.

2.2.3.2.1 Opinions of Counsel

Defendants sometimes rely on opinions of counsel as part of a defense to an allegation of willful infringement—that is, a patent attorney’s opinion as to whether the asserted patent is valid and/or infringed by the defendant’s products or processes. A defendant need not plead in its answer that it will be relying on an opinion of counsel. However, in the interests of fair and efficient discovery, some courts require election of the advice-of-counsel defense by a specified date along with production of the attorney–client documents for which protection has been waived. *See, e.g.*, N.D. Cal. Patent L.R. 3-7.

2.2.3.2.2 Privilege Issues Relating to Opinions of Counsel

Where a party relies on an opinion of counsel, it waives privilege as to the opinion. *In re EchoStar Commc'ns Corp.*, 448 F.3d 1294, 1299 (Fed. Cir. 2006); *Informati-ca Corp. v. Bus. Objects Data Integration, Inc.*, No. C 02-3378 JSW, 2006 U.S. Dist. LEXIS 58976, at *5, 2006 WL 2329460 (N.D. Cal. Aug. 9, 2006).

The scope of that waiver is a knotty problem that often becomes the subject of motion practice. The problem is exacerbated when litigation counsel also gave the opinion. *Genentech, Inc. v. Insmed Inc.*, 442 F. Supp. 2d 838, 842–44 (N.D. Cal. 2006). Federal Circuit law is used to analyze the scope of the waiver in these cases. *EchoStar*, 448 F.3d at 1298. Waiver extends not only to opinions on which the party intends to rely but also to all related communications and documents relied on or considered in connection with the opinion. *Id.* at 1304.

The Federal Circuit clarified the scope of privilege waiver in *In re Seagate Tech., LLC*, 497 F.3d 1360 (Fed. Cir. 2007) (en banc), *overruled on other grounds by Halo Elecs., Inc. v. Pulse Elecs., Inc.*, 579 U.S. ____ (2016). The court found that the “significantly different functions of trial counsel and opinion counsel advise against extending waiver to trial counsel.” *Id.* at 1373. The classic “sword and shield” argument does not apply, because of the very different types of legal advice offered by trial counsel (litigation strategy and adversarial representation) and opinion counsel (commercial “due care” taken before undertaking potentially infringing activity).⁸ *Id.* at 1372–75. The same rationale applies to the work-product doctrine. *Id.* at 1375–76 (applying *Hickman v. Taylor*, 329 U.S. 495, 510–11 (1947), and *United States v. Nobles*, 422 U.S. 225, 239–40 (1975)).

Although *Seagate* provides courts with substantial guidance, they must continue to be attentive, in summary judgment practice and at trial, to attempts by a party to use evidence it previously argued was outside the scope of the waiver, particularly as the law in this area continues to evolve. The standard for determining willfulness remains the totality of the circumstances. *Halo Elecs., Inc. v. Pulse Elecs., Inc.*, 579 U.S. ____ (2016) (holding that “courts should continue to take into account the particular circumstances of each case in deciding whether to award [enhanced] damages, and in what amount”). Those circumstances, however, should not automatically include whether the accused infringer sought advice of counsel or presented it to the jury. Section 298, which was enacted as part of the America Invents Act in 2011, provides that “[t]he failure of an infringer to obtain the advice of counsel” or “the failure of the infringer to present such advice to the court or jury, may not be used to prove that the accused infringer willfully infringed” 35 U.S.C. § 298. Of course, defendants may waive the protection offered by Section 298 if they put reliance on advice of counsel at issue. *See, e.g., Ultratec Inc. v. Sorenson Commc'ns Inc.*, 2014 WL 4976596, at *1-2 (W.D. Wis. Oct. 3, 2014), amended, 2014 WL 5023098 (W.D. Wis. Oct. 8, 2014).

8. The Federal Circuit heavily discounted the value of post-litigation-commencement opinions for this same reason.

2.2.3.3 Defenses

2.2.3.3.1 Invalidity Defenses

Like plaintiffs' allegations of infringement, defendants' allegations of invalidity need not be pled with particularity. Defendants typically recite only that the patent is invalid, and may identify sections of the Patent Act, such as § 101, 102, 103, or 112. Although this sort of notice pleading has usually been held to satisfy the Federal Rules of Civil Procedure, in practice, it gives little notice to a patent holder about what grounds for invalidity a defendant will actually assert. For this reason, in a few instances, courts have applied *Twombly* and *Iqbal* to strike affirmative defenses and counterclaims for not providing sufficient detail in the pleadings. See *Cleversafe, Inc. v. Amplidata, Inc.* 2011 U.S. Dist. LEXIS 145995, 2011 WL 6379300 (N.D. Ill. Dec. 20, 2011) (dismissing affirmative defense of invalidity and counterclaim); *Groupon, Inc. v. MobGob LLC*, 2011 U.S. Dist. LEXIS 56937, 2011 WL 2111986 (N.D. Ill. May 25, 2011) (dismissing counterclaim); *Tyco Fire Prods. LP v. Victaulic Co.*, 777 F. Supp. 2d 921 (E.D. Pa. 2011) (dismissing counterclaim but not affirmative defense). But see *Pfizer v. Apotex, Inc.* 726 F. Supp. 921 (N.D. Ill. 2010) (notice of claim sufficient for invalidity counterclaim).

In addition, some district judges require that defendants disclose the specific grounds on which they assert invalidity early in a case, just as they require specific infringement contentions from a patent owner. Courts can require defendants to identify specific prior art references they intend to assert as invalidating and to disclose invalidity claims based on written description, indefiniteness, or enablement. See, e.g., N.D. Cal. Patent L.R. 3-3. Following a specified time period for making these disclosures, they may be amended only upon a showing of good cause. See N.D. Cal. Patent L.R. 3-7.

2.2.3.3.2 Unenforceability Defenses

Unenforceability defenses include inequitable conduct, prosecution laches, equitable estoppel, and patent misuse (e.g., using patent rights to force tying agreements or compulsory licensing packages). With the exception of inequitable conduct, unenforceability allegations need not be pled with particularity.

2.2.3.3.2.1 Inequitable Conduct Pled with Particularity

Inequitable conduct is seen as a species of fraud, and must be pled with particularity. Fed. R. Civ. P. 9(b). Inequitable conduct must rest on specific allegations of intentional, material omissions or misrepresentations by the patentee during the application process for a patent—the “who, what, when, where, and how” of the alleged inequitable conduct. *Exergen Corp. v. Wal-Mart Stores, Inc.*, 575 F.3d 1312, 1327 (Fed. Cir. 2009); see also *Ferguson Beauregard/Logic Controls, Inc. v. Mega Sys., LLC*, 350 F.3d 1327, 1344 (Fed. Cir. 2003). The necessary knowledge and intent may be pled generally or on information and belief, but there must be sufficient allegations of underlying facts from which a court could reasonably infer that a specific person had such knowledge and intent. *Exergen*, 575 F.3d at 1328–29. Early in the case, any

order granting dismissal for lack of specificity should be without prejudice. See *Sun Microsystems v. Dataram Corp.*, Civ. No. 96-20708 SW, 1997 WL 50272, 1997 U.S. Dist. LEXIS 4557, at *5–7, 12–14 (N.D. Cal. Feb. 4, 1997). Under recent Federal Circuit precedent, “[t]o prevail on the defense of inequitable conduct, the accused infringer must prove that the applicant misrepresented or omitted material information with the specific intent to deceive the PTO.” *Therasense, Inc. v. Becton, Dickinson & Co.*, 649 F.3d 1276, 1287 (Fed. Cir. 2011). Furthermore, to prevail under the current standard, the accuser must prove that “but for” the withholding of a reference, the patent would not have issued. *Id.* at 1291.

Because of the particularity requirement, defendants often seek leave to amend or to add inequitable conduct allegations as they are developed during discovery. Assuming the defense is pled with sufficient particularity, such motions should be granted if brought early in the case. *Id.* However, as the case approaches trial, the potential for prejudice to the patentee from late-arising claims increases. See, e.g., *Cent. Admixture Pharm. Servs. v. Advanced Cardiac Sols., P.C.*, 482 F.3d 1347, 1357 (Fed. Cir. 2007).

To forestall unnecessary motion practice on inequitable conduct claims, courts often set a cut-off date for pleading such allegations. Under this approach, prior to that date, a defendant may add inequitable conduct allegations without seeking leave of court. Thereafter, such allegations may only be added upon a showing of good cause for delay. A typical time frame for cut-off is when fact discovery is approximately 60% complete (e.g., if fact discovery is scheduled for a five-month period, the cut-off date for asserting inequitable conduct would be at three months).

2.2.3.3.2.2 Privilege Issues Relating to Unenforceability

Unenforceability allegations typically relate to the prosecution of the patent (inequitable conduct and prosecution laches) or to decisions relating to misuse of the patent, such as conditioning a license agreement on the requirement to buy non-patented products (i.e., improper tying schemes). These issues typically involve attorney–client communications and may also involve attorney work product. As a result, discovery may generate disputes over privilege. Attorney–client privilege doctrine applies in these matters as it applies generally. Therefore, absent a showing under the crime-fraud exception doctrine, *In re Rhone-Poulenc Rorer*, 48 U.S.P.Q.2D (BNA) 1823, 1998 U.S. App. LEXIS 12829 (Fed. Cir. 1998), the privilege may be asserted, even where it appears to obstruct fact gathering critical to prosecuting an unenforceability claim. *Id.*

2.2.4 Counterclaims

The defendant typically asserts an array of counterclaims. In nearly every case, it seeks a declaratory judgment that the asserted patents are not infringed, invalid, and/or unenforceable. The defendant may also assert infringement of its own patents in a counterclaim.

2.2.4.1 Compulsory Counterclaims

Under Federal Rule of Civil Procedure 13(a), a counterclaim is compulsory if it arises out of the same transaction or occurrence as the opposing party's claim. Unsurprisingly, a counterclaim for infringement is compulsory in an action for declaration of noninfringement. *Vivid Techs., Inc. v. Am. Sci. & Eng'g, Inc.*, 200 F.3d 795, 802 (Fed. Cir. 1999). Similarly, counterclaims for declaratory judgment of non-infringement or invalidity are compulsory with respect to a claim of infringement.

2.2.4.2 Noncompulsory Counterclaims

In the most common noncompulsory counterclaim in a patent suit, the defendant/accused infringer alleges infringement of defendant's patent(s) by the plaintiff. Other arguably noncompulsory counterclaims may include antitrust claims, *Walker Process* claims (that the patentee asserts a fraudulently procured patent), *Walker Process Equip., Inc. v. Food Mach. & Chem. Corp.*, 382 U.S. 172 (1965), or *Handgards* claims (that the patentee seeks to enforce a patent it knows to be invalid or not infringed), *Handgards, Inc. v. Ethicon, Inc.*, 601 F.2d 986 (9th Cir. 1979). See *Tank Insulation Int'l, Inc. v. Insultherm, Inc.*, 104 F.3d 83 (5th Cir. 1997); *Hydranautics v. FilmTec Corp.*, 70 F.3d 533, 536–37 (9th Cir. 1995). Some courts have held that antitrust claims based on allegations of patent invalidity are compulsory, rather than permissive. See *Critical-Vac Filtration Corp. v. Minuteman Int'l, Inc.*, 233 F.3d 697, 702 (2d Cir. 2000). The Federal Circuit has observed the split of authority but has not resolved it. See *Nobelpharma AB v. Implant Innovations, Inc.*, 141 F.3d 1059, 1067 n.4 (Fed. Cir. 1998).

2.2.5 Potential Overlap with Nonpatent Claims; Choice of Law

Patent complaints may overlap with other forms of federal intellectual property claims (e.g., copyright, trademark), antitrust and sham litigation claims, and state-law claims such as unfair competition, trade secret misappropriation, or breach of a patent license agreement. Federal Circuit law governs issues within its “exclusive jurisdiction” (i.e., patent law issues). See, e.g., *Advanced Cardiovascular Sys., Inc. v. Medtronic, Inc.*, 265 F.3d 1294, 1303 (Fed. Cir. 2001) (holding that the Federal Circuit will apply its “own law to both substantive and procedural issues intimately involved in the substance of enforcement of the patent right.”) (quotation omitted). The law of the regional circuit in which the district court sits governs issues outside of the Federal Circuit's exclusive jurisdiction. *Id.*

The question of whether federal patent law preempts other federal or state-law claims is decided based on Federal Circuit law, not regional circuit law. See *Midwest Indus., Inc. v. Karavan Trailers, Inc.*, 175 F.3d 1356, 1360–61 (Fed. Cir. 1999). But see *Gunn v. Minton*, 133 S. Ct. 1059 (2013) (applying *Grable & Sons Metal Prods., Inc. v. Darue Eng'g & Mfg.*, 545 U.S. 308, 314 (2005) to conclude “that state legal malprac-

tice claims based on underlying patent matters will rarely, if ever, arise under federal patent law for purposes of 28 U.S.C. § 1338(a)").

2.2.6 Interaction with Other Types of Actions

2.2.6.1 Bankruptcy

Typically, when a debtor begins bankruptcy proceedings, all pending actions against the debtor, including actions in federal district courts, are stayed. Section 362(a)(3) of the Bankruptcy Code provides that a petition "operates as a stay, applicable to all entities of . . . any act to obtain possession of property of the estate or of property from the estate or to exercise control over property of the estate." The stay applies to pending patent litigation against a debtor, but not to claims by the debtor. *See Seiko Epson Corp. v. Nu-Kote Int'l, Inc.*, 190 F.3d 1360, 1364 (Fed. Cir. 1999). Such claims may proceed (e.g., if the debtor is the accused infringer, the debtor's counterclaims for patent invalidity may proceed). *See id.* Likewise, the automatic stay does not apply to non-bankrupt codefendants of a debtor. *Id.*; *but see In re Excel Innovations, Inc.*, 502 F.3d 1086, 1093–94, n.1 (9th Cir. 2007) (holding that on motion by debtor, bankruptcy court may enjoin ongoing proceedings against non-debtor; in most circuits, standard analysis for granting preliminary injunctive relief applies; some circuits do not require showing of irreparable harm). The district court may stay the entire case once the bankruptcy court automatically stays the claims against the debtor. Alternatively, it may proceed with those aspects of the case that are not subject to the automatic stay.

A party may petition the bankruptcy court for partial or full relief from the stay. *See Outlast Techs., Inc. v. Frisby Techs., Inc.*, 298 F. Supp. 2d 1112, 1113–14 (D. Colo. 2004) (modifying stay order to allow summary judgment motions already filed in the district court to be decided). If a district court believes that such relief is appropriate, for example because trial has commenced or a decision on summary judgment is pending, it may suggest such a motion for relief in its order staying proceedings in response to the bankruptcy court's automatic stay notice.

The bankruptcy court's disposition of the debtor's bankruptcy does not give the debtor a license to commit postpetition infringement. "A discharge in bankruptcy operates as an injunction against a plaintiff asserting a claim for a debt incurred, or a cause of action that arose, before the date of bankruptcy discharge. It does not act as an injunction against a plaintiff asserting a claim for a debt incurred, or a cause of action that arose, after the date of bankruptcy discharge." *Hazelquist v. Guchi Moochie Tackle Co.*, 437 F.3d 1178, 1180 (Fed. Cir. 2006). Therefore, if an accused infringer continues infringement after discharge of debts in bankruptcy court, it is subject to renewed patent litigation in federal district court. *Id.*

2.2.6.2 International Trade Commission Actions

In parallel with the district courts, the United States International Trade Commission (ITC) provides a forum for domestic industries to seek exclusion of goods

that violate U.S. intellectual property rights. The ITC is an independent agency that, among other things, directs actions against unfair trade practices. Under § 337 of the Tariff Act of 1930, the ITC investigates complaints by domestic industries that goods imported into the United States violate U.S. intellectual property rights or through other methods of unfair competition. Thus, ITC investigations enable intellectual property owners that operate in domestic industries to enforce U.S. patent rights against infringing imports.

The ITC experienced a significant increase in patent enforcement actions after the Supreme Court's ruling in *eBay, Inc. v. MercExchange, L.L.C.*, 547 U.S. 388 (2006), owing to the greater availability of injunctive-type relief and rapid adjudication relative to district court proceedings. The ITC is not bound by *eBay*, which made injunctive relief less available in district court actions. See *Spansion, Inc. v. Int'l Trade Comm'n*, 629 F.3d 1331, 1359 (Fed. Cir. 2010) (holding the ITC "is not required to apply the traditional four-factor test for injunctive relief"). Where an ITC proceeding finds patent infringement, the ITC generally issues exclusion orders barring importation of the infringing articles into the United States. With regard to adjudication speed, the Trade Act directs the ITC to resolve cases "at the earliest practicable time," which generally translates into an eighteen-month process after commencement of the investigation. See Uruguay Round Amendments Act of 1994, Pub. L. 103-465, § 321, 103d Cong., 2d Sess., 108 Stat. 4809 (1994); Trade Act of 1974, Pub. L. No. 93-618, § 341, 88 Stat. 1978, 2053 (1975) (amending § 337(b) of the Tariff Act of 1930).

Patent holders often seek relief from the ITC and U.S. district courts simultaneously. This raises several case-management issues for district courts. We focus here on the granting of stays pending resolution of the ITC action and the effect of the ITC action on the district court's resolution of patent issues.

2.2.6.2.1 Stays Relating to Parallel ITC Proceedings

Under 28 U.S.C. § 1659(a), parties to a civil action that are also respondents in a parallel proceeding before the ITC can move for a stay of the district court proceedings as a matter of right:

(a) Stay. — In a civil action involving parties that are also parties to a proceeding before the United States International Trade Commission under section 337 of the Tariff Act of 1930, at the request of a party to the civil action that is also a respondent in the proceeding before the Commission, the district court shall stay, until the determination of the Commission becomes final, proceedings in the civil action with respect to any claim that involves the same issues involved in the proceeding before the Commission, but only if such request is made within — (1) 30 days after the party is named as a respondent in the proceeding before the Commission, or (2) 30 days after the district court action is filed, whichever is later.

Id.; see *In re Princo Corp.*, 478 F.3d 1345, 1355 (Fed. Cir. 2007).

As noted in the statute, the stay remains in effect until the determination of the ITC becomes final. After the dissolution of the stay, § 1659(b) allows the parties to use the ITC investigation record in the district court proceeding.

(b) Use of Commission Record. — Notwithstanding section 337(n)(1) of the Tariff Act of 1930, after dissolution of a stay under subsection (a), the record of the proceeding before the United States International Trade Commission shall be transmitted to the district court and shall be admissible in the civil action, subject to such protective order as the district court determines necessary, to the extent permitted under the Federal Rules of Evidence and the Federal Rules of Civil Procedure.

Id.

Although the stay provided for in § 1659(a) is mandatory, it only applies to “any claim that involves the same issues involved in the proceeding before the Commission.” Usually this is interpreted as applying only to the patents that the ITC and judicial proceedings have in common. In cases involving additional patents not at issue in an ITC proceeding, courts are often asked to stay the entire proceeding. In deciding whether to grant such a stay, the district court will typically balance several factors. For example, in *FormFactor, Inc. v. Micronics Japan Co., Ltd.*, the district court granted a motion to stay pursuant to § 1659(a) only after considering “(1) possible damage which may result from the granting of a stay; (2) the hardship or inequity which a party may suffer in being required to go forward; and (3) the orderly course of justice measured in terms of the simplifying or complicating of issues, proof, and questions of law which could be expected to result from a stay.” 2008 U.S. Dist. LEXIS 13114, 2008 WL 361128 (N.D. Cal. 2008). Only two of the four patents under consideration in the district court were at issue in the ITC proceeding. Nonetheless, the court ruled that the two remaining patents shared subject matter and common inventors with the patents at issue in the ITC proceeding, and therefore a stay of the action was warranted to avoid duplicative efforts in discovery. Similarly, the court in *ILJIN U.S.A. v. NTN Corp.* found that numerous factors weighed in favor of granting a stay, including the following:

- (1) the ITC claim was filed before the district court complaint;
- (2) the proceedings were more advanced in the ITC case than in the district court;
- (3) there had not been substantial discovery in the case;
- (4) indisputably, it would conserve judicial resources to allow the ITC investigation to at least narrow the issues before the district court case proceeded, with the added benefit of potentially avoiding conflicting decisions;
- (5) the ITC is more experienced in deciding patent disputes than the district court; and
- (6) the complainant did not present any persuasive reason why a stay should not issue.

2006 U.S. Dist. LEXIS 15389, 2006 WL 568351 (E.D. Mich. 2006).

A district court must also decide whether to stay its proceedings as to all of the claims at issue, even if only a portion of those claims are involved in a § 337 investigation. For example, in *Micron Technology, Inc. v. Mosel Vitelic Corp.*, the defendants moved to stay the district court proceedings for all the claims that were not at issue before the ITC. 1999 U.S. Dist. LEXIS 4792, 1999 WL 458168 (D. Idaho 1999). The defendants argued that because of the substantial overlap of legal and factual issues, a stay of all the claims, including those not at issue before the ITC, “would enhance judicial economy” as well as “provide the Court with the benefit of the find-

ings, conclusions and views of the ITC.” *Id.* at *4. Moreover, the defendants insisted that while they would be prejudiced by litigating in multiple forums, the plaintiff would not be prejudiced by a stay because it will obtain a timely resolution of the claims before the ITC. *Id.* Yet in denying the motion, the court concluded that the defendants failed to establish that a stay of the instant proceedings was “necessary to prevent undue hardship or injustice.” *Id.* at *5. The court further noted that a party moving for a stay “must make out a clear case of hardship or inequity in being required to go forward, if there is even a fair possibility that the stay for which he prays will work damage to someone else.” *Id.* at *4 (quoting *Landis v. N. Am. Co.*, 299 U.S. 248, 255 (1936)). In sum, the *Micron* court denied the motion to stay and ordered discovery with respect to the claims not before the ITC. *Id.* at *5.

In contrast, the court in *Alloc, Inc. v. Unilin Decor, N.V.* took the alternative approach and entered a stay for all the claims. 2003 U.S. Dist. LEXIS 11917, 2003 WL 21640372 (D. Del. 2003). The court noted that “even though the ’579 patent does not contain precisely the same claims of the other patents that are under review or reexamination, there is a sufficient correlation among all of the patents for the court to conclude that a stay is appropriate.” In this case, although the ’579 patent was not part of the ITC proceeding, it claimed priority to and shared a specification with an earlier ’621 patent that was part of the ITC proceeding. *Id.* at *1. In issuing the stay, the court noted that it “would benefit from a narrowing of the numerous complex issues relating to the claims.” *Id.* at *2. Moreover, the court noted that discovery had not yet begun, nor had a trial date been set. *Id.* at *3. Indeed, neither party had incurred substantial, litigation-related expenses. *Id.*

Thus despite the statutory mandate of 28 U.S.C. § 1659(a), a respondent may still be required to make out a clear case of hardship or inequity before a stay will be entered. Where the patent before the district court is related to a patent before the ITC, however, a court might enter a stay to narrow complex issues and avoid duplicative discovery.

2.2.6.2.2 Effect of ITC Rulings on District Court Proceedings

The general intellectual property jurisdiction statute, 28 U.S.C. § 1338 grants federal courts original and exclusive jurisdiction of civil actions “arising under any Act of Congress relating to patents.” As a result, ITC patent determinations—such as claim construction, validity, infringement, and defenses—do not have preclusive effect in subsequent district court litigation. See *Tex. Instruments, Inc. v. Cypress Semiconductor Corp.*, 90 F.3d 1558, 1568–69 (Fed. Cir. 1996); *but cf. Balt. Luggage Co. v. Samsonite Corp.*, 977 F.2d 571 (4th Cir. 1992) (affording preclusive effect to affirmative defenses raised during ITC investigation because the party raising the defense had a full and fair opportunity to litigate the defense before the ITC); *Union Mfg. Co. v. Han Baek Trading Co.*, 763 F.2d 42 (2d Cir. 1985) (holding that ITC trademark determinations have res judicata effect on subsequent federal court proceedings). Nonetheless, district courts can and do consider ITC rulings in assessing cases. See, e.g., *Glasstech Inc. v. AB Kyro O.Y.*, 635 F. Supp. 465, 468 (N.D. Ohio 1986); *Mentor Graphics Corp. v. Quickturn Design Sys.*, 999 F. Supp. 1388, 1393 (D. Or. 1997).

2.2.6.3 Parallel District Court Proceedings

It is not uncommon for patent holders to pursue infringement actions involving the same patent in different jurisdictions at the same time as a result of jurisdiction and venue considerations. Furthermore, co-pending litigations relating to the same patent can occur when companies under threat of patent enforcement pursue declaratory judgment of invalidity, noninfringement, or unenforceability in a jurisdiction other than where a patent holder is seeking to enforce the patent against other entities. The AIA will likely increase the likelihood of such proceedings by limiting joinder of unrelated defendants in patent cases. *See* § 2.2.2.1.1.

The co-pendency of litigation involving the same patent can result in duplicative expenditure of judicial resources and impose unnecessary burdens on parties. Litigants have several tools for addressing these concerns: (1) transfer of venue, addressed in § 2.3.3.1; (2) coordination of litigation across districts through provisions governing multidistrict litigation, addressed in § 2.3.4; and/or (3) requests to stay one or more proceedings pending resolution of common issues, particularly patent validity. The standards for stays parallel those for transfer of venue. Although the specific standards differ slightly among circuits, courts typically consider the following factors in evaluating a motion to stay: (1) whether a stay would cause undue prejudice to the nonmoving party; (2) whether a stay will simplify the issues for trial; and (3) whether discovery is complete and a trial date is set.

The public policy favoring expeditious resolution of disputes is of particular weight when dealing with wasting assets such as patents. *See Katz v. Lear Siegler, Inc.*, 909 F.2d 1459, 1464 (Fed. Cir. 1990). Nonetheless, when two actions involving nearly identical parties and closely related patent infringement questions are filed in separate districts, the general rule is that the case first filed takes priority. The subsequently filed suit should be dismissed, transferred, or stayed. *See Kerotest Mfg. Co. v. C-O-Two Fire Equip. Co.*, 342 U.S. 180 (1952); *Genentech, Inc. v. Eli Lilly & Co.*, 998 F.2d 931 (Fed. Cir. 1993); *see generally* 14D Charles Alan Wright & Arthur R. Miller, Federal Practice and Procedure § 3823 (3d ed. 1998). The first-to-file presumption applies to declaratory judgments as well. *See Wilton v. Seven Falls Co.*, 515 U.S. 277, 289 (1995) (“As a general rule, a first-filed declaratory judgment suit will be entitled to precedence over a later-filed patent infringement action.”); *Sanofi-Aventis Deutschland GmbH v. Novo Nordisk, Inc.*, 614 F. Supp. 2d 772, 774 (E.D. Tex. 2009); *but cf. Uniroyal Engineered Prods., LLC v. Omnova Sols. Inc.*, 2009 U.S. Dist. LEXIS 22518, 2009 WL 736700, *1 (W.D. Wis. 2009) (“In general, when a declaratory judgment action and a patent infringement action are filed within days of each other, it is more appropriate to consider the convenience factors of 28 U.S.C. § 1404(a) rather than applying the rigid rule that the first-filed action trumps the later-filed action.”).

The first-to-file rule “is a doctrine of federal comity, intended to avoid conflicting decisions and promote judicial efficiency, that generally favors pursuing only the first-filed action when multiple lawsuits involving the same claims are filed in different jurisdictions.” *Merial Ltd. v. Cipla Ltd.*, 681 F.3d 1283, 1299 (Fed. Cir. 2012). “When two actions that sufficiently overlap are filed in different federal district courts, one for infringement and the other for declaratory relief, the declaratory

judgment action, if filed later, generally is to be stayed, dismissed, or transferred to the forum of the infringement action.” *Futurewei Techs., Inc. v. Acacia Research Corp.*, 737 F.3d 704, 708 (Fed. Cir. 2013). The first-to-file rule, however, “is not rigidly or mechanically applied—an ample degree of discretion, appropriate for disciplined and experienced judges, must be left to the lower courts.” *Merial*, 681 F.3d at 1299. Exceptions may be made if justified by “considerations of judicial and litigant economy, and the just and effective disposition of disputes.” *Futurewei*, 737 F.3d at 708. Resolution of whether the second-filed action should proceed presents a question sufficiently tied to patent law that the question is governed by the law of the Federal Circuit. *Id.* Although the forum of the first-filed action is favored, exceptions “are not rare, and are made when justice or expediency requires[.]” *Genentech, Inc.*, 998 F.2d at 937 (citing *Kahn v. Gen. Motors Corp.*, 889 F.2d 1078, 1081–83 (Fed. Cir. 1989)) (discussing the general rule, the “customer suit” exception, and other factors that overcome “the presumptive right of the first litigant to choose the forum). In weighing venue transfer or stay motions, courts have looked to:

- the status of the co-pending case, *Elite Licensing, Inc. v. Thomas Plastics, Inc.*, 2003 U.S. Dist. LEXIS 2439, 2003 WL 473669 (S.D.N.Y. 2003) (where the first-filed case was dismissed for improper venue); *Schnadig Corp. v. Collezione Europa U.S.A.*, 2001 U.S. Dist. LEXIS 9208, 2001 WL 766898 (N.D. Ill. July 3, 2001) (where the co-pending case is likely to be dismissed);
- harm caused by delaying the stayed issues, *see Kahn v. Gen. Motors Corp.*, 889 F.2d 1078, 1082–83 (Fed. Cir. 1989);
- whether the other forum lacks jurisdiction over all necessary or desirable parties;
- the possibility of consolidation, *see SAES Getters S.p.A. v. Aeronex, Inc.*, 219 F. Supp. 2d 1081, 1092 (S.D. Cal. 2002) (emphasizing the importance that related patents are construed consistently);
- convenience of the parties; and
- judicial economy, *see Serco Servs. Co., L.P. v. Kelley Co., Inc.*, 51 F.3d 1037, 1040 (Fed. Cir. 1995).

Nonetheless, that the first-filed claim anticipated the later-filed claim is not, without more, a sufficient ground to rebut the first-to-file presumption, *see Elecs. for Imaging, Inc. v. Coyle*, 394 F.3d 1341, 1347–48 (Fed. Cir. 2005), but it can be a factor in the broader balance governing whether to apply the first-to-file rule. *Serco Servs.*, 51 F.3d at 1040.

Stays of co-pending patent litigation involving different parties have been most commonly granted in “customer suit” situations. As the name implies, such litigation arises when the patent holder is engaged in one litigation against a provider of the accused technology and separate litigation against the purchaser of the accused technology. Based on language in *Katz v. Lear Siegler, Inc.*, 909 F.2d 1459, 1464 (Fed. Cir. 1990); *see also Codex Corp. v. Milgo Elec. Corp.*, 553 F.2d 735, 737–38 (1st Cir. 1977) (preference for a manufacturer’s declaratory judgment action because the manufacturer is the true defendant), courts in some circumstances have stayed patent litigation against such customers pending the outcome of the supplier suit, prin-

cially, as in *Katz*, where resolution of liability with respect to the supplier will resolve liability with respect to the customer. Cases involving the same patent and same parties (e.g., a declaratory judgment action brought by the accused infringer and a patent infringement action brought by the patent holder) are typically resolved by the first-to-file rule: the earlier-filed case takes precedence, and the later-filed case is transferred, stayed, or dismissed.

Given the above-referenced proliferation of co-pending litigations involving the same patent, it seems likely that courts will increasingly be asked to decide whether some of those suits should be stayed. At least some such motions will be filed at the outset of the case, before any discovery occurs. Because the stay factors balance the specific benefits to be gained from the stay with the specific prejudice that is likely to be suffered by the nonmovant, as well as the stage of the litigation, the merits of such motions are fact-intensive and can vary substantially from case to case. That said, such motions raise several issues for courts to consider. First, because the plaintiff often files all, or many, of the co-pending litigations on the same day, it may be difficult or impossible for a court to identify a case or cases that naturally take precedence over others. Indeed, even if the various defendants agree that some cases should be stayed pending resolution of others, it is very likely that the defendants will disagree about whose case should proceed first. Thus, a California court may be asked to stay a case pending resolution of a Delaware case, while the Delaware court is asked to stay that same Delaware case pending resolution of the same California case. As a practical matter, many courts are likely to avoid wading into those murky waters.

Moreover, even where one case or a group of cases clearly takes precedence (e.g., first-filed), if the subsequent cases were filed soon after the case deemed to have precedence, the patent holder will likely argue that the stay will be prejudicial and that the possibility of case-narrowing is illusory—indeed, it may require the patent holder’s claims against some defendants to sit for years while other litigation is resolved. In addition, the possibility that the case(s) deemed to have precedence will not actually resolve issues that narrow the case sought to be stayed (because of settlement, because the patent holder prevails, or otherwise) and that, even when the same patent claims are asserted, the claim-construction and invalidity issues may differ substantially (e.g., because the patent holder’s infringement allegations against the various defendants differ) are also likely to be considered. For these reasons, where the request to stay is filed at the outset of the case, most courts will consider other options, such as MDL, to achieve efficiency, or elect to proceed with the case normally. Of course, the stage of the case deemed to have precedence can alter this analysis substantially—if, for example, a request seeks to stay a case in its infancy to await resolution of a case that is on the eve of a trial at which invalidity is at issue, the factors may weigh strongly toward stay; likewise, if the case deemed to have precedence is pending in a venue with a short time-to-trial, that may also weigh strongly in favor of a stay. Because of the nature of the stay factors, relevant considerations can vary widely. Courts should evaluate such motions carefully on a case-by-case basis.

2.2.6.4 PTO Review Proceedings—Reexamination, Reissue, and AIA Review

The Patent Office has long provided various forms of administrative review of patent validity and scope. Minor mistakes in a patent, such as typographical errors and misnamed or omitted inventors, can be corrected through a certificate of correction. *See* §§ 254–256. Since 1836, the Patent Act has provided for reissuance of defective patents. Under the 1952 Act, patentees can seek broadening reissues within a two-year window following issuance and can narrow patent claims at any time during the patent’s duration. *See* §§ 251–252. Since 1981, the Patent Office has authorized any person—whether the patent owner, an accused infringer, or a third party—to seek *ex parte* reexamination of patents. *See* §§ 301–307. In 1999, Congress sought to bolster reexamination by establishing an *inter partes* option that allowed third-party requesters to participate in the reexamination process.

These procedures, however, had little effect on the vast majority of patent cases until recently. Correction and reissue processes typically took place before or outside of patent litigation. Because requesters are not permitted to participate in *ex parte* reexamination once granted, relatively few parties considered it worth pursuing unless they had an ironclad invalidity case. Their concern was that, if the attempt failed, the reexamination certificate would reinforce or “gold-plate” the patent’s validity to a jury. Even with the establishment of *inter partes* reexamination, potential challengers worried about long delays, a perceived pro-patentee tilt, and severe estoppel effects on district court challenges.

The AIA’s institution of three new review processes—*inter partes* review (IPR), covered business method review (CBMR), and postgrant review (PGR)—in 2011 has invigorated patent validity proceedings at the Patent Trial and Appeal Board (PTAB). The AIA mandates that these reviews proceed expeditiously in a streamlined process. As a result, a significantly higher percentage of defendants seek administrative review of patents asserted against them. The USPTO has hired more than 200 administrative patent judges (APJs) to review petitions. They sit in three-APJ panels to resolve validity challenges.

Recent Federal Circuit decisions regarding the effect of USPTO procedures on litigation are expected to increase their attractiveness to alleged infringers. In *Fresenius USA, Inc. v. Baxter Int’l, Inc.*, the court held that the cancellation of the asserted patent claims in a reexamination vitiated a judgment of infringement that had been stayed pending appeal. 721 F.3d 1330, 1332 (Fed. Cir. 2013). The decision rested on a holding that the judgment was not actually final, despite having been labeled as such. *Id.* at 1341–42, 1344. In *ePlus v. Lawson Software*, the Federal Circuit dissolved an injunction and contempt order that had been entered against an adjudged infringer because reexamination had canceled the patent claim on which they were based. 760 F.3d 1350, 1352 (Fed. Cir. 2014). It bears noting that in both *Fresenius* and *ePlus*, the Federal Circuit had earlier affirmed the USPTO’s decision to cancel the claim in a separate appellate proceeding. Because defendants believe these cases give them “two bites at the apple” to show invalidity, district courts can expect parallel postgrant reviews and *inter partes* reviews to become common.

2.2.6.4.1 Stays Pending Review or Reexamination

Patent Office processes principally affect patent case management through stays pending Patent Office review. Stay requests were less common, and even less often granted, in the pre-AIA era. District courts were reluctant to trust the Patent Office to expeditiously reexamine patents. The situation could not be more different today. A high and growing percentage of patents in litigation are pursued in parallel at the PTAB and courts are far more inclined to stay litigation pending PTAB review.

District courts have wide discretion to stay litigation pending reexamination or reissue. See *Viskase Corp. v. Am. Nat'l Can Co.*, 261 F.3d 1316, 1328 (Fed. Cir. 2001) (citing *Patlex Corp. v. Mossinghoff*, 758 F.2d 594 (Fed. Cir. 1985)).⁹ “In determining whether to grant a stay, courts routinely considered three factors: (1) whether a stay would unduly prejudice or present a clear tactical disadvantage to the nonmoving party; (2) whether a stay will simplify the issues in question and trial of the case; and (3) whether discovery is complete and whether a trial date has been set.” *Magna Donnelly Corp. v. Pilkington N. Am., Inc.*, 2007 U.S. Dist. LEXIS 17536, at *6, 2007 WL 772891 (W.D. Mich. Mar. 12, 2007); *Fresenius Med. Care Holdings, Inc. v. Baxter Int'l, Inc.*, No. C 03-1431 SBA, 2007 U.S. Dist. LEXIS 44107, 2007 WL 1655625 (N.D. Cal. June 6, 2007); see also *MercExchange, L.L.C. v. eBay, Inc.*, 500 F. Supp. 2d 556, 563 (E.D. Va. 2007) (courts consider the stage of discovery, whether a trial date has been set, and whether a stay will unduly prejudice the nonmoving party). Stays are less appropriate when the USPTO proceedings are initiated late in the litigation. See, e.g., *IMAX Corp. v. In-Three, Inc.*, 385 F. Supp. 2d 1030, 1033–34 (C.D. Cal. 2005); *Gladish v. Tyco Toys*, No. S-92-1666 WBS, 1993 U.S. Dist. LEXIS 20211, at *6–8, 1993 WL 625509 (E.D. Cal. 1993).

Notwithstanding the potential benefits of staying litigation to receive the Patent Office's expertise in examining validity in reexamination, district courts were often skeptical that reexamination proceedings would conclude in a timely and effective manner. Patent Office statistics confirmed this perception. Concerns with both the slow processing of reexamination proceedings as well as the high costs of district court litigation led Congress to expand and expedite Patent Office review proceedings in the AIA. Beginning September 15, 2012, the AIA replaced inter partes reexamination with inter partes review (IPR), with a mandate that the Patent Office decide whether to institute an IPR petition within six months of the filing of a petition and render a decision within one year of institution. See generally § 14.2.5.6. The AIA also added a broader review for covered business methods (CBMR) and instituted a postgrant review (PGR) process to be undertaken during the first nine months after a patent issues. It also consolidated and expanded administrative resources within the Patent Trial and Appeal Board (PTAB).

9. A district court's discretion to stay proceedings does not, however, empower the court to direct that a party file a reexamination or reissue in the PTO, nor does it empower the court to place conditions on the stay that exceed its inherent power to manage its docket. *Emerson Elec. Co. v. Davoil, Inc.*, 88 F.3d 1051, 1053–54 (Fed. Cir. 1996) (reversing stay conditioned on party's agreement to submit to the PTO documents prepared by the patent litigation defendant).

The newly implemented PTAB review processes have effected a sea change in patent enforcement, review, and case management. The relatively low cost and swift processing of IPRs and CBMs in conjunction with both high review institution and invalidation rates have caused a veritable stampede by alleged infringers, potential defendants, and some nongovernmental organizations to the PTAB. From September 15, 2012, the effective date for IPR and CBMR proceedings, through March 15, 2015, parties have filed over 3,000 petitions—more than 2,700 IPRs and 300 CBMRs. See USPTO, AIA Progress (Apr. 9, 2015), http://www.uspto.gov/sites/default/files/documents/040915_aia_stat_graph.pdf. The PTAB has instituted review in approximately 80% of the petitions. As of April 2015, approximately one-third of the petitions have been terminated by settlement or decision. As of January 15, 2015, approximately 36% of claims for which IPR was instituted were found unpatentable. See USPTO, *Inter Partes* Review Petitions Terminated to Date (Jan. 15, 2015) http://www.uspto.gov/sites/default/files/documents/inter_partes_review_petitions_terminated_to_date%2001%2015%202015.pdf.

As a result, motions to stay litigation pending resolution of the IPR proceedings as well as grant rates for litigation stays have risen sharply. District courts stayed litigation pending IPR in approximately 75% of cases through December 9, 2014. See Scott A. McKeown, *District Courts Increasingly Await PTAB Decision*, Patents Post-Grant Blog (Dec. 23, 2014) <http://www.patentspostgrant.com/district-courts-increasingly-await-ptab-outcome>; see also *Capriola Corp. v. La Rose Indus., LLC*, 2013 U.S. Dist. LEXIS 65754, 2013 WL 1868344 (M.D. Fla. Mar. 11, 2013) (“if the PTO declines *inter partes* review, little time is lost, but if PTO grants *inter partes* review, the promise is greater for an important contribution by the PTO to resolution of the governing issues in the litigation.”). The rate of stay grants varies across districts and judges. The Northern District of California granted 85% of IPR stay motions through September 2014, while the Eastern District of Texas had granted 13% of stay petitions. See Goodwin Procter, *The PTAB Second Anniversary: Reflections and Strategies for the Years Ahead*, IP Advisor (Sept. 2014) <http://www.goodwinprocter.com/~media/Files/Publications/Newsletters/IP%20Advisor/2014/Goodwin%20Procter%20IP%20Advisor%20PTAB%202nd%20Anniversary%20Edition.PDF>.

2.2.6.4.2 Evaluating Stay Requests with Pending AIA Review

Most courts continue to evaluate stay motions according to the same three-factor test articulated prior to the passage of the AIA. See *Semiconductor Energy Lab. Co. v. Chimei Innolux Corp.*, 2012 U.S. Dist. LEXIS 186322, 2012 WL 7170593, at *1, n.1 (C.D. Cal. Dec. 19, 2012) (“The Court sees no reason why the three factor assessment would not still be relevant [to the new *inter partes* review proceeding].”). The decision remains based on the “totality of the circumstances” and the inquiry is not limited to the three factors commonly cited. See *Universal Elecs., Inc. v. Universal Remote Control, Inc.*, 943 F. Supp. 2d 1028, 1030–31 (C.D. Cal. 2013). Because the PTAB has six months to decide whether to institute an IPR proceeding after a petition is filed, § 314(b), and the scope of the proceeding will not be known until it is instituted, many courts have expressed reluctance to stay a case merely on the filing

of a petition. See, e.g., *Dane Techs., Inc. v. Gatekeeper Sys., Inc.*, 2013 U.S. Dist. LEXIS 117718, 2013 WL 4483355, at *4 (D. Minn. Aug. 20, 2013) (“Before the PTO makes this decision the Court can only speculate as to whether the PTO will review a patent and to what extent.”); *Ultratec, Inc. v. Captel, Inc.*, 2014 U.S. Dist. LEXIS 120062 at *6–7 (W.D. Wis. Nov. 14, 2013) (stay pending the PTAB’s decision on the petition “adds an additional layer of doubt whether the inter partes review will even occur, let alone whether it will simplify the issues or reduce the burden of litigation for the parties or the court”); *One StockDuq Holdings, LLC v. Becton, Dickinson & Co.*, 2013 U.S. Dist. LEXIS 36621, 2013 WL 1136726, at *3 (W.D. Tenn. May 6, 2013) (denying stay because “the PTO has not yet granted Defendant’s Petition for reexamination and it is possible that the PTO will never grant Defendant’s Petition” and “staying the case at this juncture could result in an unnecessary delay of six months”).

One important issue in assessing a stay motion is whether the PTAB review would potentially resolve the full range of claims before the court. The stay motion presents the court with the opportunity to clarify the potential ramifications of the PTAB review. If a successful challenge would not resolve the outstanding questions, the court can explore the possibility of stipulations to streamline the district court litigation.

2.2.6.4.3 Special Case: Stay Request with Pending CBMR

Courts have shown greater willingness to stay litigation pending covered business method review (CBMR). The CBMR process was conceived as a transitional program for patents that claim “method or corresponding apparatus for performing data processing or other operations used in the practice, administration, or management of a financial product or service, [excluding patents for technological inventions].” AIA § 18(d)(1). The patentability of business methods has been especially controversial, with the Supreme Court substantially limiting eligibility for these claims. See §§ 14.3.1.2.4, 14.3.1.2.5, 14.3.1.3. Since the creation of CBMR, the PTO has interpreted the scope of the CBM procedure broadly. For instance, in *Salesforce v. VirtualAgility*, CBM 2013-00024, Paper No. 16 (P.T.A.B. Nov. 19, 2013), the PTAB instituted a CBMR for a patent even though the patent claim did not expressly refer to financial activity.

District courts have been lenient in granting stays pending CBMR, recognizing that the statutory language in the AIA regarding CBMRs was intended to encourage a higher rate of stays. *Market-Alerts Pty. Ltd. v. Bloomberg Fin. L.P.*, 922 F. Supp. 2d 486, 489, 496 (D. Del. 2013) (recognizing a fourth factor when considering a motion to stay pending CMBR—“whether a stay, or the denial thereof, will reduce the burden of litigation on the parties and on the court”—and acknowledging the addition of this factor was intended to encourage a higher rate of stays pending CBMR); *Ver-sata Software, Inc. v. Volusion, Inc.*, 2013 U.S. Dist. LEXIS 182842, 2013 WL 6912688, at *2 (W.D. Tex. June 20, 2013) (instituting a stay pending CBMR based on the four-factor test and “Congress’s clear preference in favor of stays”); *Progressive Cas. Ins. Co. v. Safeco Ins. Co.*, 2013 U.S. Dist. LEXIS 54899, 2013 WL 1662952 (N.D. Ohio Apr. 17, 2013) (reviewing the legislative history, which indicates the new CMBR is “designed to provide a cheaper, faster alternative to district court litigation

over the validity of business-method patents”); *Zillow v. Trulia*, 2013 U.S. Dist. LEXIS 144919, 2013 WL 5530573, at *3 (W.D. Wash. Oct. 7, 2013) (“the fourth factor was added in order to ease the movant’s task in demonstrating the need for a stay”). Section 18(b)(2) also provides that a party may make an interlocutory appeal from a district court’s grant or denial of stay pending CBMR. See *VirtualAgility, Inc. v. Salesforce.com, Inc.*, 759 F.3d 1307 (Fed. Cir. 2014) (reversing district court decision to deny a stay even under an abuse-of-discretion standard). However, the Federal Circuit does “not have jurisdiction under § 18(b)(2) . . . to consider an interlocutory appeal from a decision on a motion to stay until the PTAB institutes a CBMR proceeding.” *Intellectual Ventures II LLC v. JPMorgan Chase & Co.*, 781 F.3d 1372 (Fed. Cir. 2015).

2.2.6.5 Preemption of State-Law Unfair Competition Claims

Federal patent law preempts state tort law (e.g., for unfair competition) where the patentee has acted in good faith in its communications to others regarding alleged infringement. See, e.g., *Viskase Cos. v. World Pac. Int’l AG*, 710 F. Supp. 2d 754, 756 (N.D. Ill. 2010) (citing *Globetrotter Software, Inc. v. Elan Computer Grp., Inc.*, 362 F.3d 1367, 1374 (Fed. Cir. 2004)). “[T]o avoid preemption, bad faith must be alleged and ultimately proven, even if bad faith is not otherwise an element of the tort claim.” *Globetrotter*, 362 F.3d at 1374 (internal quotation marks omitted).

2.2.7 Rule 11: Presuit Investigations—Objective Good-Faith Basis for Filing Pleading

Rule 11 requires that a party filing a complaint has sufficiently investigated to form a good-faith basis for its claims. Thus, a patentee must exercise reasonable diligence to ascertain infringement before filing suit. This process must include a reasonable investigation into the interpretation of the claims. *Judin v. United States*, 110 F.3d 780, 784 (Fed. Cir. 1997). Because patents are presumed valid under § 282, a patent holder has no obligation to assess validity prior to filing infringement claims. See *Q-Pharma, Inc. v. Andrew Jergens Co.*, 360 F.3d 1295, 1303 (Fed. Cir. 2004); *Vigil v. Walt Disney Co.*, 2000 U.S. App. LEXIS 6231, at *1–2, 2000 WL 353148 (Fed. Cir. 2000).

The level of inquiry may vary according to the nature of the allegedly infringing product or process since some infringement (for example, of software patents) is difficult to ascertain from publicly available information. See *Woods v. DeAngelo Marine Exhaust, Inc.*, 692 F.3d 1272, 1288–89 (Fed. Cir. 2012); *Judin*, 110 F.3d at 784. If an accused product is readily obtainable and easily examined, courts tend to hold that it is reasonable to expect the patent owner to examine it, or have a reasonable explanation for not doing so. *Judin*, 110 F.3d at 784 (holding that patent owner and attorney had acted unreasonably when they had not “attempted to obtain a device from the [defendant] or the manufacturer so that they could more closely observe the device, nor was any attempt made to dissect or ‘reverse-engineer’ a sample device”); *Refac Int’l Ltd. v. Hitachi Ltd.*, 141 F.R.D. 281, 286 (C.D. Cal. 1991); *c.f. Vista Mfg. Inc. v. Trac-4 Inc.*, 131 F.R.D. 134, 138 (N.D. Ind. 1990) (declining to

“recognize a general rule that Rule 11 requires an infringement plaintiff to examine the defendant’s product in all instances”). If it is not possible for a patent owner to fully investigate infringement (e.g., the invention is a patented method that the potential defendant practices in secret), Rule 11 permits a party to proceed by specifically identifying in its pleadings those factual contentions that will “likely have evidentiary support after a reasonable opportunity for further investigation or discovery,” distinguishing them from those factual contentions that “have evidentiary support” Fed. R. Civ. P. 11(b)(3).

2.3 Jurisdiction and Venue

2.3.1 Personal Jurisdiction

Personal jurisdiction is analyzed under the familiar two-part test: whether the applicable state long-arm statute is satisfied and whether the exercise of personal jurisdiction is consistent with the Due Process Clause of the Constitution. *Silent Drive, Inc. v. Strong Indus., Inc.*, 326 F.3d 1194, 1200, 1201 (Fed. Cir. 2003); *Inamed Corp. v. Kuzmak*, 249 F.3d 1356, 1359–60 (Fed. Cir. 2001). Patent cases typically do not raise substantial issues of personal jurisdiction since the defendant is alleged to have sold or offered for sale infringing products within the district, which usually provides specific personal jurisdiction over the infringement dispute. Personal jurisdiction issues can arise, however, in ANDA cases (discussed in Chapter 10) or where non-U.S.-based parties are alleged to have infringed.

In *Daimler AG v. Bauman*, the Supreme Court held that a court’s exercise of general jurisdiction is appropriate only when a defendant’s affiliations with the forum state are so continuous and systematic as to render it “essentially at home” in that state. 134 S. Ct. 746, 755 (2014) (quoting *Goodyear Dunlop Tires Operations, S.A. v. Brown*, 131 S. Ct. 2846, 2851 (2011)). This ruling has particular implications for Hatch-Waxman Act-based ANDA cases, as more generic company defendants may elect to challenge personal jurisdictions in districts that are neither the generic company’s principal place of business nor their place of incorporation. Chapter 10.2.1 discusses this case’s impact on ANDA litigation in further detail.

Plaintiffs typically rely on the “stream of commerce” theory of personal jurisdiction advanced in *Asahi Metal Industry Co. v. Superior Court of California, Solano County*, 480 U.S. 102 (1987). See, e.g., *Freescale Semiconductor, Inc. v. Amtran Tech. Co.*, 2014 U.S. Dist. LEXIS 58044, 2014 WL 1603665 (W.D. Tex. Mar. 19, 2014) (granting renewed motion to dismiss for lack of personal jurisdiction under the “stream of commerce” theory). *Asahi* includes two plurality opinions embodying two different tests for stream of commerce, the *O’Connor* test (defendant must perform some act with respect to its products purposefully directed towards the forum) and the *Brennan* test (sufficient if reasonably foreseeable products would enter the forum). The Supreme Court’s later decision in *J. McIntyre Machinery Ltd. v. Nicastro*, 131 S. Ct. 2780 (2011), has not resolved the different tests, and the Federal Circuit has so far declined to take a position on either of the two tests. See *AFTG-TG, LLC v. Nuvoton Tech. Corp.*, 689 F.3d 1358, 1363 (Fed. Cir. 2012) (“the law [on

stream of commerce] remains the same after *McIntyre*); *Beverly Hills Fan Co. v. Royal Sovereign Corp.*, 21 F.3d 1558, 1566 (Fed. Cir. 1994). Given the uncertainty surrounding the “stream of commerce” test, the Federal Circuit has emphasized the importance of jurisdictional discovery. See *Trintec Indus., Inc. v. Pedre Promotional Prods., Inc.*, 395 F.3d 1275, 1283 (Fed. Cir. 2005) (vacating trial court’s dismissal for lack of personal jurisdiction and remanding for jurisdictional discovery, upon finding existing record was inadequate and jurisdictional allegations could be supplemented through discovery); *Commissariat a l’Energie Atomique v. Chi Mei Optoelectronics Corp.*, 395 F.3d 1315, 1319 (Fed. Cir. 2005) (vacating trial court’s dismissal for lack of personal jurisdiction and remanding for jurisdictional discovery, upon a finding that the record sufficiently supported jurisdiction under the *Brennan* test, but was inadequate for a determination under the *O’Connor* test); see also *GrafTech Int’l Holdings Inc. v. G&CS Co.*, No. 2:12-cv-720, ECF No. 39 (E.D. Tex. Apr. 8, 2014) (denying without prejudice foreign defendant’s motion to dismiss for lack of personal jurisdiction and ordering the parties to pursue jurisdictional discovery).

2.3.2 Subject-Matter Jurisdiction

2.3.2.1 Original Jurisdiction

Under 28 U.S.C. § 1338(a), federal district courts have exclusive original jurisdiction of “any civil action arising under any Act of Congress relating to patents.” In *Christianson v. Colt Industries Operating Corp.*, the Supreme Court held that “cases fall within the Federal Circuit’s patent jurisdiction in the same sense that cases are said to ‘arise under’ federal law for purposes of federal question jurisdiction.” 486 U.S. 800, 814 (1988) (quotation omitted). See also *Warrior Sports, Inc. v. Dickinson Wright, P.L.L.C.*, 631 F.3d 1367 (Fed. Cir. 2011) (holding that a malpractice claim brought under Michigan law arose under federal law because it required the district court to resolve a substantive issue of patent law). The familiar “well-pleaded complaint” rule determines whether a case “arises under” federal law. Most decisions that address the rule have dealt with defenses, whether patent-specific (as in *Christianson*) or as a matter of general federal law. See *Holmes Grp., Inc. v. Vornado Air Circulation Sys., Inc.*, 535 U.S. 826, 831 (2002). In 2002, the Court clarified that whether a claim arises under an act “relating to patents” is to be determined solely on the basis of the complaint and not on any counterclaims, compulsory or otherwise. *Id.*

2.3.2.2 Supplemental Jurisdiction

The jurisdiction of federal district courts extends to state-law claims arising out of a patent dispute. A common example of such jurisdiction is a trade secrets cause of action relating to the same technology as the patent cause of action. The supplemental jurisdiction statute provides that “in any civil action of which the district courts have original jurisdiction, the district courts shall have supplemental jurisdiction over all other claims that . . . form part of the same case or controversy under Article III of the United States Constitution.” 28 U.S.C. § 1367(a). Accordingly, if a district court has no

underlying original jurisdiction (e.g., the plaintiff lacks standing to bring any federal claims), the supplemental state-law claims must be dismissed. *Textile Prods., Inc. v. Mead Corp.*, 134 F.3d 1481, 1485–86 (Fed. Cir. 1998). However, the district courts have discretionary authority to retain supplemental jurisdiction over state-law claims even when the federal claims giving rise to original jurisdiction have been dismissed on the merits. 28 U.S.C. § 1367(c); *Gaia Techs., Inc. v. Reconversion Techs., Inc.*, 104 F.3d 1296, 1297 (Fed. Cir. 1996) (citing *Baker v. Farmers Elec. Coop., Inc.*, 34 F.3d 274, 283 (5th Cir. 1994)), amending 93 F.3d 774, 781 (Fed. Cir. 1996).

2.3.3 Venue

Venue for patent cases is generally governed by 28 U.S.C. § 1391, permitting filing in any district in which infringing activity (broadly defined as making, selling, or offering for sale) has occurred.

2.3.3.1 Venue Transfer Motions

Because most patent cases involve products or services available nationally, the patent venue statute generally permits a plaintiff to bring suit in any district. Accordingly, defendants are often sued for infringement in a district in which they have no physical presence, and will often respond with a motion to transfer venue.

“For the convenience of parties and witnesses, in the interest of justice, a district court may transfer any civil action to any other district or division where it might have been brought.” 28 U.S.C. § 1404(a). Federal Rule of Civil Procedure 72(a) requires that district courts “promptly conduct” venue transfer proceedings. *See In re EMC Corp.*, 501 F. App’x 973, 975, 976 (Fed. Cir. 2013) (stressing “the importance of addressing motions to transfer at the outset of litigation”); *see also In re Google, Inc.*, 2015-138 (Fed. Cir. 2015) (granting writ of mandamus to direct a magistrate judge to stay proceedings and decide a motion to transfer that had been pending for over nine months). Furthermore, motions to transfer venue are to be decided based on “the situation which existed when suit was instituted.” *Hoffman v. Blaski*, 363 U.S. 335, 343 (1960) (quoting *Paramount Pictures, Inc. v. Rodney*, 186 F.2d 111, 119 (3d Cir. 1950) (Hastie, J., dissenting)). Thus, any familiarity that the district court has gained with the underlying litigation due to the progress of the case since the filing of the complaint is irrelevant when considering the transfer motion. *See In re EMC Corp.*, 501 F. App’x at 976.

To obtain a change of venue, the defendant must demonstrate why the forum should be changed. The difficulty of meeting that burden is the subject of some disagreement. In *Gulf Oil Corp. v. Gilbert*, a frequently cited case, the Supreme Court held that “unless the balance is strongly in favor of the defendant, the plaintiff’s choice of forum should rarely be disturbed.” 330 U.S. 501, 508 (1947), *superseded by statute*, 28 U.S.C. § 1404(a), *as recognized in Quackenbush v. Allstate Ins. Co.*, 517 U.S. 706 (1996). However, *Gilbert* is a *forum non conveniens* case, not a § 1404(a) case. In *Norwood v. Kirkpatrick*, decided after the enactment of § 1404(a), the Supreme Court held that § 1404(a)’s “words should be considered for what they say, not with preconceived limitations derived from the *forum non conveniens* doctrine,”

and that § 1404(a) was “intended to permit courts to grant transfers upon a lesser showing of inconvenience” than that required in the *forum non conveniens* context. 349 U.S. 29, 31, 32 (1955) (internal quotations omitted). The Fifth Circuit has further examined the difference between the *forum non conveniens* doctrine (which requires dismissal of a case) and § 1404(a) (which permits only transfers), and held that “the avoidance of dismissal through § 1404(a) lessens the weight to be given” to the plaintiff’s choice of venue and that, consequently, “he who seeks the transfer must show good cause.” *Humble Oil & Ref. Co. v. Bell Marine Serv., Inc.*, 321 F.2d 53, 56 (5th Cir. 1963). Sitting en banc, the Fifth Circuit held that

to show good cause means that a moving party, in order to support its claim for a transfer, must satisfy the statutory requirements and clearly demonstrate that a transfer is “[f]or the convenience of parties and witnesses, in the interest of justice.” Thus, when the transferee venue is not clearly more convenient than the venue chosen by the plaintiff, the plaintiff’s choice should be respected. When the movant demonstrates that the transferee venue is clearly more convenient, however, it has shown good cause and the district court should therefore grant the transfer.

In re Volkswagen of Am., Inc., 545 F.3d 304, 315 (5th Cir. 2008) (en banc). The Fifth Circuit made clear that the “good cause” burden “reflects the appropriate deference to which the plaintiff’s choice of venue is entitled.” *Id.*

In determining whether to transfer venue, courts balance the convenience of the litigants and the public interest in the fair and efficient administration of justice. *Id.* The convenience factors include: (1) the relative ease of access to sources of proof; (2) the availability of the compulsory process to secure witnesses’ attendance; (3) the willing witnesses’ cost of attendance; and (4) all other practical problems that may interfere with the litigation being relatively easy, expeditious, and inexpensive. *In re TS Tech USA Corp.*, 551 F.3d 1315, 1319 (Fed. Cir. 2008) (applying Fifth Circuit law). The public factors include: (1) the administrative difficulties flowing from court congestion; (2) the local interest in having local issues decided at home; (3) the forum’s familiarity with the governing law; and (4) the avoidance of unnecessary conflict-of-law problems involving the application of foreign law. *Id.* Although courts have traditionally also considered the plaintiff’s forum choice (though that by itself was not conclusive or determinative, *In re Horseshoe Entm’t*, 337 F.3d 429, 434 (5th Cir. 2003)), the Fifth Circuit in *Volkswagen* held that the plaintiff’s forum choice was reflected in the moving party’s burden to show good cause, and that no separate consideration need be given to the plaintiff’s choice. *Volkswagen*, 545 F.3d at 315.

To correct “a patently erroneous denial of transfer,” the Federal Circuit may grant a writ of mandamus, ordering a district court to transfer a case to a different venue. *In re Acer Am. Corp.*, 626 F.3d 1252, 1254 (Fed. Cir. 2010) (ordering transfer where plaintiff and five defendants were located in transferee venue and no party was located within 300 miles of courthouse where case was filed). “The writ of mandamus is available in extraordinary situations to correct a clear abuse of discretion or usurpation of judicial power.” *In re Nintendo Co.*, 589 F.3d 1194, 1197 (Fed. Cir. 2009). In *Nintendo*, the Federal Circuit held that the district court abused its discretion “in a case featuring most witnesses and evidence closer to the transferee venue with few or no convenience factors favoring the venue chosen by the plaintiff.” *See id.* at 1198.

Similarly, the Federal Circuit has granted mandamus relief in cases reflecting a variety of factual situations, especially out of the Fifth Circuit. *See, e.g., In re Microsoft Corp.*, 630 F.3d 1361 (Fed. Cir. 2011) (ordering transfer where U.K. plaintiff incorporated affiliate and established office without employees in Tyler, Texas, sixteen days before filing suit there); *In re Zimmer Holdings, Inc.*, 609 F.3d 1378, 1381 (Fed. Cir. 2010) (ordering transfer out of the Eastern District of Texas where “plaintiff is attempting to game the system by artificially seeking to establish venue by sharing office space with another of the trial counsel’s clients”); *In re Hoffman–La Roche Inc.*, 587 F.3d 1333 (Fed. Cir. 2009) (ordering transfer from Eastern District of Texas where plaintiff’s only connection to transferring district was storing electronic documents locally); *In re TS Tech USA Corp.*, 551 F.3d 1315, 1321 (Fed. Cir. 2008) (finding that the district court “clearly abused its discretion in denying transfer from a venue with no meaningful ties to the case”); *but cf. In re Apple Inc.*, 743 F.3d 1377, 1379 (Fed. Cir. 2014) (divided panel denied writ of mandamus seeking relief from Eastern District of Texas order denying transfer); *In re ASUS Comput. Int’l*, 537 F. App’x 928 (Fed. Cir. Sept. 11, 2014) (denying writ of mandamus, explaining that “[t]he clear abuse of discretion standard means that the district court has a ‘range of choice’ and that its decision will be upheld so long as it stays within reason.” (quoting *In re Vistaprint Ltd.*, 628 F.3d 1342, 1347 (Fed. Cir. 2010))).

Notably, in applying Fifth Circuit law in these cases, the Federal Circuit held that the plaintiff’s choice of forum need only be honored to the extent the plaintiff’s connections to the forum are legitimate, rather than connections “made in anticipation of litigation and for the likely purpose of making that forum appear convenient.” *See In re Microsoft Corp.*, 630 F.3d at 1361, 1364 (Fed. Cir. 2011); *see also In re Toyota Motor Corp.*, 474 F.3d 1338, 1340 (Fed. Cir. 2014) (applying Fifth Circuit law in affirming district court’s transfer order, which found that the plaintiff’s recent opening of an office in the district court’s jurisdiction did not favor retention); *In re Nintendo*, 756 F.3d 1363 (Fed. Cir. 2014) (affirming Eastern District of Texas order denying transfer, noting that “decisions granting transfer have looked beyond the connection of the parties with the transferor venue when the disparity of convenience is so marked as to outweigh the plaintiff’s right to choose the forum.”). District courts beyond the Fifth Circuit have cited this rule to justify increased scrutiny of the plaintiffs’ chosen forum. *See, e.g., Pragmatius AV, LLC v. Facebook, Inc.*, 769 F. Supp. 2d 991, 997 (E.D. Va. 2011) (citing *In re Microsoft* for the proposition that, for the plaintiff’s choice to warrant substantial deference in the venue analysis, “[the] plaintiff must prove a legitimate connection to the district”) (criticizing plaintiffs for selecting forum because of its reputation as a “rocket docket”).

Another reason the Federal Circuit has ordered transfer is that “[i]n patent infringement cases, the bulk of the relevant evidence usually comes from the accused infringer. Consequently, the place where the defendant’s documents are kept weighs in favor of transfer to that location.” *In re Genentech, Inc.*, 566 F.3d 1338, 1345 (Fed. Cir. 2009) (quoting *Neil Bros. Ltd. v. World Wide Lines, Inc.*, 425 F. Supp. 2d 325, 330 (E.D.N.Y. 2006)); *but see In re Barnes & Noble, Inc.*, 743 F.3d 1381 (Fed. Cir. 2014) (divided panel denied writ of mandamus seeking relief from order refusing to transfer case even though party and nonparty witnesses resided in the transferee district be-

cause the movant failed to address how many such witnesses would be unavailable or unwilling to testify in the transferor district and other factors favored the transferor district). In addition, the Federal Circuit has played down the role of the defendant’s place of incorporation, overturning a District of Delaware ruling that the defendant’s nominal corporate domicile tipped the balance in favor of retaining venue in Delaware. See *In re Link_A_Media Devices Corp.*, 662 F.3d 1221 (Fed. Cir. 2011).

Nonetheless, the Federal Circuit has denied mandamus where remaining in a particular venue would significantly serve judicial economy. See *In re Vistaprint, Ltd.*, 628 F.3d 1452 (Fed. Cir. 2010) (denying writ of mandamus for transfer where there was past and co-pending litigation in the same court on the patent in suit); *In re Volkswagen of Am., Inc.*, 566 F.3d 1349 (Fed. Cir. 2009) (denying transfer where three lawsuits were pending in the same court on the same patents); but see *In re Verizon Bus. Network Servs.*, 635 F.3d 559 (Fed. Cir. 2011) (ordering transfer where convenience factors clearly outweighed the possible judicial efficiencies to be gained because the patent-in-suit had been previously construed by the same court in a separate action five years earlier, and prior to a reexamination proceeding).

Despite these denials of mandamus, recent writs issued by the Federal Circuit regarding transfer motions have made clear that certain facts, without more, are inadequate to maintain venue in a forum if there is another forum that is more convenient to witnesses in the action. For example, until recently, some district courts denied transfer on the ground that the forum was a centralized locale between many far-flung witnesses and documents. The Federal Circuit has rejected this rationale for maintaining venue. See *In re Genentech, Inc.*, 566 F.3d at 1348; *In re Nintendo Co.*, 589 F.3d 1194, 1199–1200 (Fed. Cir. 2009). Table 2.4 summarizes factual showings deemed insufficient to maintain venue.

Table 2.4
Facts, Standing Alone, Held Insufficient to Maintain Venue

District court deference to plaintiff’s choice of forum.	<i>In re Nintendo</i> , 756 F.3d 1363 (Fed. Cir. 2014) <i>In re TS Tech USA Corp.</i> , 551 F.3d 1315 (Fed. Cir. 2008)
Presence of electronic documents in the forum.	<i>In re Hoffmann–La Roche Inc.</i> , 587 F.3d 1333 (Fed. Cir. 2009)
Plaintiff’s presence in the venue was solely for purposes of litigation. For example: Incorporating in the venue 16 days prior to filing suit. Sharing office space in the forum with another client of trial counsel.	<i>In re Toyota Motor Corp.</i> , 474 F.3d 1338 (Fed. Cir. 2014) <i>In re Microsoft Corp.</i> , 630 F.3d 1361 (Fed. Cir. 2011) <i>In re Zimmer Holdings, Inc.</i> , 609 F.3d 1378 (Fed. Cir. 2010)
Past experience of the transferee forum with the patent in suit.	<i>In re Verizon Bus. Network Servs.</i> , 635 F.3d 559 (Fed. Cir. 2011)
Defendant sells allegedly infringing products in the forum.	<i>In re Nintendo Co.</i> , 589 F.3d 1194 (Fed. Cir. 2009)

“Central location” rationale.	<i>In re Genentech, Inc.</i> , 566 F.3d 1338 (Fed. Cir. 2009) <i>In re Nintendo Co.</i> , 589 F.3d 1194 (Fed. Cir. 2009)
Defendant is incorporated in the forum but maintains no other business presence there.	<i>In re Link_A_Media Devices Corp.</i> , 662 F.3d 1221 (Fed. Cir. 2011)

2.3.4 Multidistrict Coordination

There are a number of options for managing multiple patent cases between the same parties or involving the same patents. This issue takes on greater significance in the aftermath of the AIA’s misjoinder provision. See § 2.2.2.1.1. Multiple cases pending in the same district are often consolidated (or at least coordinated) before a single judge. See § 5.1.3.8 (discussing claim construction in multidefendant cases). Related cases pending in multiple districts can be consolidated by a transfer of venue under 28 U.S.C. § 1404(a). In addition, the United States Judicial Panel on Multidistrict Litigation (“JPML”) is authorized to transfer cases for coordinated or consolidated pretrial proceedings if transfer “will be for the convenience of the parties and witnesses and promote the just and efficient conduct of such actions.” 28 U.S.C. § 1407.

Co-pending patent cases are eligible for coordination or consolidation through this process. For example, the JPML issued an order transferring seven patent actions relating to a patent on a system for spraying self-tanning solutions then pending in various districts for coordinated or consolidated pretrial proceedings. See *In re Laughlin Prods., Inc., Patent Litig.*, 265 F. Supp. 2d 525 (E.D. Pa. 2003). In *In re Bear Creek Techs., Inc.*, 858 F. Supp. 2d 1375 (2012) (MDL No. 2344), the JPML ruled that § 299(a) of the AIA does not alter its authority to order pretrial centralization of patent litigation. The JPML reasoned that there was “no overlap” between the AIA and § 1407, because of the different standards of the two statutes. It contrasted the AIA’s focus on joinder and consolidation at trial with “Section 1407’s express focus on transfer for pretrial proceedings.” The JPML concluded that transfer and centralization was appropriate in *Bear Creek* because the separate actions shared “substantial background questions of fact” concerning the “validity and enforceability” of the patent-in-suit, as well as “claim construction.” The JPML emphasized that “centralization offers substantial savings in terms of judicial economy by having a single judge become acquainted with the complex patented technology and construing the patent in a consistent fashion (as opposed to having six judges separately decide such issues).” When related cases or litigation between the same parties cannot be consolidated, district courts still have many available options to coordinate proceedings. Courts may designate one case as the “lead case,” or even stay a case until the conclusion of another. Judges may conduct joint hearings or conferences, or jointly appoint special masters under Federal Rule of Civil Procedure 53. The parties may be required to prepare a joint discovery plan, and protective orders can be drafted to make discovery from one case available in another.

2.4 Scheduling

As in any litigation, the case-management conference and scheduling order under Federal Rule of Civil Procedure 26(f) and 16(b) form the starting point for managing the litigation. Scheduling and case management in a patent case must balance the need for efficient identification and resolution of key issues against the dangers of insufficiently comprehending those possibly complex, highly technical issues. As discussed above, in § 2.1, patent local rules adopted in some district courts reflect various approaches to striking this balance. Courts outside these districts should consider whether such rules can be adapted to the needs of a specific case, if not a standing order.

Regardless of any patent local rules, scheduling will be optimized if the scheduling order includes dates for:

- disclosure of invalidity and infringement contentions,
- last date to disclose intention to rely on advice of counsel as a defense,
- last date to add inequitable conduct allegations without leave of court,
- close of fact discovery,
- claim-construction hearing date,
- close of expert discovery,
- last date for filing and hearing dispositive motions (in most patent cases, both sides will want to file multiple summary judgment motions; *see* §§ 2.1.3.2.4 and 5.1),
- schedule for *Daubert* motions (*see* § 7.4.2),
- the possibility of staggering expert report deadlines with damages reports due before technical expert reports,
- requiring substantial disclosure of damages theories in initial disclosures (*see* §§ 2.6.4, 4.2.1), and
- setting an early date for motions to dismiss that would narrow the scope of the action (*see* § 6.1.3).

Case-specific factors will drive decisions regarding the time necessary to complete each of the above tasks. At the outset of the case, the parties will be more familiar with these unique factors. Therefore, to facilitate preparation of an effective case-management order, the court should ask the parties to address each of these issues and to provide a proposed calendar in their Rule 26(f) Joint Case Management Statement.

2.5 Case-Management Conference

Effective management of a patent case usually begins with a case-management conference pursuant to Rule 26(f). At the conference, the court and parties identify issues relating to the substance of the case and any business considerations that influence the dispute. The court should also establish ground rules that will encourage the parties to minimize acrimony and maximize communication and compromise.

In many districts, the conference is held off the record, with only counsel in attendance. Informality can promote more productive discussion and compromise. In particularly complex or obviously contentious cases, it may be necessary to conduct the proceedings on the record.

In advance of the initial conference, many courts will issue a form of standing order that applies to patent cases, addressing the matters to be covered in the Joint Case Management Statement, the agenda for the conference, certain aspects of local patent rules and attendant disclosures, and presumptive limitations on discovery.

Some courts have found it helpful in patent cases to distribute a very brief “advisory” document to address some of the special aspects of patent litigation, as well as expectations for conduct of the case, beyond what might be found in a typical standing order or local rules. This advisory document may be distributed at, or in advance of, the initial case-management conference. Appendices 2.3 and 2.4 contain examples. The court might consider in appropriate cases requiring that lead counsel provide a copy of this advisory to their respective clients.

The following charts identify subjects for initial and subsequent case-management conferences that guide preparations for discussing the case with counsel. Appendices 2.1 and 2.2a present this material as checklists that can be provided to the parties. Exploring these issues will provide insight into how counsel might be expected to conduct the litigation and whether the case is amenable to early settlement or summary judgment.

**Table 2.5
Business and Market Considerations Checklist**

Issue	Implications
What are the accused products?	Damages. Why certain terms are being disputed in claim construction and the effect of a given interpretation. This information may also affect the scope of discovery.
Do the accused products encompass the accused infringer’s entire business, or are they part of a larger line of products?	Can be a factor in injunctions and stays: business-destroying judgments favor stays of execution.
How big is the market for these products (approximate annual sales figures)?	Willingness to litigate to trial. Justification for imposing private costs such as special masters.
Does the plaintiff make a competing product?	Relevant to consideration of injunctive relief. Can complicate damages because of plaintiff’s loss of monopoly pricing.
Are there other competitors in the market?	Issue preclusion or stare decisis possible if patent owner loses. Damages affected if economic substitutes available.

Issue	Implications
Have the parties had a prior business relationship? If so, how and when did it end?	Partners who have a history together, or an ongoing relationship, are more amenable to settlement. May be helpful in understanding collateral motivations to sue, and possible avenues to settlement.
What is the financial state of the parties (e.g., what were the companies' prior-year profits and what are projected profits)?	See above.
Are the parties public companies?	See above.
Will injunctive relief put the accused infringer out of business?	See above.
How much time remains before the asserted patents expire?	Can affect equitable factors in injunctions and stays.

Table 2.6
Substantive Considerations Checklist

Issue	Implications
Is the party asserting the patent(s) the named inventor? If not, how did the party acquire the patent rights? If by license or assignment, when did this occur?	Standing.
Is there parallel litigation (e.g., ITC) or review at the PTAB?	Stay pending resolution of related actions.
Is there a dispute about the structure and function of the accused device?	If these points are undisputed, then infringement is effectively a question of claim construction, and the case may be handled on a more expedited basis.
Is the technology complex?	The court might require a tutorial or consider appointment of a special master or technical advisor.
Are there substantive issues amenable to early resolution (e.g., a few dispositive claim terms, patent eligibility)?	Narrowing the disputed issues early in the case can focus discovery and encourage settlement; timing of resolution; need for tutorial.
Have the asserted patents—or any related patents—been litigated in actions against other parties? If so, what was the outcome?	Other case discovery may be helpful to efficient handling of current litigation. Successful prior assertion of patent can affect validity analysis. Understanding how other courts handled claim-construction or summary judgment issues can be helpful, whether or not any decisions were final, vacated, or binding in the current case.

Issue	Implications
Have the asserted patents—or any related patents—been licensed to third parties? If so, is defendant asserting a license defense or patent exhaustion?	Patent owner’s licensing activities can affect damages and consideration of injunctive relief.
Are the asserted patents connected with any industry standard? Are the asserted patents subject to a binding obligation to license?	Patent owner’s participation in standard-setting organizations may affect damages and consideration of injunctive relief, as SSOs often impose patent disclosure obligations or obligations to license on fair, reasonable, non-discriminatory terms.
Have the asserted patents—or any related patents—been reexamined in the USPTO? If so, what was the outcome? If not, is this something that either party is contemplating?	Outcome of USPTO proceedings can affect scope of claims and sometimes damages. Current or planned proceedings at USPTO may be grounds for stay of litigation. <i>See</i> § 4.6.4.
If the accused infringer intends to rely on opinion of counsel with attendant waiver of attorney–client privilege, what will be the scope of the waiver?	<i>See</i> § 2.2.3.2.2. Early discussion of waiver issues may obviate postwaiver disputes over scope.
Has litigation counsel for the patentee been involved in prosecution of the patents-in-suit or related patents?	May result in need to depose trial counsel or partners. Raises issues of privilege waiver and possible disqualification.
Discuss how the court intends to address the proper role for and limitations on expert witnesses. <i>See</i> § 7.4.1.	Raising these issues early can provide valuable guidelines for the parties in preparing for trial.
If the plaintiff has asserted indirect infringement (contributory or by inducement), discuss how plaintiff intends to prove accused infringer’s required mental state.	Raising the issue early can help guide the parties to ensure that the necessary facts are developed in discovery.
How does the plaintiff expect to calculate reasonable royalty damages? Established royalty or hypothetical negotiation? Will the entire-market-value rule be applied? Are there comparable licenses?	Raising the issue early can help guide the parties to ensure that the facts necessary to support are developed in discovery.
Will any survey evidence be presented at trial (e.g., to show customer demand for the patented invention or support a damages theory based on the entire-market-value rule)?	May wish to require parties and their experts to discuss or agree on survey design before it is conducted, to save time and money and resolve admissibility problems in advance. <i>See</i> Manual for Complex Litigation, § 11.493 (4th ed. 2004); <i>see generally</i> Shari Seidman Diamond, <i>Reference Guide on Survey Research</i> , in Reference Manual on Scientific Evidence 359 (Federal Judicial Center, 3d ed. 2011).

Table 2.7
Managing Cooperation Between the Parties and the
Potential for Early Resolution

Issue	Implications
Discuss potential parallel litigation and PTAB review.	Efficiency, timing, and cost of litigation. Whether to stay litigation depends in part on whether a stay would unduly prejudice or present a clear tactical disadvantage to the nonmoving party.
Discuss the parties' anticipated scope of discovery. Consider limiting the number of depositions, document requests and/or requests for admission. Consider whether the 25-interrogatory limit under the Federal Rules should be modified.	Efficiency and cost of litigation. More robust discovery planning generally means less call on the court to intervene later in discovery disputes.
Discuss electronic discovery issues.	Encourages early cooperation in complex and costly area; diminishes risk of inadvertent loss of electronic records.
Discuss the patents and claims being asserted. Consider imposing a limit on the number of claim terms to be construed.	Helps parties focus on narrowing issues in the case, reducing the burden on themselves and the court.
Discuss whether claim construction will turn on disputed subsidiary facts.	Helps to plan for <i>Markman</i> hearing—scope of tutorial; whether to have live testimony from experts or other witnesses.
Require the parties to meet and confer (at least telephonically) before bringing discovery disputes to the court. Provide stern warnings concerning cooperation and communication.	Reduces the need for court intervention to resolve discovery disputes, which can overwhelm a case if not controlled.
Consider limiting the number of discovery disputes the court will entertain without prior leave.	See above. The court may exercise even more control by requiring leave through a telephonic hearing, either directly or preceded by a very brief exchange of letters.
If the district does not have its own patent local rules, consider adopting the patent local rules of another district (e.g., Northern District of California). Discuss with the parties ways that such patent local rules might be adapted to the case.	Improves efficiency by eliminating most common discovery disputes. Generally improves forward progress of the case and assures that claim-construction and summary judgment motions will be informed.

Issue	Implications
Discuss the timing of summary judgment motions and their relationship to claim construction, and identify any other issues that could potentially give rise to dispositive motions. If so, do these issues require much discovery?	While claim construction may or may not have to be completed before the summary judgment process (<i>see</i> § 2.1.3), other issues may be dispositive. <i>See</i> § 6.1.1 for further discussion of issues that might be amenable to early adjudication.
Discuss any restrictions that the court will or might impose on the number of summary judgment motions.	Can greatly affect the parties' strategies and practices. <i>See</i> § 6.1 for guidance on summary-adjudication best practices for patent cases.
Discuss how the court will distinguish motions for summary judgment and motions <i>in limine</i> . <i>See</i> § 7.1.4.	Reduces burden of premature consideration of <i>in limine</i> motions and tardy consideration of summary judgment motions.
Discuss approaches to mediation. Appoint mediator, or initiate selection process. <i>See</i> § 2.7.	Establishes mediation as integral and continuous part of litigation process. Encourages parties to cooperate on information exchange. Enhances chance of early resolution.

2.6 Salient Early Case-Management Issues

This section addresses issues that can greatly influence the costs and complexity of patent litigation. The goal is to identify possible issues that can potentially lead to early resolution of some or all issues and/or greatly reduce the costs of patent litigation.

2.6.1 Multidefendant Litigations

An increasingly popular trend has been for patentees to sue large numbers of defendants in a single litigation. For plaintiffs, this approach is often less expensive and easier to coordinate than pursuing multiple different litigations. The AIA and the Federal Circuit's decision in *In re EMC Corp.*, 677 F.3d 1351 (2012), are likely to blunt this trend. For example, in those multidefendant cases where the conduct or products accused of infringement bear little resemblance from one defendant to another, there may be joinder issues. *See* § 2.2.2.1.1. But other types of multidefendant cases may be unaffected by these changes in the law. For example, the alleged infringement may stem from the defendants' compliance with an industry standard, or where the patentee has sued both the manufacturer of the accused products and its downstream customers (e.g., OEM companies).

The court's ability to efficiently manage such cases may be enhanced by identifying at an early stage the patentee's basis for including multiple defendants in the litigation.

2.6.1.1 Multidefendant Litigations Based on Standards Compliance

Standards regulate almost all modern manufacturing. For example, every wireless device must conform to a wide variety of standards set by industry-specific standard-setting organizations (SSOs). These standards ensure interoperability between devices. When practicing a mandatory feature of a standard infringes a patent, however, each manufacturer's compliance with the standard becomes an act of infringement. Recently, there has been enormous growth in patent litigations accusing whole industries of patent infringement based on the practice of standards. Identifying this underlying fact at the outset of the litigation can improve the court's management of the case.

For example, if the alleged infringing activity is purely the compliance with a mandatory feature of the standard, then discovery regarding the functional specifications of the accused products can be fairly limited.

However, these types of cases almost always also involve complicated defenses and counterclaims related to the patentee's potential noncompliance with the policies of the SSO that govern the adoption of the standard. For example, the defendant may bring claims or defenses alleging that the patentee participated in the development of the standard without timely disclosure of its patents that were essential to the standard, in violation of SSO policies. Alternatively, the defendant may allege that the patentee has failed to offer a license on fair, reasonable, and non-discriminatory (FRAND) terms, as most SSO policies require for patents that patentees declare essential to the standard. These allegations may form the basis for equitable, contract-based, and/or antitrust claims and defenses. *See, e.g., Qualcomm Inc. v. Broadcom Corp.*, 548 F.3d 1004, 1020 (Fed. Cir. 2008) (holding patent unenforceable for implied waiver where the patentee "organiz[ed] a plan of action to shield the '104 and '767 patents from consideration by the JVT (Joint Video Team) with the anticipation that (1) the resulting H.264 standard would infringe those patents and (2) Qualcomm would then have an opportunity to be an indispensable licensor to anyone in the world seeking to produce an H.264 compliant product."); *Broadcom Corp. v. Qualcomm Inc.*, 501 F.3d 297 (3d Cir. 2007) (holding that a claim for antitrust violations was stated based on a patentee's failure to offer a FRAND license). These additional claims and defenses can complicate the litigation and the scope of discovery.

Another consideration is that the defendants in these litigations are often competitors in the same industry (since they are all accused of practicing the same standards). Thus, confidentiality may be a significant consideration for certain issues, especially damages. This type of litigation lends itself well to bifurcating damages from liability, since the parties will likely share infringement and invalidity positions, but may vary on damages.

2.6.1.2 Customer/Manufacturer Multidefendant Litigations

To gain leverage over a manufacturer defendant, a patentee might join or separately sue the customers (e.g., OEM companies, distributors/resellers, etc.) of the

manufacturer's allegedly infringing products. Because the manufacturer may be jointly and severally liable with the customers for the damages flowing from the infringement, these customers are generally superfluous to the litigation. Often, the court will stay the cases against the customer defendants pending the resolution of the litigation against the manufacturer defendants to decrease litigation costs and to streamline the case.

In a case involving only customer defendants, the parties will likely need to take third-party discovery from the manufacturers of the accused product to prove or defend against infringement. Such discovery can be difficult and time consuming, and may raise complicated protective-order issues. A lack of access to the details of the accused third-party technology may inhibit a defendant's ability to adduce evidence of and develop contentions for its noninfringement theory. The court should be cognizant of these discovery complications in a case involving only customer defendants.

Under Federal Rule of Civil Procedure 42(b), a district court can hold separate trials on various issues or claims "for convenience, to avoid prejudice, or to expedite and economize." In cases involving both customers and manufacturer defendants, manufacturer defendants may seek to stay the proceeding as to the customer defendants when the claims against customer defendants are merely peripheral to the main claim. The court will stay the cases against the customer defendants, sometimes subject to consent from the customer defendants to be bound by the judgment against the manufacturer defendant.

In a case involving only customer defendants, a manufacturer that wishes to protect its customers may adopt one of two approaches: (1) to seek leave from the court to intervene in the suits against the customers or (2) to file a declaratory judgment action of noninfringement in another forum. Under the former circumstance, courts frequently grant leave to intervene. Under the latter circumstance, the original plaintiff may seek to stay, dismiss or transfer the manufacturer defendant's declaratory judgment action based on the first-to-file rule. See *Futurewei Techs., Inc. v. Acacia Research Corp.*, 737 F.3d 704, 708 (Fed. Cir. 2013). A manufacturer defendant, on the other hand, may invoke the "consumer suit exception" and seek an injunction from the court presiding over its declaratory judgment action to enjoin the original plaintiff from prosecuting the customer suits. The determination under the first-to-file rule and the "consumer suit exception" often turns on the consideration of judicial efficiency, including whether "the issues and parties are such that the disposition of one case would be dispositive of the other." See, e.g., *Proofpoint, Inc. v. InNova Patent Licensing, LLC*, 2011 U.S. Dist. LEXIS 120343, 2011 WL 4915847, at *7 n.5 (N.D. Cal. Oct. 17, 2011) (citing *Katz v. Siegler*, 909 F.2d 1459, 1463 (Fed. Cir. 1990)); *Contentguard Holdings, Inc. v. Google, Inc.*, 2014 U.S. Dist. LEXIS 51676, 2014 WL 1477670 (E.D. Tex. Apr. 15, 2014); see also Brian J. Love & James C. Yoon, *Expanding Patent Law's Customer Suit Exception*, 93 B.U. L. Rev. 1605 (2013) (proposing "resurrecting and expanding a forgotten patent law doctrine known as the 'customer suit exception,' which allows courts to stay patent suits filed against 'customer' defendants pending the outcome of litigation between the patentee and the accused technology's manufacturer").

2.6.2 Spoliation

Because of the potential penalties if a court finds that documents have been destroyed, the issue of spoliation and, specifically, whether the parties have taken reasonable steps to preserve relevant evidence often becomes a satellite litigation to the primary patent litigation. This issue is particularly prevalent where the plaintiff is a nonpracticing entity, who may have few documents to preserve and produce,¹⁰ and the defendant is a large company with many documents that are potentially relevant to the litigation. Addressing this issue early in the litigation may allow the court to curb the issue before it consumes the court's time and the parties' resources. Section 4.4.2.1 discusses analyzing accusations of spoliation as the case progresses.

2.6.3 Early Claim Construction

Faced with the growing number of cases with tens (or hundreds) of defendants, some courts have taken an active case-management role by requiring the parties to identify claim terms, which if construed, they believe will dispose of all or a significant portion of the case. The court then proceeds to construe those claim terms on an expedited schedule. In some cases, the court orders parties to submit their claim-construction briefing via shorter than normal briefs and without any expert discovery. In the Eastern District of Texas, this approach has encouraged early resolution where it appears that the plaintiff only wants nuisance settlement values. *See, e.g., Glob. Sessions LP v. Travelocity.com, LP et al.*, 2011 U.S. Dist. LEXIS 155901 (E.D. Tex. Aug. 18, 2011).

10. An NPE that has an established licensing campaign and/or past history of litigation may have many documents that it has a duty to preserve. *See, e.g., Micron Tech., Inc. v. Rambus Inc.*, 645 F.3d 1311, 1315–19 (Fed. Cir. 2011) (finding spoliation on behalf of a non-practicing entity).

Table 2.8
Issues Susceptible to Early Motions to Dismiss or Summary Judgment

Issue	Implications
Inequitable conduct defenses	See discussion of inequitable conduct at § 2.2.3.3.2.1. The standards set by the Federal Circuit in <i>Exergen Corp. v. Wal-Mart Stores, Inc.</i> , 575 F.3d 1312 (Fed. Cir. 2009) (pleading requirements), and <i>Therasense, Inc. v. Becton, Dickinson & Co.</i> , 649 F.3d 1276 (Fed. Cir. 2011) (proof of materiality and intent), will render this defense susceptible to an early motion to dismiss. If this issue is eliminated at an early stage, discovery will be narrowed (sometimes significantly).
Patentable subject matter	See discussion of § 101 of the Patent Act at § 6.2.1.1.1.
Extraterritoriality	It is increasingly common for plaintiffs to accuse acts committed abroad of infringement of U.S. patent law under either § 271(f) or § 271(g), either alone or in combination with § 271(b). Often, there are easily ascertainable facts regarding the contacts of the defendants with the United States that could lead to early resolution of claims or defenses on the basis of extraterritorial conduct.
Willfulness	Because “culpability is generally measured against the knowledge of the actor at the time of the challenged conduct,” <i>Halo Elecs., Inc. v. Pulse Elecs., Inc.</i> , 579 U.S. ____ (2016), there may be evidence that can be produced early in the litigation that demonstrates no willful infringement (e.g., lack of pre-suit knowledge of the patent).
Is this a multidefendant litigation where the infringement theory is based on the defendants’ compliance with certain industry standards? See § 2.6.1.1.	The court can sometimes significantly narrow the scope of fact discovery since infringement will largely rise and fall based on whether the standard infringes and whether the defendants assert that they comply with the standard.
Is this a multidefendant litigation where some of the defendants are customers accused of selling infringing products, and other of the defendants are manufacturers accused of making those same products? See § 2.6.1.2.	It may be possible to stay the cases against the customer defendants and allow the case to proceed against the manufacturer, who will be joint and severally liable with each of its customers.
Is this a multidefendant litigation that is not based on compliance with standards?	Case-management efficiency considerations may counsel in favor of breaking up the case into multiple cases based on similarity of accused products or relationships between the defendants.

2.6.4 Patentable Subject Matter

The Supreme Court's decisions in *Bilski v. Kappos*, 561 U.S. 593 (2010), *Mayo Collaborative Services v. Prometheus Laboratories, Inc.*, 132 S. Ct. 1289 (2012), *Association for Molecular Pathology v. Myriad Genetics, Inc.*, 133 S. Ct. 2107 (2013), and *Alice Corp. Pty. Ltd. v. CLS Bank International*, 134 S. Ct. 2347 (2014), have invigorated patent eligibility limitations. See § 14.3.1.2.5. Since most extant patents were drafted and issued prior to these decisions, there has been a substantial rise in the number of motions to dismiss and seek summary judgment on patent eligibility grounds. Many of these cases have involved allegedly abstract business methods and diagnostic methods allegedly lacking inventive application of a law of nature. The courts have characterized patent eligibility as a question of law, which implies that patent eligibility could potentially be resolved through a motion to dismiss or summary judgment. See, e.g., *buySAFE, Inc. v. Google, Inc.*, 765 F.3d 1350 (Fed. Cir. 2014) (affirming grant of defendant's motion for judgment on the pleadings under Rule 12(c), concluding that asserted claims were not patent eligible); see also *Mayo Collaborative Servs.*, 132 S. Ct. at 1304 (rejecting government's suggestion to "substitute §§ 102, 103, and 112 inquiries for the better established inquiry under § 101").

Notwithstanding these indications that patent eligibility can be addressed early in cases involving simple business methods or broad claims to laws of nature or physical phenomena, it remains to be seen how courts will apply the "abstract ideas" and "inventive application" doctrines to more complex inventions. See § 14.3.1.3. District judges will need to understand the claimed invention, which could involve claim construction as well as learning the background science and technology. Disputes over scientific theories and what is an inventive, as opposed to a routine or conventional, application of scientific principles could well involve subsidiary factual determinations. It is unclear to what extent factual disputes surrounding these issues should be left to the jury. Cf. *Teva Pharms.*, 135 S. Ct. 831 (2015); *Markman*, 517 U.S. 370 (1996). At a minimum, the court might want to await discovery and a tutorial on the background science and technology before addressing complex patent eligibility questions.

2.6.5 Early Motions to Dismiss Indirect Infringement and Willfulness Claims

Indirect infringement and willfulness both require that the accused infringer knew of the asserted patents at the time of the infringement. Indirect infringement is also predicated on an act of direct infringement. See § 14.4.1.3. Claims of indirect infringement and willfulness, therefore, are susceptible to early determination, particularly in cases where there is evidence that the accused infringer did not know of the asserted patents before the suit was filed.

Indirect infringement claims frequently arise in cases involving patents with method claims. In these cases, a patentee's only practical cause of action will often be for indirect infringement against the manufacturer of a product alleged to practice the method claim. In these circumstances, there are numerous ways in which a court

can surface early case-dispositive weaknesses. For example, if no single entity is responsible for the performance of each step of the claim, it may be fatal to the patentee's case. *Limelight Networks, Inc. v. Akamai Techs., Inc.*, 134 S. Ct. 2111 (2014). Alternatively, if the accused product is capable of many noninfringing uses and the manufacturer exerts no control over its customers, the claim will likely fail. Although the Federal Circuit has held that a method claim can be infringed where multiple parties combine to perform the claimed steps "if one party exercises 'control or direction' over the entire process such that every step is attributable to the controlling party, i.e., the 'mastermind,'" see *Muniauction, Inc. v. Thomson Corp.*, 532 F.3d 1318, 1329 (Fed. Cir. 2008), such "control or direction" requires a "principal-agent relationship or like contractual relationship." *Aristocrat Techs. Austral. Pty. Ltd. v. Int'l Game Tech.*, 709 F.3d 1348, 1363 (Fed. Cir. 2013).

2.6.6 Damages Theories and Proof

The damages-related aspects of patent infringement cases present special case-management challenges for the district court. In large part, this results from the fact that damages law is evolving rapidly in ways that alter or render obsolete methodologies for valuing patent damages (albeit often under protest from one of the parties). See § 14.4.3.2.1.4.1. It also results from the fact that the parties in most cases do not focus the same energy on damages that they do on liability issues, in part because districts that require comprehensive liability disclosures do not require them for damages. Another factor is that expert testimony concerning damages, unlike the typical expert opinion on patent liability issues, implicates and can draw from economic, mathematical, and financial valuation methodologies that are peer-reviewed and testable, as well as industry experience in patent valuation in the licensing and acquisition context. The interplay between this body of established non-patent-litigation valuation methodologies and the *Georgia-Pacific* factors commonly used to calculate damages in patent cases creates myriad disputes about the reliability of that testimony.

As a result of these and other factors, many patent cases involve challenges to the damages theories and evidence presented by one or both of the parties. This usually occurs in the context of *Daubert* challenges to damages-related expert testimony. See § 7.4. District courts have struggled to resolve disputes about whether the methodology used by a damages expert to reach his or her conclusions is both legally viable and reliable, or whether he or she applied that methodology reliably to the facts of the case before trial. Although courts have the tools to resolve such disputes early, they are rarely raised before the pretrial stage. As a result, a court that believes that a damages expert's opinions may not be reliable usually faces imperfect options: (1) excluding the expert and leaving the party with no expert testimony regarding damages at trial; (2) continuing the trial date and providing the party proffering the expert a do-over; or (3) allowing the testimony, despite its reservations, with the belief that the jury will see the weakness in the opinions and the intent that, if not, the court will correct the outcome through remittitur, JMOL, or a motion for new trial. See, e.g., *Intellectual Ventures I LLC v. Xilinx, Inc.*, 2014 U.S. Dist. LEXIS 54900, 2014 WL 1573542 (D. Del. Apr. 21, 2014) (refusing to allow patentee's expert to revise his

report after determining the report was unreliable, forcing the patentee to rely on the defendant's expert testimony instead); *Golden Bridge Tech. Inc. v. Apple, Inc.*, 2014 U.S. Dist. LEXIS 67238, 2014 WL 1928977 (N.D. Cal. May 14, 2014) (striking damages expert's report but permitting a do-over on the eve of trial); *Golden Bridge Tech. Inc. v. Apple, Inc.*, 2014 U.S. Dist. LEXIS 76339, 2014 WL 4057187 (N.D. Cal. June 1, 2014) (striking damages expert's do-over report and denying a second do-over, as trial had begun).

Section 7.4.2 suggests effective ways to reduce the likelihood that fundamental disputes about damages theories and evidence are relegated to the eve of trial. Resolving such disputes about damages earlier in the case is difficult, in large part because the parties do not vet damages contentions as thoroughly as infringement and validity contentions. Under Federal Rule of Civil Procedure 26(a)(1)(3), a party claiming damages must provide as part of its initial disclosures "a computation of each category of damages claimed" and produce the documents and materials on which each computation is based. However, courts have not used this provision to compel a meaningful, early disclosure of the amount of damages claimed or the method by which they are computed in patent cases, apparently believing that claim construction and some damages discovery is necessary before a meaningful disclosure can fairly be compelled. See § 4.2.2. The parties usually exchange infringement and invalidity contentions during fact discovery, either in accordance with local rules or through interrogatory responses, which ensures that both parties are aware of the theories of infringement and invalidity in the early to middle stages of the case. By contrast, the parties' first disclosure of damages theories typically comes through the exchange of expert reports served after the close of fact discovery and concurrently with expert reports regarding infringement and invalidity. This creates two problems. First, because parties have not yet taken positions about damages, they cannot raise with the court in the early or middle portions of a case potential legal flaws or other issues that may render an expert opinion unreliable, as is commonly done with respect to disputes about infringement and invalidity theories. Second, *Daubert* challenges are necessarily relegated to the end of the case.

Recognizing this systemic problem, courts have begun experimenting with various mechanisms to encourage proper vetting of damages positions and opinions earlier in the case schedule. Here are several options:

Damages contentions. In jurisdictions that presently require parties to exchange infringement and invalidity contentions, the patentee could be required to provide damages contentions that (1) identify the type of damages sought (lost profits, reasonable royalty, or both); (2) provide an explanation of the specific theories and methodologies the patentee intends to use to value the infringement for which damages are sought; and (3) identify a range within which its ultimate damages number for each accused instrumentality is expected to fall. To enable the patentee to provide this information reliably, the accused infringer could be required to produce, along with its invalidity contentions, financial documents related to the accused instrumentalities (just as it is presently required to produce technical documentation concerning the accused instrumentalities). The patentee's deadline for serving such damages contentions could be set at a reasonable time (e.g., forty-five days) after the

accused infringer's document disclosure. Although not specifically directed to expert testimony, these disclosures would require the patentee to identify its theories early in the case, would enable the accused infringer to disclose rebuttal damages theories in response to a contention interrogatory served during fact discovery, and would put parties in a position to challenge each other's legal and factual bases for damages positions earlier in the case.

Courts have elicited damages contentions in several ways. Judge Sue Robinson (D. Del.) requires the plaintiff to identify its damages model and accused products as part of its initial disclosures. *See* Patent Scheduling Order, § 1(c)(2) (Judge Sue Robinson, Feb. 15, 2015). Judge Cathy Ann Bencivengo (S.D. Cal.) has ordered preliminary damages disclosure in one of her patent cases:

Preliminary Damages Disclosure

Plaintiff will serve on each defendant a preliminary damages disclosure with the following information, no later than May 19, 2015 . . . :

- Identifying the period for which it contends that defendant is liable for damages and the nature of the damages it will seek, lost profits and/or reasonable royalty;
- If plaintiff is seeking a reasonable royalty, in whole or as part of its damages, plaintiff will identify the royalty base to which it contends a reasonable royalty may apply and whether any apportionment would be appropriate; and
- Plaintiff will disclose and serve all license agreements it has entered into covering the patents at issue, whether entered into before or after the start of a litigation (i.e., licenses arising from settlement of litigation). The production of licenses is subject to the highest level of confidentiality (attorneys' eyes only) unless the plaintiff designates them otherwise. . . .

Case Management Order, *In re West View Research, LLC Patent Cases* (S.D. Cal. Apr. 25, 2015). Magistrate Judge Elizabeth Laporte (N.D. Cal.) encouraged the plaintiff to disclose its damages theory in answering defendants' request for additional information under Rule 26. *Eon Corp. IP Holding LLC v. Sensus USA Inc.*, 2013 U.S. Dist. LEXIS 32632, 2013 WL 3982994, *2–3 (N.D. Cal. Mar. 8, 2013). The court noted, however, that although early damages disclosure was ideal in theory, the many variables (type of defendant, product, availability of information" that courts and plaintiffs must consider in such disclosures makes their practice "challenging." Judge Laporte explained that

[c]ourts must balance competing considerations when evaluating the extent and specificity of early damages disclosures that should be made in patent cases, including: the desirability of narrowing issues at an early stage versus the disclosure of strategically sensitive information; the possibility of settlement versus the early intrusion of expensive discovery requests and disputes; and the need for early disclosures versus the need for costly expert analysis that may be premature. . . . [A]n early estimate of the order of magnitude of damages at issue (e.g., less than \$10 million; \$25 million; more than \$100 million) is important to the application of the principle of proportionality set forth in Federal Rule of Civil Procedure 26(b)(2)(C)(iii) to ascertain the burden and expense of discovery that is warranted.

Accelerated discovery schedule for damages. The court could elect to set an accelerated schedule for fact and expert discovery related to damages. For example, the court could require all damages-related discovery to be completed within two to three months before the fact-discovery deadline for other issues, and then require expert reports regarding damages to be served within a reasonable time thereafter (e.g., by applying the same gap between the close of damages discovery and service of the opening damages report as is set between the close of liability discovery and service of opening liability reports). Because it would allow the court to set a damages-related *Daubert* schedule that starts two to three months before summary judgment, this approach would provide sufficient time for the court to allow a one-time opportunity for a party whose proffered damages opinions are excluded to correct the deficiencies, if that opportunity is warranted, without moving the trial date. One notable example of an accelerated schedule for damages discovery is the so-called Track B in the Eastern District of Texas. The Track B Initial Patent Case Management Order was designed to complement the existing patent-case-management scheme (Track A). See General Order 14 – 03 General Order Regarding Track B Initial Patent Case Management Order (E.D. Tex. Feb. 25, 2014). Under Track B, the parties are required to submit a “good faith damages estimate” early in the case and are afforded significantly less discovery than under Track A. Track B, however, implements a much tighter schedule than Track A, presumably to facilitate early disclosure of infringement and invalidity contentions. Both parties can consent, or the court can order the case to be put on Track B. Table 2.9 summarizes Track B’s schedule. During this initial phase of the case, discovery is limited to five interrogatories, five requests for production, and five requests for admission per side, absent leave or stipulation.

Table 2.9
Eastern District of Texas’s Track B

Deadline	Event
14 days after answer	Patentee discloses infringement contentions and licensing disclosures.
44 days after answer	Initial disclosures and summary sales information for accused & “reasonably similar” products.
58 days after answer	Good-faith damages estimate + method of calculation.
72 days after answer	Accused infringer discloses invalidity contentions.
77 days after answer	Parties file notice of readiness for case-management conference.

Clear identification of “do-over” policy. Given the costs and time needed to prepare expert damage reports, the critical importance of such evidence to many patent cases, and the uncertainty surrounding the admissibility of damages evidence, courts should work with the parties to establish ground rules for allowing a party to rectify or substitute a damages report. Such a policy could deal with timing as well as scope.

At a minimum, such a discussion could surface the disputes that could arise and provide clues to the types of damages theories that are unlikely to be admissible and those that are. The Federal Circuit has moved away from formulaic damages theories (25% rule, Nash bargaining solution, entire market value rule) and moved toward other approaches (prior license agreements, smallest saleable patent-practicing unit as the basis for reasonable royalty calculations). Discussing how these doctrines apply to the particular facts and circumstances of the case could reduce the risks that the plaintiff will be left without a viable damages theory at the time of trial.

Early consideration of Daubert challenges and/or damages theories. Relatedly, the court could set an early schedule for consideration of *Daubert* challenges in appropriate cases. Alternatively, the court could vet the core damages theories early, leaving opportunity for narrower challenges after discovery and completion of the final expert report.

Judge Alsup's experience with early submission of an expert damages report in *Oracle America, Inc. v. Google Inc.*, however, was not regarded as a complete success. 798 F. Supp. 2d 1111, 1121–22 (N.D. Cal. 2011). Although the vetting process did not meet with his expectations, he was able to set some parameters on acceptable damages theories (foreshadowing the Federal Circuit's decision in *VirnetX, Inc. v. Cisco Sys., Inc.*, 767 F.3d 1308, 1332–34 (Fed. Cir. 2014) (questioning the Nash bargaining solution as an apportionment theory)) and warn the parties of the risks of questionable methodologies.

Bifurcation or reverse bifurcation. Depending on the circumstances and opportunities for settlement, the court could bifurcate liability and damages. See § 8.1.1.3. Trying damages first could be advantageous where the potential damages might be found to be modest and the liability issues are complex.

Independent or court-appointed damage experts. When the imprecise and speculative quality of economic methodology mixes with the polarizing nature of trial advocacy, the resulting economic testimony can be widely disparate and confusing. Courts might wish to appoint a respected and neutral expert to either present their own damages report or to comment on the reports of the parties' experts. See Fed. R. Evid. 706; J. Gregory Sidak, *Court-Appointed Neutral Economic Experts*, 9 J. Competition Law & Econ. 359 (2013) (discussing Judge Richard Posner's use of court-appointed damages expert); cf. *Gen. Elec. Co. v. Joiner*, 522 U.S. 136, 149–50 (1997) (Breyer, J., concurring) (encouraging, in a toxic torts case, the use of neutral experts to “overcome the inherent difficulty of making determinations about complicated scientific, or otherwise technical, evidence”); *In re Payment Card Interchange Fee & Merchant Discount Antitrust Litig.*, 2012 U.S. Dist. LEXIS 153637, 2012 WL 3932046 (E.D.N.Y. Mar. 19, 2013), ECF No. 1908 (Gleason, J.) (appointing a neutral economic expert to advise on “economic issues that may arise in connection with . . . final approval of a [\$7.25 billion] proposed settlement” of an antitrust class action against Visa and MasterCard”); Joe S. Cecil & Thomas E. Willging, *Court-Appointed Experts: Defining the Role of Experts Appointed Under Federal Rule of Evidence 706* (Federal Judicial Center 1993). Although it adds some additional costs and complexities at the front end of the process, such as defining the expert's role and compensation, an independent expert can solve problems that can emerge later in the

litigation. Broaching this possibility early in the case-management process could unmask lurking problems and potentially elicit creative solutions to the economic damages quandary. It also offers the court some insurance of where the parties are contemplating speculative damages theories. *But see Oracle Am., Inc. v. Google Inc.*, 2012 U.S. Dist. LEXIS 132696, 2012 WL 4017808 (N.D. Cal. Apr. 10, 2012) (striking parts of court-appointed economic expert's report).

These approaches, or others, could be utilized alone or in combination, depending on the circumstances. In some cases, none of these approaches may be practical or warranted. Even in the best circumstances, these approaches can present the court and the parties with new challenges and unintended consequences. Nonetheless, they avoid relegating damages-related disputes to the end of the case, where the court has few practical options to resolve them equitably.

As is evident from the nature of these suggestions and this discussion, there is no one-size-fits-all approach to solving this problem. But courts should, in most patent cases, discuss with the parties the timing and nature of damages discovery and the timing of damages-related *Daubert* proceedings to determine whether these or other damages-specific provisions should be adopted. Moreover, case-management techniques that clarify the parties' damages positions and the theories supporting them early in the case have the side benefit of encouraging settlement. Once parties know the damages playing field, they will be better equipped to value the risk of the litigation and evaluate settlement positions. For all of these reasons, discussing the timing and nature of damages-related disclosures and discovery at the case-management conference stage is very important. If the parties and the court do not address these issues early in the case, they will be locked into a schedule that, in almost all cases, will limit the practical options that are available to resolve damages-related *Daubert* challenges and other disputes.

2.6.7 Nuisance-Value Litigation

In recent years, patent infringement cases that appear to have been filed simply to extract a nuisance-value settlement from a large number of defendants have proliferated. Such cases, if they are not resolved quickly, have the potential to clutter the court's docket and drain resources from other cases. However, given the highly technical nature of patent cases, it can be very difficult for a court to distinguish between nuisance-value cases and cases in which both parties genuinely seek resolution of the allegations by the court or a jury. Paradoxically, recent developments in venue-transfer law by the courts, and the joinder provisions enacted by the AIA, which intended to reduce nuisance-value litigation, can make it even more difficult to identify such cases. Under the AIA, fewer defendants are likely to be aggregated in any one case or judicial district. By engaging in active case management from the outset of the case, however, courts can drive the parties in such cases toward settlement. Moreover, requiring exchanges of contentions early in the case and permitting first-track summary judgment motions (as discussed fully in Chapter 6) allows the court to resolve such cases on the merits when they do not settle and, for that reason, also promotes settlement. Requiring the parties to participate in an early ADR process

can help set the parties' expectations about the significance and costs of the case. Because these techniques are generally good practice, they do not require the court to identify and distinguish between nuisance-value cases and those with greater merit.

2.6.8 “Proportional” Scope of Discovery

On December 1, 2015, the U.S. Supreme Court adopted a number of amendments to the Federal Rules of Civil Procedure. Among these is an amendment to Rule 26(b) that limits the scope of discovery to “any nonprivileged matter that is relevant to any party’s claim or defense and proportional to the needs of the case” The “proportionality” requirement is expected to better focus courts and litigants on the expected contribution of discovery to the resolution of the case, and is intended to help achieve the “just, speedy, and inexpensive determination” of litigation. Because one factor to be considered in determining proportionality is the amount in controversy, district courts can benefit from a reasoned conversation with the parties at the first case-management conference about the scope of the case, the nature and amount of the relief sought (as mentioned in the previous sections above), and how the case compares to other patent cases, with as much specificity as is possible. This discussion can then provide a useful baseline to judge proportionality as the case progresses, with the understanding that developments in the case or information obtained in discovery may warrant revision of what further discovery is considered “proportional.”

2.7 Settlement and Mediation

The vast majority of patent cases (about 95%) settle, but often not until late in the case. In the meantime, the litigation can be extremely expensive for the parties. According to an industry survey, each side can expect to spend from \$1.7 to \$3.6 million in fees through the close of discovery, and between \$2.8 and \$5.9 million in total through trial. *See* § 1.2. Some cases can be substantially more expensive to litigate and try. Bringing the case to settlement on the eve of trial also squanders judicial and party resources. Consequently, early settlement is usually in everyone’s best interest.

Most parties to patent litigation recognize the high economic stakes, uncertainty, and legal costs involved. Nevertheless, various impediments to settlement—ranging from the relationships between the particular parties to institutional issues arising out of the nature of some patent litigation—often prevent parties from settling cases without some outside assistance.

To overcome these impediments, courts should promote dialogue between the parties and, when the circumstances allow, settle them earlier in the litigation. Early judicial intervention, usually at the first case-management conference, can be a critical factor in bringing about settlement. Such initiative by the court emphasizes to the parties that the court wants them to actively consider settlement strategies as well as litigation strategies throughout the case.

Effective judicial encouragement of settlement involves several considerations: (1) appropriate initiation of mediation; (2) selection of the mediator; (3) scheduling of mediation; (4) delineating the powers of the mediator; (5) confidentiality of the mediation process; and (6) the relationship between mediation and litigation activities. Additional considerations come into play in multiparty and multijurisdictional cases.

2.7.1 Initiation of the Mediation Process

Many courts require, either by local rules or standardized order, that counsel for the parties discuss how they will attempt to mediate the case before the first case-management conference and that they report either their agreed plan or differing positions to the court at the conference. By requiring this early discussion, the court eliminates any concern that the party first raising the possibility of settlement appears weak. This can be particularly important at the outset of a case when attitudes may be especially rigid, posturing can be most severe, and counsel may know little about the merits of their clients' positions.

Whether or not the parties have agreed on a settlement discussion strategy, the court should address the subject at the conference and encourage the litigants to develop and evolve settlement strategies along with their trial strategies. The court should make it clear that it values the mediation effort and expects that the parties will give it similar importance. Thus, the court can assure that settlement efforts receive ongoing attention as the case progresses.

At the case-management conference, the court should order the parties to meet once with a specified mediator (or a mediator to be chosen according to a specified process) prior to a fixed deadline. If either party resists mediation, the court should order participation, as it is empowered to do. *See* 28 U.S.C. § 652(a) (Supp. 1998). A party's initial insistence that it will not consent to the mediation, will attend against its will, or has no interest in compromising its rights are positions that evidence more a lack of sophistication than a strategy. Experienced mediators routinely settle cases notwithstanding claims that "this case can't be settled."

2.7.2 Selection of the Mediator

Courts can identify successful mediators for patent cases from a variety of sources: other judges and magistrate judges, retired judges, professional mediators and practicing lawyers. In some courts, the trial judge serves as mediator, but this requires the express consent of the parties. Committee on Codes of Conduct, Judicial Conference of the United States, Code of Conduct for United States Judges Canon 3A(4) (1999). Many judges decline to act in this role because they believe that it is difficult to have the requisite candid discussion with parties and their counsel and later objectively rule on the many issues the court must decide. *See Fed. Trade Comm'n v. Freecom Commc'ns, Inc.*, 401 F.3d 1192, 1208 n.9 (10th Cir. 2005) (judges in nonjury cases should be especially hesitant to involve themselves in settlement negotiations); Wayne D. Brazil, *Settling Civil Suits: Litigators' Views About Appro-*

priate Roles and Effective Techniques for Federal Judges 84–99 (1985) (noting substantial attorney discomfort with trial judge’s involvement in settlement negotiations).

The best choice is often a professional mediator with a record of successfully resolving patent litigation. A practicing patent attorney may have deeper knowledge of patent law, but that depth of knowledge, particularly in the details of patent prosecution, is unlikely to be useful in the mediation. The most useful attribute is the professional mediator’s ability to diffuse discord and build consensus between the parties. It is important that the parties have confidence that the appointment was based on the mediator’s skills and past success. Where the parties agree on a mediator, the court should usually appoint that person so that the authority of the mediator is clear.

To help judges choose mediators, some courts ask parties, attorneys, and mediators to evaluate the private mediation process confidentially at the conclusion of cases. This practice also has the advantage of putting mediators on notice that the court will monitor their performance. Forms used by the Northern District of Illinois for such an evaluation are attached as Appendices 2.4a, 2.4b, and 2.4c.

2.7.3 Scheduling the Mediation

In scheduling the first meeting with the mediator, the court should take into account the amount of time that the parties will need to become familiar with the principal issues, strengths, and weaknesses of the case as well as the risks and ramifications of the case for their businesses. Counsel typically reach this level of comprehension by the time that they file *Markman* briefs.

The mediator usually schedules the subsequent mediation sessions. The mediator has greater flexibility in arranging the meetings because, unlike a court, a mediator can consult with counsel, together or separately, to obtain their views and prepare for the next meeting.

In scheduling sessions, a mediator needs to take into account the progress of the case and how the stages of the litigation contribute to productive settlement discussions. For example, the mediator may conclude that a session should be held between briefing and hearing claim construction or summary judgment when positions are fully exposed, and the uncertainty of outcome can lead to compromise. *In limine*, *Daubert*, and other pretrial motions create similar opportunities. Substantive mediation preferably occurs before the intense and expensive period of trial preparation. Nevertheless, because many cases are settled only with the immediate uncertainty of trial, mediation efforts should continue through the pretrial process. Mediation after a jury verdict, but before the resolution of posttrial motions, can also be effective, especially in cases in which legal issues such as inequitable conduct and injunctive relief remain to be resolved.

2.7.4 Powers of the Mediator and Who Should Be Present During Mediation

To maximize the likelihood of successful mediation, the mediator must have the power to require certain actions. Most importantly, the mediator should be empowered to require, or the court should be prepared to order, that the parties participate in the mediation. Participation includes attendance by the most appropriate client representative. The common insistence that someone “with full settlement authority” attend the mediation is insufficient in patent cases because a person with authority does not necessarily have the requisite motivation to engage in meaningful compromise. For the typical corporate business entity, the person with the necessary authority and motivation may be a licensing executive; for the alleged infringer, it may be a manager of the operating unit responsible for the accused product or service whose budget will absorb the costs of the settlement and any judgment. Merely because in-house counsel oversees the litigation and has authority to settle does not mean that person is the most appropriate party representative.

The mediator may need to resolve disagreements about the relative seniority of party representatives. If litigants are of similar size, this usually is not a problem. But when one company is much smaller—for example, either a start-up competitor or a patent-holding company—it likely will be represented by its chief executive officer, and it may attempt to compel attendance of the chief executive of the larger entity. This approach can sometimes be counterproductive because it forces participation by someone who lacks sufficient knowledge and resents having to attend. It is more important that the representative of the large entity be someone with responsibility for and knowledge of the relevant portion of that entity’s business.

The mediator may also need to address how to obtain approval of a settlement when no one person has settlement authority, and any outcome must be approved by a governing board. Where an entity requires board approval of a settlement, the entity is typically represented at the mediation by an individual. If the mediation is successful, the mediator should require that the representative commit to recommend the unconditional approval of the settlement to the board and require that the board act by a fixed date.

Another important power for a mediator is the right to exclude particular individuals from the process. For example, one or more of the parties’ counsel or an individual, such as an inventor or a technical director, may be too deeply involved in the merits of the dispute to be constructive. Particularly for major cases, it can be useful to require the parties to be represented by attorneys other than lead litigation lawyers. They tend to be preoccupied with the merits and events of the litigation and sometimes find it difficult to communicate productively with each other.

2.7.5 Confidentiality of the Mediation

To maximize open communication and candor, everything submitted, said, or done during the mediation should be deemed confidential and not be available for use for any other purpose. Confidentiality is usually required by agreement of the

parties or by court order or rule. *See, e.g.*, N.D. Cal. Patent L. R. 6-11 (broadly prohibiting disclosure or use outside the mediation of anything said or done in the mediation). Generally, the confidentiality requirements go beyond the evidentiary exclusion of Federal Rule of Evidence 408 and assure that the parties, their counsel, and the mediator can candidly discuss the facts and merits of the litigation without concern that statements might be used in the litigation or publicized. Given the importance of confidentiality to the mediation process, the court should be prepared to enforce these confidentiality guarantees strictly.

This same concern for confidentiality usually precludes reports to the trial judge of anything other than procedural details about the mediation, such as the dates of mediation sessions, or a party's violation of court rules or orders requiring participation. *See* Robert Niemic, Donna Stienstra & Randall Ravitz, *Guide to Judicial Management of Cases in ADR* 111–14, 163–64 (Federal Judicial Center 2001) [hereinafter *FJC ADR Guide*] (“An attorney-neutral should protect the integrity of both the trial and ADR processes by refraining from communicating with the assigned trial judge concerning the substance of negotiations or any other confidential information learned or obtained by virtue of the ADR process, unless all of the participants agree and jointly ask the attorney-neutral to communicate in a specified way with the assigned trial judge.”); Am. Bar Ass’n, *Civil Trial Practice Standards* § 23e (2007) [hereinafter *ABA Standards*] (“The court should not communicate *ex parte* with any third-party neutral, including a senior, magistrate or other judge, involved in an alternative dispute resolution mechanism about the course of negotiations or the merits of the case.”). “Public confidence in both the trial and settlement processes can be undermined if direct communication is permitted between the attorney/neutral and the assigned trial judge regarding the merits of the case or the parties’ confidential settlement positions.” *FJC ADR Guide* at 164.

In addition to being confidential, briefing and communications relating to mediation may be privileged against discovery in future litigation. *See, e.g.*, *Sheldone v. Pa. Tpk. Comm’n*, 104 F. Supp. 2d 511, 515 (W.D. Pa. 2000).

2.7.6 Relationship of the Mediation to the Litigation Schedule

Absent a final settlement, a case usually proceeds as scheduled without regard to mediation events. *See* ABA Standards § 23(f) (2007) (“The court ordinarily should not delay proceedings or grant continuances to permit the parties to engage in settlement negotiations.”) This approach assures that the litigation is not unnecessarily delayed and encourages the parties to mediate diligently.

Arranging early discovery of needed information or scheduling early consideration of a potentially important summary judgment motion may make it possible for the parties to consider settlement earlier in the case. The patent owner, for example, may believe it needs software code, chemical formulation details, or other information not available by buying or using the infringing product or service. Alternatively, the parties may dispute the existence of an invalidating prior sale of the pa-

tented invention. This scheduling can be facilitated by the mediator at an early meeting with the parties.

Mediation is sometimes held while a critical case event is pending—for example, after the briefing and hearing of a preliminary injunction or summary judgment motion, but before the court decides the motion. In some courts, judges and mediators regularly communicate about scheduling to maximize these settlement opportunities. By providing the parties with an expected schedule for deciding the motion, the court can encourage them to focus on completing a settlement before the deadline. If the parties are productively engaged in mediation at the deadline, some judges continue to delay issuing a decision where the mediator and the parties so request.

2.7.7 Mediating Multiparty and Multijurisdictional Cases

Not all patent cases involve a single plaintiff and defendant in a single court. When in the typical multiparty case the patent owner asserts that the alleged infringers acted independently, separate mediation meetings can be scheduled for each alleged infringer. This allows the opportunity to negotiate settlements with each defendant based on the unique facts and market forces relevant to that party. It also allows the defendants interested in settling early to mediate without the interference of others who may wish to litigate the dispute through a later stage of the case.

Multijurisdictional cases often arise when a party sued on a patent brings a countersuit against the plaintiff in another court, asserting infringement of its own patent. In some circumstances, however, parties may find themselves in unrelated patent litigation in multiple courts because different business units of at least one of the parties have proceeded independently.

Settlement efforts normally should not be delayed in one court because of proceedings in another court. The parties should be required to comply with the court's usual mediation planning requirements. If the parties report active engagement in mediation in another jurisdiction, the court can delay ordering further mediation while they complete those efforts. In the mediation of multijurisdictional suits, the parties will make clear the scope of settlement they are prepared to negotiate. If the multiple cases are countersuits, cases in both courts will be settled. If the separate suits are the result of the independent actions of separate business units, one party may assert that the second suit will not be part of any settlement. Should its opponent disagree, the mediator will have to decide whether to force the discussion of the second suit—likely requiring the attendance of party representatives of the second business unit—or focus the discussions on the single case.

2.7.8 Factors Affecting the Likelihood of Settlement of Particular Categories of Cases

Like other aspects of patent litigation, settlement dynamics vary with the nature of the parties. While every case involves a multitude of individual settlement issues, categories of cases also reflect common traits and pathologies. The following chart summarizes the settlement issues and patterns associated with the most common

types of patent disputes and provides insights into how and when settlement can be most effectively fostered:

Table 2.10
Settlement Considerations

Case Category	Settlement Issues
Competitor vs. Competitor—Core Technology	Difficult to settle absent a counterclaim or other significant risk to the patent owner or strategic opportunity available from business agreement. Meaningful mediation likely to require participation from senior officers of the parties. Agreement may present antitrust issues if the parties have large cumulative market share.
Competitor vs. Competitor—Noncore Technology	Likely to settle through mediation, potentially early in the litigation. Litigation may be the result of failed effort to negotiate license prior to litigation, with litigation intended to add additional negotiating leverage.
Large Enterprise vs. Start-Up/New Entrant	If no other competitor offers substantial equivalents of claimed patented technology, the established company may not settle without eliminating start-up's use of technology. The suit nevertheless may raise costs for the start-up to the point of forcing a settlement, potentially including acquisition of the start-up. If other competitors exist, settlement is likely, potentially early in litigation. Suit may be timed to critical event for start-up (e.g., new product offering, additional investment, public stock offering, or merger), in which case potential windows for settlement are very early in the litigation or just after the event.

Case Category	Settlement Issues
Licensing Company vs. Large Enterprise	<p>The likelihood and timing of settlement depends on several factors:</p> <p>(1) the amount demanded—for example, the licensing company may intend future litigation against others and is seeking to build necessary funding through the current suit, in which case the demand may be modest and early settlement possible;</p> <p>(2) the size of the licensing company’s portfolio—if the current suit likely is the first of several expected, a license to the patentee’s entire portfolio can be an attractive settlement;</p> <p>(3) reputational effects: whether the large enterprise had or expects litigation with the patent owner or other licensing companies—several large companies believe, sometimes based on policy, that settling such suits encourages additional licensing company litigation, in which case settlement may not be possible until substantive rulings create a substantial risk of an adverse outcome for one of the parties or the enterprise has achieved its reputational goals; and</p> <p>(4) strategic alliances: whether the licensing company and large enterprise can join forces against the defendant’s competitors—a settlement, potentially early in the litigation, may be based on an agreement allowing the enterprise to use the licensing company’s portfolio against its competitors.</p>
Licensing Company vs. Start-Up Enterprise	<p>Such suits often are timed to critical events for the start-up. Very early settlement or settlement after the start-up accomplishes the event is likely. Obtaining participation from senior start-up company officers while the critical event is pending can be difficult and may justify telephone or other non-traditional participation in the mediation.</p>
Serial Litigant: Patent Owner vs. First Alleged Infringer	<p>Such patent owners face the collateral risk that an adverse <i>Markman</i> or other substantive ruling dooms not just this case, but the entire flotilla behind it. On the other hand, while a win cannot be used as collateral estoppel in subsequent suits, it can be persuasive in them, especially if they are brought in the same court. This may create settlement opportunities while important substantive rulings are pending.</p>
Branded Pharmaceutical vs. Branded Pharmaceutical	<p>Difficult, and often impossible, cases to settle, as industry economics are based on an exclusive position in marketing patent-protected drugs.</p>

Case Category	Settlement Issues
Branded Pharmaceutical vs. Generic	Often based on Hatch-Waxman Act provisions that grant the generic a 180-day period of exclusivity after it enters the market. 21 U.S.C. § 355(j)(5)(B)(iv). Regarding Hatch-Waxman litigation generally, see Chapter 10. Because delaying actual market entry by the generic delays entry by all generics and because the economic loss to the pharmaceutical company after entry usually far exceeds profit to the generic, some of these cases have been settled by “reverse payments,” payments by the pharmaceutical company to the generic to remain off the market for a period of time. Such settlements have been approved by appellate courts so long as the exclusion is no greater than the exclusionary potential of the pharmaceutical company’s patent, but continue to be challenged by the Federal Trade Commission as anticompetitive. See <i>Joblove v. Barr Labs, Inc.</i> , 429 F.3d 370 (2d Cir. 2005), <i>amended</i> , 466 F.3d 187 (2006), <i>cert. denied</i> , 127 S. Ct. 3001 (2007); <i>Schering-Plough Corp. v. FTC</i> , 402 F.3d 1056 (11th Cir. 2005), <i>cert. denied</i> , 126 S. Ct. 2929 (2006).
Medical Device Industry	Historically an industry with a large amount of patent litigation, so it is likely the litigants have a history of litigation against each other; they may have other related or unrelated litigation in other courts, and they may have patent portfolios that threaten future litigation. Early settlement of the litigation is unlikely. Otherwise, like other “Competitor vs. Competitor” litigation (above), settlement will depend on whether the technology is “core” to a significant product.
Preliminary Injunction Motion	Motions for preliminary injunction present an opportunity for very early consideration of settlement: counsel quickly become knowledgeable, parties focus early on strengths and weaknesses, and there is a period early in the case while a potentially important ruling is pending.

Appendix 2.1

Initial Case-Management Conference Summary Checklist

Ask for an informal description of the technology.

Ask for a brief statement/summary of claims and defenses by each party and related background issues, including an informal and general description of the following:

- Identity of the accused products
- Whether the primary basis for asserted liability is direct or indirect infringement
- Whether there are there any third parties from which the parties expect to obtain substantial discovery
- Scope of accused products relative to the defendant's business
- Scope of the patented/embodiment technology relative to the patentee's business
- Whether the parties are competitors
- Whether the patent(s)-in-suit have been, or are likely to be, the subject of reexamination proceedings
- Potential for parallel litigation and/or *inter partes* or covered business method review
 - Will a party seek a stay, consolidation, coordination, or transfer?
- Identify patent eligibility (§ 101) issues and discuss when they should be addressed
- What type of relief is being sought?
 - What damage theory(ies) will be pursued? How will they be proven?
 - What are the estimated damages?
 - Will injunctive relief be sought, and what kind?
 - What do the parties contend is the “smallest saleable patent practicing unit”?
 - Is the patentee licensing the technology and when will it produce licensing information?
 - Are any technology standards implicated?

Protective Order

- Is a protective order needed?
- Will a standard protective order suffice or will any party seek special requirements?
- Discuss known points of contention (e.g., prosecution bar, levels of confidentiality, access by in-house lawyers) and, if applicable, convey the court's general perspective on such issues

Discuss special issues related to willfulness (if asserted)

- Timing of the assertion of the claim
- Timing of the reliance on any opinion of counsel
- Possibility of bifurcation
- Possibility of disqualification of counsel

Discuss alternative dispute resolution (ADR)

- Usefulness
- Timing
- Mediation, arbitration, or other form

Discuss electronic discovery and consider limitations on discovery

- Format(s) for production of electronic discovery
- Limits on the scope of electronic discovery
- Source code – how will it be produced?
- Limits on the number of custodians
- Number of total hours for fact witnesses or number of depositions

Discuss contention disclosures and schedule therefor

- In patent local rule jurisdictions, discuss whether variance from the standard disclosure timelines is appropriate
- In jurisdictions without patent local rules, discuss whether the parties should exchange infringement, invalidity, unenforceability, and damages contentions and the appropriate schedule for such disclosures

Set timing and procedures for claim construction and dispositive motions

- Determine timing of summary judgment relative to claim construction
- If not addressed by local rule, set a schedule for exchanges of claim terms, proposed constructions, and supporting evidence
- Discuss whether a tutorial would be appropriate

How conducted: By counsel? By experts? Submissions (e.g., DVDs)?

- Discuss the number of patents and patent claims that would be tried and possible ways of winnowing
- Discuss limits on the number of claim terms submitted for construction
 - Require an explanation of the significance of the term (e.g., effect on infringement/validity)
 - Ask parties to rank the disputed claim terms based on their significance for resolving the case

Discuss claim construction hearing logistics

- Identify disputed subsidiary factual issues
- Discuss whether live witnesses should be called

- Encourage parties to use graphics, animations, and other visual displays to aid in understanding the technology and disputed claim terms
- Schedule a pre-claim-construction conference to finalize the logistics for the hearing (held after the parties' positions on claim construction have crystallized)

Discuss whether any summary judgment issues depend on claim construction or can otherwise be resolved with little or no discovery, including

- Is there a dispute about the structure/function of the accused products?
- Is there any claim term or claim construction issue that, once decided, will compel infringement or noninfringement?
- Are there territorial issues (e.g., location of allegedly infringing acts) that affect infringement?
- Are there any claims or defenses that are purely legal in nature?
 - If so, discuss whether a first-track and second-track schedule for summary judgment would be appropriate for the case (see Chapter 6)

Discuss whether any limits on the number of summary judgment motions (or number of pages of briefing) should be imposed or modified

Discuss limits on prior art references

Discuss issues related to *Daubert* and in limine motions

- Schedule *Daubert* motions well in advance of pretrial conference, for example concurrently with summary judgment
- Discuss scope of in limine motion practice and advise parties that the court will not consider dispositive motions disguised as in limine motions
- Damages
 - Discuss whether it would be appropriate to require damages contentions and/or an expedited damages discovery schedule, or to take other steps to facilitate the early resolution of challenges to damages-related theories or expert testimony.

Appendix 2.2a Case Management Checklist

Honorable Leonard P. Stark, District of Delaware Case Management Checklist

Case Name and Number _____

Counsel

Lead Counsel for _____
Delaware Counsel for _____

Lead Counsel for _____
Delaware Counsel for _____

Meet and Confer

Counsel have met and conferred and have made good-faith efforts to discuss, in person and/or by telephone, each of the topics listed in the Checklist below, and will be prepared to address these topics at the Case Management Conference (“CMC”).

Discovery

- What are the core technical documents?
- Does any party intend to request production of electronic mail? If so, why? How many custodians should be searched? What methods will be used to search for electronic documents (e.g., key word searches, predictive coding)?
- How can the Court best assist the parties to provide meaningful interrogatory responses to avoid discovery disputes over the adequacy of such responses?
- If source code is going to be produced, when, where, and how will it be made available?

Claim Construction

- What are the 1 or 2 most important claim terms requiring construction?
- Should the Court consider a “super-early” limited claim construction hearing on those most important terms?
- What is the maximum number of claim terms the parties will ask the Court to construe?
- How can the parties help the Court achieve its goal of ruling on claim construction disputes within 60 days of the claim construction hearing?

Narrowing the Case

- At what point(s) in the case will it be appropriate to limit/reduce the number of accused devices/functionalities, asserted patents, asserted claims, invalidity defenses (including obviousness combinations), and prior art references?
- Are there products that are not colorably different than the currently-accused products that Plaintiff expects or Defendant should expect will be added to the case?
- Should damages or any other portion of the case be bifurcated?

Related Cases

- What related cases are pending, in any Court, and what is their filing date and current status?
- Does Plaintiff plan to file additional related cases and, if so, on what schedule and how should that plan affect how this case will proceed?
- Has any patent-in-suit been litigated before and how soon is Plaintiff willing to produce the results of any such litigation, including settlement agreements?

Remedies

- What initial revenue/sales information does Plaintiff need to assess the value of the case and how soon is Defendant willing to produce such information?
- What type of relief is Plaintiff seeking: lost profits, reasonable royalties, injunction, and/or any other form of relief?
- What does Plaintiff contend is the “smallest saleable unit”?
- Has the patent been licensed or offered for any license and how soon is Plaintiff willing to produce licensing information?

Amendments

- What will be the deadline for proposed amendments to the pleadings, including adding allegations of indirect and/or willful infringement as well as inequitable conduct?
- What will be the deadline for adding or altering the accused devices/functionalities, asserted claims, and prior art?

Supplementation

- Will expert declarations/affidavits be permitted to be filed with case-dispositive and other motions, without other parties’ agreement or leave of the Court?
- What will be the deadline for supplementing infringement, invalidity, damages, and other contentions?

Protective Order

- Are there any reasons this case requires provisions that are not typical of the protective order generally entered in this Court's patent cases?

Motions to Dismiss/Transfer/Stay

- Have any of these motions been filed and/or does any party anticipate filing such a motion?
- Will the parties consent to magistrate judge jurisdiction at least for the limited purpose of resolving these motions?¹¹
- Should discovery and other exchanges of information (e.g., Default Standards ¶ 4 disclosures) be stayed during pendency of these motions?

Motions for Summary Judgment

- Are there any motions that are potentially fully case dispositive – or that would be dispositive of such a significant portion of the case that its resolution would greatly enhance the likelihood of a cost-effective pre-trial disposition – and that the parties agree the Court should hear early?
- If the Court is to hear any early summary judgment motion, which, if any, other parts of the case should be stayed?
- If the Court is to hear any early summary judgment motion, what is the moving party going to give up (e.g., the opportunity to file a motion on the same subject matter later in the case)?

Other Matters

- Are any postgrant review procedures underway or planned that might affect the manner in which this case should proceed?
- Would the Plaintiff be willing to stipulate to a maximum damages figure in exchange for restrictive discovery and an accelerated trial date?
- How soon can this case be ready for alternative dispute resolution?

Scheduling

- Address each matter listed in the Revised Patent Form Scheduling Order and submit, along with this Checklist, a joint proposed scheduling order, clearly identifying points of disagreement.

11. The identity of any party or parties declining to consent should not be disclosed to the Court at any point, only the fact that there is not unanimous consent.

Appendix 2.2b

Revised Procedures for Managing Patent Cases

Honorable Leonard P. Stark, District of Delaware
Revised Procedures for Managing Patent Cases
(June 18, 2014)

As a result of the invaluable discussions in which I participated as part of the District of Delaware's Patent Study Group, and as previewed in my presentation to our District's chapter of the Federal Bar Association last month, I describe below the Revised Procedures that I will follow in handling patent cases.

Applicability

Unless otherwise ordered, these Revised Procedures will govern all *non-ANDA* patent cases filed on or after July 1, 2014, that are assigned to me.

General Principles

Early investment of judicial resources, both from myself and Magistrate Judge Burke, will lead more often to identification of the "best" schedule for each case, promoting overall efficiency in the processing of cases on my docket.

Each patent case will initially be treated as its own case, even if it is related to a case or cases that have already been filed.

I have attempted to identify – and, as best as possible, reduce or eliminate – the areas that generally provide the highest likelihood for lengthy delays.

Referral Order

Within seven (7) days of a new patent case being assigned to me, my staff will docket the following Referral Order:

This case will be governed by Judge Stark's Revised Procedures for Managing Patent Cases (see www.ded.uscourts.gov). In accordance with the Revised Procedures,

IT IS HEREBY ORDERED that:

1. any and all matters relating to scheduling, including entry of a Scheduling Order, are referred to Magistrate Judge Burke;
2. any and all motions to dismiss, stay, and/or transfer venue, relating

to all or any part of the case, whenever such motions may be filed, are referred to Judge Burke for disposition or report and recommendation, to the full extent permitted by the Constitution, statute, and rule; and

3. within seven (7) days of the date of this Referral Order, the plaintiff(s) shall file the Procedures Order, which is found on Judge Stark's website (see www.ded.uscourts.gov).

Procedures Order

Within seven (7) days after the Court enters the Referral Order, the plaintiff(s) will be responsible for filing the following proposed Procedures Order, which the Court will then "so order" on the docket:

IT IS HEREBY ORDERED that, subject to any subsequent order of the Court, the following procedures shall govern proceedings in this matter:

1. "Discovery Matters" Procedures.
 - a. Any discovery motion filed without first complying with the following procedures will be denied without prejudice to renew pursuant to these procedures.
 - b. Should counsel find, after good faith efforts - including **verbal** communication among Delaware and Lead Counsel for all parties to the dispute - that they are unable to resolve a discovery matter or a dispute relating to a protective order, the parties involved in the discovery matter or protective order dispute shall submit a joint letter in substantially the following form:

Dear Judge Stark:

The parties in the above-referenced matter write to request the scheduling of a discovery teleconference.

The following attorneys, including at least one Delaware Counsel and at least one Lead Counsel per party, participated in a verbal meet-and-confer (in person and/or by telephone) on the following date(s): _____

Delaware Counsel: _____

Lead Counsel: _____

The disputes requiring judicial attention are listed below:
[provide here a non-argumentative list of disputes requiring judicial attention]

- c. On a date to be set by separate order, generally not less than forty-eight (48) hours prior to the conference, the party seeking relief shall file with the Court a letter, not to exceed three (3) pages, outlining the issues in dispute and its position on those issues. On a date to be set by separate order, but generally not less than twenty-four (24) hours prior to the conference, any party opposing the application for relief may file a letter, not to exceed three (3) pages, outlining that party's reasons for its opposition.
 - d. Each party shall submit two (2) courtesy copies of its discovery letter and any attachments.
 - e. Should the Court find further briefing necessary upon conclusion of the telephone conference, the Court will order it. Alternatively, the Court may choose to resolve the dispute prior to the telephone conference and will, in that event, cancel the conference.
2. Motions to Amend.
- a. Any motion to amend (including a motion for leave to amend) a pleading shall **NOT** be accompanied by an opening brief but shall, instead, be accompanied by a letter, not to exceed three (3) pages, describing the basis for the requested relief, and shall attach the proposed amended pleading as well as a "blackline" comparison to the prior pleading.
 - b. Within seven (7) days after the filing of a motion in compliance with this Order, any party opposing such a motion shall file a responsive letter, not to exceed five (5) pages.
 - c. Within three (3) days thereafter, the moving party may file a reply letter, not to exceed two (2) pages, and, by this same

date, the parties shall file a letter requesting a teleconference to address the motion to amend.

3. Motions to Strike.
 - a. Any motion to strike any pleading or other document shall **NOT** be accompanied by an opening brief but shall, instead, be accompanied by a letter, not to exceed three (3) pages, describing the basis for the requested relief, and shall attach the document to be stricken.
 - b. Within seven (7) days after the filing of a motion in compliance with this Order, any party opposing such a motion shall file a responsive letter, not to exceed five (5) pages.
 - c. Within three (3) days thereafter, the moving party may file a reply letter, not to exceed two (2) pages, and, by this same date, the parties shall file a letter requesting a teleconference to address the motion to strike.
4. Scheduling Order. The foregoing procedures shall be repeated in the scheduling order to be entered in this case.

Scheduling and Case Management

As noted in the Referral Order, scheduling will be managed by Judge Burke, who will have full authority to work with the parties to craft a schedule appropriate to the particular circumstances of each patent case. Judge Burke's decisions with respect to scheduling are subject to reversal only for abuse of discretion.

Within ten (10) days after any defendant has filed a responsive pleading (e.g., answer, counterclaim, cross-claim) or a motion in lieu of (or in addition to) a responsive pleading, my staff or Judge Burke's staff will docket the following Case Management Order:

At least one defendant in this matter having filed a responsive pleading or a motion in lieu of (or in addition to) a responsive pleading,

IT IS HEREBY ORDERED that:

The parties shall meet and confer and discuss, in person and/or by telephone, each of the matters listed on the Court's Case Management Checklist ("Checklist"). Within thirty (30) days of the date of this Order, the parties shall jointly file the Checklist and their proposed scheduling order (consistent with the Court's Revised

Patent Form Scheduling Order). Thereafter, the Court will schedule an in-person Case Management Conference/Rule 16 Scheduling Conference (“CMC”) to be held with Judge Stark and/or Judge Burke. The Checklist and Revised Patent Form Scheduling Order can be found on the Court’s website (www.ded.uscourts.gov).

A copy of the Checklist is available on the Court’s website (www.ded.uscourts.gov). I recognize that some of the questions on the Checklist may relate to case strategy. Nonetheless, I expect counsel to make good faith efforts to discuss, in person and/or by telephone, each of the topics listed.

A copy of the Revised Patent Form Scheduling Order is available on the Court’s website (www.ded.uscourts.gov).

The Case Management Conference (“CMC”), which also serves as the scheduling conference pursuant to Federal Rule of Civil Procedure 16, will be held in chambers or in the courtroom, on the record, with Judge Stark and/or Judge Burke. A court reporter will be present. At the CMC, each party must be represented by Lead Counsel and Delaware Counsel and be prepared to discuss each matter on the Checklist as well as any other matter that will be helpful or necessary to determining the most appropriate manner of managing the case. If there is a topic which a party thinks is inappropriate or premature to discuss, that party will have to explain its reasons for that view.

After the CMC, the Court may order the submission of a revised proposed scheduling order.

Where there are multiple related cases involving unrelated defendants, any party may request that the Court defer scheduling the CMC until a later date. Any party requesting such a deferral must accompany the request with a proposed order that, if entered, will require the parties to provide regular status reports advising the Court as to when they believe the case will be ready for a CMC and scheduling order. The greater the agreement among the parties to the related cases that deferral is appropriate, the more likely it is that deferral will be granted.

With rare exceptions, we will schedule trial upon entry of the scheduling order, setting a maximum number of trial days, double- and triple-tracking trials on my calendar as necessary.

If an early trial date is desired, the parties are reminded that if they unanimously consent to the jurisdiction of a Magistrate Judge, Judge Burke will almost always be able to proceed to trial more quickly than Judge Stark.

Where there are multiple related cases involving unrelated defendants, the Court will determine at some point (possibly as late as the pretrial conference) which defendant(s) will be tried first.

Motions to Dismiss, Transfer, or Stay

As noted in the Referral Order, any and all motions to dismiss, transfer, and/or stay will be referred to Judge Burke. Parties are reminded that they may consent to the jurisdiction of a Magistrate Judge for the limited purpose of final resolution of any motion, which has the effect of eliminating the right to file objections in the District Court, essentially giving the Magistrate Judge the same authority a District Judge would have with respect to that motion.

Generally, we will not defer the CMC and scheduling process solely due to the pendency of any of these motions.

Motions to Amend or Strike

As noted in the Procedures Order, any and all motions to amend (or motions for leave to amend) and/or strike will not be accompanied by full briefing but will, instead, be channeled into the “discovery matters” procedures.

Narrowing the Case

In order to manage my docket, and to ensure that litigation proceeds efficiently, I will be highly receptive to reasonable proposals to reduce, at an appropriate stage or stages of a case, the number of: patents-in-suit, asserted claims, accused products, invalidating references, combinations of invalidating references, invalidity defenses, and claim construction disputes.

Discovery

I have modified my discovery matters procedures in several ways, most notably as follows:

- there is no longer a requirement that counsel call chambers to request a discovery teleconference. Instead, counsel are required to submit a joint, non-argumentative letter, representing that Delaware Counsel and Lead Counsel have spoken about the issues in dispute, listing the issues on which counsel believe judicial intervention is required, and requesting the scheduling of a discovery dispute teleconference (a form for the letter is included with the Procedures Order)
- there is no longer a requirement that the parties submit copies of sealed documents within an hour after filing their letters
- parties are required to submit two (2) courtesy copies of their discovery letters and attachments

Discovery teleconferences will continue to be limited to approximately 30-45 minutes each.

Default Standards/Exchange of Contentions

Absent agreement among the parties or an order of the Court, the scheduling order will include dates for the exchange, in steps, of the following:

- Plaintiff shall identify the accused product(s), including accused methods and systems, and its damages model, as well as the asserted patent(s) that the accused product(s) allegedly infringe(s). Plaintiff shall also produce the file history for each asserted patent.
- Defendant shall produce core technical documents related to the accused product(s), sufficient to show how the accused product(s) work(s), including but not limited to non-publicly available operation manuals, product literature, schematics, and specifications. Defendant shall also produce sales figures for the accused product(s).
- Plaintiff shall produce an initial claim chart relating each known accused product to the asserted claims each such product allegedly infringes.
- Defendant shall produce its initial invalidity contentions for each asserted claim, as well as the known related invalidating references.
- Plaintiff shall provide final infringement contentions.
- Defendant shall provide final invalidity contentions.

Also absent agreement among the parties or an order of the Court, the scheduling order will include a date by which all parties must finally supplement, inter alia, the identification of all accused products and of all invalidity references.

The foregoing are the same procedures contained in Judge Robinson's recently issued "Patent Case Scheduling Order" ("SLR Order") (see ¶ 1.c, 1.f, 1.g).

Markman

I have set an aspirational goal of issuing all *Markman* rulings within 60 days after a *Markman* hearing. If I determine (due to, for example, an outsized number of claim disputes, deficiencies with the briefing, or scheduling congestion) that I will be unable to meet my goal, I will advise counsel of this fact.

Although I will continue to prefer having only a single *Markman* hearing in each case, and even just a single *Markman* hearing across all of any number of related cases, I do not plan to adhere rigidly to this preference. The parties should be prepared to discuss at the CMC whether a case or cases would be more efficiently handled by construing certain terms at an earlier point than other terms.

While I am not adopting Judge Robinson's requirement that "[f]or any contested claim limitation, each party must submit a proposed construction; i.e., 'plain and ordinary' meaning generally is not helpful to either the court or a jury" (SLR Order ¶ 5.b), I agree with her reasoning and am usually not persuaded that "plain and ordinary meaning" is an appropriate resolution of a material dispute over the scope of a claim term.

Summary Judgment/Daubert (Motions to Preclude/Exclude)

I will continue to permit parties to file as many summary judgment and *Daubert* (i.e., motions to exclude or preclude anticipated expert testimony, in whole or in part) motions as they wish, subject to the restriction that each side is limited to no more than a total of fifty (50) pages of combined opening briefs in support of any and all such motions, no more than fifty (50) pages of combined answering briefs in opposition to the motions, and no more than twenty (20) pages of combined reply briefs in support of their motions.

The parties must work together to ensure that the Court receives no more than a **total of 250 pages** (i.e., 50 + 50 + 25 regarding one side's motions, and 50 + 50 + 25 regarding the other side's motions) of briefing on all case dispositive motions and *Daubert* motions that are covered by this scheduling order and any other scheduling order entered in any related case that is proceeding on a consolidated or coordinated pretrial schedule.

I will generally include in the scheduling order a date for argument on any motions for summary judgment and *Daubert* motions. Such a hearing will typically be held approximately two months prior to the pretrial conference. Generally, counsel should expect they will be given a total of no more than forty-five (45) minutes per side to present their arguments on all pending motions.

Pretrial Order

I have revised my form pretrial order. (See "Proposed Final Pretrial Order- Patent" at www.ded.uscourts.gov.) I note some of the more important changes below.

I have clarified that when parties estimate the anticipated length of trial, they must do so not only in terms of trial days but also in terms of a specific request for a number of hours they need for their trial presentations. In formulating such a request, counsel should assume that they will be charged time for: opening statements, examination of witnesses (including by playing or reading deposition testimony), closing arguments, arguing objections (including in the mornings before trial begins), and arguing motions (including for judgment as a matter of law). I usually do not charge time for jury selection, opening and final jury instructions, and arguments regarding jury instructions. Counsel should also assume that in a typical trial

day we can usually get in 5 1/2 – 6 1/2 hours in a jury trial and 6 – 7 hours in a bench trial.

Counsel need to indicate whether, in connection with efforts to impeach a witness with prior testimony, they wish to permit objections for incompleteness and/or lack of inconsistency.

Counsel need to indicate whether, in connection with objections to expert testimony as being beyond the scope of previous expert disclosures, they request that the Court rule on such objections at trial or defer ruling unless and until the objections are renewed in connection with post-trial motions (with costs of the new trial to be charged entirely to the party whose trial conduct necessitates a new trial).

With respect to motions for judgment as a matter of law pursuant to Fed. R. Civ. P. 50, counsel need to indicate whether they request such motions: (i) be made at sidebar while the jury remains in the courtroom, (ii) be made immediately at the appropriate point during trial, and (iii) be supplemented in writing (and, if so, when).

Pretrial Conference

I expect to continue to conduct pretrial conferences largely as I have done to this point, although I will generally limit them to two (2) hours or less.

Jury Instructions, Voir Dire, Verdict Sheet

Where a case is to be tried to a jury, the parties must provide the Court with courtesy copies of the required documents – proposed voir dire, preliminary jury instructions, final jury instructions, and special verdict forms – as computer files. These courtesy copies may be sent by e-mail to my staff. The files may be in either WordPerfect or Microsoft Word format.

Trial

I expect to continue to conduct trials largely as I have done to this point.

After the jury returns a verdict, I will generally order the preparation of a joint status report, in which the parties should indicate, after meeting and conferring, how they believe the case should proceed, including whether (and when) additional briefing and/or in-court proceedings will be required.

The joint status report should identify the post-trial motions and issues on which any party intends to seek relief.

The joint status report should be accompanied by a proposed order to enter judgment on the verdict.

Post-Trial Motions

Unless otherwise ordered, briefing is according to Local Rules, no matter how many motions are filed by a party. That is, each side may file a maximum total of twenty (20) pages of opening briefing, twenty (20) pages of answering briefing, and ten (10) pages of reply briefing, ***regardless of how many motions are filed.***

Where possible, I will try to advise the parties as to my inclinations with respect to the issues that they plan to raise in their post-trial motions, so the parties may better assess whether I am likely to disturb the verdict of the jury.

Appendix 2.2c

Revised Patent Form Scheduling Order

Honorable Leonard P. Stark, District of Delaware

Revised Patent Form Scheduling Order

Revised June 2014

[NOTE: text in brackets is for guidance and should be deleted from proposed schedules submitted for the Court's consideration]

This ____ day of ____, 201__, the Court having conducted a Case Management Conference/Rule 16 scheduling and planning conference pursuant to Local Rule 16.2(a) and Judge Stark's Revised Procedures for Managing Patent Cases (which is posted at <http://www.ded.uscourts.gov>; see Chambers, Judge Leonard P. Stark, Patent Cases) on _____, 201__, and the parties having determined after discussion that the matter cannot be resolved at this juncture by settlement, voluntary mediation, or binding arbitration;

IT IS HEREBY ORDERED that:

1. Rule 26(a)(1) Initial Disclosures and e-Discovery Default Standard. Unless otherwise agreed to by the parties, the parties shall make their initial disclosures pursuant to Federal Rule of Civil Procedure 26(a)(1) within five (5) days of the date of this Order. If they have not already done so, the parties are to review the Court's Default Standard for Discovery, Including Discovery of Electronically Stored Information ("ESI") (which is posted at <http://www.ded.uscourts.gov>; see Other Resources, Default Standards for Discovery, and is incorporated herein by reference).

2. Joinder of Other Parties and Amendment of Pleadings. All motions to join other parties, and to amend or supplement the pleadings, shall be filed on or before _____, 201__.

3. Application to Court for Protective Order. Should counsel find it will be necessary to apply to the Court for a protective order specifying terms and conditions for the disclosure of confidential information, counsel should confer and attempt to reach an agreement on a proposed form of order and submit it to the Court within ten (10) days from the date of this Order. Should counsel be unable to reach an agreement on a proposed form of order, counsel must follow the provisions of Paragraph 8(g) below.

Any proposed protective order must include the following paragraph:

Other Proceedings. By entering this order and limiting the disclosure of information in this case, the Court does not intend to preclude another court from finding that information may be relevant and subject to disclosure in another case. Any person or party subject to this order who becomes subject to a motion to disclose

another party's information designated "confidential" [the parties should list any other level of designation, such as "highly confidential," which may be provided for in the protective order] pursuant to this order shall promptly notify that party of the motion so that the party may have an opportunity to appear and be heard on whether that information should be disclosed.

4. Papers Filed Under Seal. In accordance with section G of the Administrative Procedures Governing Filing and Service by Electronic Means, a redacted version of any sealed document shall be filed electronically within seven (7) days of the filing of the sealed document. Should any party intend to request to seal or redact all or any portion of a transcript of a court proceeding (including a teleconference), such party should expressly note that intent at the start of the court proceeding. Should the party subsequently choose to make a request for sealing or redaction, it must, promptly after the completion of the transcript, file with the Court a motion for sealing/redaction, and include as attachments (1) a copy of the complete transcript highlighted so the Court can easily identify and read the text proposed to be sealed/redacted, and (2) a copy of the proposed redacted/sealed transcript. With their request, the party seeking redactions must demonstrate why there is good cause for the redactions and why disclosure of the redacted material would work a clearly defined and serious injury to the party seeking redaction.

5. Courtesy Copies. Other than with respect to "discovery matters," which are governed by paragraph 8(g), and the final pretrial order, which is governed by paragraph 20, the parties shall provide to the Court two (2) courtesy copies of all briefs and one (1) courtesy copy of any other document filed in support of any briefs (i.e., appendices, exhibits, declarations, affidavits etc.). This provision also applies to papers filed under seal.

6. ADR Process. This matter is referred to a magistrate judge to explore the possibility of alternative dispute resolution.

7. Disclosures. Absent agreement among the parties, and approval of the Court:

a. By _____, Plaintiff shall identify the accused product(s), including accused methods and systems, and its damages model, as well as the asserted patent(s) that the accused product(s) allegedly infringe(s). Plaintiff shall also produce the file history for each asserted patent.

b. By _____, Defendant shall produce core technical documents related to the accused product(s), sufficient to show how the accused product(s) work(s), including but not limited to non-publicly available operation manuals, product literature, schematics, and specifications. Defendant shall also produce sales figures for the accused product(s).

c. By _____, Plaintiff shall produce an initial claim chart relating each known accused product to the asserted claims each such product allegedly infringes.

d. By _____, Defendant shall produce its initial invalidity contentions for each asserted claim, as well as the known related invalidating references.

e. By _____, Plaintiff shall provide final infringement contentions.

f. By _____, Defendant shall provide final invalidity contentions.

8. Discovery. Unless otherwise ordered by the Court, the limitations on discovery set forth in Local Rule 26.1 shall be strictly observed.

a. Discovery Cut Off. All discovery in this case shall be initiated so that it will be completed on or before _____, 201__.

b. Document Production. Document production shall be substantially complete by _____, 201__.

c. Requests for Admission. A maximum of _ requests for admission are permitted for each side.

d. Interrogatories.

i. A maximum of ____ interrogatories, including contention interrogatories, are permitted for each side.

ii. The Court encourages the parties to serve and respond to contention interrogatories early in the case. In the absence of agreement among the parties, contention interrogatories, if filed, shall first be addressed by the party with the burden of proof. The adequacy of all interrogatory answers shall be judged by the level of detail each party provides; i.e., the more detail a party provides, the more detail a party shall receive.

e. Depositions.

i. Limitation on Hours for Deposition Discovery. Each side is limited to a total of _ hours of taking testimony by deposition upon oral examination.

ii. Location of Depositions. Any party or representative (officer, director, or managing agent) of a party filing a civil action in this district court must ordinarily be required, upon request, to submit to a deposition at a place designated within this district.

Exceptions to this general rule may be made by order of the Court. A defendant who becomes a counterclaimant, cross-claimant, or third-party plaintiff shall be considered as having filed an action in this Court for the purpose of this provision.

f. Disclosure of Expert Testimony.

i. Expert Reports. For the party who has the initial burden of proof on the subject matter, the initial Federal Rule 26(a)(2) disclosure of expert testimony is due on or before _____, 201__. The supplemental disclosure to contradict or rebut evidence on the same matter identified by another party is due on or before _____, 201__. Reply expert reports from the party with the initial burden of proof are due on or before _____. No other expert reports will be permitted without either the consent of all parties or leave of the Court.

Along with the submissions of the expert reports, the parties shall advise of the dates and times of their experts' availability for deposition.

ii. Expert Report Supplementation. The parties agree they [will] [will not] [CHOOSE ONE] permit expert declarations to be filed in connection with motions briefing (including case-dispositive motions).

iii. Objections to Expert Testimony. To the extent any objection to expert testimony is made pursuant to the principles announced in *Daubert v. Merrell Dow Pharm., Inc.*, 509 U.S. 579 (1993), as incorporated in Federal Rule of Evidence 702, it shall be made by motion no later than the deadline for dispositive motions set forth herein, unless otherwise ordered by the Court. Briefing on such motions is subject to the page limits set out in connection with briefing of case dispositive motions.

g. Discovery Matters and Disputes Relating to Protective Orders.

i. Any discovery motion filed without first complying with the following procedures will be denied without prejudice to renew pursuant to these procedures.

ii. Should counsel find, after good faith efforts - including *verbal* communication among Delaware and Lead Counsel for all parties to the dispute - that they are unable to resolve a discovery matter or a dispute relating to a protective order, the parties involved in the discovery matter or protective order dispute shall submit a joint letter in substantially the following form:

Dear Judge Stark:

The parties in the above-referenced matter write to request the scheduling of a discovery teleconference.

The following attorneys, including at least one Delaware Counsel and at least one Lead Counsel per party, participated in a verbal meet-and-confer (in person and/or by telephone) on the following date(s):

Delaware Counsel: _____

Lead Counsel: _____

The disputes requiring judicial attention are listed below: [provide here a non-argumentative list of disputes requiring judicial attention]

iii. On a date to be set by separate order, generally not less than forty-eight (48) hours prior to the conference, the party seeking relief shall file with the Court a letter, not to exceed three (3) pages, outlining the issues in dispute and its position on those issues. On a date to be set by separate or-

der, but generally not less than twenty-four (24) hours prior to the conference, any party opposing the application for relief may file a letter, not to exceed three (3) pages, outlining that party's reasons for its opposition.

iv. Each party shall submit two (2) courtesy copies of its discovery letter and any attachments.

v. Should the Court find further briefing necessary upon conclusion of the telephone conference, the Court will order it. Alternatively, the Court may choose to resolve the dispute prior to the telephone conference and will, in that event, cancel the conference.

9. Motions to Amend.

a. Any motion to amend (including a motion for leave to amend) a pleading shall NOT be accompanied by an opening brief but shall, instead, be accompanied by a letter, not to exceed three (3) pages, describing the basis for the requested relief, and shall attach the proposed amended pleading as well as a "blackline" comparison to the prior pleading.

b. Within seven (7) days after the filing of a motion in compliance with this Order, any party opposing such a motion shall file a responsive letter, not to exceed five (5) pages.

c. Within three (3) days thereafter, the moving party may file a reply letter, not to exceed two (2) pages, and, by this same date, the parties shall file a letter requesting a teleconference to address the motion to amend.

10. Motions to Strike.

a. Any motion to strike any pleading or other document shall NOT be accompanied by an opening brief but shall, instead, be accompanied by a letter, not to exceed three (3) pages, describing the basis for the requested relief, and shall attach the document to be stricken.

b. Within seven (7) days after the filing of a motion in compliance with this Order, any party opposing such a motion shall file a responsive letter, not to exceed five (5) pages.

c. Within three (3) days thereafter, the moving party may file a reply letter, not to exceed two (2) pages, and, by this same date, the parties shall file a letter requesting a teleconference to address the motion to strike.

11. Tutorial Describing the Technology and Matters in Issue. Unless otherwise ordered by the Court, the parties shall provide the Court, no later than the date on which their opening claim construction briefs are due, a tutorial on the technology at issue. In that regard, the parties may separately or jointly submit a DVD of not more than thirty (30) minutes. The tutorial should focus on the technology in issue and should not be used for argument. The parties may choose to file their tutorial(s) under seal, subject to any protective order in effect. Each party may comment, in writing (in no more than five (5) pages) on the opposing party's tutorial. Any such

comment shall be filed no later than the date on which the answering claim construction briefs are due. As to the format selected, the parties should confirm the Court's technical abilities to access the information contained in the tutorial (currently best are "mpeg" or "quicktime").

12. Claim Construction Issue Identification. On _____, 201__, the parties shall exchange a list of those claim term(s)/phrase(s) that they believe need construction and their proposed claim construction of those term(s)/phrase(s). This document will not be filed with the Court. Subsequent to exchanging that list, the parties will meet and confer to prepare a Joint Claim Construction Chart to be submitted on _____, 201__. The parties' Joint Claim Construction Chart should identify for the Court the term(s)/ phrase(s) of the claim(s) in issue, and should include each party's proposed construction of the disputed claim language with citation(s) only to the intrinsic evidence in support of their respective proposed constructions. A copy of the patent(s) in issue as well as those portions of the intrinsic record relied upon shall be submitted with this Joint Claim Construction Chart. In this joint submission, the parties shall not provide argument.

13. Claim Construction Briefing. The parties shall contemporaneously submit initial briefs on claim construction issues on _____, 201__. The parties' answering/responsive briefs shall be contemporaneously submitted on _____, 201__. No reply briefs or supplemental papers on claim construction shall be submitted without leave of the Court. Local Rule 7.1.3(4) shall control the page limitations for initial (opening) and responsive (answering) briefs.

14. Hearing on Claim Construction. Beginning at ____ .m. on _____, 201__, the Court will hear argument on claim construction. The parties shall notify the Court, by joint letter submission, no later than the date on which their answering claim construction briefs are due: (i) whether they request leave to present testimony at the hearing; and (ii) the amount of time they are requesting be allocated to them for the hearing.

Provided that the parties comply with all portions of this Scheduling Order, and any other orders of the Court, the parties should anticipate that the Court will issue its claim construction order within sixty (60) days of the conclusion of the claim construction hearing. If the Court is unable to meet this goal, it will advise the parties no later than sixty (60) days after the conclusion of the claim construction hearing.

15. Interim Status Report. On _____, 201__, counsel shall submit a joint letter to the Court with an interim report on the nature of the matters in issue and the progress of discovery to date. Thereafter, if the Court deems it necessary, it will schedule a status conference.

16. Supplementation. Absent agreement among the parties, and approval of the Court, no later than _____ the parties must finally supplement, inter alia, the identification of all accused products and of all invalidity references.

17. Case Dispositive Motions. All case dispositive motions, an opening brief, and affidavits, if any, in support of the motion shall be served and filed on or before _____, 201___. Briefing will be presented pursuant to the Court's Local Rules, as modified by this Order.

a. No early motions without leave. No case dispositive motion under Rule 56 may be filed more than ten (10) days before the above date without leave of the Court.

b. Page limits combined with Daubert motion page limits. Each party is permitted to file as many case dispositive motions as desired; provided, however, that each SIDE will be limited to a combined total of 40 pages for all opening briefs, a combined total of 40 pages for all answering briefs, and a combined total of 20 pages for all reply briefs regardless of the number of case dispositive motions that are filed. In the event that a party files, in addition to a case dispositive motion, a *Daubert* motion to exclude or preclude all or any portion of an expert's testimony, the total amount of pages permitted for all case dispositive and *Daubert* motions shall be increased to 50 pages for all opening briefs, 50 pages for all answering briefs, and 25 pages for all reply briefs for each *SIDE*.¹²

c. Hearing. The Court will hear argument on all pending case dispositive and *Daubert* motions on _____ beginning at _____. [The parties should propose a date approximately two months prior to the requested pretrial conference date.] Subject to further order of the Court, each side will be allocated a total of forty-five (45) minutes to present its argument on all pending motions.

18. Applications by Motion. Except as otherwise specified herein, any application to the Court shall be by written motion filed with the Clerk. Any non-dispositive motion should contain the statement required by Local Rule 7.1.1.

19. Pretrial Conference. On _____, 201__, the Court will hold a pretrial conference in Court with counsel beginning at ____ .m. [The parties should request a date approximately 2-4 weeks prior to their requested trial date.] Unless otherwise ordered by the Court, the parties should assume that filing the pretrial order satisfies the pretrial disclosure requirement of Federal Rule of Civil Procedure 26(a)(3). The parties shall file with the Court the joint proposed final pretrial order with the in-

12. The parties must work together to ensure that the Court receives no more than a total of 250 pages (i.e., 50 + 50 + 25 regarding one side's motions, and 50 + 50 + 25 regarding the other side's motions) of briefing on all case dispositive motions and *Daubert* motions that are covered by this scheduling order and any other scheduling order entered in any related case that is proceeding on a consolidated or coordinated pretrial schedule.

formation required by the form of Revised Final Pretrial Order- Patent, which can be found on the Court's website (www.ded.uscourts.gov), on or before _____, 201___. [The parties should insert a date no less than seven (7) days before the requested pretrial conference date.] Unless otherwise ordered by the Court, the parties shall comply with the timeframes set forth in Local Rule 16.3(d)(1)–(3) for the preparation of the joint proposed final pretrial order.

The parties shall provide the Court two (2) courtesy copies of the joint proposed final pretrial order and all attachments.

As noted in the Revised Final Pretrial Order- Patent, the parties shall include in their joint proposed final pretrial order, among other things:

a. a request for a specific number of *hours* for their trial presentations, as well as a requested number of days, based on the assumption that in a typical jury trial day (in which there is not jury selection, jury instruction, or deliberations), there will be 5 1/2 to 6 1/2 hours of trial time, and in a typical bench trial day there will be 6 to 7 hours of trial time;

b. their position as to whether the Court should allow objections to efforts to impeach a witness with prior testimony, including objections based on lack of completeness and/or lack of inconsistency;

c. their position as to whether the Court should rule at trial on objections to expert testimony as beyond the scope of prior expert disclosures, taking time from the parties' trial presentation to argue and decide such objections, or defer ruling on all such objections unless renewed in writing following trial, subject to the proviso that a party prevailing on such a post-trial objection will be entitled to have all of its costs associated with a new trial paid for by the party that elicited the improper expert testimony at the earlier trial; and

d. their position as to how to make motions for judgment as a matter of law, whether it be immediately at the appropriate point during trial or at a subsequent break, whether the jury should be in or out of the courtroom, and whether such motions may be supplemented in writing.

20. Motions *in Limine*. Motions *in limine* shall not be separately filed. All *in limine* requests and responses thereto shall be set forth in the proposed pretrial order. Each **SIDE** shall be limited to three (3) *in limine* requests, unless otherwise permitted by the Court. The *in limine* request and any response shall contain the authorities relied upon; each *in limine* request may be supported by a maximum of three (3) pages of argument and may be opposed by a maximum of three (3) pages of argument, and the side making the *in limine* request may add a maximum of one (1) additional page in reply in support of its request. If more than one party is supporting or opposing an *in limine* request, such support or opposition shall be combined in a single three (3) page submission (and, if the moving party, a single one (1) page

reply), unless otherwise ordered by the Court. No separate briefing shall be submitted on *in limine* requests, unless otherwise permitted by the Court.

21. Jury Instructions, Voir Dire, and Special Verdict Forms. Where a case is to be tried to a jury, pursuant to Local Rules 47 and 51 the parties should file (i) proposed voir dire, (ii) preliminary jury instructions, (iii) final jury instructions, and (iv) special verdict forms three (3) business days before the final pretrial conference. This submission shall be accompanied by a courtesy copy containing electronic files of these documents, in WordPerfect or Microsoft Word format, which may be submitted by e-mail to Judge Stark's staff.

22. Trial. This matter is scheduled for a ___ day trial beginning at 9:30 a.m. on _____, 201__, with the subsequent trial days beginning at 9:00 a.m. Until the case is submitted to the jury for deliberations, the jury will be excused each day at 4:30 p.m. The trial will be timed, as counsel will be allocated a total number of hours in which to present their respective cases.

23. Judgment on Verdict and Post-Trial Status Report. Within seven (7) days after a jury returns a verdict in any portion of a jury trial, the parties shall jointly submit a form of order to enter judgment on the verdict. At the same time, the parties shall submit a joint status report, indicating among other things how the case should proceed and listing any post-trial motions each party intends to file.

24. Post-Trial Motions. Unless otherwise ordered by the Court, all SIDES are limited to a maximum of 20 pages of opening briefs, 20 pages of answering briefs, and 10 pages of reply briefs relating to any post-trial motions filed by that side, no matter how many such motions are filed.

UNITED STATES DISTRICT JUDGE

Appendix 2.3 Patent Pilot Program

District	Participating Judges
Central District of California	<ul style="list-style-type: none"> • District Judge Andrew J. Guilford • District Judge S. James Otero • District Judge Otis D. Wright II • District Judge George H. Wu • District Judge James V. Selna • District Judge John A. Kronstadt
Northern District of California	<ul style="list-style-type: none"> • District Judge James Donato • District Judge Lucy H. Koh • District Judge Jeffrey S. White • Senior District Judge Ronald M. Whyte • Magistrate Judge Laurel Beeler • Magistrate Judge Jacqueline Scott Corley • Magistrate Judge Nathanael M. Cousins • Magistrate Judge Elizabeth M. Laporte • Magistrate Judge Paul S. Grewal • Magistrate Judge Joseph C. Spero • Magistrate Judge Donna M. Ryu
Southern District of California	<ul style="list-style-type: none"> • District Judge Roger T. Benitez • District Judge Marilyn L. Huff • District Judge Dana M. Sabraw • District Judge Janis L. Sammartino • District Judge Cathy Ann Bencivengo
Northern District of Illinois	<ul style="list-style-type: none"> • Chief Judge James F. Holderman • District Judge Ruben Castillo • District Judge John W. Darrah • District Judge Gary S. Feinerman • District Judge Virginia Kendall • District Judge Matthew F. Kennelly • District Judge Joan Humphrey Lefkow • District Judge Rebecca R. Pallmeyer • District Judge Amy J. St. Eve • District Judge James B. Zagel
District of Maryland	<ul style="list-style-type: none"> • District Judge Marvin J. Garbis • District Judge William D. Quarles, Jr. • District Judge Roger W. Titus

District	Participating Judges
District of Nevada	<ul style="list-style-type: none"> • Chief Judge Robert C. Jones • District Judge Gloria M. Navarro • District Judge Philip M. Pro • District Judge Miranda Mai Du
District of New Jersey	<ul style="list-style-type: none"> • Chief Judge Jerome B. Simandle • District Judge Renee M. Bumb • District Judge Claire C. Cecchi • District Judge Noel L. Hillman • District Judge Peter G. Sheridan • District Judge Susan D. Wigenton • Senior District Judge Stanley R. Chesler • Senior District Judge Mary L. Cooper • Senior District Judge Joseph E. Irenas
Eastern District of New York	<ul style="list-style-type: none"> • District Judge Brian M. Cogan • District Judge John Gleeson • District Judge Kiyo A. Matsumoto • District Judge William F. Kuntz II • District Judge Joanna Seybert • Senior District Judge Jack B. Weinstein • Chief Magistrate Judge Steven M. Gold • Magistrate Judge Joan A. Azrack • Magistrate Judge Marilyn D. Go • Magistrate Judge Gary Brown • Magistrate Judge Cheryl L. Pollak • Magistrate Judge James Orenstein • Magistrate Judge Ramon E. Reyes, Jr. • Magistrate Judge A. Kathleen Tomlinson • Magistrate Judge William D. Wall
Southern District of New York	<ul style="list-style-type: none"> • District Judge P. Kevin Castel • District Judge Denise Cote • District Judge Katherine B. Forrest • District Judge John G. Koeltl • District Judge Colleen McMahon • District Judge Laura Taylor Swain • Senior District Judge Thomas P. Griesa • Senior District Judge Jed S. Rakoff • Senior District Judge Shira A. Scheindlin • Senior District Judge Robert W. Sweet

Chapter 2: Early Case Management

District	Participating Judges
Western District of Pennsylvania	<ul style="list-style-type: none">• Chief Judge Gary L. Lancaster• District Judge Joy Flowers Conti• District Judge Nora Barry Fischer• District Judge Arthur J. Schwab• District Judge Cathy Bissoon• District Judge Mark R. Hornak
Western District of Tennessee	<ul style="list-style-type: none">• Chief Judge Jon P. McCalla• District Judge S. Hardy Mays, Jr.
Eastern District of Texas	<ul style="list-style-type: none">• Chief Judge Leonard E. Davis• District Judge Ron Clark• District Judge Rodney Gilstrap• District Judge Richard A. Schell• District Judge Michael H. Schneider, Sr.
Northern District of Texas	<ul style="list-style-type: none">• District Judge David C. Godbey• District Judge Ed Kinkeade• District Judge Barbara M.G. Lynn

Appendix 2.4 Protective Orders

Many district courts have established default protective orders in conjunction with or in addition to Patent Local Rules (PLRs). This appendix catalogs the districts with default protective orders and contains several representative examples. The highlighted documents are contained herein.

California

Northern District (updated Aug. 20, 2014), two forms reprinted here:

Appendix 2.4a: (1) Patent Local Rule 2-2 Interim Model Protective Order

Appendix 2.4b: (2) Model Protective Order for Litigation Involving Patents, Highly Sensitive Confidential Information and/or Trade Secrets

Note that a Stipulated Protective Order for Standard Litigation is also available at <http://www.cand.uscourts.gov/model-protective-orders>

Southern District (updated Feb. 2, 2015) (Patent Local Rules)

Delaware

Appendix 2.4e: Default Standard for Access to Source Code, updated Dec. 8, 2011

Illinois

Northern District

Appendix 2.4c: Model Protective Order (Appendix B)

Minnesota

Appendix 2.4d: Form 5. Stipulation for Protective Order

Missouri

Eastern District (Appendix A)

New Jersey

General Discovery Confidentiality Order; Appendix S to Local Patent Rules

New York

Northern District (available at www.nynd.uscourts.gov)

Ohio

Northern District (effective Oct. 22, 2009) (Appendix A)

Southern District (effective June 1, 2010) (Appendix A)

Pennsylvania

Western District (effective Dec. 1, 2005) (Appendix LPR 2.2)

Tennessee

Western District (Patent Case Protective Order, Appendix A)

Texas

Eastern District (effective Feb. 22, 2005) (sample form)

Northern District, Dallas Division (effective May 1, 2007) (Appendix A)

Southern District (effective Jan. 1, 2008)

Appendix 2.4a Northern District of California, Patent Local Rule 2-2 Interim Model Protective Order

UNITED STATES DISTRICT COURT
NORTHERN DISTRICT OF CALIFORNIA

Plaintiff,

v.

Defendant.

Case No. C
PATENT LOCAL RULE 2-2
INTERIM MODEL
PROTECTIVE ORDER

1. PURPOSES AND LIMITATIONS

Disclosure and discovery activity in this action are likely to involve production of confidential, proprietary, or private information for which special protection from public disclosure and from use for any purpose other than prosecuting this litigation may be warranted. This Order does not confer blanket protections on all disclosures or responses to discovery and the protection it affords from public disclosure and use extends only to the limited information or items that are entitled to confidential treatment under the applicable legal principles. As set forth in Section 14.4 below, this Protective Order does not entitle the Parties to file confidential information under seal; Civil Local Rule 79-5 sets forth the procedures that must be followed and the standards that will be applied when a party seeks permission from the court to file material under seal.

2. DEFINITIONS

2.1 Challenging Party: a Party or Non-Party that challenges the designation of information or items under this Order.

2.2 “CONFIDENTIAL” Information or Items: information (regardless of how it is generated, stored or maintained) or tangible things that qualify for protection under Federal Rule of Civil Procedure 26(c).

2.3 Counsel (without qualifier): Outside Counsel of Record and House Counsel (as well as their support staff).

2.4 Designated House Counsel: House Counsel who seek access to “HIGHLY CONFIDENTIAL – ATTORNEYS’ EYES ONLY” information in this matter.

2.5 Designating Party: a Party or Non-Party that designates information or items that it produces in disclosures or in responses to discovery as “CONFIDENTIAL,” “HIGHLY CONFIDENTIAL – ATTORNEYS’ EYES ONLY,” or “HIGHLY CONFIDENTIAL – SOURCE CODE.”

2.6 Disclosure or Discovery Material: all items or information, regardless of the medium or manner in which it is generated, stored, or maintained (including, among other things, testimony, transcripts, and tangible things), that are produced or generated in disclosures or responses to discovery in this matter.

2.7 Expert: a person with specialized knowledge or experience in a matter pertinent to the litigation who (1) has been retained by a Party or its counsel to serve as an expert witness or as a consultant in this action, (2) is not a past or current employee of a Party or of a Party’s competitor, and (3) at the time of retention, is not anticipated to become an employee of a Party or of a Party’s competitor.

2.8 “HIGHLY CONFIDENTIAL – ATTORNEYS’ EYES ONLY” Information or Items: extremely sensitive “Confidential Information or Items,” disclosure of which to another Party or Non-Party would create a substantial risk of serious harm that could not be avoided by less restrictive means.

2.9 “HIGHLY CONFIDENTIAL – SOURCE CODE” Information or Items: extremely sensitive “Confidential Information or Items” representing computer code and associated comments and revision histories, formulas, engineering specifications, or schematics that define or otherwise describe in detail the algorithms or structure of software or hardware designs, disclosure of which to another Party or Non-Party would create a substantial risk of serious harm that could not be avoided by less restrictive means.

2.10 House Counsel: attorneys who are employees of a party to this action. House Counsel does not include Outside Counsel of Record or any other outside counsel.

2.11 Non-Party: any natural person, partnership, corporation, association, or other legal entity not named as a Party to this action.

2.12 Outside Counsel of Record: attorneys who are not employees of a party to this action but are retained to represent or advise a party to this action and have appeared in this action on behalf of that party or are affiliated with a law firm which has appeared on behalf of that party.

2.13 Party: any party to this action, including all of its officers, directors, employees, consultants, retained experts, and Outside Counsel of Record (and their support staffs).

2.14 Producing Party: a Party or Non-Party that produces Disclosure or Discovery Material in this action.

2.15 Professional Vendors: persons or entities that provide litigation support services (e.g., photocopying, videotaping, translating, preparing exhibits or demonstrations, and organizing, storing, or retrieving data in any form or medium) and their employees and subcontractors.

2.16 Protected Material: any Disclosure or Discovery Material that is designated as “CONFIDENTIAL,” “HIGHLY CONFIDENTIAL – ATTORNEYS’ EYES ONLY,” or “HIGHLY CONFIDENTIAL – SOURCE CODE.”

2.17 Receiving Party: a Party that receives Disclosure or Discovery Material from a Producing Party.

3. SCOPE

The protections conferred by this Order cover not only Protected Material (as defined above), but also (1) any information copied or extracted from Protected Material; (2) all copies, excerpts, summaries, or compilations of Protected Material; and (3) any testimony, conversations, or presentations by Parties or their Counsel that might reveal Protected Material. However, the protections conferred by this Order do not cover the following information: (a) any information that is in the public domain at the time of disclosure to a Receiving Party or becomes part of the public domain after its disclosure to a Receiving Party as a result of publication not involving a violation of this Order, including becoming part of the public record through trial or otherwise; and (b) any information known to the Receiving Party prior to the disclosure or obtained by the Receiving Party after the disclosure from a source who obtained the information lawfully and under no obligation of confidentiality to the Designating Party. Any use of Protected Material at trial shall be governed by a separate agreement or order.

4. DURATION

Even after final disposition of this litigation, the confidentiality obligations imposed by this Order shall remain in effect until a Designating Party agrees otherwise in writing or a court order otherwise directs. Final disposition shall be deemed to be the later of (1) dismissal of all claims and defenses in this action, with or without prejudice; and (2) final judgment herein after the completion and exhaustion of all appeals, rehearings, remands, trials, or reviews of this action, including the time limits for filing any motions or applications for extension of time pursuant to applicable law.

5. DESIGNATING PROTECTED MATERIAL

5.1 Exercise of Restraint and Care in Designating Material for Protection. Each Party or Non-Party that designates information or items for protection under this Order must take care to limit any such designation to specific material that qualifies under the appropriate standards. To the extent it is practical to do so, the Designating Party must designate for protection only those parts of material, documents, items, or oral or written communications that qualify – so that other portions of the material, documents, items, or communications for which protection is not warranted are not swept unjustifiably within the ambit of this Order.

Mass, indiscriminate, or routinized designations are prohibited. Designations that are shown to be clearly unjustified or that have been made for an improper purpose (e.g., to unnecessarily encumber or retard the case development process or to impose unnecessary expenses and burdens on other parties) expose the Designating Party to sanctions.

If it comes to a Designating Party's attention that information or items that it designated for protection do not qualify for protection at all or do not qualify for the level of protection initially asserted, that Designating Party must promptly notify all other Parties that it is withdrawing the mistaken designation.

5.2 Manner and Timing of Designations. Except as otherwise provided in this Order (see, e.g., second paragraph of section 5.2(a) below), or as otherwise stipulated or ordered, Disclosure or Discovery Material that qualifies for protection under this Order must be clearly so designated before the material is disclosed or produced.

Designation in conformity with this Order requires:

(a) for information in documentary form (e.g., paper or electronic documents, but excluding transcripts of depositions or other pretrial or trial proceedings), that the Producing Party affix the legend "CONFIDENTIAL," "HIGHLY CONFIDENTIAL – ATTORNEYS' EYES ONLY," or "HIGHLY CONFIDENTIAL – SOURCE CODE" to each page that contains protected material. If only a portion or portions of the material on a page qualifies for protection, the Producing Party also must clearly identify the protected portion(s) (e.g., by making appropriate markings in the margins) and must specify, for each portion, the level of protection being asserted.

A Party or Non-Party that makes original documents or materials available for inspection need not designate them for protection until after the inspecting Party has indicated which material it would like copied and produced. During the inspection and before the designation, all of the material made available for inspection shall be deemed "HIGHLY CONFIDENTIAL – ATTORNEYS' EYES ONLY." After the

inspecting Party has identified the documents it wants copied and produced, the Producing Party must determine which documents, or portions thereof, qualify for protection under this Order. Then, before producing the specified documents, the Producing Party must affix the appropriate legend (“CONFIDENTIAL,” “HIGHLY CONFIDENTIAL – ATTORNEYS’ EYES ONLY,” or “HIGHLY CONFIDENTIAL – SOURCE CODE”) to each page that contains Protected Material. If only a portion or portions of the material on a page qualifies for protection, the Producing Party also must clearly identify the protected portion(s) (e.g., by making appropriate markings in the margins) and must specify, for each portion, the level of protection being asserted.

(b) for testimony given in deposition or in other pretrial or trial proceedings, that the Designating Party identify on the record, before the close of the deposition, hearing, or other proceeding, all protected testimony and specify the level of protection being asserted. When it is impractical to identify separately each portion of testimony that is entitled to protection and it appears that substantial portions of the testimony may qualify for protection, the Designating Party may invoke on the record (before the deposition, hearing, or other proceeding is concluded) a right to have up to 21 days to identify the specific portions of the testimony as to which protection is sought and to specify the level of protection being asserted. Only those portions of the testimony that are appropriately designated for protection within the 21 days shall be covered by the provisions of this Protective Order. Alternatively, a Designating Party may specify, at the deposition or up to 21 days afterwards if that period is properly invoked, that the entire transcript shall be treated as “CONFIDENTIAL” or “HIGHLY CONFIDENTIAL – ATTORNEYS’ EYES ONLY.”

Parties shall give the other parties notice if they reasonably expect a deposition, hearing, or other proceeding to include Protected Material so that the other parties can ensure that only authorized individuals who have signed the “Acknowledgment and Agreement to Be Bound” (Exhibit A) are present at those proceedings. The use of a document as an exhibit at a deposition shall not in any way affect its designation as “CONFIDENTIAL” or “HIGHLY CONFIDENTIAL – ATTORNEYS’ EYES ONLY.”

Transcripts containing Protected Material shall have an obvious legend on the title page that the transcript contains Protected Material, and the title page shall be followed by a list of all pages (including line numbers as appropriate) that have been designated as Protected Material and the level of protection being asserted by the Designating Party. The Designating Party shall inform the court reporter of these requirements. Any transcript that is prepared before the expiration of a 21-day period for designation shall be treated during that period as if it had been designated

“HIGHLY CONFIDENTIAL – ATTORNEYS’ EYES ONLY” in its entirety unless otherwise agreed. After the expiration of that period, the transcript shall be treated only as actually designated.

(c) for information produced in some form other than documentary and for any other tangible items, that the Producing Party affix in a prominent place on the exterior of the container or containers in which the information or item is stored the legend “CONFIDENTIAL,” “HIGHLY CONFIDENTIAL – ATTORNEYS’ EYES ONLY,” or “HIGHLY CONFIDENTIAL – SOURCE CODE.” If only a portion or portions of the information or item warrant protection, the Producing Party, to the extent practicable, shall identify the protected portion(s) and specify the level of protection being asserted.

5.3 Inadvertent Failures to Designate. If timely corrected, an inadvertent failure to designate qualified information or items does not, standing alone, waive the Designating Party’s right to secure protection under this Order for such material. Upon timely correction of a designation, the Receiving Party must make reasonable efforts to assure that the material is treated in accordance with the provisions of this Order.

6. CHALLENGING CONFIDENTIALITY DESIGNATIONS

6.1 Timing of Challenges. Any Party or Non-Party may challenge a designation of confidentiality at any time. Unless a prompt challenge to a Designating Party’s confidentiality designation is necessary to avoid foreseeable, substantial unfairness, unnecessary economic burdens, or a significant disruption or delay of the litigation, a Party does not waive its right to challenge a confidentiality designation by electing not to mount a challenge promptly after the original designation is disclosed.

6.2 Meet and Confer. The Challenging Party shall initiate the dispute resolution process by providing written notice of each designation it is challenging and describing the basis for each challenge. To avoid ambiguity as to whether a challenge has been made, the written notice must recite that the challenge to confidentiality is being made in accordance with this specific paragraph of the Protective Order. The parties shall attempt to resolve each challenge in good faith and must begin the process by conferring directly (in voice to voice dialogue; other forms of communication are not sufficient) within 14 days of the date of service of notice. In conferring, the Challenging Party must explain the basis for its belief that the confidentiality designation was not proper and must give the Designating Party an opportunity to review the designated material, to reconsider the circumstances, and, if no change in designation is offered, to explain the basis for the chosen designation. A Challenging Party may proceed to the next stage of the challenge process only if it has engaged in

this meet and confer process first or establishes that the Designating Party is unwilling to participate in the meet and confer process in a timely manner.

6.3 Judicial Intervention. If the Parties cannot resolve a challenge without court intervention, the Designating Party shall file and serve a motion to retain confidentiality under Civil Local Rule 7 (and in compliance with Civil Local Rule 79-5, if applicable) within 21 days of the initial notice of challenge or within 14 days of the parties agreeing that the meet and confer process will not resolve their dispute, whichever is earlier. Each such motion must be accompanied by a competent declaration affirming that the movant has complied with the meet and confer requirements imposed in the preceding paragraph. Failure by the Designating Party to make such a motion including the required declaration within 21 days (or 14 days, if applicable) shall automatically waive the confidentiality designation for each challenged designation. In addition, the Challenging Party may file a motion challenging a confidentiality designation at any time if there is good cause for doing so, including a challenge to the designation of a deposition transcript or any portions thereof. Any motion brought pursuant to this provision must be accompanied by a competent declaration affirming that the movant has complied with the meet and confer requirements imposed by the preceding paragraph.

The burden of persuasion in any such challenge proceeding shall be on the Designating Party. Frivolous challenges and those made for an improper purpose (e.g., to harass or impose unnecessary expenses and burdens on other parties) may expose the Challenging Party to sanctions. Unless the Designating Party has waived the confidentiality designation by failing to file a motion to retain confidentiality as described above, all parties shall continue to afford the material in question the level of protection to which it is entitled under the Producing Party's designation until the court rules on the challenge.

7. ACCESS TO AND USE OF PROTECTED MATERIAL

7.1 Basic Principles. A Receiving Party may use Protected Material that is disclosed or produced by another Party or by a Non-Party in connection with this case only for prosecuting, defending, or attempting to settle this litigation. Such Protected Material may be disclosed only to the categories of persons and under the conditions described in this Order. When the litigation has been terminated, a Receiving Party must comply with the provisions of section 15 below (FINAL DISPOSITION).

Protected Material must be stored and maintained by a Receiving Party at a location and in a secure manner that ensures that access is limited to the persons authorized under this Order.

7.2 Disclosure of “CONFIDENTIAL” Information or Items. Unless otherwise ordered by the court or permitted in writing by the Designating Party, a Receiving Party may disclose any information or item designated “CONFIDENTIAL” only to:

(a) the Receiving Party’s Outside Counsel of Record in this action, as well as employees of said Outside Counsel of Record to whom it is reasonably necessary to disclose the information for this litigation and who have signed the “Acknowledgment and Agreement to Be Bound” that is attached hereto as Exhibit A;

(b) the officers, directors, and employees (including House Counsel) of the Receiving Party to whom disclosure is reasonably necessary for this litigation and who have signed the “Acknowledgment and Agreement to Be Bound” (Exhibit A);

(c) Experts (as defined in this Order) of the Receiving Party to whom disclosure is reasonably necessary for this litigation and who have signed the “Acknowledgment and Agreement to Be Bound” (Exhibit A);

(d) the court and its personnel;

(e) court reporters and their staff, professional jury or trial consultants, and Professional Vendors to whom disclosure is reasonably necessary for this litigation and who have signed the “Acknowledgment and Agreement to Be Bound” (Exhibit A);

(f) during their depositions, witnesses in the action to whom disclosure is reasonably necessary and who have signed the “Acknowledgment and Agreement to Be Bound” (Exhibit A), unless otherwise agreed by the Designating Party or ordered by the court. Pages of transcribed deposition testimony or exhibits to depositions that reveal Protected Material must be separately bound by the court reporter and may not be disclosed to anyone except as permitted under this Protective Order.

(g) the author or recipient of a document containing the information or a custodian or other person who otherwise possessed or knew the information.

7.3 Disclosure of “HIGHLY CONFIDENTIAL – ATTORNEYS’ EYES ONLY” and “HIGHLY CONFIDENTIAL – SOURCE CODE” Information or Items. Unless otherwise ordered by the court or permitted in writing by the Designating Party, a Receiving Party may disclose any information or item designated “HIGHLY CONFIDENTIAL – ATTORNEYS’ EYES ONLY” or “HIGHLY CONFIDENTIAL – SOURCE CODE” only to:

(a) the Receiving Party’s Outside Counsel of Record in this action, as well as employees of said Outside Counsel of Record to whom it is reasonably necessary to disclose the information for this litigation and who have signed the “Acknowledgment and Agreement to Be Bound” that is attached hereto as Exhibit A;

(b) Designated House Counsel of the Receiving Party (1) who has no involvement in competitive decision-making, (2) to whom disclosure is reasonably necessary for this litigation, (3) who has signed the “Acknowledgment and Agreement to Be Bound” (Exhibit A), and (4) as to whom the procedures set forth in paragraph 7.4(a)(1), below, have been followed;¹³

(c) Experts of the Receiving Party (1) to whom disclosure is reasonably necessary for this litigation, (2) who have signed the “Acknowledgment and Agreement to Be Bound” (Exhibit A), and (3) as to whom the procedures set forth in paragraph 7.4(a)(2), below, have been followed;

(d) the court and its personnel;

(e) court reporters and their staff, professional jury or trial consultants, and Professional Vendors to whom disclosure is reasonably necessary for this litigation and who have signed the “Acknowledgment and Agreement to Be Bound” (Exhibit A); and

(f) the author or recipient of a document containing the information or a custodian or other person who otherwise possessed or knew the information.

7.4 Procedures for Approving or Objecting to Disclosure of “HIGHLY CONFIDENTIAL – ATTORNEYS’ EYES ONLY” or “HIGHLY CONFIDENTIAL – SOURCE CODE” Information or Items to Designated House Counsel or Experts.

(a)(1) Unless otherwise ordered by the court or agreed to in writing by the Designating Party, a Party that seeks to disclose to Designated House Counsel any information or item that has been designated “HIGHLY CONFIDENTIAL – ATTORNEYS’ EYES ONLY” pursuant to paragraph 7.3(b) first must make a written request to the Designating Party that (1) sets forth the full name of the Designated House Counsel and the city and state of his or her residence and (2) describes the Designated House Counsel’s current and reasonably foreseeable future primary job duties and responsibilities in sufficient detail to determine if House Counsel is involved, or may become involved, in any competitive decision-making.

(a)(2) Unless otherwise ordered by the court or agreed to in writing by the Designating Party, a Party that seeks to disclose to an Expert (as defined in this Order) any information or item that has been designated “HIGHLY CONFIDENTIAL – ATTORNEYS’ EYES ONLY” or “HIGHLY CONFIDENTIAL – SOURCE CODE” pursuant to paragraph 7.3(c) first must make a written request to the Designating

13. This Order contemplates that Designated House Counsel shall not have access to any information or items designated “HIGHLY CONFIDENTIAL – SOURCE CODE.”

Party that (1) identifies the general categories of “HIGHLY CONFIDENTIAL – ATTORNEYS’ EYES ONLY” or “HIGHLY CONFIDENTIAL – SOURCE CODE” information that the Receiving Party seeks permission to disclose to the Expert, (2) sets forth the full name of the Expert and the city and state of his or her primary residence, (3) attaches a copy of the Expert’s current resume, (4) identifies the Expert’s current employer(s), (5) identifies each person or entity from whom the Expert has received compensation or funding for work in his or her areas of expertise or to whom the expert has provided professional services, including in connection with a litigation, at any time during the preceding five years,¹⁴ and (6) identifies (by name and number of the case, filing date, and location of court) any litigation in connection with which the Expert has offered expert testimony, including through a declaration, report, or testimony at a deposition or trial, during the preceding five years.

(b) A Party that makes a request and provides the information specified in the preceding respective paragraphs may disclose the subject Protected Material to the identified Designated House Counsel or Expert unless, within 14 days of delivering the request, the Party receives a written objection from the Designating Party. Any such objection must set forth in detail the grounds on which it is based.

(c) A Party that receives a timely written objection must meet and confer with the Designating Party (through direct voice to voice dialogue) to try to resolve the matter by agreement within seven days of the written objection. If no agreement is reached, the Party seeking to make the disclosure to Designated House Counsel or the Expert may file a motion as provided in Civil Local Rule 7 (and in compliance with Civil Local Rule 79-5, if applicable) seeking permission from the court to do so. Any such motion must describe the circumstances with specificity, set forth in detail the reasons why disclosure to Designated House Counsel or the Expert is reasonably necessary, assess the risk of harm that the disclosure would entail, and suggest any additional means that could be used to reduce that risk. In addition, any such motion must be accompanied by a competent declaration describing the parties’ efforts to resolve the matter by agreement (i.e., the extent and the content of the meet and confer discussions) and setting forth the reasons advanced by the Designating Party for its refusal to approve the disclosure.

14. If the Expert believes any of this information is subject to a confidentiality obligation to a third-party, then the Expert should provide whatever information the Expert believes can be disclosed without violating any confidentiality agreements, and the Party seeking to disclose to the Expert shall be available to meet and confer with the Designating Party regarding any such engagement.

In any such proceeding, the Party opposing disclosure to Designated House Counsel or the Expert shall bear the burden of proving that the risk of harm that the disclosure would entail (under the safeguards proposed) outweighs the Receiving Party's need to disclose the Protected Material to its Designated House Counsel or Expert.

8. PROSECUTION BAR

Absent written consent from the Producing Party, any individual who receives access to "HIGHLY CONFIDENTIAL – ATTORNEYS' EYES ONLY" or "HIGHLY CONFIDENTIAL – SOURCE CODE" information shall not be involved in the prosecution of patents or patent applications relating to the subject matter of this action, including without limitation the patents asserted in this action and any patent or application claiming priority to or otherwise related to the patents asserted in this action, before any foreign or domestic agency, including the United States Patent and Trademark Office ("the Patent Office"). For purposes of this paragraph, "prosecution" includes directly or indirectly drafting, amending, advising, or otherwise affecting the scope or maintenance of patent claims.¹⁵ To avoid any doubt, "prosecution" as used in this paragraph does not include representing a party challenging a patent before a domestic or foreign agency (including, but not limited to, a reissue protest, *ex parte* reexamination or *inter partes* reexamination). This Prosecution Bar shall begin when access to "HIGHLY CONFIDENTIAL – ATTORNEYS' EYES ONLY" or "HIGHLY CONFIDENTIAL – SOURCE CODE" information is first received by the affected individual and shall end two (2) years after final termination of this action.

9. SOURCE CODE

(a) To the extent production of source code becomes necessary in this case, a Producing Party may designate source code as "HIGHLY CONFIDENTIAL – SOURCE CODE" if it comprises or includes confidential, proprietary or trade secret source code.

(b) Protected Material designated as "HIGHLY CONFIDENTIAL – SOURCE CODE" shall be subject to all of the protections afforded to "HIGHLY CONFIDENTIAL – ATTORNEYS' EYES ONLY" information, including the Prosecution Bar set forth in Paragraph 8, and may be disclosed only to the individuals to whom "HIGHLY CONFIDENTIAL – ATTORNEYS' EYES ONLY" information may be disclosed,

15. Prosecution includes, for example, original prosecution, reissue and reexamination proceedings.

as set forth in Paragraphs 7.3 and 7.4, with the exception of Designated House Counsel.

(c) Any source code produced in discovery shall be made available for inspection, in a format allowing it to be reasonably reviewed and searched, during normal business hours or at other mutually agreeable times, at an office of the Producing Party's counsel or another mutually agreed upon location. The source code shall be made available for inspection on a secured computer in a secured room without Internet access or network access to other computers, and the Receiving Party shall not copy, remove, or otherwise transfer any portion of the source code onto any recordable media or recordable device. The Producing Party may visually monitor the activities of the Receiving Party's representatives during any source code review, but only to ensure that there is no unauthorized recording, copying, or transmission of the source code.

(d) The Receiving Party may request paper copies of limited portions of source code that are reasonably necessary for the preparation of court filings, pleadings, expert reports, or other papers, or for deposition or trial, but shall not request paper copies for the purpose of reviewing the source code other than electronically as set forth in paragraph (c) in the first instance. The Producing Party shall provide all such source code in paper form, including bates numbers and the label "HIGHLY CONFIDENTIAL – SOURCE CODE." The Producing Party may challenge the amount of source code requested in hard copy form pursuant to the dispute resolution procedure and timeframes set forth in Paragraph 6 whereby the Producing Party is the "Challenging Party" and the Receiving Party is the "Designating Party" for purposes of dispute resolution.

(e) The Receiving Party shall maintain a record of any individual who has inspected any portion of the source code in electronic or paper form. The Receiving Party shall maintain all paper copies of any printed portions of the source code in a secured, locked area. The Receiving Party shall not create any electronic or other images of the paper copies and shall not convert any of the information contained in the paper copies into any electronic format. The Receiving Party shall only make additional paper copies if such additional copies are (1) necessary to prepare court filings, pleadings, or other papers (including a testifying expert's expert report), (2) necessary for deposition, or (3) otherwise necessary for the preparation of its case. Any paper copies used during a deposition shall be retrieved by the Producing Party at the end of each day and must not be given to or left with a court reporter or any other unauthorized individual.

10. PROTECTED MATERIAL SUBPOENAED OR ORDERED PRODUCED IN OTHER LITIGATION

If a Party is served with a subpoena or a court order issued in other litigation that compels disclosure of any information or items designated in this action as “CONFIDENTIAL,” “HIGHLY CONFIDENTIAL – ATTORNEYS’ EYES ONLY,” or “HIGHLY CONFIDENTIAL – SOURCE CODE,” that Party must:

(a) promptly notify in writing the Designating Party. Such notification shall include a copy of the subpoena or court order;

(b) promptly notify in writing the party who caused the subpoena or order to issue in the other litigation that some or all of the material covered by the subpoena or order is subject to this Protective Order. Such notification shall include a copy of this Protective Order; and

(c) cooperate with respect to all reasonable procedures sought to be pursued by the Designating Party whose Protected Material may be affected.¹⁶

If the Designating Party timely seeks a protective order, the Party served with the subpoena or court order shall not produce any information designated in this action as “CONFIDENTIAL,” “HIGHLY CONFIDENTIAL – ATTORNEYS’ EYES ONLY.” or “HIGHLY CONFIDENTIAL – SOURCE CODE” before a determination by the court from which the subpoena or order issued, unless the Party has obtained the Designating Party’s permission. The Designating Party shall bear the burden and expense of seeking protection in that court of its confidential material – and nothing in these provisions should be construed as authorizing or encouraging a Receiving Party in this action to disobey a lawful directive from another court.

11. A NON-PARTY’S PROTECTED MATERIAL SOUGHT TO BE PRODUCED IN THIS LITIGATION

(a) The terms of this Order are applicable to information produced by a Non-Party in this action and designated as “CONFIDENTIAL,” “HIGHLY CONFIDENTIAL – ATTORNEYS’ EYES ONLY,” or “HIGHLY CONFIDENTIAL – SOURCE CODE.” Such information produced by Non-Parties in connection with this litigation is protected by the remedies and relief provided by this Order. Nothing in these provisions should be construed as prohibiting a Non-Party from seeking additional protections.

16. The purpose of imposing these duties is to alert the interested parties to the existence of this Protective Order and to afford the Designating Party in this case an opportunity to try to protect its confidentiality interests in the court from which the subpoena or order issued.

(b) In the event that a Party is required, by a valid discovery request, to produce a Non-Party's confidential information in its possession, and the Party is subject to an agreement with the Non-Party not to produce the Non-Party's confidential information, then the Party shall:

1. promptly notify in writing the Requesting Party and the Non-Party that some or all of the information requested is subject to a confidentiality agreement with a Non-Party;
2. promptly provide the Non-Party with a copy of the Protective Order in this litigation, the relevant discovery request(s), and a reasonably specific description of the information requested; and
3. make the information requested available for inspection by the Non-Party.

(c) If the Non-Party fails to object or seek a protective order from this court within 14 days of receiving the notice and accompanying information, the Receiving Party may produce the Non-Party's confidential information responsive to the discovery request. If the Non-Party timely seeks a protective order, the Receiving Party shall not produce any information in its possession or control that is subject to the confidentiality agreement with the Non-Party before a determination by the court.¹⁷ Absent a court order to the contrary, the Non-Party shall bear the burden and expense of seeking protection in this court of its Protected Material.

12. UNAUTHORIZED DISCLOSURE OF PROTECTED MATERIAL

If a Receiving Party learns that, by inadvertence or otherwise, it has disclosed Protected Material to any person or in any circumstance not authorized under this Protective Order, the Receiving Party must immediately (a) notify in writing the Designating Party of the unauthorized disclosures, (b) use its best efforts to retrieve all unauthorized copies of the Protected Material, (c) inform the person or persons to whom unauthorized disclosures were made of all the terms of this Order, and (d) request such person or persons to execute the "Acknowledgment and Agreement to Be Bound" that is attached hereto as Exhibit A.

¹⁷ The purpose of this provision is to alert the interested parties to the existence of confidentiality rights of a Non-Party and to afford the Non-Party an opportunity to protect its confidentiality interests in this court.

13. INADVERTENT PRODUCTION OF PRIVILEGED OR OTHERWISE PROTECTED MATERIAL

When a Producing Party gives notice to Receiving Parties that certain inadvertently produced material is subject to a claim of privilege or other protection, the obligations of the Receiving Parties are those set forth in Federal Rule of Civil Procedure 26(b)(5)(B). This provision is not intended to modify whatever procedure may be established in an e-discovery order that provides for production without prior privilege review. Pursuant to Federal Rule of Evidence 502(d) and (e), insofar as the parties reach an agreement on the effect of disclosure of a communication or information covered by the attorney-client privilege or work product protection, the parties may incorporate their agreement in a stipulated protective order submitted to the court.

14. MISCELLANEOUS

14.1 Right to Further Relief. Nothing in this Order abridges the right of any person to seek its modification by the court in the future.

14.2 Right to Assert Other Objections. No Party waives any right it otherwise would have to object to disclosing or producing any information or item on any ground not addressed in this Protective Order. Similarly, no Party waives any right to object on any ground to use in evidence of any of the material covered by this Protective Order.

14.3 Export Control. Disclosure of Protected Material shall be subject to all applicable laws and regulations relating to the export of technical data contained in such Protected Material, including the release of such technical data to foreign persons or nationals in the United States or elsewhere. The Producing Party shall be responsible for identifying any such controlled technical data, and the Receiving Party shall take measures necessary to ensure compliance.

14.4 Filing Protected Material. Without written permission from the Designating Party or a court order secured after appropriate notice to all interested persons, a Party may not file in the public record in this action any Protected Material. A Party that seeks to file under seal any Protected Material must comply with Civil Local Rule 79-5. Protected Material may only be filed under seal pursuant to a court order authorizing the sealing of the specific Protected Material at issue. Pursuant to Civil Local Rule 79-5, a sealing order will issue only upon a request establishing that the Protected Material at issue is privileged, protectable as a trade secret, or otherwise entitled to protection under the law. If a Receiving Party's request to file Protected Material under seal pursuant to Civil Local Rule 79-5(e) is denied by the court, then

the Receiving Party may file the Protected Material in the public record pursuant to Civil Local Rule 79-5(e)(2) unless otherwise instructed by the court.

15. FINAL DISPOSITION

Within 60 days after the final disposition of this action, as defined in paragraph 4, each Receiving Party must return all Protected Material to the Producing Party or destroy such material. As used in this subdivision, “all Protected Material” includes all copies, abstracts, compilations, summaries, and any other format reproducing or capturing any of the Protected Material. Whether the Protected Material is returned or destroyed, the Receiving Party must submit a written certification to the Producing Party (and, if not the same person or entity, to the Designating Party) by the 60 day deadline that (1) identifies (by category, where appropriate) all the Protected Material that was returned or destroyed and (2) affirms that the Receiving Party has not retained any copies, abstracts, compilations, summaries or any other format reproducing or capturing any of the Protected Material. Notwithstanding this provision, Counsel are entitled to retain an archival copy of all pleadings, motion papers, trial, deposition, and hearing transcripts, legal memoranda, correspondence, deposition and trial exhibits, expert reports, attorney work product, and consultant and expert work product, even if such materials contain Protected Material. Any such archival copies that contain or constitute Protected Material remain subject to this Protective Order as set forth in Section 4 (DURATION).

IT IS SO ORDERED.

DATED: _____

[Name of Judge]

United States District/Magistrate Judge

EXHIBIT A
ACKNOWLEDGMENT AND AGREEMENT TO BE BOUND

I, _____ [print or type full name], of _____ [print or type full address], declare under penalty of perjury that I have read in its entirety and understand the Protective Order that was issued by the United States District Court for the Northern District of California on _____ [date] in the case of _____ [**insert formal name of the case and the number and initials assigned to it by the court**]. I agree to comply with and to be bound by all the terms of this Protective Order, and I understand and acknowledge that failure to so comply could expose me to sanctions and punishment in the nature of contempt. I solemnly promise that I will not disclose in any manner any information or item that is subject to this Protective Order to any person or entity except in strict compliance with the provisions of this Order.

I further agree to submit to the jurisdiction of the United States District Court for the Northern District of California for the purpose of enforcing the terms of this Protective Order, even if such enforcement proceedings occur after termination of this action.

I hereby appoint _____ [print or type full name] of _____ [print or type full address and telephone number] as my California agent for service of process in connection with this action or any proceedings related to enforcement of this Protective Order.

Date: _____

City and State where sworn and signed: _____

Printed name: _____
[printed name]

Signature: _____
[signature]

Appendix 2.4b

Northern District of California, Stipulated Protective Order for Litigation Involving Patents, Highly Sensitive Confidential Information, and/or Trade Secrets

UNITED STATES DISTRICT COURT
NORTHERN DISTRICT OF CALIFORNIA

Plaintiff,
v.

Defendant.

Case No. C
STIPULATED PROTECTIVE ORDER
FOR LITIGATION INVOLVING
PATENTS, HIGHLY SENSITIVE
CONFIDENTIAL INFORMATION
AND/OR TRADE SECRETS

1. PURPOSES AND LIMITATIONS

Disclosure and discovery activity in this action are likely to involve production of confidential, proprietary, or private information for which special protection from public disclosure and from use for any purpose other than prosecuting this litigation may be warranted. Accordingly, the parties hereby stipulate to and petition the court to enter the following Stipulated Protective Order. The parties acknowledge that this Order does not confer blanket protections on all disclosures or responses to discovery and that the protection it affords from public disclosure and use extends only to the limited information or items that are entitled to confidential treatment under the applicable legal principles. The parties further acknowledge, as set forth in Section 14.4, below, that this Stipulated Protective Order does not entitle them to file confidential information under seal; Civil Local Rule 79-5 sets forth the procedures that must be followed and the standards that will be applied when a party seeks permission from the court to file material under seal.

2. DEFINITIONS

2.1 Challenging Party: a Party or Non-Party that challenges the designation of information or items under this Order.

2.2 “CONFIDENTIAL” Information or Items: information (regardless of how it is generated, stored or maintained) or tangible things that qualify for protection under Federal Rule of Civil Procedure 26(c).

2.3 Counsel (without qualifier): Outside Counsel of Record and House Counsel (as well as their support staff).

[2.4 Optional: Designated House Counsel: House Counsel who seek access to “HIGHLY CONFIDENTIAL – ATTORNEYS’ EYES ONLY” information in this matter.]

2.5 Designating Party: a Party or Non-Party that designates information or items that it produces in disclosures or in responses to discovery as “CONFIDENTIAL” or “HIGHLY CONFIDENTIAL – ATTORNEYS’ EYES ONLY” [*Optional*: or “HIGHLY CONFIDENTIAL – SOURCE CODE”].

2.6 Disclosure or Discovery Material: all items or information, regardless of the medium or manner in which it is generated, stored, or maintained (including, among other things, testimony, transcripts, and tangible things), that are produced or generated in disclosures or responses to discovery in this matter.

2.7 Expert: a person with specialized knowledge or experience in a matter pertinent to the litigation who (1) has been retained by a Party or its counsel to serve as an expert witness or as a consultant in this action, (2) is not a past or current employee of a Party or of a Party’s competitor, and (3) at the time of retention, is not anticipated to become an employee of a Party or of a Party’s competitor.

2.8 “HIGHLY CONFIDENTIAL – ATTORNEYS’ EYES ONLY” Information or Items: extremely sensitive “Confidential Information or Items,” disclosure of which to another Party or Non-Party would create a substantial risk of serious harm that could not be avoided by less restrictive means.

[2.9 *Optional*: “HIGHLY CONFIDENTIAL – SOURCE CODE” Information or Items: extremely sensitive “Confidential Information or Items” representing computer code and associated comments and revision histories, formulas, engineering specifications, or schematics that define or otherwise describe in detail the algorithms or structure of software or hardware designs, disclosure of which to another Party or Non-Party would create a substantial risk of serious harm that could not be avoided by less restrictive means.]

2.10 House Counsel: attorneys who are employees of a party to this action. House Counsel does not include Outside Counsel of Record or any other outside counsel.

2.11 Non-Party: any natural person, partnership, corporation, association, or other legal entity not named as a Party to this action.

2.12 Outside Counsel of Record: attorneys who are not employees of a party to this action but are retained to represent or advise a party to this action and have appeared in this action on behalf of that party or are affiliated with a law firm which has appeared on behalf of that party.

2.13 Party: any party to this action, including all of its officers, directors, employees, consultants, retained experts, and Outside Counsel of Record (and their support staffs).

2.14 Producing Party: a Party or Non-Party that produces Disclosure or Discovery Material in this action.

2.15 Professional Vendors: persons or entities that provide litigation support services (e.g., photocopying, videotaping, translating, preparing exhibits or demonstrations, and organizing, storing, or retrieving data in any form or medium) and their employees and subcontractors.

2.16 Protected Material: any Disclosure or Discovery Material that is designated as “CONFIDENTIAL,” or as “HIGHLY CONFIDENTIAL – ATTORNEYS’ EYES ONLY.” [*Optional*: or as “HIGHLY CONFIDENTIAL – SOURCE CODE.”]

2.17 Receiving Party: a Party that receives Disclosure or Discovery Material from a Producing Party.

3. SCOPE

The protections conferred by this Stipulation and Order cover not only Protected Material (as defined above), but also (1) any information copied or extracted from Protected Material; (2) all copies, excerpts, summaries, or compilations of Protected Material; and (3) any testimony, conversations, or presentations by Parties or their Counsel that might reveal Protected Material. However, the protections conferred by this Stipulation and Order do not cover the following information: (a) any information that is in the public domain at the time of disclosure to a Receiving Party or becomes part of the public domain after its disclosure to a Receiving Party as a result of publication not involving a violation of this Order, including becoming part of the public record through trial or otherwise; and (b) any information known to the Receiving Party prior to the disclosure or obtained by the Receiving Party after the disclosure from a source who obtained the information lawfully and under no obligation of confidentiality to the Designating Party. Any use of Protected Material at trial shall be governed by a separate agreement or order.

4. DURATION

Even after final disposition of this litigation, the confidentiality obligations imposed by this Order shall remain in effect until a Designating Party agrees otherwise in writing or a court order otherwise directs. Final disposition shall be deemed to be the later of (1) dismissal of all claims and defenses in this action, with or without prejudice; and (2) final judgment herein after the completion and exhaustion of all appeals, rehearings, remands, trials, or reviews of this action, including the time limits for filing any motions or applications for extension of time pursuant to applicable law.

5. DESIGNATING PROTECTED MATERIAL

5.1 Exercise of Restraint and Care in Designating Material for Protection. Each Party or Non-Party that designates information or items for protection under this Order must take care to limit any such designation to specific material that qualifies under the appropriate standards. To the extent it is practical to do so, the Designating Party must designate for protection only those parts of material, documents, items, or oral or written communications that qualify – so that other portions of the material, documents, items, or communications for which protection is not warranted are not swept unjustifiably within the ambit of this Order.

Mass, indiscriminate, or routinized designations are prohibited. Designations that are shown to be clearly unjustified or that have been made for an improper purpose (e.g., to unnecessarily encumber or retard the case development process or to impose unnecessary expenses and burdens on other parties) expose the Designating Party to sanctions.

If it comes to a Designating Party's attention that information or items that it designated for protection do not qualify for protection at all or do not qualify for the level of protection initially asserted, that Designating Party must promptly notify all other parties that it is withdrawing the mistaken designation.

5.2 Manner and Timing of Designations. Except as otherwise provided in this Order (see, e.g., second paragraph of section 5.2(a) below), or as otherwise stipulated or ordered, Disclosure or Discovery

Material that qualifies for protection under this Order must be clearly so designated before the material is disclosed or produced.

Designation in conformity with this Order requires:

(a) for information in documentary form (e.g., paper or electronic documents, but excluding transcripts of depositions or other pretrial or trial proceedings), that the Producing Party affix the legend "CONFIDENTIAL" or "HIGHLY CONFIDENTIAL – ATTORNEYS' EYES ONLY" [*Optional:* or "HIGHLY CONFIDENTIAL – SOURCE CODE"] to each page that contains protected material. If only a portion or portions of the material on a page qualifies for protection, the Producing Party also must clearly identify the protected portion(s) (e.g., by making appropriate markings in the margins) and must specify, for each portion, the level of protection being asserted.

A Party or Non-Party that makes original documents or materials available for inspection need not designate them for protection until after the inspecting Party has indicated which material it would like copied and produced. During the inspection and before the designation, all of the material made available for inspection shall be deemed "HIGHLY CONFIDENTIAL – ATTORNEYS' EYES ONLY." After the inspecting Party has identified the documents it wants copied and produced, the

Producing Party must determine which documents, or portions thereof, qualify for protection under this Order. Then, before producing the specified documents, the Producing Party must affix the appropriate legend (“CONFIDENTIAL” or “HIGHLY CONFIDENTIAL – ATTORNEYS’ EYES ONLY” [*Optional:* or “HIGHLY CONFIDENTIAL – SOURCE CODE”]) to each page that contains Protected Material. If only a portion or portions of the material on a page qualifies for protection, the Producing Party also must clearly identify the protected portion(s) (e.g., by making appropriate markings in the margins) and must specify, for each portion, the level of protection being asserted.

(b) for testimony given in deposition or in other pretrial or trial proceedings, that the Designating Party identify on the record, before the close of the deposition, hearing, or other proceeding, all protected testimony and specify the level of protection being asserted. When it is impractical to identify separately each portion of testimony that is entitled to protection and it appears that substantial portions of the testimony may qualify for protection, the Designating Party may invoke on the record (before the deposition, hearing, or other proceeding is concluded) a right to have up to 21 days to identify the specific portions of the testimony as to which protection is sought and to specify the level of protection being asserted. Only those portions of the testimony that are appropriately designated for protection within the 21 days shall be covered by the provisions of this Stipulated Protective Order. Alternatively, a Designating Party may specify, at the deposition or up to 21 days afterwards if that period is properly invoked, that the entire transcript shall be treated as “CONFIDENTIAL” or “HIGHLY CONFIDENTIAL – ATTORNEYS’ EYES ONLY.”

Parties shall give the other parties notice if they reasonably expect a deposition, hearing or other proceeding to include Protected Material so that the other parties can ensure that only authorized individuals who have signed the “Acknowledgment and Agreement to Be Bound” (Exhibit A) are present at those proceedings. The use of a document as an exhibit at a deposition shall not in any way affect its designation as “CONFIDENTIAL” or “HIGHLY CONFIDENTIAL – ATTORNEYS’ EYES ONLY.”

Transcripts containing Protected Material shall have an obvious legend on the title page that the transcript contains Protected Material, and the title page shall be followed by a list of all pages (including line numbers as appropriate) that have been designated as Protected Material and the level of protection being asserted by the Designating Party. The Designating Party shall inform the court reporter of these requirements. Any transcript that is prepared before the expiration of a 21-day period for designation shall be treated during that period as if it had been designated “HIGHLY CONFIDENTIAL – ATTORNEYS’ EYES ONLY” in its entirety unless otherwise agreed. After the expiration of that period, the transcript shall be treated only as actually designated.

(c) for information produced in some form other than documentary and for any other tangible items, that the Producing Party affix in a prominent place on the exterior of the container or containers in which the information or item is stored the legend “CONFIDENTIAL” or “HIGHLY CONFIDENTIAL – ATTORNEYS’ EYES ONLY” [*Optional*: or “HIGHLY CONFIDENTIAL – SOURCE CODE”]. If only a portion or portions of the information or item warrant protection, the Producing Party, to the extent practicable, shall identify the protected portion(s) and specify the level of protection being asserted.

5.3 Inadvertent Failures to Designate. If timely corrected, an inadvertent failure to designate qualified information or items does not, standing alone, waive the Designating Party’s right to secure protection under this Order for such material. Upon timely correction of a designation, the Receiving Party must make reasonable efforts to assure that the material is treated in accordance with the provisions of this Order.

6. CHALLENGING CONFIDENTIALITY DESIGNATIONS

6.1 Timing of Challenges. Any Party or Non-Party may challenge a designation of confidentiality at any time. Unless a prompt challenge to a Designating Party’s confidentiality designation is necessary to avoid foreseeable, substantial unfairness, unnecessary economic burdens, or a significant disruption or delay of the litigation, a Party does not waive its right to challenge a confidentiality designation by electing not to mount a challenge promptly after the original designation is disclosed.

6.2 Meet and Confer. The Challenging Party shall initiate the dispute resolution process by providing written notice of each designation it is challenging and describing the basis for each challenge. To avoid ambiguity as to whether a challenge has been made, the written notice must recite that the challenge to confidentiality is being made in accordance with this specific paragraph of the Protective Order. The parties shall attempt to resolve each challenge in good faith and must begin the process by conferring directly (in voice to voice dialogue; other forms of communication are not sufficient) within 14 days of the date of service of notice. In conferring, the Challenging Party must explain the basis for its belief that the confidentiality designation was not proper and must give the Designating Party an opportunity to review the designated material, to reconsider the circumstances, and, if no change in designation is offered, to explain the basis for the chosen designation. A Challenging Party may proceed to the next stage of the challenge process only if it has engaged in this meet and confer process first or establishes that the Designating Party is unwilling to participate in the meet and confer process in a timely manner.

6.3 Judicial Intervention. If the Parties cannot resolve a challenge without court intervention, the Designating Party shall file and serve a motion to retain confidentiality under Civil Local Rule 7 (and in compliance with Civil Local Rule 79-5, if applicable) within 21 days of the initial notice of challenge or within 14 days of the parties agreeing that the meet and confer process will not resolve their dispute, whichever is

earlier.¹⁸ Each such motion must be accompanied by a competent declaration affirming that the movant has complied with the meet and confer requirements imposed in the preceding paragraph. Failure by the Designating Party to make such a motion including the required declaration within 21 days (or 14 days, if applicable) shall automatically waive the confidentiality designation for each challenged designation. In addition, the Challenging Party may file a motion challenging a confidentiality designation at any time if there is good cause for doing so, including a challenge to the designation of a deposition transcript or any portions thereof. Any motion brought pursuant to this provision must be accompanied by a competent declaration affirming that the movant has complied with the meet and confer requirements imposed by the preceding paragraph.

The burden of persuasion in any such challenge proceeding shall be on the Designating Party. Frivolous challenges and those made for an improper purpose (e.g., to harass or impose unnecessary expenses and burdens on other parties) may expose the Challenging Party to sanctions. Unless the Designating Party has waived the confidentiality designation by failing to file a motion to retain confidentiality as described above, all parties shall continue to afford the material in question the level of protection to which it is entitled under the Producing Party's designation until the court rules on the challenge.

7. ACCESS TO AND USE OF PROTECTED MATERIAL

7.1 Basic Principles. A Receiving Party may use Protected Material that is disclosed or produced by another Party or by a Non-Party in connection with this case only for prosecuting, defending, or attempting to settle this litigation. Such Protected Material may be disclosed only to the categories of persons and under the conditions described in this Order. When the litigation has been terminated, a Receiving Party must comply with the provisions of section 15 below (FINAL DISPOSITION).

Protected Material must be stored and maintained by a Receiving Party at a location and in a secure manner¹⁹ that ensures that access is limited to the persons authorized under this Order.

7.2 Disclosure of "CONFIDENTIAL" Information or Items. Unless otherwise ordered by the court or permitted in writing by the Designating Party, a Receiving Party may disclose any information or item designated "CONFIDENTIAL" only to:

18. Alternative: It may be appropriate in certain circumstances for the parties to agree to shift the burden to move on the Challenging Party after a certain number of challenges are made to avoid an abuse of the process. The burden of persuasion would remain on the Designating Party.

19. It may be appropriate under certain circumstances to require the Receiving Party to store any electronic Protected Material in password-protected form.

(a) the Receiving Party's Outside Counsel of Record in this action, as well as employees of said Outside Counsel of Record to whom it is reasonably necessary to disclose the information for this litigation and who have signed the "Acknowledgment and Agreement to Be Bound" that is attached hereto as Exhibit A;

(b) the officers, directors, and employees (including House Counsel) of the Receiving Party to whom disclosure is reasonably necessary for this litigation and who have signed the "Acknowledgment and Agreement to Be Bound" (Exhibit A);

(c) Experts (as defined in this Order) of the Receiving Party to whom disclosure is reasonably necessary for this litigation and who have signed the "Acknowledgment and Agreement to Be Bound" (Exhibit A);

(d) the court and its personnel;

(e) court reporters and their staff, professional jury or trial consultants, and Professional Vendors to whom disclosure is reasonably necessary for this litigation and who have signed the "Acknowledgment and Agreement to Be Bound" (Exhibit A);

(f) during their depositions, witnesses in the action to whom disclosure is reasonably necessary and who have signed the "Acknowledgment and Agreement to Be Bound" (Exhibit A), unless otherwise agreed by the Designating Party or ordered by the court. Pages of transcribed deposition testimony or exhibits to depositions that reveal Protected Material must be separately bound by the court reporter and may not be disclosed to anyone except as permitted under this Stipulated Protective Order.

(g) the author or recipient of a document containing the information or a custodian or other person who otherwise possessed or knew the information.

7.3 Disclosure of "HIGHLY CONFIDENTIAL – ATTORNEYS' EYES ONLY" [Optional: and "HIGHLY CONFIDENTIAL – SOURCE CODE"] Information or Items. Unless otherwise ordered by the court or permitted in writing by the Designating Party, a Receiving Party may disclose any information or item designated "HIGHLY CONFIDENTIAL – ATTORNEYS' EYES ONLY" [Optional: or "HIGHLY CONFIDENTIAL – SOURCE CODE"] only to:

(a) the Receiving Party's Outside Counsel of Record in this action, as well as employees of said Outside Counsel of Record to whom it is reasonably necessary to disclose the information for this litigation and who have signed the "Acknowledgment and Agreement to Be Bound" that is attached hereto as Exhibit A;

[(b) *Optional as deemed appropriate in case-specific circumstances:* Designated House Counsel of the Receiving Party²⁰ (1) who has no involvement in competitive decision-making, (2) to whom disclosure is reasonably necessary for this litigation, (3) who has signed the “Acknowledgment and Agreement to Be Bound” (Exhibit A), and (4) as to whom the procedures set forth in paragraph 7.4(a)(1), below, have been followed];²¹

(c) Experts of the Receiving Party (1) to whom disclosure is reasonably necessary for this litigation, (2) who have signed the “Acknowledgment and Agreement to Be Bound” (Exhibit A), and (3) as to whom the procedures set forth in paragraph 7.4(a)(2), below, have been followed];

(d) the court and its personnel;

(e) court reporters and their staff, professional jury or trial consultants,²² and Professional Vendors to whom disclosure is reasonably necessary for this litigation and who have signed the “Acknowledgment and Agreement to Be Bound” (Exhibit A); and

(f) the author or recipient of a document containing the information or a custodian or other person who otherwise possessed or knew the information.

7.4 Procedures for Approving or Objecting to Disclosure of “HIGHLY CONFIDENTIAL – ATTORNEYS’ EYES ONLY” [*Optional:* or “HIGHLY CONFIDENTIAL – SOURCE CODE”] Information or Items to Designated House Counsel²³ or Experts.²⁴

20. It may be appropriate under certain circumstances to limit the number of Designated House Counsel who may access “HIGHLY CONFIDENTIAL – ATTORNEYS’ EYES ONLY” information under this provision.

21. This Order contemplates that Designated House Counsel shall not have access to any information or items designated “HIGHLY CONFIDENTIAL – SOURCE CODE.” It may also be appropriate under certain circumstances to limit how Designated House Counsel may access “HIGHLY CONFIDENTIAL – ATTORNEYS’ EYES ONLY” information. For example, Designated House Counsel may be limited to viewing “HIGHLY CONFIDENTIAL – ATTORNEYS’ EYES ONLY” information only if it is filed with the court under seal, or in the presence of Outside Counsel of Record at their offices.

22. *Alternative:* The parties may wish to allow disclosure of information not only to professional jury or trial consultants, but also to mock jurors, to further trial preparation. In that situation, the parties may wish to draft a simplified, precisely tailored Undertaking for mock jurors to sign.

23. *Alternative:* The parties may exchange names of a certain number of Designated House Counsel instead of following this procedure.

24. *Alternative:* “CONFIDENTIAL” or “HIGHLY CONFIDENTIAL – ATTORNEYS’ EYES ONLY” information or items may be disclosed to an Expert without disclosure of the

(a)(1) Unless otherwise ordered by the court or agreed to in writing by the Designating Party, a Party that seeks to disclose to Designated House Counsel any information or item that has been designated “HIGHLY CONFIDENTIAL – ATTORNEYS’ EYES ONLY” pursuant to paragraph 7.3(b) first must make a written request to the Designating Party that (1) sets forth the full name of the Designated House Counsel and the city and state of his or her residence, and (2) describes the Designated House Counsel’s current and reasonably foreseeable future primary job duties and responsibilities in sufficient detail to determine if House Counsel is involved, or may become involved, in any competitive decision-making.²⁵

(a)(2) Unless otherwise ordered by the court or agreed to in writing by the Designating Party, a Party that seeks to disclose to an Expert (as defined in this Order) any information or item that has been designated “HIGHLY CONFIDENTIAL – ATTORNEYS’ EYES ONLY” [*Optional*: or “HIGHLY CONFIDENTIAL – SOURCE CODE”] pursuant to paragraph 7.3(c) first must make a written request to the Designating Party that (1) identifies the general categories of “HIGHLY CONFIDENTIAL – ATTORNEYS’ EYES ONLY” [*Optional*: or “HIGHLY CONFIDENTIAL – SOURCE CODE”] information that the Receiving Party seeks permission to disclose to the Expert, (2) sets forth the full name of the Expert and the city and state of his or her primary residence, (3) attaches a copy of the Expert’s current resume, (4) identifies the Expert’s current employer(s), (5) identifies each person or entity from whom the Expert has received compensation or funding for work in his or her areas of expertise or to whom the expert has provided professional services, including in connection with a litigation, at any time during the preceding five years,²⁶ and (6) identifies (by name and number of the case, filing date, and location of court) any litigation in connection with which the Expert has offered expert testimony, including through a declaration, report, or testimony at a deposition or trial, during the preceding five years.²⁷

identity of the Expert as long as the Expert is not a current officer, director, or employee of a competitor of a Party or anticipated to become one.

25. It may be appropriate in certain circumstances to require any Designated House Counsel who receives “HIGHLY CONFIDENTIAL – ATTORNEYS’ EYES ONLY” information pursuant to this Order to disclose any relevant changes in job duties or responsibilities prior to final disposition of the litigation to allow the Designating Party to evaluate any later-arising competitive decision-making responsibilities.

26. If the Expert believes any of this information is subject to a confidentiality obligation to a third-party, then the Expert should provide whatever information the Expert believes can be disclosed without violating any confidentiality agreements, and the Party seeking to disclose to the Expert shall be available to meet and confer with the Designating Party regarding any such engagement.

27. It may be appropriate in certain circumstances to restrict the Expert from undertaking certain limited work prior to the termination of the litigation that could

(b) A Party that makes a request and provides the information specified in the preceding respective paragraphs may disclose the subject Protected Material to the identified Designated House Counsel or Expert unless, within 14 days of delivering the request, the Party receives a written objection from the Designating Party. Any such objection must set forth in detail the grounds on which it is based.

(c) A Party that receives a timely written objection must meet and confer with the Designating Party (through direct voice to voice dialogue) to try to resolve the matter by agreement within seven days of the written objection. If no agreement is reached, the Party seeking to make the disclosure to Designated House Counsel or the Expert may file a motion as provided in Civil Local Rule 7 (and in compliance with Civil Local Rule 79-5, if applicable) seeking permission from the court to do so. Any such motion must describe the circumstances with specificity, set forth in detail the reasons why the disclosure to Designated House Counsel or the Expert is reasonably necessary, assess the risk of harm that the disclosure would entail, and suggest any additional means that could be used to reduce that risk. In addition, any such motion must be accompanied by a competent declaration describing the parties' efforts to resolve the matter by agreement (i.e., the extent and the content of the meet and confer discussions) and setting forth the reasons advanced by the Designating Party for its refusal to approve the disclosure.

In any such proceeding, the Party opposing disclosure to Designated House Counsel or the Expert shall bear the burden of proving that the risk of harm that the disclosure would entail (under the safeguards proposed) outweighs the Receiving Party's need to disclose the Protected Material to its Designated House Counsel or Expert.

8. PROSECUTION BAR [*Optional*]

Absent written consent from the Producing Party, any individual who receives access to "HIGHLY CONFIDENTIAL – ATTORNEYS' EYES ONLY" [*Optional*: or "HIGHLY CONFIDENTIAL – SOURCE CODE"] information shall not be involved in the prosecution of patents or patent applications relating to [insert subject matter of the invention and of highly confidential technical information to be produced], including without limitation the patents asserted in this action and any patent or application claiming priority to or otherwise related to the patents asserted in this action, before any foreign or domestic agency, including the United States Patent and Trademark Office ("the Patent Office").²⁸ For purposes of this paragraph, "pros-

foreseeably result in an improper use of the Designating Party's "HIGHLY CONFIDENTIAL – ATTORNEYS' EYES ONLY" information.

28. It may be appropriate under certain circumstances to require Outside and House Counsel who receive access to "HIGHLY CONFIDENTIAL – ATTORNEYS' EYES ONLY" information to implement an "Ethical Wall."

ecution” includes directly or indirectly drafting, amending, advising, or otherwise affecting the scope or maintenance of patent claims.²⁹ To avoid any doubt, “prosecution” as used in this paragraph does not include representing a party challenging a patent before a domestic or foreign agency (including, but not limited to, a reissue protest, *ex parte* reexamination or *inter partes* reexamination). This Prosecution Bar shall begin when access to “HIGHLY CONFIDENTIAL – ATTORNEYS’ EYES ONLY” [Optional: or “HIGHLY CONFIDENTIAL – SOURCE CODE”] information is first received by the affected individual and shall end two (2) years after final termination of this action.³⁰

9. SOURCE CODE [Optional]

(a) To the extent production of source code becomes necessary in this case, a Producing Party may designate source code as “HIGHLY CONFIDENTIAL – SOURCE CODE” if it comprises or includes confidential, proprietary or trade secret source code.

(b) Protected Material designated as “HIGHLY CONFIDENTIAL – SOURCE CODE” shall be subject to all of the protections afforded to “HIGHLY CONFIDENTIAL – ATTORNEYS’ EYES ONLY” information [Optional: including the Prosecution Bar set forth in Paragraph 8], and may be disclosed only to the individuals to whom “HIGHLY CONFIDENTIAL – ATTORNEYS’ EYES ONLY” information may be disclosed, as set forth in Paragraphs 7.3 and 7.4, with the exception of Designated House Counsel.³¹

(c) Any source code produced in discovery shall be made available for inspection, in a format allowing it to be reasonably reviewed and searched, during normal business hours or at other mutually agreeable times, at an office of the Producing Party’s counsel or another mutually agreed upon location.³² The source code shall be made

29. Prosecution includes, for example, original prosecution, reissue and reexamination proceedings.

30. *Alternative:* It may be appropriate for the Prosecution Bar to apply only to individuals who receive access to another party’s “HIGHLY CONFIDENTIAL – ATTORNEYS’ EYES ONLY” technical or source code information pursuant to this Order, such as under circumstances where one or more parties is not expected to produce “HIGHLY CONFIDENTIAL – ATTORNEYS’ EYES ONLY” information that is technical in nature or “HIGHLY CONFIDENTIAL – SOURCE CODE” information,

31. It may be appropriate under certain circumstances to allow House Counsel access to derivative materials including “HIGHLY CONFIDENTIAL – SOURCE CODE” information, such as exhibits to motions or expert reports,

32. *Alternative:* Any source code produced in discovery shall be made available for inspection in a format through which it could be reasonably reviewed and searched during normal business hours or other mutually agreeable times at a location that is reasonably convenient for the Receiving Party and any experts to whom the source code may be

available for inspection on a secured computer in a secured room without Internet access or network access to other computers, and the Receiving Party shall not copy, remove, or otherwise transfer any portion of the source code onto any recordable media or recordable device. The Producing Party may visually monitor the activities of the Receiving Party's representatives during any source code review, but only to ensure that there is no unauthorized recording, copying, or transmission of the source code.³³

(d) The Receiving Party may request paper copies of limited portions of source code that are reasonably necessary for the preparation of court filings, pleadings, expert reports, or other papers, or for deposition or trial, but shall not request paper copies for the purposes of reviewing the source code other than electronically as set forth in paragraph (c) in the first instance. The Producing Party shall provide all such source code in paper form including bates numbers and the label "HIGHLY CONFIDENTIAL - SOURCE CODE." The Producing Party may challenge the amount of source code requested in hard copy form pursuant to the dispute resolution procedure and timeframes set forth in Paragraph 6 whereby the Producing Party is the "Challenging Party" and the Receiving Party is the "Designating Party" for purposes of dispute resolution.

(e) The Receiving Party shall maintain a record of any individual who has inspected any portion of the source code in electronic or paper form. The Receiving Party shall maintain all paper copies of any printed portions of the source code in a secured, locked area. The Receiving Party shall not create any electronic or other images of the paper copies and shall not convert any of the information contained in the paper copies into any electronic format. The Receiving Party shall only make additional paper copies if such additional copies are (1) necessary to prepare court filings, pleadings, or other papers (including a testifying expert's expert report), (2) necessary for deposition, or (3) otherwise necessary for the preparation of its case. Any paper copies used during a deposition shall be retrieved by the Producing Party at the end of each day and must not be given to or left with a court reporter or any other unauthorized individual.³⁴

disclosed. This alternative may be appropriate if the Producing Party and/or its counsel are located in a different jurisdiction than counsel and/or experts for the Receiving Party.

33. It may be appropriate under certain circumstances to require the Receiving Party to keep a paper log indicating the names of any individuals inspecting the source code and dates and times of inspection, and the names of any individuals to whom paper copies of portions of source code are provided.

34. The nature of the source code at issue in a particular case may warrant additional protections or restrictions. For example, it may be appropriate under certain circumstances to require the Receiving Party to provide notice to the Producing Party before including "HIGHLY CONFIDENTIAL - SOURCE CODE" information in a court filing, pleading, or expert report.

10. PROTECTED MATERIAL SUBPOENAED OR ORDERED PRODUCED IN OTHER LITIGATION

If a Party is served with a subpoena or a court order issued in other litigation that compels disclosure of any information or items designated in this action as “CONFIDENTIAL” or “HIGHLY CONFIDENTIAL – ATTORNEYS’ EYES ONLY” [*Optional*: or “HIGHLY CONFIDENTIAL – SOURCE CODE”] that Party must:

(a) promptly notify in writing the Designating Party. Such notification shall include a copy of the subpoena or court order;

(b) promptly notify in writing the party who caused the subpoena or order to issue in the other litigation that some or all of the material covered by the subpoena or order is subject to this Protective Order. Such notification shall include a copy of this Stipulated Protective Order; and

(c) cooperate with respect to all reasonable procedures sought to be pursued by the Designating Party whose Protected Material may be affected.³⁵

If the Designating Party timely seeks a protective order, the Party served with the subpoena or court order shall not produce any information designated in this action as “CONFIDENTIAL” or “HIGHLY CONFIDENTIAL – ATTORNEYS’ EYES ONLY” [*Optional*: or “HIGHLY CONFIDENTIAL – SOURCE CODE”] before a determination by the court from which the subpoena or order issued, unless the Party has obtained the Designating Party’s permission. The Designating Party shall bear the burden and expense of seeking protection in that court of its confidential material – and nothing in these provisions should be construed as authorizing or encouraging a Receiving Party in this action to disobey a lawful directive from another court.

11. A NON-PARTY’S PROTECTED MATERIAL SOUGHT TO BE PRODUCED IN THIS LITIGATION

(a) The terms of this Order are applicable to information produced by a Non-Party in this action and designated as “CONFIDENTIAL” or “HIGHLY CONFIDENTIAL – ATTORNEYS’ EYES ONLY” [*Optional*: or “HIGHLY CONFIDENTIAL – SOURCE CODE”]. Such information produced by Non-Parties in connection with this litigation is protected by the remedies and relief provided by this Order. Nothing in these provisions should be construed as prohibiting a Non-Party from seeking additional protections.

(b) In the event that a Party is required, by a valid discovery request, to produce a Non-Party’s confidential information in its possession, and the Party is subject to

35. The purpose of imposing these duties is to alert the interested parties to the existence of this Protective Order and to afford the Designating Party in this case an opportunity to try to protect its confidentiality interests in the court from which the subpoena or order issued.

an agreement with the Non-Party not to produce the Non-Party's confidential information, then the Party shall:

1. promptly notify in writing the Requesting Party and the Non-Party that some or all of the information requested is subject to a confidentiality agreement with a Non-Party;
2. promptly provide the Non-Party with a copy of the Stipulated Protective Order in this litigation, the relevant discovery request(s), and a reasonably specific description of the information requested; and
3. make the information requested available for inspection by the Non-Party.

(c) If the Non-Party fails to object or seek a protective order from this court within 14 days of receiving the notice and accompanying information, the Receiving Party may produce the Non-Party's confidential information responsive to the discovery request. If the Non-Party timely seeks a protective order, the Receiving Party shall not produce any information in its possession or control that is subject to the confidentiality agreement with the Non-Party before a determination by the court.³⁶ Absent a court order to the contrary, the Non-Party shall bear the burden and expense of seeking protection in this court of its Protected Material.

12. UNAUTHORIZED DISCLOSURE OF PROTECTED MATERIAL

If a Receiving Party learns that, by inadvertence or otherwise, it has disclosed Protected Material to any person or in any circumstance not authorized under this Stipulated Protective Order, the Receiving Party must immediately (a) notify in writing the Designating Party of the unauthorized disclosures, (b) use its best efforts to retrieve all unauthorized copies of the Protected Material, (c) inform the person or persons to whom unauthorized disclosures were made of all the terms of this Order, and (d) request such person or persons to execute the "Acknowledgment and Agreement to Be Bound" that is attached hereto as Exhibit A.

13. INADVERTENT PRODUCTION OF PRIVILEGED OR OTHERWISE PROTECTED MATERIAL

When a Producing Party gives notice to Receiving Parties that certain inadvertently produced material is subject to a claim of privilege or other protection, the obligations of the Receiving Parties are those set forth in Federal Rule of Civil Procedure 26(b)(5)(B).³⁷ This provision is not intended to modify whatever procedure

36. The purpose of this provision is to alert the interested parties to the existence of confidentiality rights of a Non-Party and to afford the Non-Party an opportunity to protect its confidentiality interests in this court.

37. *Alternative:* The parties may agree that the recipient of an inadvertent production may not "sequester" or in any way use the document(s) pending resolution of a challenge to

may be established in an e-discovery order that provides for production without prior privilege review. Pursuant to Federal Rule of Evidence 502(d) and (e), insofar as the parties reach an agreement on the effect of disclosure of a communication or information covered by the attorney-client privilege or work product protection, the parties may incorporate their agreement in the stipulated protective order submitted to the court.

14. MISCELLANEOUS

14.1 Right to Further Relief. Nothing in this Order abridges the right of any person to seek its modification by the court in the future.

14.2 Right to Assert Other Objections. By stipulating to the entry of this Protective Order no Party waives any right it otherwise would have to object to disclosing or producing any information or item on any ground not addressed in this Stipulated Protective Order. Similarly, no Party waives any right to object on any ground to use in evidence of any of the material covered by this Protective Order.

[14.3 Optional: Export Control. Disclosure of Protected Material shall be subject to all applicable laws and regulations relating to the export of technical data contained in such Protected Material, including the release of such technical data to foreign persons or nationals in the United States or elsewhere. The Producing Party shall be responsible for identifying any such controlled technical data, and the Receiving Party shall take measures necessary to ensure compliance.]

14.4 Filing Protected Material. Without written permission from the Designating Party or a court order secured after appropriate notice to all interested persons, a Party may not file in the public record in this action any Protected Material. A Party that seeks to file under seal any Protected Material must comply with Civil Local Rule 79-5. Protected Material may only be filed under seal pursuant to a court order authorizing the sealing of the specific Protected Material at issue. Pursuant to Civil Local Rule 79-5, a sealing order will issue only upon a request establishing that the Protected Material at issue is privileged, protectable as a trade secret, or otherwise

the claim of privilege or other protection to the extent it would be otherwise allowed by Federal Rule of Civil Procedure 26(b)(5)(B) as amended in 2006. This could include a restriction against “presenting” the document(s) to the court to challenge the privilege claim as may otherwise be allowed under Rule 26(b)(5)(B) subject to ethical obligations.

An alternate provision could state: “If information is produced in discovery that is subject to a claim of privilege or of protection as trial-preparation material, the party making the claim may notify any party that received the information of the claim and the basis for it. After being notified, a party must promptly return or destroy the specified information and any copies it has and may not sequester, use or disclose the information until the claim is resolved. This includes a restriction against presenting the information to the court for a determination of the claim.”

entitled to protection under the law. If a Receiving Party’s request to file Protected Material under seal pursuant to Civil Local Rule 79-5(e) is denied by the court, then the Receiving Party may file the Protected Material in the public record pursuant to Civil Local Rule 79-5(e)(2) unless otherwise instructed by the court.

15. FINAL DISPOSITION

Within 60 days after the final disposition of this action, as defined in paragraph 4, each Receiving Party must return all Protected Material to the Producing Party or destroy such material. As used in this subdivision, “all Protected Material” includes all copies, abstracts, compilations, summaries, and any other format reproducing or capturing any of the Protected Material. Whether the Protected Material is returned or destroyed, the Receiving Party must submit a written certification to the Producing Party (and, if not the same person or entity, to the Designating Party) by the 60-day deadline that (1) identifies (by category, where appropriate) all the Protected Material that was returned or destroyed and (2) affirms that the Receiving Party has not retained any copies, abstracts, compilations, summaries or any other format reproducing or capturing any of the Protected Material. Notwithstanding this provision, Counsel are entitled to retain an archival copy of all pleadings, motion papers, trial, deposition, and hearing transcripts, legal memoranda, correspondence, deposition and trial exhibits, expert reports, attorney work product, and consultant and expert work product, even if such materials contain Protected Material. Any such archival copies that contain or constitute Protected Material remain subject to this Protective Order as set forth in Section 4 (DURATION).

IT IS SO STIPULATED, THROUGH COUNSEL OF RECORD.

DATED: _____

Attorneys for Plaintiff

DATED: _____

Attorneys for Defendant

PURSUANT TO STIPULATION, IT IS SO ORDERED.

DATED: _____

[Name of Judge]

United States District/Magistrate Judge

EXHIBIT A

ACKNOWLEDGMENT AND AGREEMENT TO BE BOUND

I, _____ [print or type full name], of _____ [print or type full address], declare under penalty of perjury that I have read in its entirety and understand the Stipulated Protective Order that was issued by the United States District Court for the Northern District of California on [date] in the case of _____ [**insert formal name of the case and the number and initials assigned to it by the court**]. I agree to comply with and to be bound by all the terms of this Stipulated Protective Order and I understand and acknowledge that failure to so comply could expose me to sanctions and punishment in the nature of contempt. I solemnly promise that I will not disclose in any manner any information or item that is subject to this Stipulated Protective Order to any person or entity except in strict compliance with the provisions of this Order.

I further agree to submit to the jurisdiction of the United States District Court for the Northern District of California for the purpose of enforcing the terms of this Stipulated Protective Order, even if such enforcement proceedings occur after termination of this action.

I hereby appoint _____ [print or type full name] of _____ [print or type full address and telephone number] as my California agent for service of process in connection with this action or any proceedings related to enforcement of this Stipulated Protective Order.

Date: _____

City and State where sworn and signed: _____

Printed name: _____
[printed name]

Signature: _____
[signature]

Appendix 2.4c Model Protective Order from the Northern District of Illinois

IN THE UNITED STATES DISTRICT COURT FOR THE NORTHERN
DISTRICT OF ILLINOIS EASTERN DIVISION

_____)	
Plaintiff[s],)	
)	
)	
vs.)	Case No. _____
)	
_____)	
Defendant[s].)	

PROTECTIVE ORDER

The Court enters the following protective order pursuant to Federal Rule of Civil Procedure 26(c)(1).

1. Findings: The Court finds that the parties to this case may request or produce information involving trade secrets or confidential research and development or commercial information, the disclosure of which is likely to cause harm to the party producing such information.

2. Definitions:

a. “Party” means a named party in this case. “Person” means an individual or an entity. “Producer” means a person who produces information via the discovery process in this case. “Recipient” means a person who receives information via the discovery process in this case.

b. “Confidential” information is information concerning a person’s business operations, processes, and technical and development information within the scope of Rule 26(c)(1)(G), the disclosure of which is likely to harm that person’s competitive position, or the disclosure of which would contravene an obligation of confidentiality to a third person or to a Court.

c. “Highly Confidential” information is information within the scope of Rule 26(c)(1)(G) that is current or future business or technical trade secrets and plans more sensitive or strategic than Confidential information, the disclosure of which is likely to significantly harm that person’s competitive position, or the disclosure of which would contravene an obligation of confidentiality to a third person or to a Court.

d. Information is not Confidential or Highly Confidential if it is disclosed in a printed publication, is known to the public, was known to the recipient without obligation of confidentiality before the producer disclosed it, or is or becomes known to the recipient by means not constituting a breach of this Order. Information is like-

wise not Confidential or Highly Confidential if a person lawfully obtained it independently of this litigation.

3. Designation of information as Confidential or Highly Confidential:

a. A person's designation of information as Confidential or Highly Confidential means that the person believes in good faith, upon reasonable inquiry, that the information qualifies as such.

b. A person designates information in a document or thing as Confidential or Highly Confidential by clearly and prominently marking it on its face as "CONFIDENTIAL" or "HIGHLY CONFIDENTIAL." A producer may make documents or things containing Confidential or Highly Confidential information available for inspection and copying without marking them as confidential without forfeiting a claim of confidentiality, so long as the producer causes copies of the documents or things to be marked as Confidential or Highly Confidential before providing them to the recipient.

c. A person designates information in deposition testimony as Confidential or Highly Confidential by stating on the record at the deposition that the information is Confidential or Highly Confidential or by advising the opposing party and the stenographer and videographer in writing, within fourteen days after receipt of the deposition transcript, that the information is Confidential or Highly Confidential.

d. A person's failure to designate a document, thing, or testimony as Confidential or Highly Confidential does not constitute forfeiture of a claim of confidentiality as to any other document, thing, or testimony.

e. A person who has designated information as Confidential or Highly Confidential may withdraw the designation by written notification to all parties in the case.

f. If a party disputes a producer's designation of information as Confidential or Highly Confidential, the party shall notify the producer in writing of the basis for the dispute, identifying the specific document[s] or thing[s] as to which the designation is disputed and proposing a new designation for such materials. The party and the producer shall then meet and confer to attempt to resolve the dispute without involvement of the Court. If they cannot resolve the dispute, the proposed new designation shall be applied fourteen (14) days after notice of the dispute unless within that fourteen day period the producer files a motion with the Court to maintain the producer's designation. The producer bears the burden of proving that the information is properly designated as Confidential or Highly Confidential. The information shall remain subject to the producer's Confidential or Highly Confidential designation until the Court rules on the dispute. A party's failure to contest a designation of information as Confidential or Highly Confidential is not an admission that the information was properly designated as such.

4. Use and disclosure of Confidential [or Highly Confidential] information:

a. Confidential and Highly Confidential information may be used exclusively for purposes of this litigation, subject to the restrictions of this order.

b. Absent written permission from the producer or further order by the Court, the recipient may not disclose Confidential information to any person other than the following: (i) a party's outside counsel of record, including necessary paralegal, sec-

retarial and clerical personnel assisting such counsel; (ii) a party's in-house counsel; (iii) a party's officers and employees directly involved in this case whose access to the information is reasonably required to supervise, manage, or participate in this case; (iv) a stenographer and videographer recording testimony concerning the information; (v) subject to the provisions of paragraph 4(d) of this order, experts and consultants and their staff whom a party employs for purposes of this litigation only; and (vi) the Court and personnel assisting the Court.

c. Absent written permission from the producer or further order by the Court, the recipient may not disclose Highly Confidential information to any person other than those identified in paragraph 4(b)(i), (iv), (v), and (vi).

d. A party may not disclose Confidential or Highly Confidential information to an expert or consultant pursuant to paragraph 4(b) or 4(c) of this order until after the expert or consultant has signed an undertaking in the form of Appendix 1 to this Order. The party obtaining the undertaking must serve it on all other parties within ten days after its execution. At least ten days before the first disclosure of Confidential or Highly Confidential information to an expert or consultant (or member of their staff), the party proposing to make the disclosure must serve the producer with a written identification of the expert or consultant and a copy of his or her curriculum vitae. If the producer has good cause to object to the disclosure (which does not include challenging the qualifications of the expert or consultant), it must serve the party proposing to make the disclosure with a written objection within ten days after service of the identification. Unless the parties resolve the dispute within ten days after service of the objection, the producer must move the Court promptly for a ruling, and the Confidential or Highly Confidential information may not be disclosed to the expert or consultant without the Court's approval.

e. Notwithstanding paragraph 4(a) and (b), a party may disclose Confidential or Highly Confidential information to: (i) any employee or author of the producer; (ii) any person, no longer affiliated with the producer, who authored the information in whole or in part; and (iii) any person who received the information before this case was filed.

f. A party who wishes to disclose Confidential or Highly Confidential information to a person not authorized under paragraph 4(b) or 4(c) must first make a reasonable attempt to obtain the producer's permission. If the party is unable to obtain permission, it may move the Court to obtain permission.

5. Copies: A party producing documents as part of discovery must, upon request, furnish the requesting party with one copy of the documents it requests, at the requesting party's expense. Before copying, the parties must agree upon the rate at which the requesting party will be charged for copying.

6. Inadvertent Disclosure: Inadvertent disclosures of material protected by the attorney-client privilege or the work product doctrine shall be handled in accordance with Federal Rule of Evidence 502.

7. Filing with the Court:

a. This protective order does not, by itself, authorize the filing of any document under seal. No document may be filed under seal without prior leave of court. A party wishing to file under seal a document containing Confidential or Highly Con-

fidential information must move the Court, consistent with Local Rule 26.2(b) and prior to the due date for the document, for permission to file the document under seal. If a party obtains permission to file a document under seal, it must also (unless excused by the Court) file a public-record version that excludes any Confidential or Highly Confidential information.

b. If a party wishes to file in the public record a document that another producer has designated as Confidential or Highly Confidential, the party must advise the producer of the document no later than five business days before the document is due to be filed, so that the producer may move the Court to require the document to be filed under seal.

c. Pursuant to Local Rule 5.8, any document filed under seal must be accompanied by a cover sheet disclosing (i) the caption of the case, including the case number; (ii) the title “Restricted Document Pursuant to Local Rule 26.2;” (iii) a statement that the document is filed as restricted in accordance with a court order and the date of the order; and (iv) the signature of the attorney of record filing the document.

8. Document Disposal: Upon the conclusion of this case, each party must return to the producer all documents and copies of documents containing the producer’s Confidential [or Highly Confidential] information, and must destroy all notes, memoranda, or other materials derived from or in any way revealing confidential or highly confidential information. Alternatively, if the producer agrees, the party may destroy all documents and copies of documents containing the producer’s Confidential or Highly Confidential information. The party returning and/or destroying the producer’s Confidential and Highly Confidential information must promptly certify in writing its compliance with the requirements of this paragraph. Notwithstanding the requirements of this paragraph, a party and its counsel may retain one complete set of all documents filed with the Court, remaining subject to all requirements of this order.

9. Originals: A legible photocopy of a document may be used as the “original” for all purposes in this action. The actual “original,” in whatever form the producing party has it, must be made available to any other party within ten days after a written request.

10. Survival of obligations: This order’s obligations regarding Confidential and Highly Confidential information survive the conclusion of this case.

Appendix 1

IN THE UNITED STATES DISTRICT COURT FOR THE NORTHERN DISTRICT OF ILLINOIS EASTERN DIVISION

_____)	
Plaintiff[s],)	
)	
vs.)	Case No. _____
)	
_____)	
Defendant[s].)	

UNDERTAKING OF [insert name]

I, [insert person's name], state the following under penalties of perjury as provided by law:

I have been retained by [insert party's name] as an expert or consultant in connection with this case. I will be receiving Confidential [and Highly Confidential] information that is covered by the Court's protective order dated [fill in date]. I have read the Court's protective order and understand that the Confidential [and Highly Confidential] information is provided pursuant to the terms and conditions in that order.

I agree to be bound by the Court's protective order. I agree to use the Confidential [and Highly Confidential] information solely for purposes of this case. I understand that neither the Confidential [and Highly Confidential] information nor any notes concerning that information may be disclosed to anyone that is not bound by the Court's protective order. I agree to return the Confidential [and Highly Confidential] information and any notes concerning that information to the attorney for [insert name of retaining party] or to destroy the information and any notes at that attorney's request.

I submit to the jurisdiction of the Court that issued the protective order for purposes of enforcing that order. I give up any objections I might have to that Court's jurisdiction over me or to the propriety of venue in that Court.

[signature] Subscribed and sworn to _____

before me this _____ day of _____ 20__.

Notary Public

Appendix 2.4d Stipulation for Protective Order from the District of Minnesota

**FORM 5 STIPULATION FOR PROTECTIVE ORDER
IN THE UNITED STATES DISTRICT COURT
FOR THE DISTRICT OF MINNESOTA**

)	
[NAME OF PARTY],)	
Plaintiff,)	Case No. _____
)	
v.)	
)	STIPULATION FOR
[NAME OF PARTY],)	PROTECTIVE ORDER
Defendant.)	

Upon stipulation of the parties for an order pursuant to Fed. R. Civ. P. 26(c) that trade secret or other confidential information be disclosed only in designated ways:

1. As used in the Protective Order, these terms have the following meanings:

“Attorneys” means counsel of record;

“Confidential” documents are documents designated pursuant to paragraph 2;

“Confidential - Attorneys’ Eyes Only” documents are the subset of Confidential documents designated pursuant to paragraph 5;

“Documents” are all materials within the scope of Fed. R. Civ. P. 34;

“Written Assurance” means an executed document in the form attached as Exhibit A.

2. By identifying a document “Confidential”, a party may designate any document, including interrogatory responses, other discovery responses, or transcripts, that it in good faith contends to constitute or contain trade secret or other confidential information.

3. All Confidential documents, along with the information contained in the documents, shall be used solely for the purpose of this action, and no person receiving such documents shall, directly or indirectly, transfer, disclose, or communicate in any way the contents of the documents to any person other than those specified in paragraph 4. Prohibited purposes include, but are not limited to, use for competitive purposes or the prosecution of additional intellectual property rights.

4. Access to any Confidential document shall be limited to:

- (a) the Court and its officers;
- (b) Attorneys and their office associates, legal assistants, and stenographic and clerical employees;
- (c) persons shown on the face of the document to have authored or received it;
- (d) court reporters retained to transcribe testimony;

[Optional: (e) these inside counsel: [names];]

[Optional: (f) these employees of the parties: [names];]

(g) outside independent persons (i.e., persons not currently or formerly employed by, consulting with, or otherwise associated with any party) who are retained by a party or its attorneys to furnish technical or expert services, or to provide assistance as mock jurors or focus group members or the like, and/or to give testimony in this action.

5. The parties shall have the right to further designate Confidential documents or portions of documents [optional: in the areas of [identify]] as “Confidential - Attorneys’ Eyes Only”. Disclosure of such information shall be limited to the persons designated in paragraphs 4(a), (b), (c), (d), (e), and (g).

6. Third parties producing documents in the course of this action may also designate documents as “Confidential” or “Confidential - Attorneys’ Eyes Only”, subject to the same protections and constraints as the parties to the action. A copy of the Protective Order shall be served along with any subpoena served in connection with this action. All documents produced by such third parties shall be treated as “Confidential - Attorneys’ Eyes Only” for a period of 14 days from the date of their production, and during that period any party may designate such documents as “Confidential” or “Confidential - Attorneys’ Eyes Only” pursuant to the terms of the Protective Order.

7. Each person appropriately designated pursuant to paragraph 4(g) to receive Confidential information shall execute a “Written Assurance” in the form attached as Exhibit A. Opposing counsel shall be notified at least 14 days prior to disclosure to any such person who is known to be an employee or agent of, or consultant to, any competitor of the party whose designated documents are sought to be disclosed. Such notice shall provide a reasonable description of the outside independent person to whom disclosure is sought sufficient to permit objection to be made. If a party objects in writing to such disclosure within 14 days after receipt of notice, no disclosure shall be made until the party seeking disclosure obtains the prior approval of the Court or the objecting party.

8. All depositions or portions of depositions taken in this action that contain trade secret or other confidential information may be designated “Confidential” or “Confidential - Attorneys’ Eyes Only” and thereby obtain the protections accorded other “Confidential” or “Confidential - Attorneys’ Eyes Only” documents. Confidentiality designations for depositions shall be made either on the record or by written notice to the other party within 14 days of receipt of the transcript. Unless otherwise agreed, depositions shall be treated as “Confidential - Attorneys’ Eyes Only” during the 14-day period following receipt of the transcript. The deposition of any witness (or any portion of such deposition) that encompasses Confidential information shall be taken only in the presence of persons who are qualified to have access to such information.
9. Any party who inadvertently fails to identify documents as “Confidential” or “Confidential - Attorneys’ Eyes Only” shall have 14 days from the discovery of its oversight to correct its failure. Such failure shall be corrected by providing written notice of the error and substituted copies of the inadvertently produced documents. Any party receiving such inadvertently unmarked documents shall make reasonable efforts to retrieve documents distributed to persons not entitled to receive documents with the corrected designation.
10. Any party who inadvertently discloses documents that are privileged or otherwise immune from discovery shall, promptly upon discovery of such inadvertent disclosure, so advise the receiving party and request that the documents be returned. The receiving party shall return such inadvertently produced documents, including all copies, within 14 days of receiving such a written request. The party returning such inadvertently produced documents may thereafter seek re-production of any such documents pursuant to applicable law.
11. If a party files a document containing Confidential information with the Court, it shall do so in compliance with the Electronic Case Filing Procedures for the District of Minnesota. Prior to disclosure at trial or a hearing of materials or information designated “Confidential” or “Confidential - Attorneys’ Eyes Only”, the parties may seek further protections against public disclosure from the Court.
12. Any party may request a change in the designation of any information designated “Confidential” and/or “Confidential - Attorneys’ Eyes Only”. Any such document shall be treated as designated until the change is completed. If the requested change in designation is not agreed to, the party seeking the change may move the Court for appropriate relief, providing notice to any third party whose designation of produced documents as “Confidential” and/or “Confidential - Attorneys’ Eyes Only” in the action may be affected. The party asserting that the material is Confidential shall have the burden of proving that the information in question is within the scope of protection afforded by Fed. R. Civ. P. 26(c).

13. Within 60 days of the termination of this action, including any appeals, each party shall either destroy or return to the opposing party all documents designated by the opposing party as “Confidential”, and all copies of such documents, and shall destroy all extracts and/or data taken from such documents. Each party shall provide a certification as to such return or destruction as within the 60-day period. Attorneys shall be entitled to retain, however, a set of all documents filed with the Court and all correspondence generated in connection with the action.

14. Any party may apply to the Court for a modification of the Protective Order, and nothing in the Protective Order shall be construed to prevent a party from seeking such further provisions enhancing or limiting confidentiality as may be appropriate.

15. No action taken in accordance with the Protective Order shall be construed as a waiver of any claim or defense in the action or of any position as to discoverability or admissibility of evidence.

16. The obligations imposed by the Protective Order shall survive the termination of this action. Within 60 days following the expiration of the last period for appeal from any order issued in connection with this action, the parties shall remove any materials designated “Confidential” from the office of the Clerk of Court. Following that 60-day period, the Clerk of Court shall destroy all “Confidential” materials.

Stipulated to:

Date: _____ By: _____

Date: _____ By: _____

EXHIBIT A

WRITTEN ASSURANCE

_____ declares that:

I reside at _____ in the city of _____,
county _____, state of _____ ;

I am currently employed by _____ located at
_____ and my current job title is _____.

I have read and believe I understand the terms of the Protective Order dated _____, filed in Civil Action No. _____, pending in the United States District Court for the District of Minnesota. I agree to comply with and be bound by the provisions of the Protective Order. I understand that any violation of the Protective Order may subject me to sanctions by the Court.

I shall not divulge any documents, or copies of documents, designated “Confidential” or “Confidential - Attorneys’ Eyes Only” obtained pursuant to such Protective Order, or the contents of such documents, to any person other than those specifically authorized by the Protective Order. I shall not copy or use such documents except for the purposes of this action and pursuant to the terms of the Protective Order.

As soon as practical, but no later than 30 days after final termination of this action, I shall return to the attorney from whom I have received them, any documents in my possession designated “Confidential” or “Confidential - Attorneys’ Eyes Only”, and all copies, excerpts, summaries, notes, digests, abstracts, and indices relating to such documents.

I submit myself to the jurisdiction of the United States District Court for the District of Minnesota for the purpose of enforcing or otherwise providing relief relating to the Protective Order.

I declare under penalty of perjury that the foregoing is true and correct.

Executed on _____
(Date) (Signature)

Appendix 2.4e

Default Standard for Access to Source Code from the District of Delaware

Absent agreement among the parties, the following procedures shall apply to ensure secure access to source code:

1. A single electronic copy of source code or executable code shall be made available for inspection on a stand-alone computer.
2. The stand-alone computer shall be password protected and supplied by the source code provider.
3. The stand-alone computer shall be located with an independent escrow agent, with the costs of such to be shared by the parties. If the parties cannot agree on such an agent, each party shall submit to the court the name and qualifications of their proposed agents for the court to choose.
4. Access to the stand-alone computer shall be permitted, after notice to the provider and an opportunity to object, to two (2) outside counsel representing the requesting party and two (2) experts retained by the requesting party, all of whom have been approved under the protective order in place. No one from the provider shall have further access to the computer during the remainder of discovery.
5. Source code may not be printed or copied without the agreement of the producing party or further order of the court.
6. The source code provider shall provide a manifest of the contents of the stand-alone computer. This manifest, which will be supplied in both printed and electronic form, will list the name, location, and MD5 checksum of every source and executable file escrowed on the computer.
7. The stand-alone computer shall include software utilities which will allow counsel and experts to view, search, and analyze the source code. At a minimum, these utilities must provide the ability to (a) view, search, and line-number any source file, (b) search for a given pattern of text through a number of files, (c) compare two files and display their differences, and (d) compute the MD5 checksum of a file.
8. If the court determines that the issue of missing files needs to be addressed, the source code provider will include on the stand-alone computer the build scripts, compilers, assemblers, and other utilities necessary to rebuild the application from source code, along with instructions for their use.

Appendix 2.5a Mediation Evaluation Form for Attorneys, Northern District of Illinois

U.S. DISTRICT COURT
NORTHERN DISTRICT OF ILLINOIS (WESTERN DIVISION)
MEDIATION EVALUATION FORM

– For Attorneys –

Please promptly fill out this form after the mediation conference and return it to the ADR Administrator via fax at _____. No case identification will be associated with these responses for purposes other than program evaluation.

Name of Mediator: _____

Case Number: _____

Date of Mediation: _____ Type of Case: _____

Outcome: settled partially settled not settled continued for further mediation

Number of mediation sessions held: _____

Number of hours spent in mediation: _____

Are you the defendant's attorney plaintiff's attorney

Number of cases in which you have participated in mediation prior to this one: ____

1. On a scale of 1 – 5 (1 = strongly disagree, 2 = disagree, 3 = neither agree nor disagree, 4 = agree, 5 = strongly agree), please respond to the following:

	SD	D	N	A	SA
a The mediator was well-prepared for the mediation:	1	2	3	4	5
b My client(s) and I understood the mediation process after it was explained:	1	2	3	4	5
c The mediator helped the parties to generate options:	1	2	3	4	5
d The mediator effectively moved the parties toward settlement:	1	2	3	4	5
e The mediator was knowledgeable about the law in this case:	1	2	3	4	5
f The mediation helped narrow or clarify the issues involved in this case	1	2	3	4	5
g Overall, I am satisfied with the mediation process:	1	2	3	4	5
h The process was fair to all parties:	1	2	3	4	5
i Overall, I am satisfied with what was accomplished in the mediation:	1	2	3	4	5
j Overall, I am satisfied with the agreement (if reached):	1	2	3	4	5

2. Overall, how helpful or detrimental was the mediation in the resolution of this case?

- 1. Very helpful
- 2. Somewhat helpful
- 3. It had little impact on the case
- 4. Somewhat detrimental
- 5. Very detrimental

3. The overall length of mediation was: too long too short about right

4. Did the mediator appear to have a bias for the Plaintiff? Defendant? No Bias

5. Do you think the assignment of this case to mediation:

- Facilitated (or will facilitate) its early resolution
- Will increase time to resolution
- Will have no impact on time to resolution

6. Do you think the assignment of this case to mediation:

- Has reduced (or will reduce) litigation costs to your client
- Will increase litigation costs to your client
- Will have no effect on costs to your client

7. If the case did not settle, why not?

8. Would you be willing to use mediation again? Yes No

Why or why not?

9. Would you be willing to use this mediator again? Yes No

Why or why not?

10. Comments on the mediator or the mediation process:

Appendix 2.5b Mediation Evaluation Form for Mediators, Northern District of Illinois

**U.S. DISTRICT COURT
NORTHERN DISTRICT OF ILLINOIS (WESTERN DIVISION)
MEDIATION EVALUATION FORM**

- For Mediators -

Please fill out this form and return it to the ADR Administrator via fax at _____ within 10 days of the mediation session. No case identification will be associated with these responses for purposes other than program evaluation.

Name: _____

Case Number: _____

Date of Mediation: _____ Type of Case: _____

Outcome: settled partially settled not settled continued for further mediation

Number of cases for which you have acted as mediator prior to this one: _____

1. On a scale of 1 - 5 (1 = strongly disagree, 2 = disagree, 3 = neither agree nor disagree, 4 = agree, 5 = strongly agree), please respond to the following:

	SD	D	N	A	SA
a This case was appropriate for mediation:	1	2	3	4	5
b This case was referred to mediation at the appropriate time:	1	2	3	4	5
c The lawyers were prepared for the mediation:	1	2	3	4	5
d The litigants were prepared for the mediation:	1	2	3	4	5
e The litigants were actively involved in the mediation:	1	2	3	4	5
f The mediation helped narrow or clarify the issues involved in this case:	1	2	3	4	5
g I have expertise in this type of dispute:	1	2	3	4	5
h Overall, I am satisfied with what was accomplished in the mediation:	1	2	3	4	5

2. Overall, how helpful or detrimental was the mediation in the resolution of this case?

- 1. Very helpful
- 2. Somewhat helpful
- 3. It had little impact on the case
- 4. Somewhat detrimental
- 5. Very detrimental

3. The overall length of mediation was: too long too short about right

4. Do you think the assignment of this case to mediation:

- Helped the case resolve more quickly
- Will increase the time it takes to resolve the case
- Will have no effect on the time it takes to resolve the case

5. Do you think the assignment of this case to mediation:

- Has *reduced* (or will reduce) litigation costs to the parties
- Will *increase* litigation costs to the parties
- Will have *no effect* on costs to the parties

6. If the case did not settle, why not?

7. Please check the actions you undertook in the mediation:

- | | |
|--|--|
| <input type="checkbox"/> Focused on legally relevant issues | <input type="checkbox"/> Gave primacy to parties' needs & interests |
| <input type="checkbox"/> Focused on the evidence of the case | <input type="checkbox"/> Focused on parties' perception of case |
| <input type="checkbox"/> Gave an advisory opinion of the likely outcome | <input type="checkbox"/> Helped parties determine strengths & weaknesses of case |
| <input type="checkbox"/> Provided parties with particular settlement options | <input type="checkbox"/> Helped parties generate own proposal or range |

8. Comments on the program:

Appendix 2.5c Mediation Evaluation Form for Parties, Northern District of Illinois

**U.S. DISTRICT COURT
NORTHERN DISTRICT OF ILLINOIS (WESTERN DIVISION)
MEDIATION EVALUATION FORM**

– For Parties –

Please promptly fill out this form after the mediation conference and return it to the ADR Administrator via fax at _____. No case identification will be associated with these responses for purposes other than program evaluation.

Name of Mediator: _____

Case Number: _____

Date of Mediation: _____ Type of Case: _____

Outcome: settled partially settled not settled continued for further mediation

Number of mediation sessions held: ____ Number of hours spent in mediation: ____

Are you the defendant plaintiff

Number of cases in which you have participated in mediation prior to this one: ____

1. On a scale of 1 – 5 (1 = strongly disagree, 2 = disagree, 3 = neither agree nor disagree, 4 = agree, 5 = strongly agree), please respond to the following:

	SD	D	N	A	SA
a The mediator was well-prepared for the mediation:	1	2	3	4	5
b I understood the mediation process:	1	2	3	4	5
c The mediator allowed me to fully present my case:	1	2	3	4	5
d The mediator carefully listened to my side of the case:	1	2	3	4	5
e The mediator helped me to generate options for settling the dispute:	1	2	3	4	5
f The mediation asked appropriate questions to determine the facts of the case:	1	2	3	4	5
g Overall, I am satisfied with the mediation process:	1	2	3	4	5
h The process was fair to all parties:	1	2	3	4	5
i Overall, I am satisfied with what was accomplished in the mediation:	1	2	3	4	5
j Overall, I am satisfied with the agreement (if reached):	1	2	3	4	5

2. Overall, how helpful or detrimental was the mediation in the resolution of this case?

1. Very detrimental;
2. Somewhat detrimental;
3. It had little impact on the case;
4. Somewhat helpful;
5. Very helpful

3. The overall length of mediation was: too long too short about right

4. Did the mediator appear to have a bias for the Plaintiff? Defendant? No Bias

5. Do you think the assignment of this case to mediation:

Facilitated (or will facilitate) its early resolution

Will increase time to resolution

Will have no impact on time to resolution

6. Do you think the assignment of this case to mediation:

Has reduced (or will reduce) litigation costs

Will increase litigation costs

Will have no effect on costs

7. If the case did not settle, why not?

8. Would you be willing to use mediation again? Yes No

Why or why not?

9. Would you be willing to use this mediator again? Yes No

Why or why not?

10. Comments on the mediator or the mediation process:

Chapter 3

Preliminary Injunction

3.1	Introduction	2
3.1.1	The Special Circumstances of the Preliminary Injunction Application in Patent Cases	4
3.1.2	Opportunities Presented by Preliminary Injunction Applications in Patent Cases	4
3.1.3	Frequency of Preliminary Injunction Applications in Patent Cases	5
3.1.4	Governing Legal Standards: § 283, Federal Circuit Law, and Federal Rule of Civil Procedure	65 7
3.1.5	Tension Between Right to Exclude and Equitable Considerations	8
3.1.6	Meaning of Status Quo	8
3.2	Standards and Burdens	9
3.2.1	Discretion of Trial Court	9
3.2.2	Factors to Be Considered	9
3.2.2.1	Reasonable Likelihood of Success on the Merits	10
3.2.2.1.1	Claim Construction and Infringement	10
3.2.2.1.2	Invalidity	10
3.2.2.2	Irreparable Harm if the Preliminary Injunction Is Not Granted	11
3.2.2.2.1	Presumption	11
3.2.2.2.2	Evidentiary Factors	11
3.2.2.2.3	Nonpracticing Entities	13
3.2.2.2.4	Nexus Requirement	14
3.2.2.3	Balance of Hardships	14
3.2.2.4	Impact on the Public Interest	15
3.2.2.5	Burdens of Proof and Persuasion	16
3.2.2.6	Effect of PTAB Review Proceedings	17
3.2.2.6.1	Grant of Ex Parte Reexamination	17
3.2.2.6.2	Institution of Inter Partes Review, Covered Business-Method Review, or Postgrant Review	18
3.2.2.6.3	PTAB Cancellation of Rejection of Claims	18
3.3	Temporary/Ex Parte Orders	19
3.3.1	Generally	19
3.3.2	Procedure	20
3.4	Discovery	21
3.5	Hearing	23
3.5.1	Whether to Conduct a Hearing	23
3.5.2	Notice and Scheduling	23
3.5.3	Evidentiary Showing—What to Expect	24
3.6	Rule 65 Trial	24
3.7	Bond	25
3.8	Order	26
3.8.1	Specificity	26
3.8.2	Parties Affected	28
3.8.3	Modification	28
3.9	Appellate Review	29
3.9.1	Writ Review	29
3.9.2	Stays	30
3.10	Enforcement	31
Appendix 3.1	Template for Order Granting a Preliminary Injunction	33

3.1 Introduction

The patent right—the right to exclude others from practicing the patented technology—has historically been protected by injunctive relief. Courts traditionally viewed patent rights like other property interests and routinely protected them through a “property” rule—barring transgressors from using the “property.” See Guido Calabresi & A. Douglas Melamed, *Property Rules, Liability Rules, and Inalienability: One View of the Cathedral*, 85 Harv. L. Rev. 1089 (1972); cf. § 261 (declaring “patents shall have the attributes of personal property”); *Festo Corp. v. Shoketsu Kinzoku Kogyo Kabishiki Co.*, 535 U.S. 722, 720, 739 (2002) (a patent “is a property right”; patent rights constitute “the legitimate expectations of inventors in their property”); *Fla. Prepaid Postsecondary Educ. Expense Bd. v. Coll. Savings Bank*, 527 U.S. 627, 642 (1999) (“Patents . . . have long been considered a species of property.”).

The principle that injunctive remedies should protect property interests traces to Blackstone’s classic, although exaggerated, definition of property as “that sole and despotic dominion which one man claims and exercises over the external things of the world, in total exclusion of the right of any other individual in the universe”; “postpon[ing] even public necessity to the sacred and inviolable rights of private property.” 2 William Blackstone, *Commentaries on the Laws of England* 2 (1775). From this idea, courts have traditionally presumed that compensation cannot rectify property-based harms. Moreover, in the traditional trespass scenario, ejecting the transgressor and preventing future transgressions will often make good sense, although even there the rigidity of the classic “property rule” has been loosened. See, e.g., *Raab v. Casper*, 51 Cal. App. 3d 866 (1975) (discussing the California Civil Code provision affording jurists equitable discretion in encroachment cases).

For much of the patent system’s history, extrapolating relatively absolute property remedial rules to the protection of patented inventions functioned reasonably well. Although the harm from patent infringement might not always have been irreparable, barring future infringement was relatively easy to administer and did not obviously stand in the way of progress. Thus, in nearly every patent case up until 2006, a victorious patent owner could count on and obtain a permanent injunction. By contrast, preliminary injunctions required a balancing analysis because validity, infringement, and enforceability had not yet been conclusively established. Thus, the choice to pursue preliminary injunctive relief turned on assessing the costs and benefits of seeking expedited review of the case, and the attendant higher burden.

The rise of software and business method patents, as well as the emergence of nonpracticing, patent monetization entities, have strained the traditional view of patents as property interests that deserve near-automatic injunctive relief. See Peter S. Menell, *Governance of Intellectual Resources and Disintegration of Intellectual Property in the Digital Age*, 26 Berkeley Tech. L.J. 1523 (2011). Moreover, markets for many high-technology products could be severely disrupted by the potential for mandatory injunctions for patented components of a complex product.

Several of these issues came to the fore in litigation over a patent claiming the “buy it now” feature of an online purchasing system. See *eBay, Inc. v. MercExchange, LLC*, 547 U.S. 388 (2006). In rejecting the Federal Circuit’s presumption that permanent injunctions should issue after findings of infringement in the absence of “ex-

traordinary circumstances,” the Supreme Court held that the traditional four-factor balancing test that courts of equity employed should apply with equal force in patent cases. *Id.* at 391–94; *but see* Mark P. Gergen, John M. Golden & Henry E. Smith, *The Supreme Court’s Accidental Revolution? The Test for Permanent Injunctions*, 112 Colum. L. Rev. 203 (2012) (showing that the Supreme Court’s *eBay* decision abrogated long-standing remedial standards for permanent injunctions). In so declaring, the Supreme Court opened a new chapter in patent remedies. District courts now enjoy substantial discretion in considering and crafting injunctive relief.

Whereas courts awarded permanent injunctions in nearly all patent cases in which the patent owner prevailed prior to 2006, the grant rate has dropped to 70–75% since the *eBay* decision. *See* Christopher B. Seaman, *Property Rules vs. Liability Rules in Patent Litigation after eBay: An Empirical Study*, 101 Iowa L. Rev. (forthcoming 2016). Permanent injunctions are still relatively routine in life sciences patent cases. They are far less common in the software field, where courts have granted approximately 50% of permanent injunction requests. Operating companies obtain permanent injunctions in about 80% of the cases in which they win, whereas non-practicing entities have obtained permanent injunctions in only 16% of their victories since *eBay*. Similarly, competitors obtain permanent injunctions against rivals in 82% of cases in which they prevail, whereas noncompetitors obtain injunctive relief in just over 20% of the cases where they win.

The equitable framework articulated for awarding permanent injunctions in the *eBay* case derives from traditional standards for *preliminary* injunctions. *See* Gergen, Golden & Smith, 112 Colum. L. Rev. at 208; David I. Levine, David J. Jung & Tracy A. Thomas, *Remedies: Public and Private* 100 (5th ed. 2009). Not surprisingly, courts look to the *eBay* framework in analyzing preliminary injunction motions. *See* Kirti Gupta & Jay P. Kesan, *Studying the Impact of eBay on Injunctive Relief in Patent Cases* (draft July 10, 2015) (finding that that the *eBay* decision has dramatically reduced both the level at which injunctive relief is sought in patent cases and the rate at which it is granted, particularly for preliminary injunctions).

As reflected in Figure 3.1, the total number of preliminary injunction motions on a nationwide basis has been falling since the turn of the millennium. The grant rate has also declined since 2003.

Figure 3.1
Preliminary Injunctions in Patent Cases

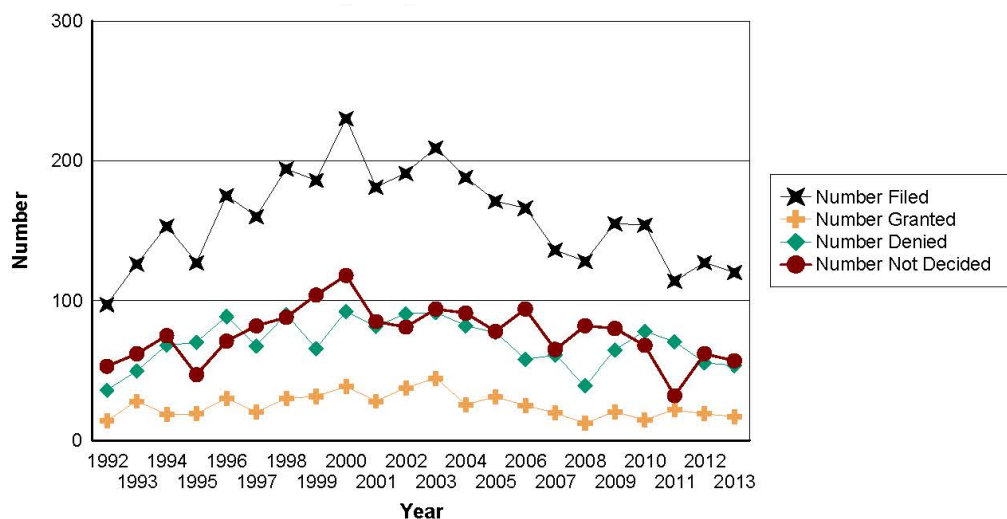

Source: LegalMetric (2015)

3.1.1 The Special Circumstances of the Preliminary Injunction Application in Patent Cases

Preliminary injunction applications in patent matters present special challenges. As in other cases, a party seeking a preliminary injunction in a patent case must demonstrate a likelihood of success on the merits and ongoing irreparable harm. Unlike in other types of cases, this showing in a patent case typically calls for analysis of nearly every substantive issue that ultimately will be presented at trial. To address the merits, the court must at least preliminarily construe patent claim terms. Invalidity, infringement, and enforceability must be addressed based on those constructions. To address harm, the parties often present complicated market analyses. These issues typically require both fact and expert discovery, undertaken on a compressed preliminary injunction schedule. Preliminary injunction applications can, therefore, place a tremendous strain on the court and the parties.

3.1.2 Opportunities Presented by Preliminary Injunction Applications in Patent Cases

While there is no question that a preliminary injunction application places a weighty burden on a court's limited resources, it also presents opportunities for prioritizing case management. Aggressive use of expedited discovery strategies enhances these opportunities. See § 3.4. Effectively managing the parties' expedited discovery demands can put the court in a good position to promote early settlement, summary judgment, and possibly a consolidated trial under Rule 65(a)(2).

Settlement. Because they have identified key claim terms and developed their best arguments for infringement and invalidity, the parties will exit the preliminary injunction process with a better understanding of the relative strengths of their cases. The court will be familiar with the technology and will have heard at least some of the fundamental arguments and counterarguments in the case. This is a propitious time to consider settlement. See § 2.7 (concerning settlement generally). The court may ask the parties to engage in settlement talks and/or mediation either immediately before or immediately after it rules on the preliminary injunction motion.

Early summary judgment or Federal Rule of Civil Procedure 65(a)(2) trial. The preliminary injunction process may reveal one or more case-dispositive issues. For example, the plaintiff may present a clear-cut case of infringement or the defendant may raise a particularly strong invalidity argument. If it appears from a party's submission that there exists a clear, potentially case-dispositive issue, the court can use the preliminary injunction process to expedite discovery on the issue and order an early summary judgment motion or expedited trial on the merits under Federal Rule of Civil Procedure 65(a)(2). See generally § 3.6.

3.1.3 Frequency of Preliminary Injunction Applications in Patent Cases

The frequency with which patentees have sought preliminary injunctions has ebbed and flowed with changes in legal standards and economic conditions over the years. Before the creation of the Federal Circuit in 1982, preliminary injunctions were rarely granted because courts typically required a prior judicial determination of patent validity, and considered damages after trial adequate to compensate for infringement. This made the irreparable-harm prong particularly difficult to establish.

Shortly after its establishment, the Federal Circuit ushered in a new era, emphasizing that “the very nature of the patent right is the right to exclude others. . . . A court should not be reluctant to use its equity powers once a party has so clearly established his patent rights.” *Smith Int'l v. Hughes Tool Co.*, 718 F.2d 1573, 1581 (Fed. Cir. 1983). The court ruled that “where validity and continuing infringement have been clearly established . . . immediate irreparable harm is presumed.” *Id.* (footnote omitted). Over time, however, the Federal Circuit raised the bar for plaintiffs, giving greater weight to the classical view of a preliminary injunction as “a drastic and extraordinary remedy that is not to be routinely granted.” *Intel Corp. v. ULSI Sys. Tech., Inc.*, 995 F.2d 1566, 1568 (Fed. Cir. 1993); see also *Amazon.com, Inc. v. Barnesandnoble.com, Inc.*, 239 F.3d 1343, 1366 (Fed. Cir. 2001) (overturning grant of a preliminary injunction where the defendant “raised substantial questions” as to the patent's validity). In 2006, the Supreme Court reinforced this more searching and cautious perspective when it held that courts in patent cases must weigh all of the factors in any injunction analysis—likelihood of success on the merits, irreparable harm, balance of hardships, and public interest. *eBay*, 547 U.S. at 391–92. As reflected in Figure 3.1, the *eBay* decision likely has perpetuated the downward trend in preliminary injunction motions that began in 2000.

Nevertheless, preliminary injunctions remain an important option in some patent cases, particularly those involving dynamic, fast-paced, highly competitive markets where plaintiffs believe they will lose the benefit of their patent rights absent a preliminary injunction. Furthermore, the Federal Circuit's en banc *In re Seagate Tech., LLC*, 497 F.3d 1360 (Fed. Cir. 2007), decision may encourage preliminary injunction applications where the alleged infringement begins on or about the date that the plaintiff filed the infringement suit.¹ In *Seagate*, the Federal Circuit explained that “[a] patentee who does not attempt to stop an accused infringer’s activities [by seeking a preliminary injunction] should not be allowed to accrue enhanced damages based solely on the infringer’s post-filing conduct.” *Id.* at 1374. It is unclear how this portion of *Seagate*’s analysis will apply in light of the Supreme Court’s decision in *Halo Electronics, Inc., v. Pulse Electronics, Inc.*, Nos. 14-1513 and 14-1520 (June 3, 2016) (*see* § 9.2.2), but because *Halo* continues to consider willfulness an important factor in an enhanced damages determination, that a plaintiff did not seek a preliminary injunction likely will continue to be an important consideration in some cases.

Under the *Seagate* test, in most cases in which a plaintiff seeks only prospective damages (i.e., where both the conduct giving rise to alleged damages and the conduct giving rise to the alleged willfulness occurred after the complaint was filed), the plaintiff must seek a preliminary injunction to have a reasonable chance of recovering enhanced damages for willful infringement. Where the conduct allegedly giving rise to willfulness includes pre-filing conduct, however, *Seagate* does not suggest the plaintiff should move for a preliminary injunction as a predicate to obtaining enhanced damages. The Federal Circuit in *Seagate* explained that “if a patentee attempts to secure injunctive relief but fails, it is likely the infringement did not rise to the level of recklessness [that is necessary for a willfulness finding].” *Id.* The court reasoned that “[a] substantial question about invalidity or infringement is likely sufficient not only to avoid a preliminary injunction, but also a charge of willfulness based on post-filing conduct.” *Id.* Thus, a party that seeks but fails to win a preliminary injunction for reasons relating to the patent’s validity or infringement may have done significant harm to its case for enhanced postfiling damages.

There is one notable exception: “in some cases a patentee may be denied a preliminary injunction despite establishing a likelihood of success on the merits, such as when the remaining factors are considered and balanced. In that event, whether a willfulness claim based on conduct occurring solely after litigation began is sustainable will depend on the facts of each case.” *Id.* at 1374; *see also Aqua Shield v. Inter Pool Cover Team*, 774 F.3d 766, 773–75 (Fed. Cir. 2014) (denial of preliminary injunction for reasons other than validity or infringement does not preclude finding of willfulness).

1. Patent litigation is often filed shortly after a patent issues or a new product is introduced. In such cases, damages typically are based solely on postfiling conduct.

3.1.4 Governing Legal Standards: § 283, Federal Circuit Law, and Federal Rule of Civil Procedure 65

District courts have discretion to grant injunctions to prevent the violation of patent rights. Section 283 provides that courts “may grant injunctions in accordance with the principles of equity to prevent the violation of any right secured by patent, on such terms as the court deems reasonable.” To evaluate a preliminary injunction application, the court uses the traditional four-factor test: the court weighs the applicant’s likelihood of success on the merits, irreparable harm to the applicant, the balance of harm between the parties, and the public interest. *See eBay*, 547 U.S. at 391–92. This standard is essentially the same as that for a permanent injunction (*see* § 9.2.1), except that the applicant must prove a likelihood of success on the merits rather than actual success. *Apple Inc. v. Samsung Elecs. Co. (Apple III)*, 735 F.3d 1352, 1381 (Fed. Cir. 2013) (a permanent injunction case). Courts therefore often look to permanent injunction cases for guidance in evaluating the relevant factors.

Federal Rule of Civil Procedure 65 sets forth the procedures governing preliminary injunction motions. Federal Circuit law governs the analysis. While “the grant of a preliminary injunction [is] a matter of procedural law not unique to the exclusive jurisdiction of the Federal Circuit, and on appellate review . . . procedural law of the regional circuit in which the case was brought [applies],” Federal Circuit law governs the decision as to whether to grant a preliminary injunction. *Mikohn Gaming Corp. v. Acres Gaming, Inc.*, 165 F.3d 891, 894 (Fed. Cir. 1998). “Because the issuance of an injunction . . . enjoins ‘the violation of any right secured by a patent, on such terms as the court deems reasonable,’ a preliminary injunction . . . , although a procedural matter, involves substantive matters unique to patent law and, therefore, is governed by the law of [the Federal Circuit].” *Revision Military, Inc. v. Balboa Mfg. Co.*, 700 F.3d 524, 525 (Fed. Cir. 2012) (quoting *Hybritech Inc. v. Abbott Labs.*, 849 F.2d 1446, 1451 n.12 (Fed. Cir. 1988)).

While the district court can grant or deny the injunction at its discretion, the grant or denial must be supported by findings of fact that explicitly address the equitable factors weighed in the decision process. *See* Fed. R. Civ. P. 52(a); *Pretty Punch Shoppettes, Inc. v. Hawk*, 844 F.2d 782, 784 (Fed. Cir. 1988). The trial court must provide sufficient factual findings to enable meaningful review of the merits of its order. *Nutrition 21 v. United States*, 930 F.2d 867, 869 (Fed. Cir. 1991) (“Sufficient factual findings on the material issues are necessary to allow [the Federal Circuit] to have a basis for meaningful review. Otherwise, [the Federal Circuit] has no basis for evaluating what facts entered into the district court’s analysis or whether the district court’s reasoning comports with the applicable legal standard.”) (citations omitted); *Oakley, Inc. v. Int’l Tropic-Cal, Inc.*, 923 F.2d 167, 168 (Fed. Cir. 1991) (vacating preliminary injunction where “the court’s findings . . . [were] so limited and conclusory that meaningful appellate review [was] not possible”).

“[A] district court must consider all four factors before *granting* a preliminary injunction to determine whether the moving party has carried its burden of establishing each of the four.” *Reebok Int’l Ltd. v. J. Baker, Inc.*, 32 F.3d 1552, 1556 (Fed. Cir. 1994). This requirement does not, however, extend to the denial of a prelimi-

nary injunction, which may be based on a party's failure to make a showing on any one of the four factors, particularly, the first two—likelihood of success on the merits and irreparable harm. *See, e.g., Guttman, Inc. v. Kopykake Enters.*, 302 F.3d 1352, 1356 (Fed. Cir. 2002); *Polymer Techs., Inc. v. Bridwell*, 103 F.3d 970, 973–74 (Fed. Cir. 1996) (“[A] trial court need not make findings concerning the third or fourth factors if the moving party fails to establish either of the first two factors.”).

3.1.5 Tension Between Right to Exclude and Equitable Considerations

Due to the evolution of the legal standards governing preliminary injunction determinations as well as philosophical differences among Federal Circuit jurists, litigants will be able to cite apparently conflicting authority regarding the proper standard. As traced above, *see* § 3.1.3, the Federal Circuit initially emphasized the role of equity to protect the right to exclude, erecting a rebuttable presumption of irreparable harm once validity and continuing infringement were established. *Smith Int'l*, 718 F.2d 1573. Over time, the Federal Circuit has shifted away from that standard, although it still echoes in decisions. *See, e.g., Presidio Components, Inc. v. Am. Tech. Ceramics Corp.*, 702 F.3d 1351, 1363 (Fed. Cir. 2012) (“This analysis proceeds under the ‘long tradition of equity practice’ granting ‘injunctive relief upon a finding of infringement in the vast majority of patent cases’” (quoting *eBay*, 547 U.S. at 395 (Roberts, C.J., concurring))). As these Federal Circuit cases recognize, however, the Supreme Court's decision in *eBay* firmly establishes the need for courts to balance all of the equitable considerations carefully. 547 U.S. at 391–92.

3.1.6 Meaning of Status Quo

As in other cases, “[t]he purpose of a preliminary injunction is to preserve the relative positions of the parties until a trial on the merits can be held.” *Univ. of Tex. v. Camenisch*, 451 U.S. 390, 395 (1981). A preliminary injunction preserves the status quo if it prevents future infringement, but does not undertake to assess the pecuniary or other consequences of past infringement. *Atlas Powder Co. v. Ireco Chems.*, 773 F.2d 1230, 1232 (Fed. Cir. 1985). Thus, an accused infringer cannot avoid a preliminary injunction merely by arguing that, because it is presently practicing the disputed technology, preserving the status quo requires that it be allowed to continue the practice. *Id.* Balancing the harms considers the accused infringer's dependence on allegedly infringing activity. *Id.*; *Circle R, Inc. v. Smithco Mfg.*, 919 F. Supp. 1272, 1303 (N.D. Iowa 1996). However, “the status quo catchword does not necessarily allow [an accused infringer] to continue such dependence, apart from other factors ‘[S]tatus quo’ is not a talisman to dispose of the question by itself.” *Atlas Powder*, 773 F.2d at 1232; *see also Windsurfing Int'l, Inc. v. AMF, Inc.*, 782 F.2d 995, 1003 n.12 (Fed. Cir. 1986) (considering a permanent injunction). *But see Archive Corp. v. Cipher Data Prods., Inc.*, CIV A Nos. SACV88296AHSRWRX, SACV88472AHSRRS, 1988 WL 168533, 1988 U.S. Dist. LEXIS 17190, at *18 (C.D. Cal. Dec. 22, 1988) (“Because [the defendant] has been manufacturing [and selling]

the accused [products] long prior to the issuance of [the asserted] patent, [a preliminary] injunction could not preserve the status quo and would conversely create new market conditions.”)²

3.2 Standards and Burdens

3.2.1 Discretion of Trial Court

The grant or denial of a preliminary injunction is within the sound discretion of the district court. *See Abbott Labs. v. Andrx Pharm., Inc.*, 452 F.3d 1331, 1334 (Fed. Cir. 2006). Abuse of discretion in granting or denying a preliminary injunction requires a “showing that the court made a clear error of judgment in weighing relevant factors or exercised its discretion based upon an error of law or clearly erroneous factual findings.” *Id.* at 1335 (quoting *Polymer Techs.*, 103 F.3d at 973).

Findings of fact are reviewed for clear error. However, “[t]o the extent that a district court’s decision to grant a preliminary injunction hinges on questions of law, [appellate] review is de novo.” *Mylan Pharm., Inc. v. Thompson*, 268 F.3d 1323, 1329 (Fed. Cir. 2001).

3.2.2 Factors to Be Considered

The traditional equitable considerations apply to the analysis of injunctions in patent cases. *eBay*, 547 U.S. 388. Courts must apply Federal Circuit law to assess these considerations. *Mikohn*, 165 F.3d at 894.

The factors—likelihood of success on the merits, irreparable harm, balance of hardship, and public interest—“taken individually, are not dispositive; rather, the district court must weigh and measure each factor against the other factors and against the form and magnitude of the relief requested.” *Hybritech*, 849 F.2d at 1451. However, the factors do not all carry equal weight; the first two factors effectively set up a threshold showing that the patent holder must meet before the other factors are weighed. *See Amazon.com*, 239 F.3d at 1350 (“[A] movant cannot be granted a preliminary injunction unless it establishes *both* of the first two factors, *i.e.*, likelihood of success on the merits and irreparable harm.”).

2. The facts of a given case may temper a court’s response to a defendant’s decision to build a business on an infringing product. Shutting down a defendant’s business through a preliminary injunction likely would require an unusually strong showing on the merits, the absence of which could dictate that a defendant should have the opportunity of a trial, before seeing its business destroyed. *See Ill. Tool Works, Inc. v. Grip-Pak, Inc.*, 906 F.2d 679, 683–84 (Fed. Cir. 1990) (observing that the result in *Windsurfing* did not support a preliminary injunction where the defendant would not be allowed its day in court).

3.2.2.1 Reasonable Likelihood of Success on the Merits

To satisfy the first equitable factor, the moving party must demonstrate that, “in light of the presumptions and burdens that will inhere at trial on the merits, [the movant] will likely prove that [the accused infringer’s] product infringes the [asserted] patent and that it will withstand [the accused infringer’s] challenges to the validity and enforceability of the . . . patent.” *Sanofi-Synthelabo v. Apotex, Inc.*, 470 F.3d 1368, 1374 (Fed. Cir. 2006) (internal citations omitted); *see also Trebro Mfg., Inc. v. Firefly Equip., LLC*, 748 F.3d 1159 (Fed. Cir. 2014); *AstraZeneca LP v. Apotex, Inc.*, 633 F.3d 1042, 1050 (Fed. Cir. 2010); *Amazon.com*, 239 F.3d at 1350 (Fed. Cir. 2001).

3.2.2.1.1 Claim Construction and Infringement

Likelihood of success in proving infringement and defending validity “depends fundamentally on the meaning of the asserted claim and its relationship to the accused product or process. Therefore, a correct claim construction is almost always a prerequisite for imposition of a preliminary injunction.” *Chamberlain Grp., Inc. v. Lear Corp.*, 516 F.3d 1331, 1339–40 (Fed. Cir. 2008). However, claim constructions determined during the preliminary injunction stage are always subject to later revision and do not stand as law of the case for purposes of subsequent proceedings. *See* § 5.3.2.4.1; *Guttman*, 302 F.3d at 1361 (explaining that “district courts may engage in a rolling claim construction” when beginning at the preliminary injunction stage); *Purdue Pharma L.P. v. Boehringer Ingelheim GmbH*, 237 F.3d 1359, 1363 (Fed. Cir. 2001) (“[F]indings of fact and conclusions of law at the preliminary injunction stage are subject to change.”).

3.2.2.1.2 Invalidity

The patentee seeking a preliminary injunction is expected to make a clear showing it is entitled to relief, including the absence of any substantial question as to the validity of the asserted patent claim(s). *Trebro Mfg.*, 748 F.3d at 1166–67. In addition to evidence rebutting any invalidity claim by the defendant, evidence that supports such a showing includes the patent previously withstanding a validity challenge or industry acquiescence to the patent’s validity by licensing. *Id.* Similarly, where a defendant asserts that a patent is unenforceable (e.g., resulting from inequitable conduct), the patentee must show that the defense “lacks substantial merit.” *Purdue Pharma*, 237 F.3d at 1366.

As a practical matter, the opposing party bears the burden of persuasion. The opposing party “must show a substantial question of invalidity to avoid a showing of likelihood of success.” *Erico Int’l Corp. v. Vutec Corp.*, 516 F.3d 1350, 1354 (Fed. Cir. 2008); *see Sciele Pharma Inc. v. Lupin Ltd.*, 684 F.3d 1253, 1359 (Fed. Cir. 2012). Note, however, that “an accused infringer may avoid a preliminary injunction by showing only a *substantial question* as to invalidity, as opposed to the higher clear and convincing standard required to prevail on the merits.” *In re Seagate Tech.*, 497 F.3d at 1374 (emphasis added) (citing *Amazon.com*, 239 F.3d at 1359). Stated another way, “[v]ulnerability is the issue at the preliminary injunction stage, while validity is the issue at trial. The showing of a substantial question as to invalidity thus re-

quires less proof than the clear and convincing showing necessary to establish invalidity itself.” *Amazon.com*, 239 F.3d at 1359.

3.2.2.2 Irreparable Harm if the Preliminary Injunction Is Not Granted

3.2.2.2.1 Presumption

Following the Supreme Court’s decision in *eBay*, the Federal Circuit overturned its prior rule that patent owners who demonstrate a likelihood of success on the merits enjoy a presumption of irreparable injury. *Robert Bosch LLC v. Pylon Mfg. Corp.*, 659 F.3d 1142, 1148–49 (Fed. Cir. 2011). Nevertheless, in evaluating irreparable harm, the court should consider a patent holder’s right to exclude infringers. *Id.*

3.2.2.2.2 Evidentiary Factors

Table 3.1 summarizes how Federal Circuit cases since *eBay* have applied the irreparable harm factor in common fact patterns. For multifeatured products, these factors are applied in light of the nexus requirement described in § 3.2.2.2.4.

**Table 3.1
Post-*eBay* Application of Irreparable Harm**

Facts Supporting Irreparable Harm	Facts Against Irreparable Harm
<ul style="list-style-type: none"> • Infringer is competitor <ul style="list-style-type: none"> ○ Two- or few-player market^{1,8} ○ Potential loss of market share and customers^{1,3,7} ○ Potential loss to patent owner of follow-on purchases¹ ○ Price erosion^{3,5,6} ○ Harm to goodwill, brand recognition^{3,4,6} ○ Harm to reputation³ ○ Workforce reduction resulting from competition^{4,6,7} • That customers are unlikely to switch in the future, and therefore infringement causes long-term loss¹ 	<ul style="list-style-type: none"> • Delay in seeking relief¹ • Availability of calculable award of money damages to patent holder that includes compensation based on future sales of infringing product¹ • Lack of causal nexus between alleged irreparable harm and infringement²
<p>1. <i>Apple, Inc. v. Samsung Elecs. Co. (Apple I)</i>, 678 F.3d 1314 (Fed. Cir. 2012) (including concurrence). 2. <i>Apple, Inc. v. Samsung Elecs. Co. (Apple II)</i>, 695 F.3d 1370 (Fed. Cir. 2012). 3. <i>Aria Diagnostics, Inc. v. Sequenom, Inc.</i>, 726 F.3d 1296 (Fed. Cir. 2013). 4. <i>AstraZeneca LP v. Apotex, Inc.</i>, 633 F.3d 1042 (Fed. Cir. 2010). 5. <i>Celsis In Vitro, Inc. v. CellzDirect, Inc.</i>, 664 F.3d 922, 930 (Fed. Cir. 2012). 6. <i>Sanofi-Synthelabo v. Apotex, Inc.</i>, 470 F.3d 1368 (Fed. Cir. 2006). 7. <i>Trebro Mfg., Inc. v. Firefly Equip., LLC</i>, 748 F.3d 1159 (Fed. Cir. 2014). 8. <i>Robert Bosch LLC v. Pylon Mfg. Corp.</i>, 659 F.3d 1142, 1151 (Fed. Cir. 2011).</p>	

When the parties are direct competitors, irreparable harm is more likely. *Robert Bosch LLC*, 659 F.3d at 1152–54. Even when the usual economic consequences of competition—price and market erosion—likely would be calculable and thus “reparable” through a damages award, this is not a sufficient reason to deny a preliminary injunction. *Aria Diagnostics, Inc. v. Sequenom, Inc.*, 726 F.3d 1296, 1304 (Fed. Cir. 2013) (vacating denial of preliminary injunction); *see also Trebro Mfg.*, 748 F.3d at 1170–71 (Fed. Cir. 2014) (same). In a competitive situation, that the patent holder does not practice its patent also is not necessarily a reason to deny a preliminary injunction. *Trebro Mfg.*, 748 F.3d at 1171.

While the facts may warrant a preliminary injunction, in some instances, it should be narrowly tailored to minimize irreparable harm while still allowing the accused infringer some commercialization. *See, e.g., P.N.A. Constr. Techs. v. McTech Grp., Inc.*, 414 F. Supp. 2d 1228, 1244 (N.D. Ga. 2006) (“[T]he Court believes preliminary injunctive relief tailored to the unique facts here best serves the law and the parties. Specifically, the Court is not inclined to consider granting a comprehensive injunction, especially one that would prohibit Defendants from performing contracts into which it already has entered. The risk to Plaintiff’s patent rights derives, in the Court’s view, from continuing sales, and if a preliminary injunction is entered, it ought to apply only to new contracts.”).

Irreparable harm may be rebutted by showing that the patent holder delayed in bringing its infringement action. *See Apple, Inc. v. Samsung Elecs. Co.*, 678 F.3d 1314, 1325–26 (Fed. Cir. 2012); *Pfizer, Inc. v. Teva Pharms., USA, Inc.*, 429 F.3d 1364, 1381 (Fed. Cir. 2005). *But see High Tech Med. Instr., Inc. v. New Image Indus., Inc.*, 49 F.3d 1551 (Fed. Cir. 1995) (“[T]he period of delay may not have been enough, standing alone, to demonstrate the absence of irreparable harm.”). Likewise, if future infringement is unlikely or the patent holder has licensed the patent to others, irreparable injury may be more difficult to establish. *See Pfizer, Inc.*, 429 F.3d at 1381; *Novo Nordisk A/S v. Sanofi-Aventis U.S. LLC*, Civ. Action No. 07-3206 (MLC), 2008 WL 6098829, 2008 U.S. Dist. LEXIS 12342, 21–22 (D.N.J. Feb. 19, 2008) (*aff’d*, *Novo Nordisk A/S v. Sanofi-Aventis U.S. LLC*, 290 F. App’x 334 (Fed. Cir. July 30, 2008) (unpublished)). In considering a patent holder’s past licensing, however, a court must consider relevant differences between past situations in which licenses were granted and the current alleged infringement. *Apple III*, 735 F.3d at 1370 (Fed. Cir. 2013); *see also eBay*, 547 U.S. at 393.

Irreparable harm, however, is not necessarily rebutted by showing that other competitors also infringe the patent (*Aria Diagnostics*, 726 F.3d at 1305; *Robert Bosch LLC*, 659 F.3d at 1150–52; *Pfizer, Inc.*, 429 F.3d at 1381), the patented product is not “core” to the patent holder’s business (*Robert Bosch LLC*, 659 F.3d at 1150–52), or the alleged infringer can pay any damages award (*Apple III*, 735 F.3d at 1369). Nor is it rebutted by the potential that damages and market recovery *might* ameliorate the harm resulting from price and market erosion (*Aria Diagnostics*, 726 F.3d at 1304) or that damages from market erosion *might* be estimable (*Trebro Mfg.*, 749 F.3d at 1170 (Fed. Cir. 2014)).

3.2.2.2.3 Nonpracticing Entities

Where a patentee does not practice the invention or otherwise commercially exploit it and is not a competitor of the alleged infringer, irreparable harm is more difficult to demonstrate. See *High Tech Med. Instruments*, 49 F.3d at 1556 (“Although a patentee’s failure to practice an invention does not necessarily defeat the patentee’s claim of irreparable harm, the lack of commercial activity by the patentee is a significant factor in the calculus.”). That the patentee neither competes with the alleged infringer nor practices the invention is a factor that concerns trial courts. See, e.g., *Paice LLC v. Toyota Motor Corp.*, 2006 WL 2385139, 2006 U.S. Dist. LEXIS 61600 (E.D. Tex. Aug. 16, 2006), *aff’d in part and vacated*, 504 F.3d 1293, 1303 (Fed. Cir. 2007) (holding that “because Plaintiff does not compete for market share . . . concerns regarding loss of brand name recognition and market share similarly are not implicated”).

Nevertheless, a nonpracticing entity is not barred from obtaining a preliminary injunction:

[S]ome patent holders, such as university researchers or self-made inventors, might reasonably prefer to license their patents, rather than undertake efforts to secure the financing necessary to bring their work to market themselves. Such patent holders may be able to satisfy the traditional four-factor test, and we see no basis for categorically denying them the opportunity to do so.

eBay, 547 U.S. at 392. Relying on this portion of the *eBay* opinion, the district court in *Commonwealth Scientific and Industrial Research Organisation (CSIRO) v. Buffalo Technology Inc.*, 492 F. Supp. 2d 600 (E.D. Tex. 2007), granted a permanent injunction to a nonpracticing entity. CSIRO is the principal scientific research organization of the Australian government, similar to the United States’ National Science Foundation and National Institutes of Health. It “relies heavily on the ability to license its intellectual property to finance its research and development.” *Id.* at 604. The trial court held that, even though CSIRO did not commercialize its patent itself and instead sought licensing revenue, the harm CSIRO suffered was not merely financial: Buffalo’s infringement meant that CSIRO’s “reputation as a research institution has been impugned just as another company’s brand recognition or good will may be damaged.” *Id.* at 605.

In discussions of the subject of nonpracticing entities (and sometimes in briefs), the pejorative term “patent troll” is often used to conjure an image of opportunistic misuse of the patent system. The label is as analytically unhelpful as it is attention-grabbing, which is why it is not generally found in judicial opinions. It is not necessary for a court to determine whether a patent owner is a “troll” to determine where the equities lie. Instead, as *Paice* and *CSIRO* show, the issue is whether the infringement causes irreparable harm to the patentee. Under some circumstances, a nonpracticing patentee may suffer irreparable harm from ongoing infringement, *CSIRO*, 492 F. Supp. 2d at 607–08, but under other circumstances it may not, *Paice*, 504 F.3d at 1303.

3.2.2.2.4 Nexus Requirement

Not all patents encompass all or major portions of a product. When a patent encompasses just one or a small number of features, the patentee must show a causal nexus between irreparable harm resulting from the sale and an infringing feature to prove irreparable harm. *Apple, Inc. v. Samsung Elecs. Co. (Apple II)*, 695 F.3d 1370, 1374–75 (Fed. Cir. 2012); *Apple, Inc. v. Samsung Elecs. Co. (Apple I)*, 678 F.3d 1314, 1324 (Fed. Cir. 2012). This is not a true or false determination that showing any nexus satisfies. Instead, it requires a determination of the extent to which the irreparable harm that results from the sale of the accused product can be ascribed to the infringing feature. *Apple II*, 695 F.3d at 1375. The required showing is usually made by proof that the infringing feature drives consumer demand for the accused product. *Id.* The forces driving consumers' purchase of the product can be proven in various ways, including evidence that the infringing feature is, if not the sole driver of consumer demand, one of several that influence consumer purchases; that inclusion of the infringing feature makes the product significantly more desirable; or that consumers would pay significantly more for a product if it contains the feature. *Id.* at 1364–65, 1367. If most customers buy the infringing product for other reasons, however, the infringement is not deemed to result in irreparable harm. *Id.* at 1375. It is not enough to show only that removal of the infringing feature would render the product inoperative or worthless, because such a test could be satisfied by many features that are necessary for a product to operate properly, but nevertheless have little or no impact on a consumer's buying decision. *Id.* at 1376. In situations where multiple product features infringe the patentee's patents, it is their cumulative impact on consumer buying decisions that should be considered. *Apple III*, 735 F.3d at 1364.

3.2.2.3 Balance of Hardships

The grant of a preliminary injunction in a patent case often results in the defendant having to remove a product from the market, or at least drastically modify it, pending trial. Furthermore, given the extended duration of many patent cases, the defendant may face months or even years before the product can be reintroduced (assuming the defendant prevails). As a result, the hardship on the defendant can be drastic. That is why the patentee must post a bond to get a TRO or preliminary injunction. *See* § 3.7. On the other hand, a patent holder enjoys a right that can only be exploited for a limited time. Denial of that right for the months or years of a patent case can lead to hardship in the form of price erosion, loss of reputation, loss of market share, and lost opportunity to lead or even dominate a market the patent holder ought rightfully to lead (assuming the patent holder prevails). In *Illinois Tool Works*, the Federal Circuit considered these opposing hardships and explained:

The hardship on a preliminarily enjoined manufacturer who must withdraw its product from the market before trial can be devastating. On the other hand, the hardship on a patentee denied an injunction after showing a strong likelihood of success on validity and infringement consists in a frequently and equally serious delay in the exercise of his limited-in-time property right to exclude. Neither hardship can be controlling in all cases. Because the court must balance the hardships, at least

in part in light of its estimate of what is likely to happen at trial, it must consider the movant's showing of likelihood of success. Yet, a court must remain free to deny a preliminary injunction, whatever be the showing of likelihood of success, when equity in the light of all the factors so requires.

Ill. Tool Works, Inc. v. Grip-Pak, Inc., 906 F.2d 679, 683 (Fed. Cir. 1990). Courts facing the prospect of such dire consequences to one party or the other, therefore, must engage in a sensitive analysis of the unique facts of each case.

A party's considered business decision to take a calculated risk of infringement cannot, however, alone form the basis of a finding of harm to justify denying injunctive relief. See *Aria Diagnostics*, 726 F.3d at 1305 (harm to infringer must be balanced against harm to patentee's "R&D and investment in the technology, undermining work and money spent developing, validating, and commercializing any covered product"); *Sanofi-Synthelabo, Inc.*, 470 F.3d at 1383 ("The court did not clearly err in finding that Apotex's harms were 'almost entirely preventable' and were the result of its own calculated risk to launch its product pre-judgment."). Thus, for example, a party that elected to launch an accused product during patent litigation could not avoid a preliminary injunction by complaining that the harm incurred in having to cease manufacture and sale of the product outweighed the patent holder's harm in facing irreversible price erosion. *Sanofi-Synthelabo*, 470 F.3d at 1382–83.

3.2.2.4 Impact on the Public Interest

Although the public has an abstract interest in protecting rights secured by valid patents, the focus of the district court's public-interest analysis should be whether the public has some critical interest in the specific case that would be injured by the grant or denial of preliminary relief. See *Hybritech*, 849 F.2d 1446, 1458 (Fed. Cir. 1988). Thus, the public interest in enforcement of valid patents, taken alone, does not skew this factor toward the patent holder. See *id.* However, a specific public concern can weigh heavily in the analysis, particularly in an industry, such as pharmaceuticals, where development costs can be especially high and the public interest in effective new products is also high. See *Sanofi-Synthelabo*, 470 F.3d at 1383–84 (finding that district court did not clearly err in concluding that the significant public interest in encouraging investment in development and protecting the exclusionary rights conveyed in valid patents tipped the scale in favor of pharmaceutical patent holder).

In some cases, the public interest could weigh heavily enough that a court might deny an injunction even where the patent holder makes a reasonable showing on likelihood of success and irreparable harm. For example, "[i]f a patentee's failure to practice a patented invention frustrates an important public need for the invention, a court need not enjoin infringement of the patent. Accordingly, courts have in rare instances exercised their discretion to deny injunctive relief in order to protect the public interest." *Rite-Hite Corp. v. Kelley Co.*, 56 F.3d 1538, 1547 (Fed. Cir. 1995) (citations omitted). In *z4 Technologies*, the district court found that the public interest weighed against enjoining ongoing infringement. See *z4 Techs. Inc. v. Microsoft Corp.*, 434 F. Supp. 2d 437, 439 (E.D. Tex. 2006). The case involved product activa-

tion software that was used by every genuine purchaser of Microsoft’s popular Windows XP and Office products. *See id.* at 439. Although the jury found willful infringement, the district court declined to order Microsoft to redesign its software or turn off its product activation servers. The court was “unaware of any negative effects that might befall the public in the absence of an injunction,” that “it is likely that any minor disruption to the distribution of the products in question could occur and would have an effect on the public due to the public’s undisputed and enormous reliance on these products” and “[a]lthough these negative effects are somewhat speculative, such potential negative effects on the public weigh, even if only slightly, against granting an injunction.” *Id.* at 443–44. Similarly, when a multifeatured product is involved, the court should consider the prospect that an injunction would deprive customers of access to a large number of desired, noninfringing features. *eBay*, 547 U.S. at 396–97 (Kennedy, J., concurring); *Apple III*, 735 F.3d at 1372–73.

3.2.2.5 Burdens of Proof and Persuasion

The patent holder has the burden of proof to demonstrate the predicates for a preliminary injunction. *See Abbott Labs.*, 452 F.3d at 1334 (Fed. Cir. 2006). This includes the burden of showing that the asserted patents likely are infringed and the absence of any substantial question that the asserted patent claims are valid (*Trebro Mfg.*, 748 F.3d at 1166–67 (Fed. Cir. 2014)), or that the patent is enforceable (*Purdue Pharma*, 237 F.3d at 1366). The validity and enforceability determinations should be made in light of the presumption of patent validity and that the accused infringer has the ultimate burden of proof on these issues at trial. *See, e.g., Sciele Pharma.*, 684 F.3d 1253, 1259 (Fed. Cir. 2012); *Amazon.com*, 239 F.3d at 1350.

The patentee may make its showing of patent validity and enforceability based on the patent’s prosecution history, prior litigation involving the patent, or other evidence such as industry having “acquiesced in” the patent’s validity (e.g., competitors having paid royalties to license it). *See Amazon.com*, 239 F.3d at 1359; *Eyeticor Corp. v. Unisys Corp.*, 155 F. Supp. 2d 527, 542–43 (E.D. Va. 2001) (citing *H.H. Robertson, Co. v. United Steel Deck, Inc.*, 820 F.2d 384, 388–89 (Fed. Cir. 1987)).

Once the patent holder makes its showing, the accused infringer must come forward with evidence that raises a “substantial question” of invalidity. *Amazon.com*, 239 F.3d at 1358. However, validity challenges can defeat a preliminary injunction application “on evidence that would not suffice to support a judgment of invalidity at trial.” *Id.* at 1358–59. At the preliminary injunction stage, the defendant need not meet the “clear and convincing” burden of proof it must meet to prevail on invalidity or unenforceability at trial. *Id.* (“Vulnerability is the issue at the preliminary injunction stage, while validity is the issue at trial. The showing of a substantial question as to invalidity thus requires less proof than the clear and convincing showing necessary to establish invalidity itself.”).

3.2.2.6 Effect of PTAB Review Proceedings

Where a patentee moves for a preliminary injunction with regard to a patent that is subject to pending AIA Review, reexamination, or interference proceedings at the USPTO, the question arises whether those proceedings constitute evidence of substantial doubt as to the validity of the patent.

As discussed in § 14.2.5.6.1, the USPTO grants reexamination requests when it determines that a “substantial new question of patentability” has been raised. § 303. In contrast, the USPTO grants an inter partes review (IPR) request when the petitioner has demonstrated a reasonable likelihood that at least one challenged claim is unpatentable, § 314, and the petitioner must show a claim is more likely than not unpatentable for the USPTO to institute covered business method review (CBMR) or postgrant review (PGR). § 324; § 14.2.5.7.

3.2.2.6.1 Grant of Ex Parte Reexamination

In the context of reexamination, the Federal Circuit has stated that “validity challenges during preliminary injunction proceedings can be successful, that is, they may raise substantial questions of invalidity, on evidence that would not suffice to support a judgment of invalidity at trial.” *Amazon.com*, 239 F.3d at 1358. This suggests that the USPTO’s grant of a reexamination request supports an accused infringer’s invalidity argument at the preliminary injunction stage. *See Pergo, Inc. v. Faus Grp., Inc.*, 401 F. Supp. 2d 515, 524 (E.D.N.C. 2005) (“[W]hile the grant of a motion for reexamination is not conclusive as to the issue of validity, it is probative to the issue of whether defendants have raised a substantial question of validity.”); *DUSA Pharm., Inc. v. River’s Edge Pharm.*, No. 06-1843(SRC), 2007 WL 748448, 2007 U.S. Dist. LEXIS 16005, at *9 (D.N.J. Mar. 7, 2007) (reaching a similar conclusion). Of course, extending the grant of a reexamination request to support the denial of a preliminary injunction requires the assumption that a “substantial new question of patentability” has the same meaning as a substantial question about the merits of a patent holder’s case. In applying *Seagate* to a willfulness analysis, one district court made this assumption: “To the extent the Court accepts the USPTO’s determinations that there are substantial questions of validity, the Court grants partial summary judgment of no willful infringement with respect to post-filing conduct.” *Lucent Techs., Inc. v. Gateway, Inc.*, Nos. 07-CV-2000-H (CAB), 02-CV-2060-B (CAB), 03-CV-0699-B (CAB), 03-CV-1108-B (CAB), 2007 WL 6955272, 2007 U.S. Dist. LEXIS 95934, at *18–19 (S.D. Cal. Oct. 30, 2007) (reasoning that, because there was a substantial question, there could have been no willful infringement).

On the other hand, in the context of a willfulness inquiry, the Federal Circuit has stated that “the grant by the examiner of a request for reexamination is not probative of unpatentability. The grant of a request for reexamination, although surely evidence that the criterion for reexamination has been met . . . does not establish a *likelihood* of patent invalidity.” *Hoechst Celanese Corp. v. BP Chems. Ltd.*, 78 F.3d 1575, 1584 (Fed. Cir. 1996) (emphasis added). Accordingly, while a court should consider the arguments raised in a request for reexamination, and should probe the patent holders’ counterarguments to assess their persuasiveness, the reexamination grant

itself likely is not enough to warrant denial of a preliminary injunction. *Cf. DUSA Pharm.*, 2007 WL 748448, 2007 U.S. Dist. LEXIS 16005, at *10 (D.N.J. Mar. 6, 2007) (granting motion to dissolve preliminary injunction where patent holder “ha[d] not shown that the validity question raised by the reexamination order and the Office Action lacks substantial merit”).

3.2.2.6.2 Institution of Inter Partes Review, Covered Business Method Review, or Postgrant Review

While few courts have addressed what effect the institution of an AIA review has in the preliminary injunction analysis, the higher burdens for institution relative to reexamination seem to favor an accused infringer’s invalidity argument. IPR’s “reasonable likelihood” standard was intended to force the petitioner to make a stronger showing of unpatentability compared to the “substantial question” patentability standard used for reexamination. And the “more likely than not” standard for CBMR and PGR was intended to be an even higher burden.

This has proven to be the case. In the last two years, the PTAB has instituted 75% of IPR requests and 73% of CBMR requests, both much lower than the historical 93% of requests granted for reexamination. *See* http://www.uspto.gov/sites/default/files/documents/041615_aia_stat_graph.pdf; http://www.uspto.gov/patents/stats/inter_parte_historical_stats_roll_up_EOY2013.pdf. Although this would seem to provide more support for an accused infringer’s invalidity argument at the preliminary injunction stage, few courts have grappled with this issue. The court in *Power Survey, LLC v. Premier Utility Services, LLC*, No. 13-5670, 2015 WL 687716, 2015 U.S. Dist. LEXIS 19139, at *6 (D.N.J. Feb. 18, 2015), for example, denied the defendant’s motion to reconsider a preliminary injunction order after the PTAB subsequently granted the defendant’s IPR petition requesting review of all claims of the patent. The court explained that during the preliminary injunction hearing, the defendant disclaimed reliance on the prior art the PTAB used to institute review. *Id.* at *4–5. The court noted that a “strategic decision to present different evidence in federal court than in an administrative court does not entitle a party to reconsideration simply because the administrative court later initiated review based on alleged facts and argument—including argument explicitly disclaimed before this Court.” *Id.* at *6.

3.2.2.6.3 PTAB Cancellation or Rejection of Claims

Where the reexamination proceeding has progressed beyond a grant, and some or all patent claims have been rejected by the PTO, such evidence should weigh in the court’s analysis—although it is not dispositive of the likelihood of the patent’s withstanding a validity challenge. *See Tap Pharm. Prods. v. Atrix Labs., Inc.*, No. 03 C 7822, 2004 WL 2034073, 2004 U.S. Dist. LEXIS 17118, at *8 (N.D. Ill. Aug. 26, 2004) (“Since the PTO’s [reexamination] proceeding has only passed its first stages, I have had difficulty determining what bearing the PTO’s preliminary invalidation of the ’721 patent should have in these proceedings. At the very minimum, however, the PTO’s invalidation raises a substantial question about the patent’s validity and is,

therefore, fatal to a motion for a preliminary injunction.”). A similar analysis should apply to claims canceled in IPR, CBMR, or PGR proceedings.

Note that infringement and validity are determined on a claim-by-claim basis. It is important that the court evaluate each claim that is asserted as the basis for preliminary relief.

3.3 Temporary/Ex Parte Orders

3.3.1 Generally

As in any other case, a temporary restraining order [TRO] “is available under FRCP 65 to a [patent] litigant facing a threat of irreparable harm before a preliminary injunction hearing can be held.” *Fairchild Semiconductor Corp. v. Third Dimension (3D) Semiconductor, Inc.*, 564 F. Supp. 2d 63, 66 (D. Me. 2008) (citing Charles Alan Wright & Arthur R. Miller, *Federal Practice and Procedure* § 2951 (3d ed. 2008)). The Supreme Court has explained that “*ex parte* temporary restraining orders are no doubt necessary in certain circumstances, but under federal law they should be restricted to serving their underlying purpose of preserving the status quo and preventing irreparable harm just so long as is necessary to hold a hearing, and no longer.” *Granny Goose Foods, Inc. v. Bhd. of Teamsters Local 70*, 415 U.S. 423, 439 (1974) (citation omitted). Entering a TRO enjoining the practice of a given technology can have extreme consequences, including the complete shutdown of a competitor’s business. Further, the factual and legal complexity of patent cases makes it difficult—if not impossible—for a court to make the sort of hair-trigger decisions necessary to grant a TRO application. These considerations render the Supreme Court’s cautionary guidance in *Granny Goose* even more forceful in a patent case.

Consequently, as a practical matter, TROs are exceedingly rare in patent cases. With the possible exception of blatant copying of technology in a patent that has previously withstood legal challenge, TROs are almost never granted in the face of competition between legitimate businesses. Likewise, as it is most difficult for a non-practicing entity to prove irreparable harm in the time frame associated with a TRO, TROs in such cases should be similarly rare.

In evaluating an *ex parte* TRO application a court assesses the same four factors as for a preliminary injunction: likelihood of success on the merits, irreparable harm, balance of hardships, and public interest. A TRO may be granted only on a clear showing of *immediate* irreparable injury. Fed. R. Civ. P. 65(b)(1)(A); *Rhino Ass’n, L.P. v. Berg Mfg. and Sales Corp.*, Civil Action No. 1:04-CV-1611, Order Granting Temporary Restraining Order (Docket No. 44) (M.D. Pa. July 1, 2005) (granting a TRO where “continuing manufacture and sale of the infringing products present a *serious and immediate risk* to plaintiff of loss of good will in its customer base and of cascading and undefinable loss of revenues due to resales of the infringing products”) (emphasis added). In a patent case, assessment of the merits of a TRO application will typically touch on factual and expert discovery in most, if not all, aspects of the case. The time required to address the application, therefore, often dictates that it be evaluated in the context of a later preliminary injunction hearing. *See*,

e.g., *Robotic Vision Sys. v. View Eng'g*, No. CV 95-7441 LGB (AJWx), 1996 WL 383900, 1996 U.S. Dist. LEXIS 11917, at *2–3 (C.D. Cal. Mar. 1, 1996), *rev'd in part, vacated in part by Robotic Vision Sys., Inc. v. View Eng'g*, 112 F.3d 1163 (Fed. Cir. 1997).

While a preliminary injunction may be issued only on notice to the adverse party, a TRO may issue without such notice. Fed. R. Civ. P. 65(a)(1), 65(b)(1). Nonetheless, where an adverse party has adequate notice of an application for a TRO, such that a meaningful adversarial hearing on the issues may be held, the court may treat an application for TRO as a motion for preliminary injunction. See *CVI/Beta Ventures v. Custom Optical Frames*, 859 F. Supp. 945, 948 (D. Md. 1994) (citing Charles Alan Wright & Arthur R. Miller, *Federal Practice and Procedure*, § 2951 (1973)).

3.3.2 Procedure

Courts have discretion to handle the attendant hearing, scheduling, and expedited discovery associated with TRO applications in a manner that best suits the circumstances of an individual case. The court may grant or deny the ex parte application without a hearing. Alternatively, the court may decline to rule on the TRO application until the adverse party has had an opportunity to respond. See *Chem-Tainer Indus. v. Wilkin*, No. CV 97-0829LGB(EX), 1997 WL 715014, 1997 U.S. Dist. LEXIS 17241, at *3 (C.D. Cal. Feb. 24, 1997) (“The Court declined to rule on the TRO application. Instead, the Court set a hearing . . . and ordered Chem-Tainer’s counsel to serve the papers on Defendant that same day . . . and to inform Defendant of the hearing and that any opposition was due . . .”). The court may also decide to combine the hearings and discovery for the TRO with a pending preliminary injunction application. *Robotic Vision Sys. v. View Eng'g*, 1996 WL 383900, 1996 U.S. Dist. LEXIS 11917, at *2–3 (C.D. Cal. Mar. 1, 1996) *rev'd on other grounds*, 112 F.3d 1163 (Fed. Cir. 1997).

In determining the proper procedure, courts balance the heavy burden on the parties—often the required expedited discovery will require double and triple tracking of depositions—against the necessity for quick resolution of the applications. As discussed further below, assessing the merits of a TRO or preliminary injunction application could conceivably require discovery into nearly every aspect of the case. At a minimum, plaintiffs will likely seek documents and deposition testimony regarding the structure and function of accused products (relevant to infringement allegations) and market and financial data (relative to irreparable harm). Defendants will seek discovery relating to the plaintiff’s patents, including their prosecution, and possibly the sale of plaintiff’s products covered by the patents (relevant to invalidity and potential on-sale bar allegations). Defendants may also seek financial data relevant to the amount of bond necessary should a preliminary injunction issue. Both parties may offer experts for both claim construction (if claim terms have particular meaning in the industry) and infringement.

Thus, from a practical standpoint, for a court to consider a TRO application, the parties must focus the issues to permit an expeditious resolution of the TRO applica-

tion. Even if the issues are focused, factual complexity almost always precludes meaningful TRO relief. Therefore, the TRO application usually is best treated as a preliminary injunction application. Depending on information developed in initial discovery and on the actions of the parties, the court may modify the discovery, briefing, and hearing schedules. See *CVI/Beta Ventures*, 859 F. Supp. at 946–48 (describing the court’s evolving approach to discovery and hearing related to a TRO application, in which the court ultimately treated the request as a preliminary injunction application because the defendant was determined to have notice and opportunity to respond). At all times, the objective under Federal Rule of Civil Procedure 65(b) should be to preserve the status quo, protect the rights of the patent holder, and “ensure that parties subject to [TROs] are given an opportunity to present their case as soon as possible.” *Id.* (granting preliminary injunction, but ordering a hearing for reconsideration after further discovery was completed).

3.4 Discovery

Discovery relating to a preliminary injunction application can touch on nearly every substantive issue in a patent case. Claim construction is usually required, which in turn may require expert discovery if certain terms have special meaning in the art. The plaintiff may require fact and expert testimony as to the defendant’s products, including their development, structure, and operation. The plaintiff’s irreparable harm allegations may require fact and expert discovery as to market conditions and the defendant’s financial condition. The defendant’s invalidity and unenforceability allegations may require discovery into the prosecution of the plaintiff’s patents (especially where the defendant asserts inequitable conduct) and sales by the plaintiff of products covered by the patent as relevant to a potential on-sale bar argument. The defendants might also seek financial data relevant to the amount of bond necessary should a TRO or preliminary injunction issue.

The initial challenge for a court confronting a preliminary injunction application in a patent case is balancing the need to resolve the application based on a reasonably full record against the twin considerations that a preliminary injunction proceeding needs to be resolved expeditiously and that the parties need to conduct their business in the interim. Where a preliminary injunction application is filed prior to the initiation of discovery, expedited discovery may be ordered upon motion or stipulation. See *Semitool, Inc. v. Tokyo Elec. Am.*, 208 F.R.D. 273, 276 (N.D. Cal. 2002) (explaining that “good cause [for expedited discovery] may be found where the need for expedited discovery, in consideration of the administration of justice, outweighs the prejudice to the responding party. It should be noted that courts have recognized that good cause is frequently found in cases involving claims of infringement;” granting motion where plaintiff sought narrowly defined “core” discovery but denying motion as to third-party expedited discovery); Fed. R. Civ. P. 26(d).

The parties should be encouraged to confer and stipulate with respect to a discovery and hearing schedule to the extent feasible. In finalizing the schedule, courts consider whether the parties have already engaged in discovery in the instant litigation or a related matter, the complexity of the technology, any delay by the plaintiff

in bringing its preliminary injunction application (which weighs against aggressive expediting), see *Power Integrations, Inc. v. BCD Semiconductor Corp.*, C.A. No. 07-633-JJF-LPS, 2008 WL 496446, 2008 U.S. Dist. LEXIS 16021, at *3-4 (D. Del. Feb. 11, 2008), the necessity for expert discovery, and other considerations unique to the case. Depending on the facts, discovery and hearing may be set on a shortened schedule or may need to be delayed for weeks or even months. Compare *Power Integrations*, 2008 WL 496446, 2008 U.S. Dist. LEXIS 16021, at *3-4 (finding expedited discovery appropriate and setting time to preliminary injunction hearing of eighty-five days) with *Furminator, Inc. v. Ontel Prods. Corp.*, 246 F.R.D. 579, 581 (E.D. Mo. 2007) (granting plaintiff's request for expedited discovery and setting the hearing for February 14, after plaintiff filed motion on January 24).

The general strategies for patent case management apply here, but with even greater force. Courts should use every means to encourage the parties to focus the issues and should keep a watchful eye for signs that the parties are using litigation tactics as a business lever: attempting to gain access to a competitor's confidential business information, disrupting a competitor's business with burdensome discovery, or driving a competitor out of business by running up litigation bills—a particular concern where one or both parties is a small or new company.³ For purposes of the preliminary injunction, the court should, therefore, consider strictly limiting:

1. the number of patent claims and prior art references that may be asserted
2. the number of claim terms that will be construed
3. the number of depositions that may be taken (Consider allowing each side to take one 30(b)(6) deposition—on the accused product and on the prosecution of the patents—without precluding later 30(b)(6) depositions. See, e.g., *Eyickett Corp.*, 155 F. Supp. 2d at 530 (E.D. Va. 2001) (allowing limited expedited discovery in which each party was permitted to depose two key witnesses prior to the preliminary injunction hearing).)
4. the number and nature of document requests (This is an area particularly subject to abuse.)
5. the issues to be considered (To the extent appropriate, screen out financial argument. Sales and profits likely need not be discovered absent a party's convincing showing that lost sales could not be remedied in damages. If financial discovery is necessary to determine a proper bond amount, consider bifurcating this issue pending a decision on the application. Also, consider whether the preliminary injunction briefing and argument need to address the doctrine of equivalents. (Where prosecution history has limited a patent's scope on a key claim term, a patent holder could face a very high bar in showing likelihood of success on the merits of a doctrine of equivalents argument.))

3. Note that because much of the business information in a patent case is highly confidential, it will likely be necessary for the court to enter a protective order before PI discovery can go forward. On protective orders generally, see § 4.2.5.

3.5 Hearing

3.5.1 Whether to Conduct a Hearing

As with other aspects of case management, a court has considerable discretion as to the handling of a hearing for a TRO or preliminary injunction application. Under Federal Rule of Civil Procedure 65, a court need not have a hearing on a TRO application. Rule 65 is not explicit about whether the court must have a hearing to consider a preliminary injunction. However, as a practical matter given the complexity of patent TRO and preliminary injunction applications, courts generally hear arguments, which is the better practice.

A hearing offers the opportunity to move the case forward significantly. Evidence received on a preliminary injunction motion that would be admissible at trial “becomes part of the trial record and need not be repeated at trial.” Fed. R. Civ. P. 65(a)(2). Note, however, that, to the extent a party has preserved the right to jury trial, the evidence may have to be repeated to the jury if the matter goes to trial. *See* Fed. R. Civ. P. 65(a)(2) Advisory Committee’s Note (“[T]he jury will have to hear all the evidence bearing on its verdict, even if some part of the evidence has already been heard by the judge alone on the application for the preliminary injunction.”).

As discussed further in § 3.6, the court may dispose of certain issues by advancing their trial on the merits. *See id.*

3.5.2 Notice and Scheduling

“The court may issue a preliminary injunction only on notice to the adverse party.” Fed. R. Civ. P. 65(a)(1). Notice must be effective as to all parties that will be bound by the order. Fed. R. Civ. P. 65(d) (“[An order granting an injunction] is binding upon the parties to the action, their officers, agents, servants, employees, and attorneys, and upon those persons in active concert or participation with them who receive actual notice of the order by personal service or otherwise.”); *see also Dentsply Int’l, Inc. v. Kerr Mfg. Co.*, 42 F. Supp. 2d 385, 394–400 (D. Del. 1999) (analyzing whether nonparty was bound by injunction and concluding that nonparty was in privity with party and was therefore bound).

If expedited discovery relating to the preliminary injunction application is an issue, the preliminary injunction hearing may be set following a conference with the parties during which the court should explore the discovery that will be necessary to address the merits of the application. *See* § 3.4 (discussing strategies for focusing this discovery). Discovery for preliminary injunction applications is necessarily expedited and can be quite burdensome. Nevertheless, as discussed in § 3.4, it is not uncommon for this discovery to take several weeks or longer because of the breadth of fact and expert discovery that may be required for a preliminary injunction application in a new patent case.

3.5.3 Evidentiary Showing—What to Expect

As discussed above, the analysis of a preliminary injunction application can touch on nearly every aspect of a patent case. Evidence that will likely be brought to the court during the preliminary injunction process includes:

- *Claim construction*: fact evidence as to the prosecution of the patent and any limitations imposed on claim meaning and/or available equivalents; expert testimony as to special meanings of claim terms in the industry.
- *Infringement*: fact and expert evidence as to structure and operation of accused products and comparison of accused products to patent claim terms.
- *Validity/enforceability*: fact and expert evidence as to allegedly invalidating prior art references; fact evidence as to alleged inequitable conduct or other unenforceability defenses.
- *Irreparable harm*: fact and expert evidence as to market conditions and growth projections, status of the parties in the industry (e.g., market leader, new entrant to market, etc.), special circumstances (e.g., approaching holiday sales or changes in the market brought on by legislation or regulatory action).
- *Other*: evidence relating to public interest, such as the public’s need for an accused medical device or pharmaceutical; evidence relating to the proper bond amount.

3.6 Rule 65 Trial

As can be seen from the above, the bulk of the substance of a patent case will be in play in deciding a preliminary injunction motion. Depending on the facts of a given case, one or more issues may be ripe for final disposition, even at this early stage.

For example, a defendant may argue that its product is noninfringing because it is clear that a particular claim element is not in its revised product and that plaintiff is using patent litigation as a tactic to disrupt or destroy defendant’s business. In such a case, Rule 65 presents the court and the litigation “victim” with an opportunity in the form of an early trial on the merits, through consolidation with the preliminary injunction hearing. *See* Fed. R. Civ. P. 65(a)(2). Likewise, where a prior art reference or inequitable conduct allegation appears convincingly to render a patent invalid or unenforceable, a Rule 65 trial may be warranted.

While an early trial may require front loading of casework by both the parties and the court, the benefits can be substantial. First, while the result of a preliminary injunction motion provides the parties early notice of the relative strengths of their cases, a Rule 65 trial crystallizes the parties’ positions with respect to the issues it resolves—and these issues tend to be pivotal. The plaintiff who loses on infringement on its “best” claim, or the defendant who loses on its “best shot” invalidating prior art-reference will have strong reasons to reassess whether pressing forward with the litigation is wise, or whether settlement and/or dismissal of the case makes better business sense. Second, the court’s offer of a Rule 65 trial gives an opportunity to force the hand of litigants that are misusing the litigation process. Foot-dragging by a plaintiff that claims an infringement case is simple and straightforward may be a

sign of misleading representations or pursuit of ulterior motives. Finally, the evidence presented during the trial becomes part of the record of the case. Nonetheless, the evidence may have to be repeated to the jury if the matter goes to trial. *See* Fed. R. Civ. P. 65(a)(2) Advisory Committee’s Note; § 3.5.1.

A district court may order advancement of trial and consolidation with a preliminary injunction hearing on its own motion. Fed. R. Civ. P. 65(a)(2). Of course, the decision to do so must be tempered by due process considerations. *See, e.g., Pughsley v. 3750 Lake Shore Drive Coop. Bldg.*, 463 F.2d 1055, 1057 (7th Cir. 1972). Parties “should be given a clear opportunity to object, or to suggest special procedures, if a consolidation is to be ordered.” *Id.*

The answers to the following questions may help the district court and the parties determine whether to proceed with the preliminary injunction motion or an expedited trial on the merits:

1. What is the urgency that requires a prompt hearing?
2. Can complete relief be provided if the case proceeds to an expedited trial on the merits?
3. Will the plaintiff be able to post an injunction bond?
4. Can a standstill agreement be worked out between the parties, with or without a bond?
5. How long will it take the parties to be ready for a trial on the merits?
6. How long will it take the parties to be ready for a preliminary injunction hearing?
7. Can the parties afford the possibility of two rounds of discovery, two trials, and two appeals?
8. Will there be a jury demand?
9. Does it make sense to bifurcate liability from the damages remedy?
10. How much time will a trial on the merits take compared to a hearing on the preliminary injunction?

Morton Denlow, *The Motion for a Preliminary Injunction: Time for a Uniform Federal Standard*, 22 Rev. Litig. 495, 536 (2003).⁴

3.7 Bond

No restraining order or preliminary injunction shall issue except upon the giving of security by the applicant, in such sum as the court deems proper, for the payment of such costs and damages as may be incurred or suffered by any party who is found to have been wrongfully enjoined or restrained.

Fed. R. Civ. P. 65(c). Because the amount of the security bond is a procedural issue not unique to patent law, the amount is determined according to the law of the dis-

4. The author was, at the time that he wrote this article, a U.S. magistrate judge for the Northern District of Illinois.

trict court's regional circuit. See *Int'l Game Tech. v. WMS Gaming Inc.*, No. 98-1361, 1999 U.S. App. LEXIS 22971217 F.3d 850, at *4 n.1 (Fed. Cir. Sept. 3, 1999) (unpublished opinion; decision without published opinion at 217 F.3d 850 (Fed. Cir. Sept. 3, 1999)).

The amount of a bond rests within the sound discretion of a trial court. See *Sanofi-Synthelabo*, 470 F.3d at 1384–85 (citing *Doctor's Assocs., Inc. v. Distajo*, 107 F.3d 126, 136 (2d Cir. 1997)).

A court may exercise discretion in the procedure it follows for argument and decision on a bond amount. Briefing and argument may be made along with briefing on the merits or may be postponed until after the decision on the injunction. See, e.g., *Eisai Co. v. Teva Pharms. USA, Inc.*, Civ. Nos. 05-5727 (HAA)(ES), 07-5489 (HAA)(ES), 2008 WL 1722098, 2008 U.S. Dist. LEXIS 33747 at *38 (D.N.J. Mar. 28, 2008) (“[T]he Court will require Eisai to post security in an amount sufficient to compensate Teva should the injunction later be found to be unjustified. Therefore, the parties shall submit evidence concerning the proper amount of bond.”); *Warrior Sports, Inc. v. STX, L.L.C.*, 2008 WL 783768, 2008 U.S. Dist. LEXIS 21387 at *1 (E.D. Mich. Mar. 19, 2008) (“[T]he Court grants the Motion, but in order to determine the appropriate amount of bond, holds it in abeyance pending receipt of Defendant’s estimated lost profits.”). Of course, if briefing on this issue is postponed, it should be required within a reasonably short time after an injunction is ordered, because the injunction cannot take effect until the bond is posted. See *Warrior Sports*, 2008 U.S. Dist. LEXIS 21387, at *37 (ordering submittal of lost-profits estimate five days after order granting injunction); *Eisai*, 2008 U.S. Dist. LEXIS 33747, at *38 (presenting evidence on bond amount within two weeks after an order granting injunction).

Discovery relating to bond amount is often intertwined with discovery relating to irreparable harm. However, the quantitative data necessary to evaluate the proper bond amount may require more in-depth discovery of financial documents than the irreparable harm analysis would require.

3.8 Order

3.8.1 Specificity

To withstand appeal, a court’s order must comply with Rule 65’s requirements which expressly address the factors considered in granting or denying the injunction. Fed. R. Civ. P. 65(d)(1)(A). It must also specifically describe the infringing actions enjoined, with reference to particular products. See Fed. R. Civ. P. 65(d)(1)(C). While a denial may be based on a finding that the movant has failed to demonstrate likelihood of success on the merits or irreparable harm, see, e.g., *Novo Nordisk*, 2008 WL 6098829, 2008 U.S. Dist. LEXIS 12342, a grant must be based on an assessment of both of these factors as well as the balance of harms and public interest. The structure of an order granting a preliminary injunction should systematically address each of these issues, providing the court’s reasoning and conclusion. The order should also address the technology at issue as well as the scope of the injunction and the amount of the bond. The preliminary injunction order in *Oakley, Inc. v. Sunglass*

Hut Int'l, No. SA CV 01-1065 AHS, 2001 WL 1683252, 2001 U.S. Dist. LEXIS 23572 (C.D. Cal. Dec. 7, 2001) (*aff'd*, *Oakley, Inc. v. Sunglass Hut Int'l*, 316 F.3d 1331, 1346 (Fed. Cir. 2003)), suggesting the following general outline, is an example of such a well-drafted order:

- (1) Introductory material. Describe the parties, patents, and technology at issue. *See id.* at *6–10.
- (2) Claim construction. Perform preliminary construction of key claim terms. *See id.* at *11–12. Recall that the court’s construction for preliminary injunction purposes can be revisited.
- (3) Likelihood of Success on the Merits:
 - a. Infringement—analyze whether the accused devices have every element of any asserted claim under the court’s construction. *See id.* at *10–14.
 - b. Validity—analyze asserted invalidity contentions. *See id.* at *15–29.
 - c. Enforceability—analyze asserted inequitable conduct arguments and/or other unenforceability arguments. *See id.* at *30–31.
 - d. Conclusion—decide whether the movant has shown it will likely prevail in showing infringement and in countering opponent’s invalidity and/or unenforceability arguments. *See id.* at *31.
- (4) Irreparable Harm. *See id.* at *31–34. Note that the district court in *Oakley* recited a presumption of irreparable harm but also analyzed actual harm. As explained above (*see* § 3.2.2.2.1) *Robert Bosch LLC*, 659 F.3d at 1148–49, made clear irreparable harm no longer is presumed. Therefore, it is necessary for the order to analyze actual harm.
- (5) Balance of Harms. *See id.* at *34.
- (6) Public Interest. *See id.* at *34–35.
- (7) Scope of Injunction. *Id.* at *3. Note that, while the court’s description of the acts enjoined was somewhat cursory, the Federal Circuit affirmed, explaining that the enjoined party demonstrated its understanding of the enjoined acts by way of its actions in response to the similarly worded TRO. *Oakley*, 316 F.3d at 1346.
- (8) Amount of Bond. *See id.* at **35–36.

A template for drafting an order granting a preliminary injunction is provided in Appendix 3.1.

Depending on the facts of the case, the court may also need to address the persons bound by the order. (*See* § 3.8.2.) As can be seen from this outline, a well-drafted order granting a preliminary injunction can be a complicated and lengthy document that is time-consuming and challenging to prepare. This is one more reason to apply the strategies described above, *see* § 3.4, to encourage the parties to narrow and focus the issues.

3.8.2 Parties Affected

A court's preliminary injunction can bind "only the following who receive actual notice . . . (A) the parties; (B) the parties' officers, agents, servants, employees, and attorney; and (C) other persons who are in active concert or participation with anyone described in [parts (A) or (B)]." Fed. R. Civ. P. 65(d)(2). In applying Rule 65(d), the Federal Circuit has emphasized that "a court may not enter an injunction against a person who has not been made a party to the case before it." *Additive Controls & Measurement Sys., Inc. v. Flowdata, Inc.*, 96 F.3d 1390, 1394 (Fed. Cir. 1996).

A court is not, however, powerless against nonparties that act to frustrate a preliminary injunction. "[T]hose who act in concert with an enjoined party may be held in contempt, but only for assisting the enjoined party in violating the injunction." *Id.* (citing *Spindelfabrik Suessen-Schurr v. Schubert & Salzer Maschinenfabrik Aktiengesellschaft*, 903 F.2d 1568, 1580–81 (Fed. Cir. 1990)); Fed. R. Civ. P. 65(d)(2)(C). As the Federal Circuit explained in a second *Additive Controls* case, "[n]on-parties may be held in contempt . . . if they either abet the defendant, or are legally identified with him." *Additive Controls*, 154 F.3d at 1351 (considering whether a resigned corporate officer was "legally identified" with a corporation and listing factors that might influence the fact-specific inquiry) (quoting *Alemite Mfg. Co. v. Staff*, 42 F.2d 832, 833 (2d Cir. 1930)); see also *Power-One, Inc. v. Artesyn Techs., Inc.*, Civ. Action No. 2:05-CV-463, 2008 WL 1746636, 2008 U.S. Dist. LEXIS 30338, at *10–11 (E.D. Tex. Apr. 11, 2008) (concluding that certain nonparties could not be named in an injunction, as they had not appeared before the court to have their rights adjudicated, but crafting an injunction that encompassed "successors in interest" to or persons "in active concert" with the named parties). While a party need not intend to violate an injunction to be found in contempt, nonparties may be found in contempt only if they are aware of the injunction and know that their acts, made in concert with an enjoined party, violate the injunction. *Additive Controls*, 154 F.3d at 1353. That is, the non-party must know both that the acts are proscribed and that the person(s) with whom they are acting are subject to the injunction. *Id.* at 1353–54.

3.8.3 Modification

Modification of a preliminary injunction in a patent case may be necessary to address new facts or circumstances. For example, an enjoined accused infringer may place a new product on the market through which it has attempted, but failed, to design around a patent-in-suit. In such a case, the court may modify its preliminary injunction to include the manufacture and sale of the new product in the scope of enjoined actions. See *SEB S.A. v. Montgomery Ward & Co.*, 137 F. Supp. 2d 285, 287 (S.D.N.Y. 2001) ("Finding that the modified fryer infringes the '312 Patent by equivalences, this Court grants SEB further injunction relief . . ."). Consideration of the motion for modification requires analysis of the same factors as are required for the initial grant of the preliminary injunction. See *id.* at 287–91. The objective in modifying the injunction should be to maintain the status quo. See *id.* ("Enjoining the sale of the modified fryer will restore the status quo.") (citing *Atlas Powder*, 773 F.2d at

1231). Courts may also modify preliminary injunction orders to encompass additional, potentially infringing products that come to light during discovery, include newly issued patents, or remove expired patents.

3.9 Appellate Review

A district court's decision on a motion for preliminary injunction is usually immediately appealable, whether it has decided to grant or deny the injunction. 28 U.S.C. § 1292(a)(1).⁵ As an abstract principle, the grant or denial of a preliminary injunction is a procedural issue that is not unique to the exclusive jurisdiction of the Federal Circuit. *Tex. Instruments, Inc. v. Tessera, Inc.*, 231 F.3d 1325, 1327 (Fed. Cir. 2000). When reviewing “procedural matters not unique to the areas that are exclusively assigned to the Federal Circuit,” the Federal Circuit generally applies the procedural law of the regional circuit where the case originated. *Id.* (quoting *Nat'l Presto Indus., Inc. v. W. Bend Co.*, 76 F.3d 1185, 1188 n.2 (Fed. Cir. 1996)). However, Federal Circuit precedent applies “to uniformly deal with procedural matters arising from substantive issues in areas of law within the unique jurisdiction of this circuit”—such as the grant or denial of a preliminary injunction in a patent case. *Id.*

“A decision to grant or deny a preliminary injunction pursuant to 35 U.S.C. § 283 is within the sound discretion of the district court,” reviewed for abuse of discretion. *Sanofi-Synthelabo*, 470 F.3d 1368, 1374 (Fed. Cir. 2006). “[A] decision granting a preliminary injunction will be overturned on appeal only if it is established ‘that the court made a clear error of judgment in weighing relevant factors or exercised its discretion based upon an error of law or clearly erroneous factual findings.’” *Id.* (quoting *Genentech, Inc. v. Novo Nordisk A/S*, 108 F.3d 1361, 1364 (Fed. Cir. 1997)). However, to the extent a district court's decision is based upon an issue of law, that issue is reviewed de novo. *Id.* Such issues include preliminary claim constructions and obviousness determinations. *Oakley*, 316 F.3d at 1339.

3.9.1 Writ Review

Instead of appealing, a party may seek a writ of mandamus from the Federal Circuit ordering imposition or dissolution of a preliminary injunction. “The remedy of mandamus is available only in extraordinary situations to correct a clear abuse of discretion or usurpation of judicial power. A party seeking a writ bears the burden of proving that it has no other means of attaining the relief desired, and that the right to issuance of the writ is clear and indisputable.” *Razor USA LLC v. ASA Prods., Inc.*, Nos. 01-1080, 636, 637, 638, 2000 WL 1819400, 2000 U.S. App. LEXIS 33182, at *4–5 (Fed. Cir. Nov. 22, 2000) (unpublished opinion) (citations omitted). Accordingly, a party dissatisfied with the outcome of a motion for preliminary injunction should

5. A decision to grant or deny a TRO is not usually appealable. Fed. R. Civ. P. 65; *Nikken USA, Inc. v. Robinson-May, Inc.*, 1999 WL 1046620, 1999 U.S. App. LEXIS 31925 (Fed. Cir. Oct. 25, 1999) (unpublished case).

first seek to stay the result and file a notice of appeal. *In re Lumenis, Inc.*, 89 F. App'x 255, 256 (Fed. Cir. 2004) (“The proper procedure for seeking to stay or vacate an injunction is to file a notice of appeal and a motion in the district court for a stay of the injunction, pending appeal.”) (unpublished opinion).

3.9.2 Stays

A party subjected to a preliminary injunction may ask the district court to stay the injunction pending appeal. See *Razor USA LLC*, 2000 U.S. App. LEXIS 33182, at *4–5 (Fed. Cir. Nov. 22, 2000) (unpublished opinion). “While an appeal is pending . . . from an order . . . that grants, dissolves or denies an injunction, the court may suspend, [or] modify” the injunction. Fed. R. Civ. P. 62(c). Whether to issue a stay of enforcement of a preliminary injunction is within the sound discretion of the district court. *Abbott Labs. v. Sandoz, Inc.*, 500 F. Supp. 2d 846, 849 (N.D. Ill. 2007) (citing Fed. R. Civ. P. 62(c)).

“To obtain a stay, pending appeal, a movant must establish a strong likelihood of success on the merits [of the appeal] or, failing that, nonetheless demonstrate a substantial case on the merits provided that the harm factors militate in its favor.” *Eon-Net, L.P. v. Flagstar Bancorp, Inc.*, 222 F. App'x 970, 971–72 (Fed. Cir. 2007) (citing *Hilton v. Braunskill*, 481 U.S. 770, 778 (1987)). In deciding whether to grant a stay, pending appeal, the court weighs four factors: “(1) whether the stay applicant has made a strong showing that he is likely to succeed on the merits; (2) whether the applicant will be irreparably injured absent a stay; (3) whether issuance of the stay will substantially injure the other parties interested in the proceeding; and (4) where the public interest lies.” *Standard Havens Prods., Inc. v. Gencor Indus., Inc.*, 897 F.2d 511, 512 (Fed. Cir. 1990) (quoting *Hilton*, 481 U.S. at 776).

As with preliminary injunction determinations, courts apply a flexible approach: “the more likely the plaintiff is to win, the less heavily need the balance of harms weigh in his favor; the less likely he is to win, the more need it weigh in his favor.” *Id.* (quoting *Roland Mach. Co. v. Dresser Indus., Inc.*, 749 F.2d 380, 387–88 (7th Cir. 1984)). “Thus, the four factors can effectively be merged and a sliding scale approach is utilized, which states: ‘in considering whether to grant a stay pending appeal, this court assesses movant’s chances for success on appeal and weighs the equities as they affect the parties and the public.’” *Honeywell Int’l, Inc. v. Universal Avionics Sys. Corp.*, 397 F. Supp. 2d 537, 548 (D. Del. 2005) (quoting *Standard Havens*, 897 F.2d at 513); see also *E. I. du Pont de Nemours & Co. v. Phillips Petroleum Co.*, 835 F.2d 277, 278 (Fed. Cir. 1987).

For a district court that has weighed the equitable factors and issued a preliminary injunction, it may seem unlikely that a consideration of quite similar factors could lead to a decision to stay the injunction. Changed legal or factual circumstances can, of course, change the calculus. For example, in *Standard Havens*, the Federal Circuit stayed an injunction in part because, after the trial court had entered the injunction, the Patent Office rejected all the infringed patent claims in a director-initiated reexamination. 897 F.2d at 514. Other examples could include actual or imminent substantial changes in governing patent law, such as the Supreme Court

or the Federal Circuit en banc deciding to take up the “next” *KSR*, *eBay*, or *Bilski* case.

3.10 Enforcement

A party subject to an injunction will often attempt to modify its product to avoid the patent, that is, to “design around” the patent. Parties may dispute whether the redesigned product still infringes. In such cases, the patent holder will often return to the court, seeking a finding that the infringer is in contempt for having violated the injunction and an order enjoining production and sale of the redesigned product. “[A] judgment of contempt against an enjoined party for violation of an injunction against patent infringement by the making, using or selling of a modified device [requires] a finding that the modified device falls within the admitted or adjudicated scope of the claims and is, therefore, an infringement.” *KSM Fastening Sys., Inc. v. H.A. Jones Co.*, 776 F.2d 1522, 1530 (Fed. Cir. 1985). Accordingly,

[b]efore entering a finding of contempt of an injunction in a patent infringement case, a district court must address two separate questions. The first is whether a contempt hearing is an appropriate forum in which to determine whether a redesigned device infringes, or whether the issue of infringement should be resolved in a separate infringement action. That decision turns on a comparison between the original infringing product and the redesigned device. If the differences are such that “substantial open issues” of infringement are raised by the new device, then contempt proceedings are inappropriate. If contempt proceedings are appropriate, the second question the district court must resolve is whether the new accused device infringes the claims of the patent. Within those general constraints, the district court has broad discretion to determine how best to enforce its injunctive decrees.

Additive Controls, 154 F.3d at 1349 (citing *KSM*, 776 F.2d at 1530–32) (internal citations omitted).

Because expert testimony is often required to resolve the question of whether a redesign (or “workaround”) still infringes, the Federal Circuit has advised that contempt proceedings are usually inappropriate to address the adequacy of the design-around effort. *Id.* at 1349–50 (“[O]ur case law suggests that the need for expert testimony counsels against the use of contempt proceedings to try infringement . . .”); see also *KSM*, 776 F.2d at 1530 (“[P]roceedings by way of contempt should not go forward if there is more than a ‘colorable difference’ in the accused and adjudged devices.”). However, some cases are not so close. Where a redesign is found to be a “mere colorable variation” that raises “no substantial open question of infringement,” a contempt proceeding may be adequate. *Additive Controls*, 154 F.3d at 1349 (affirming district court’s resolution of redesign dispute through contempt proceeding and explaining that “the district court satisfied the procedural requirements of *KSM* by separately analyzing the questions whether contempt proceedings were appropriate and whether the redesigned device infringed the patent”).

Appendix 3.1

Template for Order Granting a Preliminary Injunction

A. Introduction and Background

Describe the parties, patents and technology at issue. Include relevant excerpts from the patents in suit.

B. Claim Construction

Perform preliminary construction of key claim terms. Include any intrinsic or extrinsic evidence relied on for the preliminary construction.

C. Likelihood of Success on the Merits

1. Infringement

Analyze whether the accused devices have every element of any asserted claim under the court's construction.

2. Validity

Analyze asserted invalidity contentions.

3. Enforceability

Analyze asserted inequitable conduct arguments and/or other unenforceability arguments.

4. Conclusion

Decide whether movant has shown it will likely prevail in showing infringement and in countering opponent's invalidity and/or unenforceability arguments.

D. Irreparable Harm

Given that the status of the presumption of irreparable harm is presently uncertain, a court's order granting a preliminary injunction should include analysis of this factor beyond a recitation of the presumption.

E. Balance of Harms

F. Public Interest

G. Scope of Injunction

H. Amount of Bond

Chapter 4 Discovery

- 4.1 Controlling Law and Standard of Review 2
- 4.2 Scope of Patent Discovery 2
 - 4.2.1 Proportionality 2
 - 4.2.2 Initial Disclosures 3
 - 4.2.3 Requests for Production of Documents 5
 - 4.2.3.1 Nonparty Subpoena Requests 6
 - 4.2.4 Interrogatories 7
 - 4.2.5 Depositions 8
 - 4.2.6 Protective Orders—Handling of Confidential Documents 9
 - 4.2.6.1 Overdesignation of Confidential Documents 9
 - 4.2.6.2 Claw-Back Provisions for Privileged Documents 10
 - 4.2.6.3 Prosecution Bars 11
 - 4.2.6.3.1 Prosecution Bars and PTAB Review 12
 - 4.2.7 Foreign Discovery Issues 13
- 4.3 Claim Construction and Discovery 15
- 4.4 Electronic Discovery 15
 - 4.4.1 Overview of Electronic Discovery 15
 - 4.4.2 Electronic Discovery in Patent Cases 17
 - 4.4.2.1 Spoliation in Patent Cases 20
 - 4.4.3 Issues with Specific File Types in Electronic Discovery 21
- 4.5 Management of Discovery Disputes 23
- 4.6 Common Discovery Motions 24
 - 4.6.1 Discovery Regarding Patentee’s Prefiling Investigation 24
 - 4.6.2 Production of Information About Products 25
 - 4.6.3 Contentions About Infringement, Invalidity, and Unenforceability 26
 - 4.6.4 Bifurcation or Stay of Discovery Pending Reexamination of Patent 27
 - 4.6.5 Bifurcation or Stay of Discovery Pending Early Dispositive Motion 27
 - 4.6.6 Bifurcation or Stay of Discovery on Issues Bifurcated for Trial 28
 - 4.6.7 Privilege Waiver Based on Defendant’s Election to Rely on Advice of Counsel 28
 - 4.6.8 Discovery from Patent Prosecution Counsel 29
 - 4.6.9 Access to Confidential Information by Patent Prosecution Counsel 30
 - 4.6.10 License Agreements and Other Third-Party Confidential Information 31
 - 4.6.10.1 Discovery Regarding Prior License and Settlement Negotiations 32
- Appendix 4.1 Table, Circuit Court’s Approach to Sanctions for Spoliation 35
- Appendix 4.2 Federal Circuit Model Order Regarding e-Discovery in Patent Cases 49
- Appendix 4.3 Model Orders for e-Discovery 55

Discovery in patent cases can be exhaustive and exhausting for a variety of structural reasons. First, patent claims and defenses are commonly broad, justifying deep inquiry into product development and financial records. This aspect is only magnified by the emerging emphasis on electronic discovery. Not surprisingly, many technology companies make extensive use of digital technology. Second, patent litigation comes freighted with special issues such as willfulness and inequitable conduct, where concerns over privilege and work product complicate these already difficult matters. Third, the potentially consequential but unpredictable outcomes—large damage awards, the possibility of an injunction—lead counsel to demand every piece of data and sometimes avoid compromise in discovery disputes.

Discovery in patent cases should be managed carefully to promote effective dispute resolution. This chapter reviews the typical categories of information sought,

explains the forces underlying discovery controversies, and notes recent developments in and approaches to electronic discovery. We examine the most common points of dispute and analyze ways of resolving them. We conclude by discussing the most common discovery motions, with particular emphasis on the court's range of discretion and suggested best practices for resolving disagreements.

4.1 Controlling Law and Standard of Review

Where issues of patent law control disposition of a discovery dispute, Federal Circuit law will apply. *Midwest Indus., Inc. v. Karavan Trailers, Inc.*, 175 F.3d 1356 (Fed. Cir. 1999). But in the vast majority of discovery matters, courts should rely on the decisions of their regional circuit interpreting the Federal Rules of Civil Procedure. As in other types of federal civil litigation, discovery rulings are reviewed under an abuse-of-discretion standard.

4.2 Scope of Patent Discovery

Issues unique to patent cases will drive much of the discovery effort. For example, a patentee will typically seek information about development of the accused product or process, marketing and sales by the defendant, including cost and profit margins, and license fees paid by the defendant for comparable technology rights. These categories typically include highly confidential commercial and technical information, kept as trade secrets by the litigants and third parties. The sensitive nature of the information can lead to discovery disputes. Moreover, because patentees usually seek to prove that infringement was willful, they will inquire into defendants' knowledge of the patents, efforts to "design around" them, and opinions of counsel about infringement (if the defendants decide to assert advice of counsel as a defense to a willfulness charge; *see* §§ 4.6.7–4.6.9).

An accused infringer in turn will focus on trying to invalidate the patent, gathering information about conception and reduction to practice of the invention, and pre-filing offers for sale. Inequitable-conduct claims motivate inquiry into the record of prosecution of the patent. Finally, in the search for prior art, the defense may pursue discovery from third parties, often located in other districts or countries.

Thus patent litigation discovery tends to be broad and demanding, touches highly sensitive information, and is extremely expensive. This can lead to highly contentious, unproductive friction between counsel. To assist courts in de-escalating these tensions, we provide some general suggestions for management of the basic discovery tools in patent litigation.

4.2.1 Proportionality

The 2015 amendments to the Federal Rules of Civil Procedure provide courts with new standards and new tools to apply to discovery disputes. The U.S. Supreme Court adopted a number of amendments, including one to Rule 26(b) that limits the scope of discovery to "any nonprivileged matter that is relevant to any party's claim

or defense and proportional to the needs of the case . . .” The “proportionality” requirement is expected to better focus courts and litigants on the expected contribution of discovery to the resolution of the case. For the same reason, the amendment deletes the sentence in Rule 26(b)(1) that states, “Relevant information need not be admissible at the trial if the discovery appears reasonably calculated to lead to the discovery of admissible evidence,” and replaces it with “Information within this scope of discovery need not be admissible in evidence to be discoverable.” Although the original intent of the “reasonably calculated” sentence was not to expand the scope of discovery beyond relevance, the amendment addresses the concern that it has been incorrectly used to do so.

In the note accompanying the amendment to Rule 26, the Federal Rules Advisory Committee reiterated that the parties and the district court “have a collective responsibility to consider the proportionality of all discovery and consider it in resolving discovery disputes.” The amendment serves to return the proportionality calculation to Rule 26(b)(1) by moving it from present Rule 26(b)(2)(C)(iii), slightly rearranged and with one addition. This reinforces the parties’ obligation under Rule 26(g) to consider these factors in making discovery requests, responses, or objections. The committee emphasized that the changes are not intended to permit a party opposing discovery to simply make a boilerplate objection that the discovery is not proportional. Because one factor to be considered in determining proportionality is the amount in controversy, district courts can benefit from a reasoned conversation with the parties about the nature and scope of the case, the amount of any damages sought, and how the case compares to other patent cases, with as much specificity as is possible. This discussion can then provide a useful baseline to judge proportionality as the case progresses, with the understanding that developments in the case or information obtained in discovery may warrant revision of what further discovery is considered “proportional.” At the same time, as the committee noted, the monetary stakes are only one factor to be considered, as are the resources of the parties. District courts must apply the standards in an even-handed manner to prevent the use of discovery to wage a war of attrition or as a device of coercion.

Effective judicial management of discovery disputes is a key component of the amended rules. Not every party may have all the necessary information needed to assess the proportionality factors. To the extent possible, district courts should encourage and enforce the frank exchange of information about relevant information and the burden and expense of providing it. The initial case-management conference, following the parties’ Rule 26(f) conference, is key to ensuring that discovery is on the right path. Sincere and realistic participation in discovery management by both parties and courts will help achieve the “just, speedy, and inexpensive determination” of litigation.

4.2.2 Initial Disclosures

Rule 26 disclosures present few issues unique to patent cases. At the resulting Rule 16(b) conference, competing proposals may be made regarding the number of interrogatories and depositions. Keep in mind that patent cases in general require

more extensive use of discovery tools. For example, it is the unusual patent case that results in fewer than ten depositions.

As noted in Chapter 2, many districts have enacted special local rules for patent cases that require early disclosure of infringement contentions by the patentee, and of invalidity contentions by the defendant. This approach, which can be tailored for particular cases, has the advantage of collapsing into one procedure a major aspect of the “after you; no, after you” discovery impasse that otherwise occurs in patent litigation. That is not to say that requiring exchange of contentions is a panacea; the parties frequently contest the specificity of the other side’s disclosure, for example. But it focuses the parties on the core issues, in particular on preparation for claim construction.

Rule 26(a)(1)(C) requires disclosure of a computation of any category of damages claimed, the documents or other evidence supporting the computation, and materials bearing on the nature and extent of injuries suffered. However, in patent cases, a plaintiff will rarely have access to this information in advance of discovery. As discussed in § 14.4.3.2, patent damages are based on profits lost by the patentee or, at a minimum, the reasonable royalty that the infringer would have paid to license the patented technology, both of which depend on the sales and offers made by the accused infringer. Thus, much of the evidence as to the patentee’s damages resides in the hands of the accused infringer. Accordingly, initial disclosures as to damages typically only describe the types of damages sought (rather than providing a rough computation of the amount of damages sought) and necessarily defer disclosure of documents and other evidence to a date after discovery has been completed. In the past, such minimal disclosures were not normally considered to be deficient.

Recently, however, courts have begun requiring the parties to provide more specificity earlier in the case. As discussed more fully in § 2.6.6, an early disclosure of damages theories can, among other things, help promote settlement and can flag potential legal issues that may prompt early *Daubert* motions and early motions for summary judgment. Furthermore, the identification of specific damages theories early in the case may help identify areas for discovery. *See, e.g.*, §§ 2.6.6, 4.6.10. Such early disclosures are increasingly important as developing patent damages standards have led in recent years to an increase in the volume of challenges to damages theories and evidence that are raised, invariably, right before trial. Of course, requiring the patentee to provide an early damages disclosure is likely to be effective only if the accused infringer provides an even earlier disclosure of information about its business. This ensures that the patentee’s disclosure can take into account information held only by the accused infringer. By requiring parties to exchange damages contentions, and perhaps by taking other measures, such as a shortened damages-related discovery period aimed at accelerating timelines for damages-related issues, courts can frontload more of these disputes and thereby provide themselves with a wider range of practical options for resolving them. Moreover, an early damages estimate can help courts weigh the proportionality factors that pertain to discovery.

4.2.3 Requests for Production of Documents

Reflecting the broad scope of activities relevant to patent cases, it is common for litigants to propound 100 or more document requests. Document requests typically reach into nearly every facet of a party's business, including product research and development, customer service and support, sales, marketing, accounting, and legal affairs. Indeed, for a smaller company that offers a single product line accused of infringing a patent, the document requests may well encompass the vast majority of records ever created in the course of the company's business. The documents must be collected in hard copy form from custodians in nearly every department and in electronic form from both the company's active computer files and all readily accessible archives.

The costs of document production include legal fees for collecting and processing the documents. The documents must be reviewed for privilege and to provide confidentiality designations to protect the party's trade secrets and other confidential information. These fees can rapidly escalate into the millions of dollars for medium to large companies.

Document production also disrupts businesses. It may take several months for counsel working with document custodians and literally hundreds of temporary-employee document reviewers to identify and produce responsive documents. Hard-copy documents must then be removed from the custodians for a period of time for copying. Electronic documents in the company's active computer system may be more readily copied once they are identified, but the effort to pinpoint the relevant documents and copy them distracts the company's information technology (IT) personnel from their ordinary duties. Documents in a company's archives require substantially more time from IT personnel. Identification of responsive documents first requires retrieval of archival tapes or drives, loading the drives, possibly reading the drives using obsolete software, and often searching for responsive documents in file systems created by personnel no longer at the company. In addition, companies often have stores of electronic information that are not centrally maintained—laptop hard drives, for example—that may be difficult to locate or may have been lost before litigation began. An inventor's laptop may have been provisioned to another employee when the inventor upgraded to a new machine; yet relevant data may still exist on a currently unused portion of the laptop's hard drive, unknown to anyone. It can be expensive in absolute terms to find and produce such data, and the ultimate value of the data to the litigation may not justify that cost. The difference in patent litigants' cost/benefit positions often spurs discovery disputes.

In addition, patent litigation often requires the production of technical information that is highly sensitive and difficult to reproduce for production. Some technical information, such as semiconductor schematics, can only be reviewed in native format using proprietary software that is itself valuable and sensitive. Such information may need to be reviewed on-site on the producing parties' computers. Com-

puter source code is also highly sensitive¹ and may need to be reviewed in native format. Often it is produced on a stand-alone computer, unconnected to the Internet and in a secure location, and with limitations imposed on the number of pages that may be printed.

Financial information related to damages is also viewed as highly sensitive and can be difficult to produce. Often in lieu of the underlying financial documents (such as numerous invoices), companies produce reports from their financial databases. They must agree on which categories of information will be produced from these databases or come to terms with the fact that some categories of information cannot be generated by such systems.

Third-party confidential documents, such as patent licenses, are also usually relevant to the damages case, and third-party technical documents can be relevant to the liability case (for example, if a third party makes the accused chip). The production of these documents often requires permission from third parties, the negotiation of protective orders, or even compulsory process and motions practice.

In short, document production can be extremely painful and costly for patent litigants. Document requests in patent cases usually generate multiple motions to compel and/or motions for protective orders. Courts can facilitate more effective document collection and production processes by:

- Reviewing the parties' electronic discovery plan at the case-management conference, as required by Rule 26.
- Requiring the parties to meet and confer to narrow document requests and to document their efforts in any motion to compel.
- Requiring the parties to file a letter brief seeking permission to file a motion to compel or requiring a pre-motion telephonic conference with the Court or with a magistrate or special master prior to the filing of a motion to compel.
- Placing a limitation on the number of document requests permitted per side.

4.2.3.1 Nonparty Subpoena Requests

Nonparty subpoenas are routinely served as part of patent litigation. Federal Rule of Civil Procedure 45 governs nonparty discovery. This rule protects against the disclosure of privileged or other protected matter and the imposition of undue burdens. However, nonparties must otherwise comply with subpoenas, which can involve significant time and expense. Even challenging a subpoena can require considerable effort.

One remedy for nonparties in such situations is cost-shifting. In cases where the court believes the subpoena imposes significant expense on the nonparty, it may

1. Software companies typically distribute their computer programs solely in machine-readable object code (binary) format, while keeping the human-readable source code proprietary. Typically, the great difficulty of decompiling object code into source code enables the source code form of computer programs to qualify as a trade secret. Control of access to source code can be of tremendous strategic importance to software companies.

shift enough of the cost to the party seeking discovery so that the net cost to the nonparty is “nonsignificant.” See, e.g., *Legal Voice v. Stormans Inc.*, 738 F.3d 1178 (9th Cir. 2013); *Linder v. Calero-Portocarrero*, 251 F.3d 178 (D.C. Cir. 2001). Whether or not a cost or fee is “significant” is a discretionary matter for the district court, but at least one district court has ruled that attorneys’ fees may be considered as a cost of compliance. Order Regarding Callwave and Location Labs’ Joint Discovery Dispute Letter at ECF No. 32, *Callwave Commc’n v. Wavemarket Inc.*, No. 35, C 14-80112 JSW (LB) (N.D. Cal. Aug. 29, 2014).

4.2.4 Interrogatories

The Federal Rules of Civil Procedure have a default limit of twenty-five interrogatories per party. In their joint case-management statement, parties often make a joint request for additional interrogatories. These requests should typically be granted as the scope of subject matter in patent litigation is quite broad. Because patent litigation often includes multiple plaintiffs and defendants, however, courts should consider imposing an interrogatory limit per side, rather than per party.

The case-focusing benefit of interrogatories can often be swamped by premature use of contention interrogatories that waste the parties’ efforts before meaningful responses can be developed based on completion of fact and expert discovery. See, e.g., *In re Convergent Techs. Sec. Litig.*, 108 F.R.D. 328, 337 (N.D. Cal. 1985) (observing that “there is substantial reason to believe that the *early* knee-jerk filing of sets of contention interrogatories that systematically track all the allegations in an opposing party’s pleadings is a serious form of discovery abuse. Such comprehensive sets of contention interrogatories can be almost mindlessly generated, can be used to impose great burdens on opponents, and can generate a great deal of counterproductive friction between parties and counsel.”). Conversely, however, appropriately timed contention interrogatories (i.e., after a meaningful opportunity for discovery) can help streamline discovery and flag potential disputes early enough to seek judicial resolution well before trial. This is particularly true in districts that have not adopted patent local rules requiring exchanges of infringement and invalidity contentions. In addition, contention interrogatories provide another vehicle for courts to require parties to disclose their damages theories early enough in the case that fundamental disputes about the viability or legality of damages theories are not relegated to the eve of trial (i.e., during fact discovery)—provided, of course, that responses are not required so early that the answering party has not yet obtained damages-related fact discovery from the opposing party. As discussed further below, requiring complete answers to contention interrogatories should typically be postponed until the late stages of fact discovery. Courts should also be mindful of the fact that some “contentions” are a matter of expert opinion (e.g., what figure constitutes a “reasonable” royalty, in contrast to an established royalty), and should consider giving the parties leave to supplement their contention interrogatory responses at a date after the completion of expert discovery. A court can prevent the all-too-common disputes as to when contention interrogatories should be answered by setting a date (or a series of dates) in the case-management order for the exchange of

responses to these interrogatories, such as a date for initial responses and a date after close of fact discovery for final responses. Section 4.6.3 discusses motion practice relating to contention interrogatories.

4.2.5 Depositions

Federal Rule of Civil Procedure 30(a)(2)(A) limits to ten the number of depositions that may be taken by a party without leave of court. Again, however, as a result of the breadth of discovery in patent cases, and in spite of the more extensive mandatory disclosure requirements imposed by patent local rules, litigants often seek to take in excess of twenty depositions to develop their case, and may legitimately need more than the presumptive ten depositions allowed under Rule 30. The court should strongly encourage the parties to reach mutual agreement in their Rule 26(f) proposed discovery plan regarding the number of depositions or cumulative hours that will be allowed without court order. Absent agreement, a limit should be set to promote the parties' efficient use of the depositions. A limit of fifteen to twenty depositions per side, or about 100 hours, typically provides the parties with plenty of opportunity to cover the major issues in a case. Many judges set significantly lower presumptive limits (e.g., 40 hours per side), allowing the parties to petition for more time where justified. The most common practice is to apply these limits to fact discovery, since expert depositions tend to be self-regulating and do not involve inconvenience to the parties themselves.

The one-person/one-day limitation of Rule 30(d)(1) should presumptively apply in the absence of a showing of real need for more time (e.g., if an inventor also has a role in the business). The 30(b)(6) depositions of parties in patent litigation are, however, often critical to the case. Typically, these depositions can encompass highly technical and/or detailed information spanning the course of years or even decades. It is often effective to allow 30(b)(6) depositions to continue for more than a single day. However, to prevent runaway 30(b)(6) depositions, the court can also require that each day of 30(b)(6) deposition counts as a separate deposition for purposes of the per-side deposition limit. Alternatively, a limit on the total number of deposition hours also helps avoid disputes over how many "depositions" a 30(b)(6) deposition counts as, when it encompasses more than one topic.

Often, in noticing a 30(b)(6) deposition, a party will seek testimony on its opponent's contentions on issues of infringement and invalidity. Courts split on whether such information can be gathered by deposition or is best left to interrogatory responses. *Compare B & H Mfg., Inc. v. Foster-Forbes Glass Co.*, 143 F.R.D. 664 (N.D. Ind. 1992), with *McCormick-Morgan, Inc. v. Teledyne Indus., Inc.*, 765 F. Supp. 611 (N.D. Cal. 1991). Given that a party's contentions on infringement and invalidity issues are often in flux until after claim construction and expert discovery, objections to depositions on these issues are usually well founded. The better course of action is to address a party's contentions through interrogatory responses while limiting deposition testimony to factual matters underlying a party's contentions.

4.2.6 Protective Orders—Handling of Confidential Documents

As noted in § 2.1.2, most patent cases involve important trade secrets requiring the early entry of a protective order. As we explored there, many districts have developed default protective orders that go into effect immediately upon the filing of a patent case or soon thereafter upon a motion of a party. These rules enable the discovery process to begin promptly.

The default protective orders contained in Appendix 2.2 provide a range of balanced alternatives for protecting trade secrets while enabling discovery to proceed. Most sophisticated parties will typically want to customize the protective order and will generally agree relatively quickly on an order best tailored to their particular circumstances. The expectation that the court will enter a default protective order often facilitates consensus among the parties.

The following sections address common disputes that arise with respect to protective orders: (1) overdesignation of confidential documents, (2) claw-back provisions, and (3) prosecution bars.

4.2.6.1 Overdesignation of Confidential Documents

Disputes can arise over restrictions on access by particular party representatives. For example, one party may wish to have certain technical information available to an employed engineer or scientist and to provide financial data to one of its financial officers. Exercising discretion in these disputes will require the court to weigh several considerations, such as the current sensitivity of the data, the difficulty of detecting any misuse, and the level of direct competition that might be put at risk. In addition, the court may want to consider practical issues such as the number of non-lawyers that are proposed to have access and the administrative challenge of keeping track of who has had access to what information.

On the other hand, parties often overdesignate confidential information—that is, documents that do not require protection are designated as confidential or highly confidential. This sometimes occurs because the producing party faces a significant challenge in reviewing hundreds of thousands of pages of documents not just for privilege but also for making judgment calls on the level of appropriate access. In an effort to be cost-effective and efficient, parties often “block designate” files from a particular source as highly confidential. For example, documents collected from a lead research engineer’s file labeled “Strategy for Development of New XYZ Product” might reasonably be assumed to be of a highly confidential nature and might be block designated as such. Inevitably, however, this will result in some overdesignation, such as for published articles included in the files or e-mails setting up meetings. In such cases, de-designation of specific documents upon reasonable request of the receiving party is the best and simplest solution.

In cases where designation disputes arise, parties should be strongly encouraged to resolve them without court intervention. Requiring a motion to focus on particular documents is one way to prompt parties to reach their own solution. It is the rare

document that absolutely must be provided to an executive of a party's adversary (not just outside counsel) for that executive to make a decision about settlement, and yet would cause irreparable harm to the producing party if its adversary's executive had access to it. If parties are required to justify their positions on a document-by-document basis, one side or the other will often see that the dispute does not warrant court intervention. If the parties persist, referral to a special master or magistrate judge, depending on local practice, may be appropriate. In extreme cases, a party's overzealous confidentiality designations may warrant sanctions. See *In re Violation of Rule 28(d)*, 635 F.3d 1352, 1355–56 (Fed. Cir. 2011) (sanctioning parties, in briefing before the Federal Circuit, for having designated as confidential case citations, legal arguments, and quotations from publicly available opinions; noting public policy of access to court proceedings). The heavy burden of considering motions to seal has led some judges in the Northern District of California to be skeptical of such requests. See, e.g., Order Denying Administrative Motion to File Under Seal, *Innovative Automation LLC v. Kaleidescape, Inc.*, No. 3:13-CV-05651 (N.D. Cal. Oct. 17, 2014); Order Re: Motion to Seal, *Apple Inc. v. Samsung Elecs. Co., Ltd.*, No. 5:11-CV-01846 (N.D. Cal. Nov. 18, 2014).

4.2.6.2 Claw-Back Provisions for Privileged Documents

Another common consequence of the voluminous document discovery in patent litigation is inadvertent production of documents protected by attorney–client privilege and/or work-product doctrine. Such inadvertent production may occur despite diligent efforts by a party to prevent it. For example, large teams of attorneys, including contract attorneys unfamiliar with the actors in a case, may be used to complete document processing quickly. In such cases, a document may be inadvertently produced because the attorney reviewing it did not understand that it was generated by or at the direction of a party's counsel.

Federal Rule of Civil Procedure 26(b)(5)(B) addresses this situation. A party that believes it has unintentionally produced privileged information may give notice to the receiving party, who must then “promptly return, sequester, or destroy the specified information and any copies it has” and “take reasonable steps to retrieve” any information it has already distributed or disclosed to others. Fed. R. Civ. P. 26(b)(5)(B). Until the claim of inadvertent production is resolved, the producing party is required to preserve the information and the receiving party may not use or disclose it.

Courts should consider including in their protective orders a so-called claw-back provision, which provides some procedural structure to the substantive command of Rule 26. Such provisions often require that a receiving party promptly return or destroy, rather than sequester, allegedly inadvertently produced privileged documents. If a receiving party disputes the privileged nature of the document, it may then make a motion to compel its production.

Of course, Rule 26(b)(5)(B) does not change the substantive law that determines whether privilege was waived by the production. See Fed. R. Civ. P. 26(b)(5) (2006 advisory committee notes). The principles by which courts decide questions of inad-

vertent waiver may vary from circuit to circuit. Compare *United States ex. rel. Bagley v. TRW, Inc.*, 204 F.R.D. 170, 177 (C.D. Cal. 2001), with *Helman v. Murry's Steaks, Inc.*, 728 F. Supp. 1099, 1104 (D. Del. 1990). But the Advisory Committee reminds courts that they may include parties' agreements regarding issues of privilege and waiver in an order under Rule 16(b)(6), and that such agreements and orders may be considered when deciding whether a waiver has occurred in a particular instance. Fed. R. Civ. P. 26(b)(5) (2006 advisory committee notes). The factual inquiry underlying the cause of the inadvertent disclosure of privileged material can include the amount of time and circumstances under which the electronic production was reviewed. See, e.g., *First Tech. Capital, Inc. v. JPMorgan Chase Bank, N.A.*, 2013 WL 7800409, 2013 U.S. Dist. LEXIS 185763 (E.D. Ky. Dec. 10, 2013) (finding waiver where counsel's review process employed "essentially no care" in protecting the privileged documents because each document had received only 9.84 seconds of review and had not been tracked using a privilege log).

Another less utilized mechanism, Federal Rule of Evidence 502(d), protects against the waiver of privilege for inadvertently disclosed documents. Although FRE 502(b) provides some protection by considering whether the conduct that resulted in disclosure was "reasonable," a Rule 502(d) claw-back agreement entered as an order of the court can replace the Rule 502(b) "reasonableness" standard and protect from waiver of privilege. See *Great-West Life & Annuity Ins. Co. v. Am. Econ. Ins. Co.*, 2013 WL 5332410, 2013 U.S. Dist. LEXIS 135750 (D. Nev. Sept. 23, 2013) (upholding a Rule 502(d) claw-back agreement).

4.2.6.3 Prosecution Bars

Sometimes a party's litigation counsel also represented—and continues to represent—that party in preparing and prosecuting patent applications in the U.S. Patent and Trademark Office (USPTO). In such cases, a protective order that restricts access to sensitive documents to "litigation counsel" offers faint protection to the other party, whose sensitive information might be used—unintentionally—to the competitor's advantage in prosecuting ongoing patent applications. To address this concern, courts often include in the protective order a "prosecution bar" that prohibits any attorney who has viewed a party's confidential information from preparing or prosecuting patent applications that use or otherwise benefit from the attorney's having viewed the information. Moreover, courts frequently bar any attorney who has viewed a party's confidential information from prosecuting applications that are related to the same technological subject matter of the patent dispute for a period of years. Many courts often extend prosecution bars to cover any person (not only attorneys) to whom highly confidential information is disclosed, which impacts experts as well as attorneys. Section 4.6.9 discusses motion practice relating to prosecution bars.

The Federal Circuit addressed the standard that lower courts should apply in determining when an unacceptable risk of inadvertent disclosure of highly confidential information arises in *In re Deutsche Bank*, 605 F.3d 1373 (Fed. Cir. 2010). The court

drew on the guiding principles of prosecution bars enunciated in *U.S. Steel Corp. v. United States*, 730 F.2d 1465 (Fed. Cir. 1984).

In re Deutsche Bank considered whether a trial counsel who also routinely prosecuted patent applications for his client should be exempted from a prosecution bar. The lower court permitted the lead trial counsel to view highly confidential documents and exempted him from the prosecution bar. The Federal Circuit held that the parties must make specific showings regarding the scope of the bar and any exceptions to be made to the bar. The party seeking imposition of the bar must show a nexus between the scope of the bar and the risk of inadvertent disclosure. The party seeking an exemption from the bar must show on a counsel-by-counsel basis: (1) that counsel's representation of the client in matters before the USPTO does not, and is not, likely to implicate competitive decision making related to the subject matter of the litigation, so as to give rise to a risk of inadvertent use of confidential information learned in litigation, and (2) that the potential injury to the moving party from restrictions imposed on its choice of litigation and prosecution counsel outweighs the potential injury to the opposing party caused by such inadvertent use. *Id.* at 1381.

Several courts refusing to extend prosecution bars to prosecution activities during reexamination proceedings have reasoned that reexamination does not pose the same risks as other types of prosecution because patent claims may only be narrowed during reexamination. *See, e.g., Document Generation Corp. v. Allscripts, LLC*, 2009 WL 1766096, 2009 U.S. Dist. LEXIS 52874 (E.D. Tex. June 23, 2009); *Kenexa Brassring Inc. v. Taleo Corp.*, 2009 WL 393782, U.S. Dist. LEXIS 12002 (D. Del. Feb. 18, 2009). These decisions may not reflect the realities of some reexamination practices. Although patent claims may not be broadened during reexamination proceedings, an attorney with knowledge of a competitor's highly sensitive information can potentially use that information (perhaps inadvertently) to fashion the narrower claims in a way to avoid key prior art while capturing a competitor's product (or future product). Thus, as this example illustrates, reexamination proceedings are not immune from the pitfalls of competitive decision making inherent in patent prosecution. In light of the Federal Circuit's *In re Deutsche Bank* ruling, a more thorough approach for determining whether reexamination activities should be included in a prosecution bar would be to apply the standard set forth by the Federal Circuit for each attorney who might participate in the reexamination activity.

4.2.6.3.1 Prosecution Bars and PTAB Review

The postgrant review procedures introduced by the America Invents Act (AIA), *see* §§ 14.2.5.7–14.2.5.8, have been enthusiastically embraced by many attorneys in the patent bar as an alternative (and in many cases an accompanying action) to patent litigation. *See* § 2.2.6.4. These procedures are seen by some alleged infringers as a favorable alternative to patent litigation because they are significantly less expensive and are required by statute to be completed within a year of institution. From the petitioner's point of view, these procedures are also advantageous because of the lower burden of proof for invalidity and the broader claim-construction standard ("broadest reasonable interpretation") applied in the Patent Trial and Appeal Board

(PTAB) proceeding. Furthermore, as a result of the short time to determination, courts have been more inclined to stay cases in their early phases in light of an instituted inter partes review (IPR) or covered business method (CBM) petition. See § 2.2.6.4. While IPR and CBM procedures permit for certain discovery, it is significantly less than that in district court litigation. The discovery is largely limited to expert examinations, and any additional discovery must be requested and must be “in the interests of justice.” See, e.g., *Garmin Int’l, Inc. v. Cuozzo Techs. LLC*, Case IPR2012-00001, 2013 Pat. App. LEXIS 2445, 2013 WL 2023626, at *5 (P.T.A.B. Mar. 5, 2013) (denying a motion for additional discovery, listing as relevant factors that the requested discovery must: (1) rise above more than a possibility and mere allegation of something useful, (2) is clear and understandable, (3) is not overly burdensome, (4) cannot be equivalently obtained by other means, and (5) is not directed to the opposing party’s litigation positions and bases for their positions).

Claim amendment during IPR is also markedly different than amendment during regular prosecution or ex parte reexamination practice. First, common claim amendment practices permitted in ex parte prosecution, such as automatic claim amendment and ability to broaden claims, are not permitted in IPR proceedings. Additionally, the patent owner bears the burden of showing that any proposed new or amended claims are patentable. See *Idle Free Sys., Inc. v. Bergstrom Inc.*, IPR 2012-00027, Paper No. 66 (P.T.A.B. Jan. 7, 2014) (reasoning that the IPR is an adjudicative rather than an examining proceeding, and the board does not “examine” patent claims in the same way as a patent examiner does during patent prosecution). These limitations likely explain why most proposed amendments have not been accepted by the PTAB panels. The PTAB’s opinion in *International Flavors & Fragrances, Inc. v. U.S. Agriculture*, IPR2013-00124 (P.T.A.B. May 20, 2014), marked the first time it had granted a motion to amend since the enactment of the AIA, although the USPTO has indicated that it intended to liberalize its amendment practice. Michelle K. Lee, *Director’s Forum: PTAB’s Quick-Fixes for AIA Rules Are to Be Implemented Immediately*, USPTO Director’s Forum (Mar. 27, 2015, 10:18 AM), http://www.uspto.gov/blog/director/entry/ptab_s_quick_fixes_for.

As a result of the differences between IPR practice and the former reexamination practice, courts have been less likely to bar attorneys who have had access to designated material from participating in PTAB proceedings. See, e.g., *Endo Pharm. Inc. v. Actavis Inc.*, 2014 U.S. Dist. LEXIS 112642, 2014 WL 3950900 (S.D.N.Y. Aug. 13, 2014); see also Oral Order, *M/A-COM Tech. Solutions Holdings Inc. v. Laird Techs. Inc.*, C.A. No. 14-181-LPS (D. Del. July 31, 2014). That could change if the PTAB substantially loosens its rules regarding claim amendments during postgrant review proceedings.

4.2.7 Foreign Discovery Issues

It is becoming increasingly common for foreign discovery issues to arise in patent litigation. In part this is because of globalization—not only manufacturing but also research and development are now increasingly performed abroad—and in part this is because the American patent system is perceived to offer advantages that oth-

er jurisdictions do not, including strong protection for intellectual property and the availability of broad discovery. Foreign patentees may prefer resolving intellectual property disputes in the United States, even when the dispute is with a foreign defendant. They may believe they can get more effective relief in the United States due to the large size of the American market as well as the perceived strength of available remedies.

Of course, when a foreign entity is a party to the litigation, discovery may be had through Federal Rules of Civil Procedure 33–36, just as with any other party. But frequently the party will be a subsidiary of a foreign entity that is not a party, perhaps because of jurisdictional issues. The issue then arises of whether the documents, information, and witnesses of the foreign parent are within the “possession, custody, and control” of the subsidiary. Under the “control” prong, courts may find that documents in the possession of a foreign parent, subsidiary, or affiliate company are in the “control” of the party. For example, a party has been found to “control” the documents at issue when it can ordinarily obtain them in the usual course of its business from the foreign entity. *See, e.g., Alcan Int’l Ltd. v. S.A. Day Mfg. Co., Inc.*, 176 F.R.D. 75, 79 (W.D.N.Y. 1996); *Afros S.P.A. v. Krauss-Maffei Corp.*, 113 F.R.D. 127, 129–32 (D. Del. 1986).

If a foreign entity is not a party, discovery may still be sought through a letter rogatory, or a letter of request to a foreign or international tribunal, under 28 U.S.C. § 1781. International treaties, such as the Hague Convention on Taking of Evidence Abroad in Civil or Commercial Matters, or the Inter-American Convention on Letters Rogatory, provide a procedure whereby the district court can request the assistance of a foreign tribunal. Not every country is a treaty signatory, and many signatory countries have taken advantage of the ability to “opt out” of requirements to provide certain types of discovery. Article 23 of the Hague Convention permits signatory countries to make a declaration or a reservation that they “will not execute Letters of Request issued for the purpose of obtaining pre-trial discovery of documents as known in Common Law countries.”

The Federal Rules and treaties such as the Hague Convention are not mutually exclusive, but courts should be mindful of principles of international comity and take a supervisory role in foreign discovery disputes. *See Société Nationale Industrielle Aerospatiale v. United States Dist. Ct.*, 482 U.S. 522, 546 (1987). Some countries (e.g., the United Kingdom, Canada, and France) have enacted “blocking” statutes, which prohibit compliance with foreign discovery orders for the production of evidence located within the blocking state’s territory. Blocking statutes often include a penal sanction for violations. Nevertheless, “[i]t is well settled that [foreign “blocking”] statutes do not deprive an American court of the power to order a party subject to its jurisdiction to produce evidence even though the act of production may violate that statute.” *Id.* at 544 n.29. Accordingly, in considering whether to compel discovery, courts must balance a variety of factors, including whether compliance with the request would undermine important interests of the state where the information is located. *Id.* at 544 n.28.

4.3 Claim Construction and Discovery

Since claim construction is considered an issue of law and is focused on the fixed, textual language of the patent in suit, one might reasonably ask what discovery can possibly have to do with it. There are two principal answers. First, as the Supreme Court pointed out in the *Markman* decision, claim construction mixes law with fact, the latter consisting of the perspective of one of ordinary skill in the art. To decide how such a person would view the claims in light of the intrinsic evidence, the court has to determine the point of view of that person. Discovery can aid in that process. For example, depositions of inventors—whose views on what claim terms mean are of attenuated relevance—may be quite helpful to the process of claim construction by illuminating relevant aspects of the prosecution history or by describing the technology or the state of the art. *Voice Techs. Grp., Inc. v. VMC Sys., Inc.*, 164 F.3d 605, 615 (Fed. Cir. 1999).

Second, discovery can reveal the parties' contentions regarding infringement and validity, informing the choice of claim terms requiring construction. This is important as a practical matter, since many patents contain dozens of claims with hundreds of words or phrases that could potentially be candidates for interpretation. By allowing the parties to conduct sufficient discovery to understand what products are accused of infringement (and why) and what prior art might be asserted against the patent, the court can effectively reduce the number of disputed claim terms that would otherwise be presented for interpretation.

In light of the special utility of this early discovery, courts might consider allowing the parties to phase their discovery efforts—for example, by allowing the defendant to take a preliminary deposition of the inventor in aid of claim construction, reserving additional time for other issues.

4.4 Electronic Discovery

A significant portion of discovery in patent litigation is electronic discovery. Although electronic discovery in patent litigation presents similar issues as electronic discovery in other complex litigation, certain unique challenges arise more frequently in patent cases.

4.4.1 Overview of Electronic Discovery

In 2006, the Federal Rules of Civil Procedure were amended to provide rules for discovery of electronically stored information (ESI). These amendments modified Rules 16, 26, 33, 34, 37, and 45 in an effort to clarify the law on electronic discovery. Although a complete analysis of all the rules relating to electronic discovery is beyond the scope of this section, it is beneficial to review some of the major features of electronic discovery.

The Federal Rules require consideration of electronic discovery at the beginning of a case. Pursuant to Federal Rule of Civil Procedure 26(f)(2), the parties must “discuss any issues about preserving discoverable information; and develop a proposed

discovery plan.” The discovery plan produced under Rule 26 must address “any issues about disclosure or discovery of electronically stored information, including the form or forms in which it should be produced.” Fed. R. Civ. P. 26(f)(3)(C). Additionally, each party’s initial disclosures under Rule 26(a) must identify any ESI that it intends to use to support its case.

The nature of ESI is such that some types of documents are more accessible than others. The *Zubulake* decision outlines five categories of discoverable electronic data in order of decreasing accessibility: (1) active, online data, (2) near-line data, (3) off-line storage and archives, (4) backup tapes, and (5) erased, fragmented, or damaged data. *Zubulake v. UBS Warburg, LLC*, 217 F.R.D. 309 (S.D.N.Y. 2003). Inasmuch as the last two categories contain “inaccessible” data, classification of data can be important in cost-shifting analysis. Under the Federal Rules, ESI is presumptively not discoverable if it comes from a source that is “not reasonably accessible because of undue burden or cost.” To raise the presumption, the responding party to a discovery request must identify the sources that are “not reasonably accessible” that it will not search or produce. In response, the requesting party may challenge the designation by moving to compel, whereupon the burden shifts to the responding party to show that the information is not reasonably accessible. The court may then hold that the information is not reasonably accessible and so is presumptively not discoverable. Even if the requesting party shows “good cause” to obtain production, the court may specify conditions on the production, such as cost-shifting.

The Seventh Circuit has adopted a pilot program for electronic discovery that, among other things, provides greater specificity on what categories of ESI are discoverable. Under this program, “deleted,” “slack,” “fragmented,” and “unallocated” data on hard drives, random access memory (RAM), online access data, and data in metadata fields that are frequently updated automatically is generally deemed not accessible. Additionally, other forms of ESI whose preservation requires extraordinary affirmative measures that are not utilized in the ordinary course of business are not accessible. See *Discovery Pilot: Seventh Circuit Electronic Discovery Pilot Program*, available at <http://www.discoverypilot.com/>.

The International Trade Commission (ITC) also recently adopted amendments to its rules of procedure (19 C.F.R. § 210.27 (2014)) to “reduce expensive, inefficient, unjustified, or unnecessary discovery practices.” The amendments allow a party to object to an e-discovery request when the requested data is “not reasonably accessible because of undue burden or cost” and give discretion to administrative law judges to limit duplicative or unduly expensive discovery.

Spoliation is more complicated in the context of electronic discovery. Freezing corporate documents in the electronic age is difficult, if not impossible, and documents are often destroyed automatically by computer systems rather than at the instruction of a human being. Computer data is in an almost constant state of fluctuation, being altered, overwritten, and otherwise changed. Attempting to arrest this process could prove disastrous for many systems and/or result in enormous costs to the preserving party. Recognizing this fact, Rule 37 states that “Absent exceptional circumstances, a court may not impose sanctions under these rules on a party for failing to provide electronically stored information lost as a result of the routine,

good-faith operation of an electronic information system.” This provision, while providing a safe harbor, does require good faith on the part of litigants. Thus, routine operations of data deletion may not be coopted to intentionally deprive the opposing party of documents believed to be relevant to the litigation and, in some circumstances, may need to be suspended during the litigation. The amendments to Federal Rule of Civil Procedure 37(e), which became effective on December 1, 2015, alter this standard. The amended rule authorizes sanctions for failures to preserve information if they caused substantial prejudice in the litigation and were a result of “willful or bad faith” conduct, or if they “irreparably deprived” a party of a “meaningful” ability to present or defend against claims in the litigation.

Furthermore, sanctions for spoliation in the context of electronic discovery are fraught with uncertainty. Indeed, although in theory the duty to preserve evidence begins when litigation is “pending or reasonably foreseeable,” in practice the standard is not so uniform, nor is there a uniform standard governing the scope of that duty, what conduct justifies sanctions, or the nature and severity of appropriate sanctions. In *Victor Stanley, Inc. v. Creative Pipe, Inc.*, 269 F.R.D. 497, 542 (D. Md. 2010), the court provided a comprehensive table showing how each circuit handles these questions. *Id.* at 542. A copy of this table is included as Appendix 4.1.

4.4.2 Electronic Discovery in Patent Cases

In principle, patent cases present the same electronic discovery issues as do other types of litigation. Document requests in patent cases typically call for enormous and costly exchanges of documents. This is not different from antitrust or employment discrimination litigation. But in practice, some factual situations in patent cases pose distinctive challenges.

First, in a patent case, relevant documents can often be much older than they are in other cases. Damages for past infringement can be sought even after a patent has expired—in such a case, documentation of the invention’s conception and reduction to practice can be more than twenty years old. Determination of a reasonable royalty is done at the time of first infringement, which likewise can reach back more than six years. Thus, patent discovery is directed to a potentially larger and older set of documents, which can dramatically increase the complexity and costs.

Second, because they are often technology companies, parties in patent cases tend to have adopted new communication techniques earlier than others. As a result, they can have a greater percentage of critical records that are electronic instead of paper. Moreover, because technology companies tend to have begun using electronic communication programs earlier than others, the communication programs of parties in patent cases have been through more product cycles on average, resulting in more documents being lost or inaccessible. In general, the corporate e-mail systems that were used in the mid-1990s are no longer in use, and resurrecting those systems to recover data can be prohibitively expensive. And an inventor’s computer may have been replaced or upgraded several times, losing some information each time.

Third, patent cases tend to involve a much higher burden of discovery than other cases. Patent cases typically involve high stakes, with companies risking entire

product lines or the company itself. Discovery for patent cases can implicate the entire operations of companies, including design, manufacturing, marketing, sales, and more. Thus, the cost to comply with discovery requests can be quite high. This is especially salient in cases where patent holding companies that make no products (“nonpracticing entities”) bring suit against companies making an allegedly infringing product. In these cases, the heavy burden of discovery is borne almost exclusively by the defendant, and this asymmetry allows the plaintiff to use discovery as a tool to coerce a favorable settlement.

Because of the high costs and unique burdens of e-discovery in patent cases, the Federal Circuit Advisory Council convened an e-discovery committee. In November 2011, the council adopted the committee’s recommended *Model Order Regarding e-Discovery in Patent Cases*, reproduced here at Appendix 4.2. The order attempts to streamline e-discovery and provides for a tiered approach under which parties exchange core documentation regarding the at-issue technology before producing any e-mails. Further, the model order limits e-mail-production requests to five custodians and five search terms. Litigants around the country have often proposed the order to district courts. In March 2012, the Eastern District of Texas promulgated a model e-discovery order that sets guidelines for the collection and production of electronic data in patent cases and, for example, limits production of e-mail to eight custodians per party based on fifteen search terms per custodian, absent a court order. See E.D. Tex. Local Rules, Appendix P. Other district courts have also promulgated their own model e-discovery orders, such as the Western District of New York’s “Model Order Regarding e-Discovery in Patent Cases,” the District of Delaware’s “Default Standard for Discovery, Including Discovery of Electronically Stored Information (ESI),” and the Northern District of California’s “Guidelines for the Discovery of Electronically Stored Information” (available in Appendix 4.3). The Northern District of California’s guidelines encourage the parties to meet at the beginning of the case to discuss the preservation, search, and production of electronically stored information. The District of Delaware’s standard promulgates particular timing requirements for e-discovery, formats for producing data, and custodian limitations. In line with these developments, the Federal Judicial Center also added a new section on civil case management (including how to address e-discovery issues) in its sixth edition of the *Benchbook for U.S. District Court Judges* (Federal Judicial Center, 6th ed. 2013). Given the current attention to reducing the cost and complexity of electronic discovery in patent cases, it is likely that other districts will promulgate similar standards for cabining electronic discovery in the years to come.

Although there is much wisdom in this effort to reduce the costs of e-discovery, there is no one-size-fits-all solution, and greater experience in managing the scope of electronic discovery will likely result in further evolution and explication of the various guidelines. For example, in many cases, the most expensive ESI to collect is not e-mail, which is often stored on relatively accessible central servers, but the rather contents of the computer hard drives of individual users, which must be copied or “imaged” one by one to collect and produce the users’ working documents. Parties could look to their Federal Rule of Civil Procedure 26(a) initial disclosures to determine whose computers should be imaged. As another example, courts are likely to

face situations in which a witness whose electronic documents were not gathered for a party's production (i.e., the witness was not one of the designated custodians) is called by that party to testify at trial. Courts can adopt a general rule, for example, requiring that the witness's documents be produced in every case (as the Eastern District of Texas requires), or address the situation when it arises to allow for a response tailored to the particular circumstances. Either way, courts will have to balance the equities carefully to ensure that parties have a fair opportunity to obtain discovery, but also that the exceptions to e-discovery management do not swallow the rule.

As technology improves, new search techniques based on a document's relationship to other documents (such as having senders or recipients in common, being close in time, being stored in the same location, and the like) are beginning to supplant "search terms" that only select documents based on the presence of particular key words in a document. However e-discovery is done, parties can be encouraged to work together to test their searches to ensure that they are likely to discover relevant information. This can involve an iterative meet-and-confer process between the parties, whereby the party seeking documents proposes a set of search terms, which are then tested by the producing party to determine whether the terms result in an unwieldy number of documents being produced, such that the terms should be renegotiated.

Parties can also turn to the court to resolve these issues. District courts have provided specific guidance on the search methods and terms that parties use during discovery. Some courts have compelled parties to disclose the search terms and custodians they use to find responsive documents. Some courts have ruled on the actual search terms that parties should use, while other courts order the parties to reach a compromise on their own. Courts are also beginning to discuss the issue of whether predictive coding (automated review of electronic documents through linguistic analysis) may appropriately replace manual review and keyword searches. The first federal case permitting computer-assisted review of ESI by predictive coding is *Da Silva Moore v. Publicis Groupe*, 287 F.R.D. 182, 184 n.2 (S.D.N.Y. 2012). The *Da Silva Moore* court permitted the use of predictive coding after considering the amount of material at issue (over three million documents), the superiority of computer-assisted review in that case, and the fact that the parties agreed to computer-assisted review. Another court allowed a party to employ predictive coding to review over two million documents originally reviewed through the use of search terms. See *Bridgestone Ams., Inc. v. Int'l Bus. Machs. Corp.*, No. 3:13-1196, 2014 U.S. Dist. LEXIS 142525, 2014 WL 4923014 (M.D. Tenn. July 22, 2014). Ultimately, because courts generally depend on the parties for the information needed to decide e-discovery-related disputes, courts must impress upon the parties and their counsel the need to educate themselves about their electronically stored information, so that they can effectively carry out their obligations under Federal Rule of Civil Procedure 26(f)(3)(C), resolve issues without judicial intervention to the greatest extent possible, and be prepared to provide the necessary context for the court to decide any contested issues.

4.4.2.1 Spoliation in Patent Cases

Given the broad potential scope of electronic discovery in patent cases, spoliation issues—or at least accusations—often arise. Parties may find it difficult to understand what documents they have; few have a central repository where all records, especially the oldest, may be found. It can be difficult for a party to produce “all” documents responsive to a discovery request. Increasingly, problems in electronic document production lead to spoliation motions by the party seeking discovery. A thorough understanding of the litigants’ technological challenges is key to determining whether spoliation has occurred. The absence of certain documents from a production may be the result of document destruction policies carried out in good faith, poor document collection practices, or intentional spoliation—the results all look the same at first glance. For example, there is a difference, of course, between searching diligently for electronic records and not finding those that no longer exist, and searching only the most immediately accessible locations and ignoring the rest.

The amendments to Federal Rule of Civil Procedure 37(e), which became effective on December 1, 2015, authorize sanctions for failures to preserve information if these failures caused substantial prejudice in the litigation and were a result of “willful or bad faith” conduct, or if the failures to preserve “irreparably deprived” a party of a “meaningful” ability to present or defend against claims in the litigation.

Spoliation turns on the duty to preserve records. “A party can only be sanctioned for destroying evidence if it had a duty to preserve it.” *Zubulake v. UBS Warburg LLC*, 220 F.R.D. 212, 216 (S.D.N.Y. 2003). The duty to preserve evidence begins when litigation is “pending or reasonably foreseeable.” *Silvestri v. Gen. Motors Corp.*, 271 F.3d 583, 590 (4th Cir. 2001). The Federal Circuit held in *Micron Tech., Inc. v. Rambus Inc.*, 645 F.3d 1311 (Fed. Cir. 2011) that Rambus engaged in spoliation of evidence because it continued to destroy documents after litigation became “reasonably foreseeable.” *Id.* at 1320–26. The court observed that “[w]hen litigation is ‘reasonably foreseeable’ is a flexible fact-specific standard that allows a district court to exercise the discretion necessary to confront the myriad factual situations inherent in the spoliation inquiry. *Fujitsu Ltd. v. Fed. Express Corp.*, 247 F.3d 423, 436 (2d Cir. 2001). This standard does not trigger the duty to preserve documents from the mere existence of a potential claim or the distant possibility of litigation. *See, e.g., Trask-Morton v. Motel 6 Operating L.P.*, 534 F.3d 672, 681–82 (7th Cir. 2008). However, it is not so inflexible as to require that litigation be ‘imminent, or probable without significant contingencies . . .’” *Id.* at 1320; *see also Hynix Semiconductor Inc. v. Rambus Inc.*, 645 F.3d 1336 (Fed. Cir. 2011).

After the duty to preserve is triggered, prejudice occurs when a spoliating party intentionally destroys evidence, although the destruction might not be prejudicial if the evidence is not relevant or is cumulative to other, surviving evidence. *See Sekisui Am. Corp. v. Hart*, No. 12 Civ. 3479 (SAS) (FM), 2013 WL 4116322 (S.D.N.Y. Aug. 15, 2013). One consideration is whether counsel for the litigant adequately and reasonably consulted with their client about the preservation of ESI. One court imposed sanctions on a party’s counsel who did not “examine critically” the client’s representations about document availability and instead assumed that a third-party service provider would preserve the data. *See Brown v. Tellermate Holdings*, No. 2:11-cv-

1122, 2014 U.S. Dist. LEXIS 90123, 2014 WL 2987051 (S.D. Ohio July 1, 2014). In *Procaps S.A. v. Patheon, Inc.*, No. 12-24356-CIV, 2014 U.S. Dist. LEXIS 35225, 2014 WL 1047748 (S.D. Fla. Mar. 18, 2014), the court found ESI searches inadequate because counsel did not meet with IT or ESI personnel or other relevant individuals to discuss document collection and did not assist custodians in the document collection process. On the other hand, automatically deleting e-mails per a routine company deletion policy does not necessarily rise to the level of spoliation. See *In re Pradaxa (Dabigatran Etexilate) Prods. Liab. Litig.*, MDL No. 2385, 3:12-md-02385-DRH-SCW, 2013 U.S. Dist. LEXIS 137235, 2013 WL 5377164 (S.D. Ill. Sept. 25, 2013); *AMC Tech., LLC v. Cisco Sys., Inc.*, No. 11-3403 PSG, 2013 U.S. Dist. LEXIS 101372, 2013 WL 3733390 (N.D. Cal. July 15, 2013).

4.4.3 Issues with Specific File Types in Electronic Discovery

Disputes can arise regarding the decipherability of electronic files. Some file types may be proprietary to one party or require a program that the other party does not have (e.g., source code or semiconductor schematics). Although Rule 34(b) requires that documents be produced in a “reasonably usable form,” there is little guidance as to what satisfies this requirement. Under the Seventh Circuit Pilot e-Discovery Program, discussed in § 4.4.1, the parties must make a good-faith effort to agree on a production format at the Rule 26(f) conference. If they are unable to resolve a production-format issue, that issue should be raised before the court. Under this program, the requesting party is responsible for the incremental cost of creating its copy of the requested information, and the parties are encouraged to discuss cost sharing for optical character recognition (OCR) or other upgrades of non-text-searchable electronic images. The Seventh Circuit program thus conforms to the existing case law that requires balancing the need of one party for the data in its requested form versus the hardship to the other to produce it. See, e.g., *Zubulake v. UBS Warburg LLC*, 217 F.R.D. 309 (S.D.N.Y. 2003).

The District of Delaware has also adopted default standards for handling electronic discovery. See *Default Standard for Discovery, Including Discovery of Electronically Stored Information (“ESI”)*, District of Delaware, available at <http://www.ded.uscourts.gov/sites/default/files/Chambers/SLR/Misc/EDiscov.pdf> (reprinted in Appendix 4.3). Like the Seventh Circuit program, Delaware’s standard includes a Rule 26(f) conference. *Id.* At the conference, the parties must discuss “issues, claims and defenses . . . that define the scope of discovery,” “technical information,” and “the categories of ESI that should be preserved.” *Id.* The Delaware standard also provides that parties produce ESI and non-ESI as “text searchable image files (e.g., PDF or TIFF),” but must produce in native (or original) file format any “files not easily converted to image format, such as Excel and Access files.” In either case, parties must preserve the integrity of the underlying ESI (i.e., its formatting and metadata).

Source code is computer program information in a format that humans can read (before the code is “compiled” into a format a computer can read), and it poses unique discovery challenges. A thorough discussion of electronically stored infor-

mation in many patent cases should address conditions for the production of source code. Given the highly sensitive nature of source code and the lengths to which companies go to protect it during the normal course of business, parties commonly negotiate a more restrained production of source code than for other highly confidential documents. An example of additional security measures that may be appropriate for the production of source code is producing source code on a standalone (non-networked computer) for review in a secure facility. See *SKF Condition Monitoring, Inc. v. Invensys Sys. Inc.*, 07-CV-1116 BTM (NLS), 2010 U.S. Dist. LEXIS 35130, 2010 WL 3463686 (S.D. Cal. Apr. 9, 2010); *Leader Techs. Inc. v. Facebook Inc.*, Civ. No. 08-862-JJF-LPS, 2009 WL 3021168, 2009 U.S. Dist. LEXIS 93807 (D. Del. Sept. 4, 2009); District of Delaware, *Default Standard for Access to Source Code*, available at <http://www.ded.uscourts.gov/sites/default/files/Chambers/SLR/Misc/DefStdAccess.pdf> (last visited Apr. 27, 2015) (available in Appendix 2.4). For example, the District of Delaware's *Default Standard for Access to Source Code*, which applies absent agreement of the parties, provides for the production of source code on a stand-alone computer to which two outside counsel and two experts may have access.

The proliferation of mobile electronic devices and cloud-storage capability has expanded the discovery domain. Recent decisions highlight the importance of preserving dynamic forms of evidence, including those stored on mobile devices (e.g., text messages and mobile device data), social media networks, and cloud-computing platforms. In one case, a court-appointed electronic discovery special master recommended sanctions against a defendant who had systematically destroyed ESI, including text messages and other mobile data. See *Small v. Univ. Med. Ctr. of S. Nevada*, Case No. 2:13-cv-00298-APG-PAL, 2014 WL 4079507, 2014 U.S. Dist. LEXIS 114406 (D. Nev. Aug. 18, 2014). Similarly, in another case, a U.S. magistrate judge imposed sanctions on defendants for their unwillingness and inability to produce information stored on cloud-computing platforms. *Brown v. Tellermate*, 2014 U.S. Dist. LEXIS 90123, 2014 WL 2987051. In *Barrette Outdoor Living v. Michigan Resin Representatives, LLC*, No. 11-13335, 2013 U.S. Dist. LEXIS 60309, 2013 WL 1800356 (E.D. Mich. Apr. 29, 2013), the court sanctioned one of the plaintiff's former employees who had disposed of his mobile phone. These decisions show that courts are becoming increasingly sensitive to the need for preserving electronic data in a variety of forms and media.

The new federal rules dealing with ESI guide courts and parties in dealing with costly electronic discovery issues in patent cases. Several courts provide more specific guidance in the form of default orders. See, e.g., District of Delaware *Default Standard for Discovery, Including Discovery of Electronically Stored Information ("ESI")*, available at <http://www.ded.uscourts.gov/sites/default/files/Chambers/SLR/Misc/EDiscov.pdf>; District of Kansas, *Guidelines for Cases Involving Electronically Stored Information [ESI]*, available at <http://www.ksd.uscourts.gov/guidelines-for-esi/> (both reprinted in Appendix 4.3). In practice, default orders tend to encourage parties to agree to any necessary, case-specific electronic discovery procedures. The Sedona Conference is also a good resource, providing electronic discovery principles courts and litigants have relied upon. See The Sedona Conference, Publications,

available at <http://www.thesedonaconference.org/publications> (last visited May 5, 2016).

4.5 Management of Discovery Disputes

Given the high stakes of patent litigation, lawyers frequently get mired in contentious discovery battles. Effective case management requires that the court discourage this tendency, reserving intervention only for those disputes that matter and that remain unresolved after good faith negotiations between the parties. One way to accomplish this objective is to encourage self-regulation by keeping calendar dates firm so as to avoid the kind of foot-dragging that can occur if extensions of time are easily available. Many judges issue special warnings to counsel in patent cases, threatening to call in principals of the parties if discovery becomes too contentious. Some courts set a presumptive limit on the number of discovery motions that will be heard (e.g., three), after which a discovery special master will be appointed. An increasingly common procedure requires the parties to submit a letter (not to exceed two to four pages) in advance of a telephone conference, asking for permission to file a motion; typically the issues are resolved on the conference call.

Courts can also streamline discovery disputes through speedier and more efficient case-management procedures. In 2014, the Eastern District of Texas created a second set of case-management procedures for patent cases (“Track B”) that can be enforced through party agreement or applied *sua sponte* by the court. Track B provides for a quicker schedule, earlier disclosure of infringement contentions, licenses, and settlement agreements, immediate limited discovery, and an early, good-faith damages estimate. Along the same lines, some judges in the Southern District of New York are imposing case-management orders that expedite the docket by, for example, requiring discovery to be completed within 120 days of the initial pretrial conference and expert discovery to be completed twenty-five days following fact discovery. *See, e.g.*, Hon. Vernon Broderick, Case Management Plan and Scheduling Order §§ 7, 12, available at http://www.nysd.uscourts.gov/cases/show.php?db=judge_info&id=982; Hon. Valerie Caproni, Civil Case Management Plan and Scheduling Order § 5(a), available at http://www.nysd.uscourts.gov/cases/show.php?db=judge_info&id=1035; Hon. Katherine Forrest, Scheduling Order, available at http://www.nysd.uscourts.gov/cases/show.php?db=judge_info&id=980 (fact discovery to close within 120 days of initial pretrial conference, expert discovery complete within twenty-five days of close of fact discovery); Hon. Jed Rakoff, Individual Rules of Practice § 3(b), available at http://www.nysd.uscourts.gov/cases/show.php?db=judge_info&id=832 (“At the initial conference, the Court will issue a binding Case Management Order that, in most cases, will require the case to be ready for trial within five months of the date thereof.”).

In general, courts should emphasize to counsel the importance of the meet-and-confer process. If necessary, courts can order additional procedural requirements to help adversaries keep lines of communication open. For example, courts can require that parties schedule regular teleconferences (e.g., every two weeks) during fact discovery to discuss and resolve accumulated discovery issues. Courts can require in-

person meetings where necessary, followed by the submission of a joint letter brief presenting the dispute to the court. Some courts have required an in-person meet-and-confer between lead trial counsel. An onerous requirement, however, risks abuse by litigants who refuse to provide any discovery until the requirement is satisfied.

The most important consideration is that counsel must meet and confer in good faith, and not just as a perfunctory matter. One recurring problem arises when a party is overly demanding and refuses to compromise during the meet-and-confer process. At least one court quashed a subpoena when a party refused to accept a reasonable offer during the meet-and-confer, but then later tried to accept it. *See Boston Sci. Corp. v. Lee*, No. 5-14-mc-80188-BLF-PSG, 2014 U.S. Dist. LEXIS 107584, 2014 WL 3851157 (N.D. Cal. Aug. 4, 2014). The court reasoned that to allow the party to resume a fallback position it had rejected during the meet-and-confer process “would make a mockery of both parties’ obligation to meet and confer in good faith from the start. The time to tap flexibility and creativity is during meet and confer, not after.” *Id.* Where the court deems it necessary to impose sanctions, experience shows that progressive penalties (from mild to severe, including issue and evidence preclusion or default) are effective at controlling discovery abuses in patent cases.

Referrals of discovery management to magistrate judges are commonplace in many courts and districts. The advantage of referring discovery issues is that it frees the district judge for other work, while keeping responsibility for discovery helps the district judge remain aware of the case and coordinate discovery and scheduling issues. Moreover, there is a certain *in terrorem* effect at work when the district court hears discovery disputes. Litigants may be less likely to raise as many disputes and will likely be more conciliatory if the judge deciding the case has a greater opportunity to assess whether counsel are being unreasonable. Where referral is the common practice, experienced counsel soon learn the tendencies of the magistrate judges on particular issues, resulting in fewer motions. If this doesn’t happen, or if the case otherwise appears likely to generate a disproportionate level of discovery controversy, courts can require the parties to engage a special master under Rule 53. When the special master possesses substantial experience with patent litigation, the resulting process, although sometimes costly, can be substantially more efficient and effective.

4.6 Common Discovery Motions

What follows is a list of the most common discovery motions that raise patent-specific issues, with recommended approaches.

4.6.1 Discovery Regarding Patentee’s Prefiling Investigation

The accused infringer may challenge the basis for the patentee’s having filed suit. Normally this would happen in the context of a Rule 11 motion. The Federal Circuit has laid out guidelines for patent cases describing a minimum investigation, including preparation of a claim chart that matches elements of the patent claims to the accused product. *See Antonious v. Spalding & Evenflo Cos., Inc.*, 275 F.3d 1066,

1073–74 (Fed. Cir. 2002); *View Eng'g, Inc. v. Robotic Vision Sys., Inc.*, 208 F.3d 981, 986 (Fed. Cir. 2000). Generally speaking, the requirements for a prefiling investigation are much more stringent than the Rule 8 notice-pleading standard. See *McZeal v. Sprint Nextel Corp.*, 501 F.3d 1354, 1356–57 (Fed. Cir. 2007); see also *id.* at 1359–60 (Dyk, J., dissenting in part). The patentee may submit its records of investigation for *in camera* review to meet the challenge while still preserving work-product protection. See, e.g., *Centillion Data Sys., LLC v. Convergys Corp.*, No. 104CV0073LJM-WTL, 2006 WL 20777, 2006 U.S. Dist. LEXIS 846, at *3 n.1 (S.D. Ind. Jan. 4, 2006); see also Fed. R. Civ. P. 11 advisory committee notes (1983 Amendment).

The issue occasionally arises outside of the Rule 11 context, where a dispute over infringement contentions, for example, leads a defendant to request discovery of the patentee's prefiling investigation. In the absence of a waiver, the best practice is to deny such discovery. However, the patentee should be required early in the proceeding, either through traditional contention discovery or as a result of patent local rules, to describe its infringement position, without revealing what it did to analyze the accused product before filing. See, e.g., *O2 Micro Int'l, Ltd. v. Monolithic Power Sys., Inc.*, 467 F.3d 1355, 1365–66 (Fed. Cir. 2006); *Nova Measuring Instruments Ltd. v. Nanometrics, Inc.*, 417 F. Supp. 2d 1121, 1123 (N.D. Cal. 2006).

4.6.2 Production of Information About Products

The patentee may make an early request for production of the accused product by inspection, samples, or, in the case of software, for example, copies. The defendant can resist on the grounds that the information is a trade secret and that the patentee should already have met its obligations under Rule 11 to investigate and compare the patent claims to the accused product. This position, however, assumes that the product could have been available to the patentee outside of the discovery process. Some products, such as software or processes, cannot reasonably be obtained before filing litigation, and the patentee must rely on indirect evidence such as marketing materials in making its analysis. See, e.g., *Intamin Ltd. v. Magnetar Techs. Corp.*, 483 F.3d 1328, 1338 (Fed. Cir. 2007). In that event, best practice dictates that the product or copies be made available to the patentee in discovery subject to the terms of a protective order to maintain confidentiality.

Each side in patent litigation may seek information about the other's products, including future or "unannounced" products still in development. Information about the accused infringer's future products is relevant for the patentee because it wants protection against future infringement and because pending changes in the accused products can be probative of willfulness. An accused infringer's inquiry into the patentee's products is also legitimate because the use by the patentee of its claimed invention can bear on damages. For example, the patentee may have been required to mark its products in order to obtain damages. This inquiry is also relevant to whether the patentee is entitled to lost profits. Finally, the patentee's use of its invention can evidence whether the patented invention enjoys or lacks commercial success, which is relevant to nonobviousness and can be relevant to reasonable royalty damages. As with early production relating to the accused product, the best ap-

proach is to allow discovery, subject to orders that maintain security of the confidential data.

4.6.3 Contentions About Infringement, Invalidity, and Unenforceability

In courts without patent local rules, early discovery disputes are likely to focus on contentions, as the accused infringer presses the patentee to articulate its infringement theories while the patentee tries to force the accused infringer to explain its noninfringement and invalidity theories. Indeed, the frequency of such disputes motivated the adoption of patent local rules in many patent-intensive districts. The key to solving this problem lies in understanding the parties' respective burdens and how positions naturally evolve in patent litigation.

As noted in § 4.6.1, patentees are expected to comply with their Rule 11 obligations by carefully comparing the patent claims to the accused product. Therefore, one would assume that any patentee would have a reasonably precise sense of its infringement theory at the outset. However, there are two major issues that can make that expectation unrealistic. First, the patentee might not have been able to get access to the necessary information because it is hidden from view (for example, source code); the product is unavailable (for example, because of tightly controlled distribution); or the target is a process that is only used behind closed doors. In these circumstances, a patentee has to make an educated guess about infringement from the information that is publicly available and rely on early discovery to illuminate the details. Second, because the claim-construction process lies ahead, the patentee will be reluctant to commit to a position that depends on particular interpretations of the claim language.

The defendant is in a comparable situation at the outset of the case since it needs to know what the claims mean before it can have a clear view of why it does not infringe. In the same vein, the defendant's invalidity contentions, in particular defenses like inadequate written description (§ 112(a)), may depend on the outcome of claim construction. Moreover, invalidity contentions relating to §§ 102 and 103 often require time for investigation of the prior art and discovery of the plaintiff's invention and sales records.

Best practice in this environment requires a combination of flexibility (to accommodate the reasonable constraints faced by each party) and pressure (to force movement and expressions of position that can later be refined). Frequently district courts have imposed a process that draws from the experience of patent local rules, setting a schedule for preliminary contentions, followed by a more committed position following issuance of a claim-construction order.

Unenforceability (inequitable conduct) raises a separate, but related, concern. Because this defense basically asserts fraud on the USPTO, the particularity requirements of Rule 9 require that the accused infringer be specific about the underlying basis for the charge. See *Therasense, Inc. v. Becton, Dickinson & Co.*, 649 F.3d 1276 (Fed. Cir. 2011) (en banc). However, as in other kinds of fraud, the detailed facts,

especially those related to materiality and intent, often require substantial discovery before the proponent can be expected to provide a full explanation of the charge.

As noted in §§ 2.6.4, 4.2.2, and 4.2.3, courts should find opportunities to encourage or require parties to disclose their damages contentions and supporting evidence during the fact discovery period. Requiring parties to provide fulsome responses to contention interrogatories concerning damages (and not to simply incorporate by reference expert reports that have not yet been served, as is customary) can prod such disclosures, provided that the responding party has had a meaningful opportunity to take damages-related discovery.

4.6.4 Bifurcation or Stay of Discovery Pending Reexamination of Patent

As described in §§ 2.2.6.4 and 14.2.5.6, anyone can request that the USPTO institute a reexamination proceeding to take a second look at the validity of a patent. Such requests are increasingly common in general and occur more often in the shadow of patent litigation. Often such requests are attended by a motion to the district court to stay discovery or even the entire litigation pending the outcome of the USPTO proceedings. Section 2.2.6.4 explores the general standard for granting a stay of the litigation.

Even when a district court is not inclined to stay the entire litigation, courts are often asked to stay discovery pending reexamination. Where there would be substantial overlap in that discovery with what may still be going on in the case following invalidation of the reexamined claims, it may well be more efficient and equitable to allow some discovery to proceed. A partial stay of discovery in a patent case, however, is difficult to enforce because there are typically no bright-line borders for relevance among different issues in any given case. What may appear as a timesaving hold on some issues may actually result in more time spent resolving disputes over the boundaries of the discovery stay.

4.6.5 Bifurcation or Stay of Discovery Pending Early Dispositive Motion

Sometimes a case presents obvious issues for early termination, and in patent cases this could arise from a jurisdictional challenge (e.g., personal jurisdiction, ownership), *see, e.g., Mullally v. Jones*, No. 2:05CV00154-BES-GWF, 2007 WL 1213704, 2007 U.S. Dist. LEXIS 30283, at *6–7 (D. Nev. Apr. 24, 2007), or from a challenge to infringement that depends entirely on a specific question of claim construction, *see, e.g., Cornell Research Found., Inc. v. Hewlett Packard Co.*, 223 F.R.D. 55, 58 (N.D.N.Y. 2003). In these situations, it may be appropriate to limit discovery to the single issue to enable the parties to prepare a dispositive motion. *See* §§ 6.1.3, 6.1.3.4 (discussing dual-track summary judgment framework). Although some questions may arise about whether specific discovery is within the bounds set by the court, the amount of time necessary to resolve that controversy is generally more than offset by the potential savings through early termination.

4.6.6 Bifurcation or Stay of Discovery on Issues Bifurcated for Trial

District courts sometimes bifurcate issues for trial in patent cases. Most common is a counterclaim for antitrust based on an allegation that the patent complaint is a sham, *see In re Innotron Diagnostics*, 800 F.2d 1077 (Fed. Cir. 1986), the defense of inequitable conduct, *Gardco Mfg., Inc. v. Herst Lighting Co.*, 820 F.2d 1209 (Fed. Cir. 1987), and a plaintiff's assertion of willfulness, *see Medpointe Healthcare, Inc. v. Hi-Tech Pharmacal Co., Inc.*, Civ. Action Nos. 03-5550 (MLC), 04-1686 (MLC), 2007 WL 188285, 2007 U.S. Dist. LEXIS 4652, at *17 (D.N.J. Jan. 22, 2007). We address the risks and potential rewards of this discretionary decision to divide up the trial in § 8.1.1.

Having made or entertained trial bifurcation, courts will also need to consider whether discovery should go forward on the bifurcated issue. Here, unless a primary driver of the decision to bifurcate is to save time and other complications in discovery (as is often true in bifurcating willfulness, for example), often the best practice is to presume that discovery should go forward on all issues. *See, e.g., Ecrix Corp. v. Exabyte Corp.*, 191 F.R.D. 611, 614 (D. Colo. 2000). In this way, the parties will be prepared to proceed immediately with trial on the bifurcated issue if it becomes relevant, the court will be spared the difficulty of drawing lines about what is relevant for discovery, and the parties will be fully informed on all the issues for purposes of settlement discussions. On the other hand, when an essential element of a claim is related to the outcome of another claim in the suit, as in a sham-litigation antitrust counterclaim, it might make more sense to stay the one claim in its entirety (including discovery) until the underlying claim is adjudicated. *See Prof. Real Estate Investors, Inc. v. Columbia Pictures, Inc.*, 508 U.S. 49, 60 (1993) (affirming grant of summary judgment against antitrust counterclaim, though further discovery into anti-competitive intent had been denied by the district court) (holding that “[o]nly if challenged litigation is objectively meritless may a court examine the litigant’s subjective motivation”). After all, a “winning lawsuit is by definition a reasonable effort at petitioning for redress and therefore not a sham.” *Id.* at 60 n.5.

4.6.7 Privilege Waiver Based on Defendant’s Election to Rely on Advice of Counsel

The Federal Circuit’s decision in *In re Seagate Tech. LLC*, 497 F.3d 1360 (Fed. Cir. 2007) (en banc) reduced motion practice regarding privilege waiver scope in holding that disclosing an opinion of counsel to support an advice-of-counsel defense does not extend the waiver to trial counsel. *Id.* at 1372–75. The same rationale applies to the work-product doctrine as well, protecting from discovery the sometimes voluminous and provocative thoughts and strategies of litigation counsel. *Id.* at 1375–76. The Federal Circuit left unanswered the question of what to do when opinion counsel and trial counsel are from the same firm, or even the same person.

4.6.8 Discovery from Patent Prosecution Counsel

A claim of patent infringement by itself does not usually require taking discovery from the lawyer who prosecuted the application. Whatever happened in prosecution is a matter of record, and claim-construction issues are decided based on that “intrinsic” record. *See* § 5.2.2. For example, if the defendant asserts that a statement by the patentee to the USPTO should be considered as a “disclaimer” of claim scope, normally the court would not hear testimony from the patent lawyer to explain what was said or why it was said. Therefore, while inventor testimony is almost always taken during discovery, the same is not true of the patent lawyer.

That is not to say, however, that patent prosecutors are never or even seldom deposed. In some cases, the defense of unenforceability will be asserted based on allegations of inequitable conduct in the procurement of the patent. Most often this consists of a failure to disclose certain prior art, but it can also involve mischaracterization of the art that was submitted or other misstatements made to the USPTO. In those cases, the patent attorney is almost always deposed.

As in other areas of the law, attorney testimony raises issues of work-product protection and privilege. In the patent prosecution context, the general rule is that the attorney–client privilege applies to communications between the inventor and the prosecuting attorney but there is no protection against discovery of communications, whether written or oral, between the patent prosecutor and the USPTO. *See In re Spalding Sports Worldwide, Inc.*, 203 F.3d 800 (Fed. Cir. 2000); *Winbond Elecs. Corp. v. ITC*, 262 F.3d 1363, 1376 (Fed. Cir. 2001). Courts generally find that work performed by an attorney to prepare and prosecute a patent application does not fall within the parameters of the work-product protection because it is usually part of a nonadversarial, ex parte proceeding. *See, e.g., In re Minebea Co.*, 143 F.R.D. 494, 499 (S.D.N.Y. 1992). Accordingly, work done to that end is not usually “in anticipation of” or “concerning” litigation. Discovery disputes in this context often test the application of this rule. *See, e.g., Rowe Int’l Corp. v. Ecast, Inc.*, 241 F.R.D. 296, 300–01 (N.D. Ill. 2007); *Bd. of Trs. of the Leland Stanford Junior Univ. v. Roche Molecular Sys., Inc.*, 237 F.R.D. 618, 623–25 (N.D. Cal. 2006). Indeed, the work-product doctrine can protect work performed to prosecute a patent application if it was *also* performed in anticipation of or concerning litigation. *Minebea*, 143 F.R.D. at 499.

In practice, discovery taken from patent prosecutors may not be very helpful, either because memories have lapsed with the passage of time or the prosecutor purged all nonessential papers (such as drafts) once the patent issued. This file management practice is relatively common, but it is inconsistent with a later assertion of work-product protection. If litigation was anticipated, a patent prosecutor was duty-bound to preserve potential evidence, and nothing should have been discarded.

Occasionally the lawyer who prosecuted the patent application also serves as counsel of record in the litigation. Here, the lawyer’s choice to act as both advocate and witness is necessarily awkward, but the authority that bars taking deposition of trial counsel will usually not apply. *See, e.g., Plymouth Indus., LLC v. Sioux Steel Co.*, No. 8:05CV196, 8:05CV469, 2006 WL 695458, 2006 U.S. Dist. LEXIS 14706, at *14–15 (D. Neb. Mar. 17, 2006); *Genal Strap, Inc. v. Dar*, No. CV2004-1691(SJ)(MDG), 2006 WL 525794, 2006 U.S. Dist. LEXIS 11474, at *6–10 (E.D.N.Y. Mar. 3, 2006);

aaiPharma, Inc. v. Kremers Urban Dev. Co., 361 F. Supp. 2d 770, 774–75 (N.D. Ill. 2005); *Alcon Labs., Inc. v. Pharmacia Corp.*, 225 F. Supp. 2d 340, 344 (S.D.N.Y. 2002); *Amicus Commc'ns, L.P. v. Hewlett-Packard Co.*, No. 99-0284 HHK/DAR, 1999 WL 33117227, 1999 U.S. Dist. LEXIS 20901, at *4–5 (D.D.C. Dec. 3, 1999); *Environ Prods. v. Total Containment, Inc.*, 41 U.S.P.Q.2d (BNA) 1302, at *11–14 (E.D. Pa. Aug. 21, 1996). In general, the prosecutor should receive no special dispensation from discovery merely because of the decision to also act as litigation counsel, but privilege and work-product protections will normally apply to communications made and information developed in the context of litigation rather than prosecution. To resolve such contextual issues, the court may have to examine relevant material in camera. See *Quantum Corp. v. Tandon Corp.*, 940 F.2d 642, 644 (Fed. Cir. 1991). Whether the prosecutor as litigator requires disqualification is a matter of the ethics rules of a particular jurisdiction. See, e.g., *Gen. Elec. Co. v. Industria Prods., Inc.*, 683 F. Supp. 1254, 1258 (N.D. Ind. 1988).

4.6.9 Access to Confidential Information by Patent Prosecution Counsel

In settling on the form of an umbrella protective order, a dispute may arise over whether a party's patent prosecution lawyers may appear as counsel of record in the litigation and, therefore, have access to attorneys-only information. The advantage to the requesting party is easy to understand: its patent attorneys already have experience with the technology and their participation on the litigation team will enhance efficiency. This perceived advantage, as well as the natural deference owed to a party's choice of counsel, must be weighed against the risk that such access might pose to the other side.

Much of the risk arises from the fact that a single patent can spawn a family of later patents on the same subject. These "continuation" applications seek to fashion better claims based on the same original disclosure. Indeed, it is common and acceptable for a patentee to draft later claims that precisely target the products of a competitor. See *Kingsdown Med. Consultants, Ltd. v. Hollister, Inc.*, 863 F.2d 867, 874 (Fed. Cir. 1988). But the fairness of that practice presumes that such claims are drafted based on *public* information. When a patent prosecutor gets access to attorneys-only information in litigation, this can open a door into the details of secret projects and provide an unfair advantage. Because of this concern, some courts have imposed a "prosecution bar" as part of the normal discovery protective order. See §§ 2.1.2, 4.2.5. In its most typical form, the provision bars any lawyer having access to designated information from participating in prosecution of patents in a particular subject during the pendency of the litigation and a year after its termination. If it appears that a prosecution bar is appropriate, the dispute may devolve to the subject-matter restriction, with the proponent of the bar arguing for a broad area, and the resisting party proposing only the particular patent family being prosecuted on behalf of that party. See, e.g., *Cummins-Allison Corp. v. Glory Ltd.*, No. 02 C 7008, 2003 WL 26620151, 2003 U.S. Dist. LEXIS 23653, at *31–33 (N.D. Ill. Dec. 31, 2003).

The decision on whether to impose a prosecution bar, and its conditions, should be informed by such factors as (1) the level of competition and sensitivity of the data, (2) the attorney's role in ongoing prosecution, (3) the size of the attorney's firm and effectiveness of any proposed ethical walls, (4) the availability of other counsel to handle the litigation, and (5) whether the attorney participated in prosecution of the patent in suit and therefore may be called as a witness. *See, e.g., In re Deutsche Bank*, 605 F.3d 1373 (Fed. Cir. 2010) (granting writ of mandamus to vacate a protective order and remanding with instructions to apply the new standard regarding the scope of prosecution bars); *Commissariat a L'Energie Atomique v. Dell Comput. Corp.*, No. Civ.A. 03-484-KAJ, 2004 WL 406351, 2004 U.S. Dist. LEXIS 12782 (D. Del. Mar. 3, 2004); *Motorola, Inc. v. Interdigital Tech. Corp.*, No. Civ.A. 93-488-LON, 1994 WL 16189689, 1994 U.S. Dist. LEXIS 20714 (D. Del. Dec. 19, 1994); *see also U.S. Steel Corp. v. United States*, 730 F.2d 1465, 1468 (Fed. Cir. 1984).

This analysis has been challenging to apply with respect to PTAB proceedings. As discussed in §§ 2.1.2.1.3, 2.2.6.4, and 4.2.5.3, many courts carve PTAB review practice out of the definition of "prosecution" in prosecution bars in protective orders because the PTAB has been reluctant to permit claim amendments during its review proceedings. The liberalization of the PTAB's amendment practices could justify tightening prosecution bars to limit access by counsel involved in PTAB review.

4.6.10 License Agreements and Other Third-Party Confidential Information

Damage calculations in a patent case depend on assessment of a number of factors, including licenses entered into by either party for the relevant technology or for comparable intellectual property. *See* §§ 2.6.6, 14.4.3.2.1.4; *Georgia-Pacific Corp. v. United States Plywood Corp.*, 318 F. Supp. 1116 (S.D.N.Y. 1970). Many of these agreements are confidential and competitively sensitive, sometimes involving rights of third parties. Therefore, a common area of dispute is the discoverability of proprietary license agreements. The resisting party may argue that they are not sufficiently comparable to provide relevant information or that they interfere with obligations of confidentiality to a nonparty. A court's decision should be guided not only by resolving those arguments as factual predicates, but also by the terms of any protective order that might diminish the risk of harm from production. *See, e.g., Rates Tech., Inc. v. Cablevision Sys. Corp.*, No. CV 05-3583 DRH WDW, 2006 WL 1026044, 2006 U.S. Dist. LEXIS 19668, at *5 (E.D.N.Y. Apr. 14, 2006); *Anchor Plastics Co. v. Dynex Indus. Plastics Corp.*, 184 U.S.P.Q. (BNA) 482 (D.N.J. 1974). Discovery is normally allowed and use at trial is decided later with a fuller record on relatedness.

Other common ways that third-party interests arise in patent litigation include product development, prior art, and users of an accused device. In the first category, third parties may have been involved, through a joint venture or other collaborative relationship, in the discovery of the claimed invention. The circumstances may lead to questions about ownership, standing, or other matters bearing on validity. In the second category are companies or individuals believed to have published or prac-

ticed the relevant technology before the patentee claims to have conceived of it. The third category comprises users of the accused product whose use of it (for example, combining it into a bigger product that itself infringes) may be relevant to proving contributory infringement or inducement, or demonstrating commercial success. All of these third parties could resist discovery because it is claimed to be unduly burdensome; and indeed their status as outsiders to the dispute is entitled to some consideration. *See, e.g., Katz v. Batavia Marine & Sporting Supplies, Inc.*, 984 F.2d 422, 424 (Fed. Cir. 1993). Third parties can also object because the requested information is extremely sensitive and should not be made available to an arch-competitor. These objections, while legitimate, are usually addressed by the terms of a protective order that appropriately limits access and use of the information. However, sometimes the information, while relevant and protectable in the abstract, can be sought in ways that inappropriately threaten damage to customer relationships. In such circumstances, the court can issue a protective order requiring a heightened showing of need before the discovery goes forward. *See, e.g., Joy Techs., Inc. v. Flakt, Inc.*, 722 F. Supp. 842 (D. Del. 1991).

4.6.10.1 Discovery Regarding Prior License and Settlement Negotiations

The increasing importance of prior license agreements in assessing reasonable royalty damages, *see* § 14.4.3.2.1.4; *Lucent Techs., Inc. v. Gateway, Inc.*, 580 F.3d 1301 (Fed. Cir. 2009), has focused attention on the discoverability of prior confidential license agreements and settlement negotiations. *See ResQNet.com, Inc. v. Lansa, Inc.*, 594 F.3d 860 (Fed. Cir. 2010); *Wordtech Sys. v. Integrated Network Sols., Inc.*, 609 F.3d 1308 (Fed. Cir. 2010); *IP Innovation L.L.C. v. Red Hat, Inc.*, Case No. 2:07-cv-447 (RRR), 705 F. Supp. 2d 687 (E.D. Tex. 2010) (Rader, C.J., circuit judge, sitting by designation). Under these cases, the damages inquiry at all times “must concentrate on compensation for the economic harm caused by infringement of the claimed inventions,” and proof of damages must be tied carefully to “the claimed invention’s footprint in the market place.” *ResQNet.com*, 594 F.3d at 869. The key inquiry is whether the claims describe features that create market demand. The amount of damages must closely reflect the economic value of the patented feature in relation to the accused product. *See, e.g., Lucent Techs.*, 580 F.3d at 1332–33.

Under these decisions, prior license agreements gain heightened importance. In many cases, one party would like to argue that a prior license is not a fair representation of the actual market value, but instead reflects an idiosyncratic negotiation. In these situations, parties will seek discovery regarding the negotiation that resulted in the license. *See Clear With Computers, LLC v. Hyundai Motor Am., Inc.*, 753 F. Supp. 2d 662 (E.D. Tex. 2010).

Despite these decisions, some parties have attempted to block discovery into negotiation documents by claiming that they are protected from disclosure by a so-called settlement privilege that encompasses not only internal documents of one party to the agreement or proposed agreement, but also documents exchanged between the parties. The Federal Circuit closed the door on this alleged privilege in *In re MSTG*, 675 F.3d 1337 (Fed. Cir. 2012). First, the court held that the determination

about whether a settlement privilege bars discovery of negotiation documents, which have relevance to the determination of a reasonable royalty, is a matter of Federal Circuit, rather than regional circuit, law. *Id.* at 1341. Next, the court held that, as a matter of Federal Circuit law, “settlement negotiations related to reasonable royalty and damage calculations are not protected by a settlement negotiation privilege.” *Id.* at 1348. In so holding, it observed that Federal Rule of Evidence 408, which was adopted with congressional approval, includes exceptions that contemplate the discovery of such materials (e.g., the rule permits use of settlement materials to impeach a witness’s credibility). *Id.* at 1343–45. The court also observed that a “settlement privilege” has been recognized by no states and by only one regional circuit (the 6th Circuit). *Id.* at 1342. And a “new privilege” is not necessary to foster settlement, of course, because “disputes are routinely settled without the benefit of a settlement privilege.” *Id.* at 1345. Finally, the court noted that, to prevent abuse of the discovery process, courts have the power to restrict the discoverability or use of information, such as by “limit[ing] discovery of material that is not itself admissible and that was not utilized by the opposing party” in appropriate circumstances. *Id.* at 1346–48.

The purported settlement privilege having been rejected outright, future attempts to shield discovery of negotiation materials in patent cases are most likely to focus on this last observation. Indeed, the court expressly “reserve[d] for another day the issue of what limits can appropriately be placed on discovery of settlement negotiations.” *Id.* at 1347. One such area left untouched, at least explicitly, by *MSTG* is the discoverability or nondiscoverability of materials generated as part of a court-mandated mediation process. But, with respect to materials that were not generated as part of court-mandated mediation, even this language in *MSTG* seems unlikely to yield substantial protection in view of the recent Federal Circuit holdings permitting the use of settlement agreements in factoring damages. As one example, because a patentee’s agreements concerning the patents-in-suit are themselves typically discoverable and admissible, its damages expert has little practical choice but to consider them—in this example, if he or she does not, he or she would have no ability to respond if the opposing party’s damages expert relies upon them in rebutting the patentee’s damages opinions. In this example, once such agreements are considered, discovery of negotiation documents concerning those agreements seems naturally to follow, if for no other reason than to enable the opposing party to determine whether the patentee’s damages expert can be impeached. Of course, this is but one example of the myriad fact patterns from which a dispute of this nature could be presented to a district court, and, general observations about likely outcomes notwithstanding, courts should consider the specific facts of each such dispute carefully.

The *MSTG* decision also noted that other courts had “imposed heightened standards of discovery in order to protect confidential settlement discussions.” *Id.* at 1347. The court did not specifically address whether such heightened standards would apply under Federal Circuit law, but expressly reserved this issue for another day. *Id.* An open question thus remains whether such heightened standards apply to settlement evidence under Federal Circuit law, and if so, under what circumstances they would apply. In 2012, the Federal Circuit took another step toward clarifying *ResQNet.com* and *MSTG*, observing that the admissibility of settlement-related evi-

dence is generally disfavored under the Federal Rules of Evidence because of its inherent unreliability. See *LaserDynamics, Inc. v. Quanta Comput., Inc.*, 694 F.3d 51, 78 (Fed. Cir. 2012). The court noted, however, that the unique facts presented in *ResQNet.com* (where the only relevant evidence in the record was a settlement license) rendered it an outlier to this general rule. *Id.* at 77–78. It is also still unclear whether (and how) Federal Rule of Evidence 408 applies to patent-settlement-related evidence, and if so, how Rule 408 should properly interact with Article VII of the Federal Rules of Evidence.

Appendix 4.1 Table: Circuit Courts' Approach to Sanctions for Spoliation

Reprinted from *Victor Stanley, Inc. v. Creative Pipe, Inc.*, 269 F.R.D. 497, 542 (D. Md. 2010).

Sanctions for Spoliation

Circuit/ Case law	Scope of duty to preserve	Can conduct be culpable per se without consideration of reasonableness?	Culpability and prejudice requirements				What constitutes prejudice	Culpability and corresponding jury instructions
			for sanctions in general	for dispositive sanctions	for adverse inference instruction	for a rebuttable presumption of relevance		
First	It is a duty to preserve potentially relevant evidence a party owns or controls and also a duty to notify the opposing party of evidence in the hands of third parties. <i>Velez v. Marriott PR Mgmt., Inc.</i> , 590 F. Supp. 2d 235, 258 (D.P.R. 2008).	This specific issue has not been addressed.	“The measure of sanctions will depend on the severity of the prejudice suffered.” <i>Velez v. Marriott PR Mgmt., Inc.</i> , 590 F. Supp. 2d 235, 259 (D.P.R. 2008). “[C]arelessness is enough for a district court to consider imposing sanctions.” <i>Driggin v. Am. Sec. Alarm Co.</i> , 141 F. Supp. 2d 113, 123 (D. Me. 2000).	“severe prejudice or egregious conduct” <i>Driggin v. Am. Sec. Alarm Co.</i> , 141 F. Supp. 2d 113, 123 (D. Me. 2000).	“does not require bad faith or comparable bad motive” <i>Trull v. Volkswagon of Am., Inc.</i> , 187 F.3d 88, 95 (1st Cir. 1999); <i>Oxley v. Penobscot County</i> , No. CV-09-21-JAW, 2010 WL 3154975 (D. Me. 2010).	Whether relevance can be presumed has not been addressed.	When spoliation substantially denies a party the ability to support or defend the claim. <i>Velez v. Marriott PR Mgmt., Inc.</i> , 590 F. Supp. 2d 235, 259 (D.P.R. 2008).	Intentional spoliation; permissive adverse inference if the jury finds that the spoliator knew of the lawsuit and the documents’ relevance when it destroyed them. <i>Testa v. Wal-Mart Stores, Inc.</i> , 144 F.3d 173, 178 (1st Cir. 1998).

Circuit/ Case law	Scope of duty to preserve	Can conduct be culpable per se without consideration of reasonableness?	Culpability and prejudice requirements				What constitutes prejudice	Culpability and corresponding jury instructions
			for sanctions in general	for dispositive sanctions	for adverse inference instruction	for a rebuttable presumption of relevance		
Second	Documents that are potentially relevant to likely litigation “are considered to be under a party’s control,” such that the party has a duty to preserve them, “when that party has the right, authority, or practical ability to obtain the documents from a non-party to the action.” <i>In re NTL, Inc. Sec. Litig.</i> , 244 F.R.D. 179, 195 (S.D.N.Y. 2007). The duty extends to key players. <i>Zubulake v. UBS Warburg LLC</i> , 220 F.R.D. 212, 217 (S.D.N.Y. 2003).	Yes; specific actions, such as the failure “to issue a written litigation hold,” constitute gross negligence <i>per se</i> . <i>Pension Comm. of the Univ. of Montreal Pension Plan v. Banc of Am. Sec.</i> , 685 F. Supp. 2d 456, 471 (S.D.N.Y. 2010).	“[D]isciplinary sanctions . . . may be imposed upon a party that has breached a discovery obligation not only through bad faith or gross negligence, but also through ordinary negligence.” <i>Residential Funding Corp. v. DeGeorge Fin. Corp.</i> , 306 F.3d 99, 113 (2d Cir. 2002).	“willfulness, bad faith, or fault on the part of the sanctioned party” <i>Dahoda v. John Deere Co.</i> , 216 F. App’x 124, 125, 2007 WL 491846, at *1 (2d Cir. 2007) (quoting <i>West v. Goodyear Tire & Rubber Co.</i> , 167 F.3d 776, 779 (2d Cir. 1999)).	Gross negligence. <i>Pension Comm. of the Univ. of Montreal Pension Plan v. Banc of Am. Sec.</i> , 685 F. Supp. 2d 456, 478-79 (S.D.N.Y. 2010). Negligence. <i>Residential Funding Corp. v. DeGeorge Fin. Corp.</i> , 306 F.3d 99, 108 (2d Cir. 2002). Intentional conduct. <i>In re Terrorist Bombings of U.S. Embassies in East Africa</i> , 552 F.3d 93, 148 (2d Cir. 2008).	Bad faith or gross negligence. <i>Pension Comm. of the Univ. of Montreal Pension Plan v. Banc of Am. Sec.</i> , 685 F. Supp. 2d 456, 467 (S.D.N.Y. 2010).	When spoliation substantially denies a party the ability to support or defend the claim. <i>Pension Comm. of the Univ. of Montreal Pension Plan v. Banc of Am. Sec.</i> , 685 F. Supp. 2d 456, 479 (S.D.N.Y. 2010).	Grossly negligent conduct; permissible inference of “the relevance of the missing documents and resulting prejudice to the . . . Defendants, subject to the plaintiffs’ ability to rebut the presumption to the satisfaction of the trier of fact.” <i>Pension Comm. of the Univ. of Montreal Pension Plan v. Banc of Am. Sec.</i> , 685 F. Supp. 2d 456, 478 (S.D.N.Y. 2010).

Chapter 4: Discovery

Circuit/ Case law	Scope of duty to preserve	Can conduct be culpable per se without consideration of reasonableness?	Culpability and prejudice requirements				Culpability and corresponding jury instructions
			for sanctions in general	for dispositive sanctions	for adverse inference instruction	for a rebuttable presumption of relevance	
Third	Potentially relevant evidence; “it is essential that the evidence in question be within the party’s control.” <i>Canton v. Kmart Corp.</i> , No. 1:05-CV-143, 2009 WL 2058908, at *2 (D.V.I. July 13, 2009) (quoting <i>Brewer v. Quaker State Oil Refining Corp.</i> , 72 F.3d 326, 334 (3d Cir. 1995)).	No; conduct is culpable if “party [with] notice that evidence is relevant to an action . . . either proceeds to destroy that evidence or allows it to be destroyed by failing to take <i>reasonable</i> precautions.” <i>Canton v. Kmart Corp.</i> , No. 1:05-CV-143, 2009 WL 2058908, at *3 (D.V.I. July 13, 2009) (quoting <i>Mosaid Techs., Inc. v. Samsung Elecs. Co.</i> , 348 F. Supp. 2d 332, 338 (D.N.J. 2004)) (emphasis added).	The degree of fault is considered, and dispositive sanctions “should only be imposed in the most extraordinary of circumstances,” see <i>Mosaid Techs., Inc. v. Samsung Elecs. Co.</i> , 348 F. Supp. 2d 332, 335 (D.N.J. 2004), but a minimum degree of culpability has not been identified.	Negligence. <i>Canton v. Kmart Corp.</i> , No. 1:05-CV-143, 2009 WL 2058908, at *2–3 (D.V.I. July 13, 2009). Intentional conduct. <i>Brewer v. Quaker State Oil Refining Corp.</i> , 72 F.3d 326, 334 (3d Cir. 1995).	Whether relevance can be presumed has not been addressed.	Spoilation of evidence that would have helped a party’s case. <i>In re Hechinger Inv. Co. of Del., Inc.</i> , 489 F.3d 568, 579 (3d Cir. 2007).	Intentional spoliation; permissible inference. <i>Mosaid Techs., Inc. v. Samsung Elecs. Co.</i> , 348 F. Supp. 2d 332, 334 (D.N.J. 2004).

Circuit/ Case law	Scope of duty to preserve	Can conduct be culpable per se without consideration of reasonableness?	Culpability and prejudice requirements				What constitutes prejudice	Culpability and corresponding jury instructions
			for sanctions in general	for dispositive sanctions	for adverse inference instruction	for a rebuttable presumption of relevance		
Fourth	Documents potentially relevant to likely litigation “are considered to be under a party’s control,” such that the party has a duty to preserve them, “when that party has ‘the right, authority, or practical ability to obtain the documents from a non-party to the action.’” <i>Goodman v. Praxair Servs., Inc.</i> , 632 F. Supp. 2d 494, 515 (D. Md. 2009). Also a duty to notify the opposing party of evidence in the hands of third parties. <i>Silvestri v. Gen. Motors Corp.</i> , 271 F.3d 583, 590 (4th Cir. 2001). Duty extends to key players. <i>Goodman</i> , 632 F. Supp. 2d at 512.	The District of Maryland has quoted <i>Zubulake IV</i> , 220 F.R.D. at 220 (“Once the duty to preserve attaches, any destruction of documents is, at a minimum, negligent.”). See <i>Sampson v. City of Cambridge</i> , 251 F.R.D. 172, 179 (D. Md. 2008) (using “fault” to describe conduct ranging from bad faith destruction to ordinary negligence).	The court must “be able to conclude either (1) that the spoliator’s conduct was so egregious as to amount to a forfeiture of his claim, or (2) that the effect of the spoliator’s conduct was so prejudicial that it substantially denied the defendant the ability to defend the claim.” <i>Silvestri v. Gen. Motors Corp.</i> , 271 F.3d 583, 593 (4th Cir. 2001).	The court “must only find that spoliator acted willfully in the destruction of evidence.” <i>Goodman v. Praxair Servs., Inc.</i> , 632 F. Supp. 2d 494, 519 (D. Md. 2009).	Willful behavior. <i>Sampson v. City of Cambridge</i> , 251 F.R.D. 172, 179 (D. Md. 2008).	When spoliation substantially denies a party the ability to support or defend the claim. <i>Goodman v. Praxair Servs., Inc.</i> , 632 F. Supp. 2d 494, 519 (D. Md. 2009); <i>Sampson v. City of Cambridge</i> , 251 F.R.D. 172, 180 (D. Md. 2008).	Willful spoliation; adverse jury instruction, but not the “series of fact-specific adverse jury instructions” that the plaintiff requested. <i>Goodman v. Praxair Servs., Inc.</i> , 632 F. Supp. 2d 494, 523 (D. Md. 2009).	

Circuit/ Case law	Scope of duty to preserve	Can conduct be culpable per se without consideration of reasonableness?	Culpability and prejudice requirements				What constitutes prejudice	Culpability and corresponding jury instructions
			for sanctions in general	for dispositive sanctions	for adverse inference instruction	for a rebuttable presumption of relevance		
Fifth	Party with control over potentially relevant evidence has a duty to preserve it; scope includes evidence in possession of "employees likely to have relevant information, i.e., 'the key players.'" <i>Tango Transp., LLC v. Transp. Int'l Pool, Inc.</i> , No. 5:08-CV-0559, 2009 WL 3254882, at *3 (W.D. La. Oct. 8, 2009).	No: "Whether preservation or discovery conduct is acceptable in a case depends on what is reasonable, and that in turn depends on whether what was done or not done- was proportional to that case and consistent with clearly established applicable standards." <i>Rimkus Consulting Grp., Inc. v. Cammarata</i> , 688 F. Supp. 2d 598, 613 (S.D. Tex. 2010).	"some degree of culpability" <i>Rimkus Consulting Grp., Inc. v. Cammarata</i> , 688 F. Supp. 2d 598, 613 (S.D. Tex. 2010).	Bad faith (and prejudice). <i>Rimkus Consulting Grp., Inc. v. Cammarata</i> , 688 F. Supp. 2d 598, 614 (S.D. Tex. 2010).	Bad faith. <i>Rimkus Consulting Grp., Inc. v. Cammarata</i> , 688 F. Supp. 2d 598, 617 (S.D. Tex. 2010).	"The Fifth Circuit has not explicitly addressed whether even bad faith destruction of evidence allows a court to presume that the destroyed evidence was relevant or its loss prejudicial." <i>Rimkus Consulting Grp., Inc. v. Cammarata</i> , 688 F. Supp. 2d 598, 617-18 (S.D. Tex. 2010).	When spoliation substantially denies a party the ability to support or defend the claim. <i>Rimkus Consulting Grp., Inc. v. Cammarata</i> , 688 F. Supp. 2d 598, 613 (S.D. Tex. 2010).	Willful spoliation; jury instruction would "ask the jury to decide whether the defendants intentionally deleted e-mails and attachments to prevent their use in litigation." <i>Rimkus Consulting Grp., Inc. v. Cammarata</i> , 688 F. Supp. 2d 598, 620, 646 (S.D. Tex. 2010).

Circuit/ Case law	Scope of duty to preserve	Can conduct be culpable per se without consideration of reasonableness?	Culpability and prejudice requirements				Culpability and corresponding jury instructions
			for sanctions in general	for dispositive sanctions	for adverse inference instruction	for a rebuttable presumption of relevance	
	It is a duty to preserve potentially relevant evidence that a party owns or controls and to notify the opposing party of evidence in the hands of third parties. <i>Jain v. Memphis Shelby Airport Auth.</i> , No. 08-2119-STA-dkv, 2010 WL 711328, at *2 (W.D. Tenn. Feb. 25, 2010). Duty extends to key players <i>In re Nat'l Century Fin. Enters., Inc. Fin. Inv. Litig.</i> , No. 2:03-md-1565, 2009 WL 2169174, at *11 (S.D. Ohio July 16, 2009).	This specific issue has not been addressed. In <i>BancorpSouth Bank v. Herter</i> , 643 F. Supp. 2d 1041, 1061 (W.D. Tenn. 2009), the court quoted <i>Zubulake IV</i> , 220 F.R.D. at 220 (“Once the duty to preserve attaches, any destruction of documents is, at a minimum, negligent.”), but it also analyzed the defendant’s conduct to make the finding that it was “more than negligent.”	Bad faith (intentional) destruction, gross negligence, or ordinary negligence. <i>In re Global Technovations, Inc.</i> , 431 B.R. 739, 780 (Bankr. E.D. Mich. 2010) (equating intentional and bad faith conduct).	willfulness, bad faith, or fault <i>In re Global Technovations, Inc.</i> , 431 B.R. 739, 779 (Bankr. E.D. Mich. 2010) (using “fault” to describe conduct ranging from intentional conduct to ordinary negligence). Other cases in circuit define “fault” as “objectively unreasonable behavior.” <i>E.g., BancorpSouth Bank v. Herter</i> , 643 F. Supp. 2d 1041, 1060 (W.D. Tenn. 2009); <i>Jain v. Memphis Shelby Airport Auth.</i> , No. 08-2119-STA-dkv, 2010 WL 711328, at *3 (W.D. Tenn. Feb. 25, 2010); <i>Forest Labs, Inc. v. Caraco Pharm. Labs., Ltd.</i> , No. 06-CV-13143, 2009 WL 998402, at *5–6 (E.D. Mich. Apr. 14, 2009).	Bad faith. <i>In re Global Technovations, Inc.</i> , 431 B.R. 739, 782 (Bankr. E.D. Mich. 2010). Bad faith not required <i>Miller v. Home Depot USA, Inc.</i> , No. 3-08-0281, 2010 WL 373860, at *1 (M.D. Tenn. Jan. 28, 2010). Ordinary negligence <i>Jain v. Memphis Shelby Airport Auth.</i> , No. 08-2119-STA-dkv, 2010 WL 711328, at *2 (W.D. Tenn. Feb. 25, 2010).	“The spoliating party bears the burden of establishing lack of prejudice to the opposing party, a burden the Sixth Circuit has described as ‘an uphill battle.’” <i>Jain v. Memphis Shelby Airport Auth.</i> , No. 08-2119-STA-dkv, 2010 WL 711328, at *4 (W.D. Tenn. Feb. 25, 2010).	Unintentional conduct; permissible inference. <i>Jain v. Memphis Shelby Airport Auth.</i> , No. 08-2119-STA-dkv, 2010 WL 711328, at *4-5 (W.D. Tenn. Feb. 25, 2010).

Sixth

Circuit/ Case law	Scope of duty to preserve	Can conduct be culpable per se without consideration of reasonableness?	Culpability and prejudice requirements					What constitutes prejudice	Culpability and corresponding jury instructions
			for sanctions in general	for dispositive sanctions	for adverse inference instruction	for a rebuttable presumption of relevance			
Seventh	Duty to preserve potentially relevant evidence parity has control over <i>Jones v. Bremen High Sch. Dist.</i> 228, No. 08-C-3548, 2010 WL 2106640, at *5 (N.D. Ill. May 25, 2010).	No: Breach is fail-ure to act reason-ably under the cir-cumstances. <i>Jones v. Bremen High Sch. Dist.</i> 228, No. 08-C-3548, 2010 WL 2106640, at *6-7 (N.D. Ill. May 25, 2010). “The failure to in-stitute a document retention policy, in the form of a litiga-tion hold, is rele-vant to the court’s consideration, but it is not <i>per se</i> evi-dence of sanction-able conduct.” <i>Haynes v. Dart</i> , No. 08 C 4834, 2010 WL 140387, at *4 (N.D. Ill. Jan. 11, 2010).	Willfulness, bad faith, or fault. <i>Jones v. Bremen High Sch. Dist.</i> 228, No. 08-C-3548, 2010 WL 2106640, at *5 (N.D. Ill. May 25, 2010) (stat-ing that fault is based on the reasonableness of the party’s conduct). Bad faith. <i>BP Amoco Chemical Co. v. Flint Hills Re-sources, LLC</i> , No. 05 C 5, 2010 WL 1131660, at *24 (N.D. Ill. Mar. 25, 2010).	Willfulness, bad faith, or fault. <i>In re Kmart Corp.</i> , 371 B.R. 823, 840 (Bankr. N.D. Ill. 2007) (noting that fault, while based on reasonable-ness, is more than a “slight error in judg-ment”) (citation omitted)	Bad faith. <i>Faas v. Sears, Roebuck & Co.</i> , 532 F.3d 633, 644 (7th Cir. 2008).	Unintentional conduct is in-sufficient for presumption of relevance. <i>In re Kmart Corp.</i> , 371 B.R. 823, 853-54 (Bankr. N.D. Ill. 2007).	When spolia-tion substan-tially denies a party the abil-ity to support or defend the claim. <i>Krumwiede v. Brighton As-socs., L.L.C.</i> , No. 05-C-3003, 2006 WL 1308629, at *10 (N.D. Ill. May 8, 2006). When spolia-tion substan-tially denies a party the abil-ity to support or defend the claim OR de-lays produc-tion of evi-dence. <i>Jones v. Bremen High Sch. Dist.</i> 228, No. 08-C-3548, 2010 WL 2106640, at *8-9 (N.D. Ill. May 25, 2010).	Grossly negli-gent conduct; jury instruction to inform the jury of the de-fendant’s duty and breach thereof. <i>Jones v. Bremen High Sch. Dist.</i> 228, No. 08-C-3548, 2010 WL 2106640, at *10 (N.D. Ill. May 25, 2010).	

Circuit/ Case law	Scope of duty to preserve	Can conduct be culpable per se without consideration of reasonableness?	Culpability and prejudice requirements				Culpability and corresponding jury instructions	
			for sanctions in general	for dispositive sanctions	for adverse inference instruction	for a rebuttable presumption of relevance		
Eighth	Duty to preserve potentially relevant documents in party's possession. <i>Dillon v. Nissan Motor Co.</i> , 986 F.2d 263, 267 (8th Cir. 1993).	Courts in the Eighth Circuit have not found conduct culpable without analyzing the facts, although reasonableness is not discussed.	Bad faith. <i>Wright v. City of Salisbury</i> , No. 2:07CV0056 AGF, 2010 WL 126011, at *2 (E.D. Mo. Apr. 6, 2010).	Bad faith. <i>Johnson v. Avco Corp.</i> , No. 4:07CV 1695 CDP, 2010 WL 1329361, at *13 (E.D. Mo. 2010); <i>Menz v. New Holland N. Am., Inc.</i> , 440 F.3d 1002, 1006 (8th Cir. 2006); <i>Holland N. Am., Inc.</i> , 440 F.3d 1002, 1006 (8th Cir. 2006).	Bad faith. <i>Greyhound Lines, Inc. v. Wade</i> , 485 F.3d 1032, 1035 (8th Cir. 2007); <i>Menz v. New Holland N. Am., Inc.</i> , 440 F.3d 1002, 1006 (8th Cir. 2006); <i>Stevenson v. Union Pac. RR</i> , 354 F.3d 739, 747 (8th Cir. 2004) (bad faith required if spoliation happens prelitigation). Bad faith is not required to sanction for "the ongoing destruction of records during litigation and discovery." <i>Stevenson</i> , 354 F.3d at 750; <i>Mecca Tech, Inc. v. Kiser</i> , 2008 WL 6010937, at *8 (D. Neb. 2008) (same), <i>adopted in part</i> , No. 8:05CV570, 2009 WL 1152267 (D. Neb. Apr. 23, 2009).	This issue has not been addressed, but it has been stated that there is no presumption of irrelevance of intentionally destroyed documents. <i>Alexander v. Nat'l Farmers Org.</i> , 687 F.2d 1173, 1205 (8th Cir. 1982).	Destruction of evidence that "may have [been] helpful." <i>Dillon v. Nissan Motor Co.</i> , 986 F.2d 263, 268 (8th Cir. 1993). "irreparable injury to plaintiffs' claims" <i>Monsanto Co. v. Woods</i> , 250 F.R.D. 411, 414 (E.D. Mo. 2008).	"destruction was not 'willful' or malicious," but plaintiffs' counsel should have known to preserve the evidence; jury was instructed that "an adverse inference may be drawn from plaintiffs' failure to preserve the vehicle" <i>Bass v. Gen. Motors Corp.</i> , 929 F. Supp. 1287, 1290 (W.D. Mo. 1996), <i>aff'd on this ground</i> , 150 F.3d 842, 851 (8th Cir. 1998).

Circuit/ Case law	Scope of duty to preserve	Can conduct be culpable per se without consideration of reasonableness?	Culpability and prejudice requirements				Culpability and corresponding jury instructions	
			for sanctions in general	for dispositive sanctions	for adverse inference instruction	for a rebuttable presumption of relevance		What constitutes prejudice
Ninth	Duty to preserve potentially relevant evidence in party's possession <i>Leon v. IDX Systems Corp.</i> , 2004 WL 5571412, at *3 (W.D. Wash. 2004), <i>aff'd</i> , 464 F.3d 951 (9th Cir. 2006). Duty extends to key players. <i>Hous. Rights Ctr. v. Sterling</i> , 2005 WL 3320739, at *3 (C.D. Cal. Mar. 2, 2005).	In <i>Hous. Rights Ctr. v. Sterling</i> , 2005 WL 3320739, at *3 (C.D. Cal. Mar. 2, 2005), the court quoted <i>Zubulake IV</i> , 220 F.R.D. at 220 ("Once the duty to preserve attaches, any destruction of documents is, at a minimum, negligent."), and found that defendants' "[d]estruction of documents during ongoing litigation was, at a minimum, negligent."	Bad faith not required. <i>Dae Kon Kwon v. Costco Wholesale Corp.</i> , No. CIV. 08-360 JMSBMK, 2010 WL 571941, at *2 (D. Haw. 2010); <i>Carl Zeiss Vision Intern. GmbH v. Signet Armolite, Inc.</i> , No. 07CV0894 DMS(POR), 2010 WL 743792, at *15 (S.D. Cal. Mar. 1, 2010), <i>amended on other grounds</i> , 2010 WL 1626071 (S.D. Cal. Apr. 21, 2010).	Willfulness, bad faith, or fault. <i>Dae Kon Kwon v. Costco Wholesale Corp.</i> , No. CIV. 08-360 JMSBMK, 2010 WL 571941, at *2 (D. Haw. 2010) (requiring that party "engaged deliberately in deceptive practices") " [D]isobedient conduct not shown to be outside the control of the litigant' is all that is required to demonstrate willfulness, bad faith, or fault." <i>Henry v. Gill Indus.</i> , 983 F.2d 943, 948 (9th Cir. 1993).	Bad faith or gross negligence. <i>Karnazes v. County of San Mateo</i> , No. 09-0767 MMC (MEJ), 2010 WL 2672003, at *2 (N.D. Cal. July 2, 2010). Bad faith not required. <i>Otsuka v. Polo Ralph Lauren Corp.</i> , No. C 07- 02780 SJ, 2010 WL 366653, at *3 (N.D. Cal. Jan. 25, 2010).	This issue has not been addressed.	When spoliation substantially denies a party the ability to support or defend the claim. <i>Henry v. Gill Indus.</i> , 983 F.2d 943, 948 (9th Cir. 1993).	The Court's research has not located a case in which the court granted an adverse inference instruction and stated what the instruction would be.

Circuit/ Case law	Scope of duty to preserve	Can conduct be culpable per se without consideration of reasonableness?	Culpability and prejudice requirements				Culpability and corresponding jury instructions
			for sanctions in general	for dispositive sanctions	for adverse inference instruction	for a rebuttable presumption of relevance	
Tenth	Duty extends to key players. <i>Pinstripe, Inc. v. Manpower, Inc.</i> , No. 07-CV-620-GKF-PJC, 2009 WL 2252131, at *1 (N.D. Okla. July 29, 2009). A party with possession of potentially relevant evidence has a duty to preserve it; even if the party relinquishes ownership or custody, it must contact the new custodian to preserve the evidence. <i>Jordan F. Miller Corp. v. Mid-Continent Aircraft Serv.</i> , 139 F.3d 912, 1998 WL 68879, at *5-6 (10th Cir. 1998).	No. <i>Procter & Gamble Co. v. Haugen</i> , 427 F.3d 727, 739 n.8 (10th Cir. 2005) (stating that district court must consider Rule 26(b)(2)(C)(iii), which requires the court to limit discovery if “the burden or expense of the proposed discovery outweighs its likely benefit”).	Bad faith not required. <i>Hatfield v. Wal-Mart Stores, Inc.</i> , 335 F. App’x 796, 804 (10th Cir. 2009). Negligence. <i>Pipes v. UPS, Inc.</i> , No. CIV.A.07-1762, 2009 WL 2214990, at *1 (W.D. La. July 22, 2009).	“willfulness, bad faith, or [some] fault” <i>Procter & Gamble Co. v. Haugen</i> , 427 F.3d 727, 738 (10th Cir. 2005) (using language originally in <i>Societe Internationale v. Rogers</i> , 357 U.S. 197, 212 (1958), which distinguished “fault” from a party’s inability to act otherwise).	Bad faith. <i>Turner v. Pub. Serv. Co. of Colo.</i> , 563 F.3d 1136, 1149 (10th Cir. 2009). Neither bad faith nor intentionality required. <i>Hatfield v. Wal-Mart Stores, Inc.</i> , 335 F. App’x 796, 804 (10th Cir. 2009); <i>Schrieber v. Fed. Ex. Corp.</i> , No. 09-CV-128-JHP-PJC, 2010 WL 1078463 (N.D. Okla. Mar. 18, 2010).	Although this specific issue has not been addressed, the court declined to “create a presumption in favor of spoliation whenever a moving party can prove that records that might have contained relevant evidence have been destroyed” in <i>Crandall v. City & County of Denver, Colo.</i> , No. 05-CV-00242-MSK-MEH, 2006 WL 2683754, at *2 (D. Colo. Sept. 19, 2006).	Bad faith; adverse inference instruction. <i>Smith v. Slifer Smith & Framp-ton/Vail Assocs. Real Estate, LLC</i> , No. CIV A 06CV02206-JLK, 2009 WL 482603, at *13 (D. Colo. Feb. 25, 2009).

Chapter 4: Discovery

Circuit/ Case law	Scope of duty to preserve	Can conduct be culpable per se without consideration of reasonableness?	Culpability and prejudice requirements				What constitutes prejudice	Culpability and corresponding jury instructions
			for sanctions in general	for dispositive sanctions	for adverse inference instruction	for a rebuttable presumption of relevance		
	Duty to preserve potentially relevant evidence that party has "access to and control over" <i>Natl Grange Mut. Ins. Co. v. Hearth & Home, Inc.</i> , No. CIV.A. 2:06CV54WCO, 2006 WL 5157694 at *5 (N.D. Ga. Dec. 19, 2006).	Courts in the Eleventh Circuit have not found conduct culpable without analyzing the facts, although reasonableness is not discussed.	Bad faith. <i>Managed Care Solutions, Inc. v. Essent Healthcare, Inc.</i> , No. 09-60351-CIV, 2010 WL 3368654, at *4 (S.D. Fla. Aug. 23, 2010). Degree of culpability is weighed against prejudice caused by spoliation. <i>Flury v. Daimler Chrysler Corp.</i> , 427 F.3d 939, 945 (11th Cir. 2005); <i>Brown v. Chertoff</i> , 563 F. Supp. 2d 1372, 1381 (S.D. Ga. 2008).	Bad faith. <i>Managed Care Solutions, Inc. v. Essent Healthcare, Inc.</i> , No. 09-60351-CIV, 2010 WL 3368654, at *13 (S.D. Fla. Aug. 23, 2010).	Bad faith. <i>Penalty Kick Mgmt. Ltd. v. Coca Cola Co.</i> , 318 F.3d 1284, 1294 (11th Cir. 2003); <i>Managed Care Solutions, Inc. v. Essent Healthcare, Inc.</i> , No. 09-60351-CIV, 2010 WL 3368654, at *13 (S.D. Fla. Aug. 23, 2010).	This issue has not been addressed.	Spoilation of evidence that was not just relevant but "crucial" to a claim or defense. <i>Managed Care Solutions, Inc. v. Essent Healthcare, Inc.</i> , No. 09-60351-CIV, 2010 WL 3368654, at *8 (S.D. Fla. Aug. 23, 2010).	Negligence; jury to be instructed that the destruction raises a rebuttable inference that the evidence supported plaintiff's claim. <i>Brown v. Chertoff</i> , 563 F. Supp. 2d 1372, 1381 (S.D. Ga. 2008) (but other courts in Eleventh Circuit will not order any sanctions without bad faith).

Eleventh

Circuit/ Case law	Scope of duty to preserve	Can conduct be culpable per se without consideration of reasonableness?	Culpability and prejudice requirements				Culpability and corresponding jury instructions	
			for sanctions in general	for dispositive sanctions	for adverse inference instruction	for a rebuttable presumption of relevance		
D.C.	Duty to preserve potentially relevant evidence “within the ability of the defendant to produce it.” <i>Friends for All Children v. Lockheed Aircraft Corp.</i> , 587 F. Supp. 180, 189 (D.D.C.), <i>modified</i> , 593 F. Supp. 388 (D.D.C.), <i>aff’d</i> , 746 F.2d 816 (D.C. Cir. 1984).	Courts in the D.C. Circuit have not found conduct culpable without analyzing the facts, although reasonableness is not discussed.	Case law addresses specific sanctions, rather than sanctions generally.	Bad faith. <i>Shepherd v. Am. Broad Cos.</i> , 62 F.3d 1469, 1477 (D.C. Cir. 1995); <i>D’Onofrio v. SFX Sports Grp., Inc.</i> , No. 06-687 (JDB/JMF), 2010 WL 3324964, at *5 (D.D.C. Aug. 24, 2010).	Negligent or deliberate. <i>Mazloum v. D.C. Metro. Police Dep’t</i> , 530 F. Supp. 2d 282, 292 (D.D.C. 2008); <i>More v. Snow</i> , 480 F. Supp. 2d 257, 274–75 (D.D.C. 2007); <i>D’Onofrio v. SFX Sports Grp., Inc.</i> , No. 06-687 (JDB/JMF), 2010 WL 3324964, at *10 (D.D.C. Aug. 24, 2010) (not for mere negligence unless “the interests in righting the evidentiary balance and in the deterring of others trumps the lacuna that a logician would detect in the logic of giving such an instruction”).	This issue has not been addressed.	Case law states that the spoliated evidence must have been relevant, i.e., information that would have supported a claim or defense, but it does not address prejudice.	“[A]ny adverse inference instruction grounded in negligence would be considerably weaker in both language and probative force than an instruction regarding deliberate destruction.” <i>Mazloum v. D.C. Metro. Police Dep’t</i> , 530 F. Supp. 2d 282, 293 (D.D.C. 2008).

Chapter 4: Discovery

Circuit/ Case law	Scope of duty to preserve	Can conduct be culpable per se without consideration of reasonableness?	Culpability and prejudice requirements				What constitutes prejudice	Culpability and corresponding jury instructions
			for sanctions in general	for dispositive sanctions	for adverse inference instruction	for a rebuttable presumption of relevance		
Federal								<p>"In reviewing sanction orders, [the Federal Circuit] applies the law of the regional circuit from which the case arose." <i>Monsanto Co. v. Ralph</i>, 382 F.3d 1374, 1380 (Fed. Cir. 2004). In <i>Consolidated Edison Co. of N.Y., Inc. v. United States</i>, 90 Fed. Cl. 228, 255 n.20 (Ct. Cl. 2009), the United States Court of Federal Claims observed that "the United States Court of Appeals for the Federal Circuit, has not definitively addressed whether a finding of bad faith is required before a court can find spoliation or impose an adverse inference or other sanction. Because many of the spoliation cases decided to date by the Federal Circuit have been patent cases in which the Federal Circuit applies the law of the relevant regional circuit, the Federal Circuit has not had the opportunity to announce a position binding on this court as to a possible 'bad faith' or other standard to trigger a spoliation of evidence sanction. Consequently, judges of the United States Court of Federal Claims have taken differing positions on the "bad faith" requirement. <i>Compare United Med. Supply Co. v. United States</i>, 77 Fed. Cl. 257, 268 (2007) ("[A]n injured party need not demonstrate bad faith in order for the court to impose, under its inherent authority, spoliation sanctions."), <i>with Columbia First Bank, FSB v. United States</i>, 54 Fed. Cl. 693, 703 (2002) (noting findings of bad faith are required before the court can determine that there was spoliation)." (Citation omitted.)</p>

Appendix 4.2 Federal Circuit Model Order Regarding e-Discovery in Patent Cases¹

AN E-DISCOVERY MODEL ORDER

INTRODUCTION

Since becoming a staple of American civil litigation, e-discovery has been the subject of extensive review, study, and commentary. See *The Sedona Principles: Best Practices, Recommendations & Principles for Addressing Electronic Document Production* (2d ed. June 2007). In view of the growing concern about e-discovery, the Federal Rules of Civil Procedure were amended in 2006 to address e-discovery more fully. Likewise, several district courts have adopted local e-discovery rules.²

Despite these amendments, e-discovery continues to present a broad spectrum of challenges, such as preservation obligations, production format, and the disproportionate cost of e-discovery.³ Patent cases, in particular, tend to suffer from disproportionately high discovery expenses. See Emery G. Lee III & Thomas E. Willging, *Litigation Costs in Civil Cases: Multivariate Analysis* 8 (Federal Judicial Center 2010) (“Intellectual Property cases had costs almost 62% higher, all else equal, than the baseline ‘Other’ category.”); see also Thomas E. Willging et al., *Discovery and Disclosure Practice, Problems, and Proposals for Change: A Case-Based National Survey of Counsel in Closed Federal Civil Cases*

1. Note that the E-Discovery model order included here was published by the Advisory Council for the Federal Circuit. The Federal Circuit itself has not sponsored or endorsed the Advisory Council’s model orders. See <http://www.cafc.uscourts.gov/the-court/advisory-council.html>; http://www.cafc.uscourts.gov/images/model_orders.pdf.

2. District Courts in Delaware, Kansas and Maryland have adopted e-discovery local rules. The Seventh Circuit has adopted an e-discovery pilot program.

3. The following are the main cost areas for e-discovery:

Collection: Forensically sound (e.g., preserving the document date) collection can require a trained specialist. Costs will include vendor fees and/or licensing fees, and media related charges. Inactive data requires restoration and software licensing fees.

Processing: Requires use of licensed assessment or review tools (more than 1 tool are often used for this process). Expenses will include data and text extraction, deduplication, imaging fees, project management time and potential hosting fees. Frequently includes narrowing or broadening the scope of collection based on results.

Review: Requires continued hosting and licensing fees. Project management time is necessary for database setup and management, additional keyword filtering/assessment and searching. If human review is involved, this is the largest area of cost.

Production: Requires any additional data and image conversion, text extraction and/or appropriate language OCR generation. Tech time will include dealing with problematic files (e.g., Excel). Also requires endorsement and control numbering. Costs will also be incurred for project management/tech time and media related charges.

Post Production: Project management and load time for importing productions into production review tool or index. Additional costs for associating native files to records.

38–39 (Federal Judicial Center 1997) (finding that patent cases “stood out for their high discovery expenses”). Such expenses are compounded when attorneys use discovery tools as tactical weapons, which hinders the “just, speedy, and inexpensive determination of every action and proceeding.” Fed. R. Civ. P. 1.

In recent years, the exponential growth of and reliance on electronic documents and communications has exacerbated such discovery abuses. Excessive e-discovery, including disproportionate, overbroad email production requests, carry staggering time and production costs that have a debilitating effect on litigation. Routine requests seeking all categories of Electronically Stored Information often result in mass productions of marginally relevant and cumulative documents. Generally, the production burden of these expansive requests outweighs the minimal benefits of such broad disclosure.

Most discovery in patent litigation centers on what the patent states, how the accused products work, what the prior art discloses, and the proper calculation of damages. These topics are normally the most consequential in patent cases. Thus, far-reaching e-discovery, such as mass email searches, is often tangential to adjudicating these issues.

As technology and knowledge play an increasingly important role in our economy, the courts must not become an intolerably expensive way to resolve patent disputes. Specifically, litigation costs should not be permitted to unduly interfere with the availability of the court to those who seek to vindicate their patent rights—the enforcement of such rights is both an obligation of the legal system and important to innovation. Likewise, disproportionate expense should not be permitted to force those accused of infringement to acquiesce to nonmeritorious claims. This only serves as an unhealthy tax on legitimate commerce.

Fortunately, district courts have inherent power to control their dockets to further “economy of time and effort for itself, for counsel and for litigants.” *Landis v. North Am. Co.*, 299 U.S. 248, 254 (1936). Our objective is thus narrow, but important. The accompanying Model Order Limiting E-Discovery in Patent Cases is intended to be a helpful starting point for district courts to use in requiring the responsible, targeted use of e-discovery in patent cases. The goal of this Model Order is to promote economic and judicial efficiency by streamlining e-discovery, particularly email production, and requiring litigants to focus on the proper purpose of discovery—the gathering of material information—rather than permitting unlimited fishing expeditions. It is further intended to encourage discussion and public commentary by judges, litigants, and other interested parties regarding e-discovery problems and potential solutions.

DISCUSSION OF THE MODEL ORDER

Hard-worn experience in patent cases and recent commentary teach that efforts to identify comprehensively the discovery issues or to produce all “relevant” documents at once at the outset of the case can result in the vastly overbroad production of e-discovery. Indeed, the practice of gathering huge amounts of information at the front of a case and running broad key searches as the issues emerge has come under increasing question. The *Judges’ Guide to Cost-Effective E-Discovery* critiqued this practice sharply:

Some argue that e-discovery is best accomplished by taking large amounts of data from clients and then applying keyword or other searches or filters. While, in some rare cases, this method might be the only option, it is also apt to be the most expensive. In fact, keyword searching against large volumes of data to find relevant information is a challenging, costly, and imperfect process.

Anne Kershaw & Joe Howie, *Judges' Guide to Cost-Effective E-Discovery* 4 (Federal Judicial Center 2010).

Hence, this Model Order requires a discovery process whereby the parties exchange core documentation concerning the patent, the accused product, the prior art, and the finances before making email production requests. Moreover, email production requests should be focused on a particular issue for which that type of discovery is warranted. Much as Federal Rule of Civil Procedure 30 presumptively limits cases to ten depositions and seven hours per deposition,⁴ this Model Order presumptively limits the number of custodians and search terms for all email production requests. However, the parties may jointly agree to modify these limits or request court modification for good cause.

This is not to say a discovering party should be precluded from obtaining more e-discovery than agreed upon by the parties or allowed by the court. Rather, the discovering party shall bear all reasonable costs of discovery that exceeds these limits. This will help ensure that discovery requests are being made with a true eye on the balance between the value of the discovery and its cost.

A large source of e-discovery cost is the pre-production review of documents by attorneys or other human reviewers. Even with claw-back provisions, this pre-production review is often undertaken to avoid the disclosure of privileged or other sensitive documents to adversaries. Accordingly, this Model Order addresses concerns regarding waiver of attorney-client privilege and work product protection in order to minimize human pre-production review.

E-Discovery Committee

Chief Judge James Ware (N.D. Cal.)

Judge Virginia Kendall (N.D. Ill.)

Magistrate Judge Chad Everingham (E.D. Tex.)

Chief Judge Randall Rader (Fed. Cir.)

Tina Chappell

Richard "Chip" Lutton

Joe Re

Edward Reines

Steve Susman

John Whealan

4. Such limits have reformed deposition practice, making it more efficient. *See* Fed. R. Civ. P. 30(a), 1993 Advisory Committee Notes (explaining that Rule 30 limits the number of depositions a party may take in order to "to emphasize that counsel have a professional obligation to develop a mutual cost-effective plan for discovery in the case").

Addendum: Discovery Model Order

Plaintiff,)
)
v.)
)
Defendant.) Case No.
)

[MODEL] ORDER REGARDING E-DISCOVERY IN PATENT CASES

The Court ORDERS as follows:

1. This Order supplements all other discovery rules and orders. It streamlines Electronically Stored Information (“ESI”) production to promote a “just, speedy, and inexpensive determination” of this action, as required by Federal Rule of Civil Procedure 1.

2. This Order may be modified for good cause. The parties shall jointly submit any proposed modifications within 30 days after the Federal Rule of Civil Procedure 16 conference. If the parties cannot resolve their disagreements regarding these modifications, the parties shall submit their competing proposals and a summary of their dispute.

3. Costs will be shifted for disproportionate ESI production requests pursuant to Federal Rule of Civil Procedure 26. Likewise, a party’s nonresponsive or dilatory discovery tactics will be cost-shifting considerations.

4. A party’s meaningful compliance with this Order and efforts to promote efficiency and reduce costs will be considered in cost-shifting determinations.

5. General ESI production requests under Federal Rules of Civil Procedure 34 and 45 shall not include metadata absent a showing of good cause. However, fields showing the date and time that the document was sent and received, as well as the complete distribution list, shall generally be included in the production.

6. General ESI production requests under Federal Rules of Civil Procedure 34 and 45 shall not include email or other forms of electronic correspondence (collectively “email”). To obtain email parties must propound specific email production requests.

7. Email production requests shall only be propounded for specific issues, rather than general discovery of a product or business.

8. Email production requests shall be phased to occur after the parties have exchanged initial disclosures and basic documentation about the patents, the prior art, the accused instrumentalities, and the relevant finances. While this provision does not require the production of such information, the Court encourages prompt and early production of this information to promote efficient and economical streamlining of the case.

9. Email production requests shall identify the custodian, search terms, and time frame. The parties shall cooperate to identify the proper custodians, proper search terms and proper timeframe.

10. Each requesting party shall limit its email production requests to a total of five custodians per producing party for all such requests. The parties may jointly agree to modify this limit without the Court's leave. The Court shall consider contested requests for up to five additional custodians per producing party, upon showing a distinct need based on the size, complexity, and issues of this specific case. Should a party serve email production requests for additional custodians beyond the limits agreed to by the parties or granted by the Court pursuant to this paragraph, the requesting party shall bear all reasonable costs caused by such additional discovery.

11. Each requesting party shall limit its email production requests to a total of five search terms per custodian per party. The parties may jointly agree to modify this limit without the Court's leave. The Court shall consider contested requests for up to five additional search terms per custodian, upon showing a distinct need based on the size, complexity, and issues of this specific case. The search terms shall be narrowly tailored to particular issues. Indiscriminate terms, such as the producing company's name or its product name, are inappropriate unless combined with narrowing search criteria that sufficiently reduce the risk of overproduction. A conjunctive combination of multiple words or phrases (*e.g.*, "computer" and "system") narrows the search and shall count as a single search term. A disjunctive combination of multiple words or phrases (*e.g.*, "computer" or "system") broadens the search, and thus each word or phrase shall count as a separate search term unless they are variants of the same word. Use of narrowing search criteria (*e.g.*, "and," "but not," "w/x") is encouraged to limit the production and shall be considered when determining whether to shift costs for disproportionate discovery. Should a party serve email production requests with search terms beyond the limits agreed to by the parties or granted by the Court pursuant to this paragraph, the requesting party shall bear all reasonable costs caused by such additional discovery.

12. The receiving party shall not use ESI that the producing party asserts is attorney-client privileged or work product protected to challenge the privilege or protection.

13. Pursuant to Federal Rule of Evidence 502(d), the inadvertent production of a privileged or work product protected ESI is not a waiver in the pending case or in any other federal or state proceeding.

14. The mere production of ESI in a litigation as part of a mass production shall not itself constitute a waiver for any purpose.

Appendix 4.3

Model Orders for e-Discovery

This Appendix includes guidelines and model orders from various districts, focused on the discovery process for ESI.

Northern District of California: Guidelines for the Discovery of Electronically Stored Information and Model Stipulation and Order Re: Discovery of Electronically Stored Information for Patent Litigation

District of Delaware: Default Standard for Discovery, Including Discovery of Electronically Stored Information (“ESI”)

District of Kansas: Guidelines for Cases Involving Electronically Stored Information

Western District of New York: [Model] Order Regarding E-Discovery in Patent Cases

Eastern District of Texas: [Model] Order Regarding E-Discovery in Patent Cases

Northern District of California
United States District Court

Northern District of California Guidelines for the Discovery of Electronically Stored Information

GENERAL GUIDELINES

Guideline 1.01 (Purpose)

Discoverable information today is mainly electronic. The discovery of electronically stored information (ESI) provides many benefits such as the ability to search, organize, and target the ESI using the text and associated data. At the same time, the Court is aware that the discovery of ESI is a potential source of cost, burden, and delay.

These Guidelines should guide the parties as they engage in electronic discovery. The purpose of these Guidelines is to encourage reasonable electronic discovery with the goal of limiting the cost, burden and time spent, while ensuring that information subject to discovery is preserved and produced to allow for fair adjudication of the merits. At all times, the discovery of ESI should be handled consistently with Fed. R. Civ. P. 1 to “secure the just, speedy, and inexpensive determination of every action and proceeding.”

These Guidelines also promote, when ripe, the early resolution of disputes regarding the discovery of ESI without Court intervention.

Guideline 1.02 (Cooperation)

The Court expects cooperation on issues relating to the preservation, collection, search, review, and production of ESI. The Court notes that an attorney’s zealous representation of a client is not compromised by conducting discovery in a cooperative manner. Cooperation in reasonably limiting ESI discovery requests on the one hand, and in reasonably responding to ESI discovery requests on the other hand, tends to reduce litigation costs and delay. The Court emphasizes the particular importance of cooperative exchanges of information at the earliest possible stage of discovery, including during the parties’ Fed. R. Civ. P. 26(f) conference.

Guideline 1.03 (Discovery Proportionality)

The proportionality standard set forth in Fed. R. Civ. P. 26(b)(2)(C) and 26(g)(1)(B)(iii) should be applied to the discovery plan and its elements, including the preservation, collection, search, review, and production of ESI. To assure reasonableness and proportionality in discovery, parties should consider factors that include the burden or expense of the proposed discovery compared to its likely benefit, the amount in controversy, the parties’ resources, the importance of the issues at stake in the action, and the importance of the discovery in adjudicating the merits of the case.

To further the application of the proportionality standard, discovery requests for production of ESI and related responses should be reasonably targeted, clear, and as specific as practicable.

ESI DISCOVERY GUIDELINES

Guideline 2.01 (Preservation)

a) At the outset of a case, or sooner if feasible, counsel for the parties should discuss preservation. Such discussions should continue to occur periodically as the case and issues evolve.

b) In determining what ESI to preserve, parties should apply the proportionality standard referenced in Guideline 1.03. The parties should strive to define a scope of preservation that is proportionate and reasonable and not disproportionately broad, expensive, or burdensome.

c) Parties are not required to use preservation letters to notify an opposing party of the preservation obligation, but if a party does so, the Court discourages the use of overbroad preservation letters. Instead, if a party prepares a preservation letter, the letter should provide as much detail as possible, such as the names of parties, a description of claims, potential witnesses, the relevant time period, sources of ESI the party knows or believes are likely to contain relevant information, and any other information that might assist the responding party in determining what information to preserve.

d) If there is a dispute concerning the scope of a party's preservation efforts, the parties or their counsel should meet and confer and fully discuss the reasonableness and proportionality of the preservation. If the parties are unable to resolve a preservation issue, then the issue should be raised promptly with the Court.

e) The parties should discuss what ESI from sources that are not reasonably accessible will be preserved, but not searched, reviewed, or produced. As well as discussing ESI sources that are not reasonably accessible, the parties should consider identifying data from sources that (1) the parties believe could contain relevant information but (2) determine, under the proportionality factors, should not be preserved.

Guideline 2.02 (Rule 26(f) Meet and Confer)

At the required Rule 26(f) meet and confer conference, when a case involves electronic discovery, the topics that the parties should consider discussing include: 1) preservation; 2) systems that contain discoverable ESI; 3) search and production; 4) phasing of discovery; 5) protective orders; and 6) opportunities to reduce costs and increase efficiency. In order to be meaningful, the meet and confer should be as sufficiently detailed on these topics as is appropriate in light of the specific claims and defenses at issue in the case. Some or all of the following details may be useful to discuss, especially in cases where the discovery of ESI is likely to be a significant cost or burden:

a) The sources, scope and type of ESI that has been and will be preserved -- considering the needs of the case and other proportionality factors-- including date

ranges, identity and number of potential custodians, and other details that help clarify the scope of preservation;

- b) Any difficulties related to preservation;
- c) Search and production of ESI, such as any planned methods to identify discoverable ESI and filter out ESI that is not subject to discovery, or whether ESI stored in a database can be produced by querying the database and producing discoverable information in a report or an exportable electronic file;
- d) The phasing of discovery so that discovery occurs first from sources most likely to contain relevant and discoverable information and is postponed or avoided from sources less likely to contain relevant and discoverable information;
- e) The potential need for a protective order and any procedures to which the parties might agree for handling inadvertent production of privileged information and other privilege waiver issues pursuant to Fed. R. Evid. 502(d) or (e), including a Rule 502(d) Order;
- f) Opportunities to reduce costs and increase efficiency and speed, such as by conferring about the methods and technology used for searching ESI to help identify the relevant information and sampling methods to validate the search for relevant information, using agreements for truncated or limited privilege logs, or by sharing expenses like those related to litigation document repositories.

The Court encourages the parties to address any agreements or disagreements related to the above matters in the joint case management statement required by Civil Local Rule 16-9.

Guideline 2.03 (Cooperation and Informal Discovery Regarding ESI)

The Court strongly encourages an informal discussion about the discovery of ESI (rather than deposition) at the earliest reasonable stage of the discovery process. Counsel, or others knowledgeable about the parties' electronic systems, including how potentially relevant data is stored and retrieved, should be involved or made available as necessary. Such a discussion will help the parties be more efficient in framing and responding to ESI discovery issues, reduce costs, and assist the parties and the Court in the event of a dispute involving ESI issues.

Guideline 2.04 (Disputes Regarding ESI Issues)

Disputes regarding ESI that counsel for the parties are unable to resolve shall be presented to the Court at the earliest possible opportunity, such as at the initial Case Management Conference. If the Court determines that any counsel or party in a case has failed to cooperate and participate in good faith in the meet and confer process, the Court may require additional meet and confer discussions, if appropriate.

Guideline 2.05 (E-Discovery Liaison(s))

In most cases, the meet and confer process will be aided by participation of e-discovery liaisons as defined in this Guideline. If a dispute arises that involves the technical aspects of e-discovery, each party shall designate an e-discovery liaison who will be knowledgeable about and responsible for discussing their respective ESI. An e-

discovery liaison will be, or have access to those who are, knowledgeable about the location, nature, accessibility, format, collection, searching, and production of ESI in the matter. Regardless of whether the e-discovery liaison is an attorney (in-house or outside counsel), an employee of the party, or a third party consultant, the e-discovery liaison should:

- a) Be prepared to participate in e-discovery dispute resolution to limit the need for Court intervention;
- b) Be knowledgeable about the party's e-discovery efforts;
- c) Be familiar with, or gain knowledge about, the party's electronic systems and capabilities in order to explain those systems and answer related questions; and
- d) Be familiar with, or gain knowledge about, the technical aspects of e-discovery in the matter, including electronic document storage, organization, and format issues, and relevant information retrieval technology, including search methodology.

EDUCATION GUIDELINES

Guideline 3.01 (Judicial Expectations of Counsel)

It is expected that counsel for the parties, including all counsel who have appeared, as well as all others responsible for making representations to the Court or opposing counsel (whether or not they make an appearance), will be familiar with the following in each litigation matter:

(a) The electronic discovery provisions of the Federal Rules of Civil Procedure, including Rules 26, 33, 34, 37, and 45, and Federal Rule of Evidence 502;

(b) The Advisory Committee Report on the 2006 Amendments to the Federal Rules of Civil Procedure, available at uscourts.gov/uscourts/RulesAndPolicies/rules/Reports/CV5-2005.pdf; and

(c) These Guidelines and this Court's *Checklist for Rule 26(f) Meet and Confer Regarding ESI and Stipulated E-Discovery Order for Standard Litigation*.

UNITED STATES DISTRICT COURT

NORTHERN DISTRICT OF CALIFORNIA

Plaintiff(s),)	Case Number: C xx-xxxx
)	[MODEL] STIPULATION & ORDER RE:
vs.)	DISCOVERY OF ELECTRONICALLY
)	STORED INFORMATION FOR
Defendant(s).)	PATENT LITIGATION
)	

Upon the stipulation of the parties, the Court ORDERS as follows:

1. This Order supplements all other discovery rules and orders. It streamlines Electronically Stored Information (“ESI”) production to promote a “just, speedy, and inexpensive determination of this action, as required by Federal Rule of Civil Procedure 1.”

2. This Order may be modified in the Court’s discretion or by stipulation. The parties shall jointly submit any proposed modifications within 30 days after the Federal Rule of Civil Procedure 16 Conference.

3. As in all cases, costs may be shifted for disproportionate ESI production requests pursuant to Federal Rule of Civil Procedure 26. Likewise, a party’s nonresponsive or dilatory discovery tactics are cost-shifting considerations.

4. A party’s meaningful compliance with this Order and efforts to promote efficiency and reduce costs will be considered in cost-shifting determinations.

5. The parties are expected to comply with the District’s E-Discovery Guidelines (“Guidelines”) and are encouraged to employ the District’s Model Stipulated Order Re: the Discovery of Electronically Stored Information and Checklist for Rule 26(f) Meet and Confer regarding Electronically Stored Information.

6. General ESI production requests under Federal Rules of Civil Procedure 34 and 45 shall not include email or other forms of electronic correspondence (collectively “email”). To obtain email parties must propound specific email production requests.

7. Email production requests shall only be propounded for specific issues, rather than general discovery of a product or business.

8. Email production requests shall be phased to occur after the parties have exchanged initial disclosures and basic documentation about the patents, the prior art, the accused instrumentalities, and the relevant finances. While this provision does not require the production of such information, the Court encourages prompt and early production of this information to promote efficient and economical streamlining of the case.

9. Email production requests shall identify the custodian, search terms, and time frame. The parties shall cooperate to identify the proper custodians, proper search terms and proper timeframe as set forth in the Guidelines.

10. Each requesting party shall limit its email production requests to a total of five custodians per producing party for all such requests. The parties may jointly agree to modify this limit without the Court's leave. The Court shall consider contested requests for additional custodians, upon showing a distinct need based on the size, complexity, and issues of this specific case. Cost-shifting may be considered as part of any such request.

11. Each requesting party shall limit its email production requests to a total of five search terms per custodian per party. The parties may jointly agree to modify this limit without the Court's leave. The Court shall consider contested requests for additional search terms per custodian, upon showing a distinct need based on the size, complexity, and issues of this specific case. The Court encourages the parties to confer on a process to test the efficacy of the search terms. The search terms shall be narrowly tailored to particular issues. Indiscriminate terms, such as the producing company's name or its product name, are inappropriate unless combined with narrowing search criteria that sufficiently reduce the risk of overproduction. A conjunctive combination of multiple words or phrases (*e.g.*, "computer" and "system") narrows the search and shall count as a single search term. A disjunctive combination of multiple words or phrases (*e.g.*, "computer" or "system") broadens the search, and thus each word or phrase shall count as a separate search term unless they are variants of the same word. Use of narrowing search criteria (*e.g.*, "and," "but not," "w/x") is encouraged to limit the production and shall be considered when determining whether to shift costs for disproportionate discovery. Should a party serve email production requests with search terms beyond the limits agreed to by the parties or granted by the Court pursuant to this paragraph, this shall be considered in determining whether any party shall bear all reasonable costs caused by such additional discovery.

12. Nothing in this Order prevents the parties from agreeing to use technology assisted review and other techniques insofar as their use improves the efficacy of discovery. Such topics should be discussed pursuant to the District's E-Discovery Guidelines.

IT IS SO STIPULATED, through Counsel of Record.

Dated:

Counsel for Plaintiff

Dated:

Counsel for Defendant

IT IS ORDERED that the foregoing Agreement is approved.

Dated:

UNITED STATES DISTRICT/MAGISTRATE JUDGE

District of Delaware
United States District Court

**DEFAULT STANDARD FOR DISCOVERY,
INCLUDING DISCOVERY OF ELECTRONICALLY STORED
INFORMATION (“ESI”)**

I. General Provisions

a. **Cooperation.** Parties are expected to reach agreements cooperatively on how to conduct discovery under Fed. R. Civ. P. 26-36. In the event that the parties are unable to agree on the parameters and/or timing of discovery, the following default standards shall apply until further order of the Court or the parties reach agreement.

b. **Proportionality.** Parties are expected to use reasonable, good faith and proportional efforts to preserve, identify and produce relevant information.⁶ This includes identifying appropriate limits to discovery, including limits on custodians, identification of relevant subject matter, time periods for discovery and other parameters to limit and guide preservation and discovery issues.

c. **Preservation of Discoverable Information.** A party has a common law obligation to take reasonable and proportional steps to preserve discoverable information in the party’s possession, custody or control.

(i) Absent a showing of good cause by the requesting party, the parties shall not be required to modify, on a going-forward basis, the procedures used by them in the ordinary course of business to back up and archive data; provided, however, that the parties shall preserve the non-duplicative discoverable information currently in their possession, custody or control.

(ii) Absent a showing of good cause by the requesting party, the categories of ESI identified in Schedule A attached hereto need not be preserved.

d. Privilege.

(i) The parties are to confer on the nature and scope of privilege logs for the case, including whether categories of information may be excluded from any logging requirements and whether alternatives to document-by-document logs can be exchanged.

(ii) With respect to information generated after the filing of the complaint, parties are not required to include any such information in privilege logs.

(iii) Activities undertaken in compliance with the duty to preserve information are protected from disclosure and discovery under Fed. R. Civ. P. 26(b)(3)(A) and (B).

(iv) Parties shall confer on an appropriate non-waiver order under Fed. R. Evid. 502. Until a non-waiver order is entered, information that con-

6. Information can originate in any form, including ESI and paper, and is not limited to information created or stored electronically.

tains privileged matter or attorney work product shall be immediately returned if such information appears on its face to have been inadvertently produced or if notice is provided within 30 days of inadvertent production.

2. Initial Discovery Conference.

a. **Timing.** Consistent with the guidelines that follow, the parties shall discuss the parameters of their anticipated discovery at the initial discovery conference (the “Initial Discovery Conference”) pursuant to Fed. R. Civ. P. 26(f), which shall take place before the Fed. R. Civ. P. 16 scheduling conference (“Rule 16 Conference”).

b. **Content.** The parties shall discuss the following:

(i) The issues, claims and defenses asserted in the case that define the scope of discovery.

(ii) The likely sources of potentially relevant information (i.e., the “discoverable information”), including witnesses, custodians and other data sources (e.g., paper files, email, databases, servers, etc.).

(iii) Technical information, including the exchange of production formats.

(iv) The existence and handling of privileged information.

(v) The categories of ESI that should be preserved.

3. Initial Disclosures. Within 30 days after the Rule 16 Conference, each party shall disclose:

a. **Custodians.** The 10 custodians most likely to have discoverable information in their possession, custody or control, from the most likely to the least likely. The custodians shall be identified by name, title, role in the instant dispute, and the subject matter of the information.

b. **Non-custodial data sources.**⁷ A list of the non-custodial data sources that are most likely to contain non-duplicative discoverable information for preservation and production consideration, from the most likely to the least likely.

c. **Notice.** The parties shall identify any issues relating to:

(i) Any ESI (by type, date, custodian, electronic system or other criteria) that a party asserts is not reasonably accessible under Fed. R. Civ. P. 26(b)(2)(C)(i).

(ii) Third-party discovery under Fed. R. Civ. P. 45 and otherwise, including the timing and sequencing of such discovery.

(iii) Production of information subject to privacy protections, including information that may need to be produced from outside of the United States and subject to foreign laws.

7. That is, a system or container that stores ESI, but over which an individual custodian does not organize, manage, or maintain the ESI in the system or container (e.g., enterprise system or database).

Lack of proper notice of such issues may result in a party losing the ability to pursue or to protect such information.

4. Initial Discovery in Patent Litigation.⁸

a. Within 30 days after the Rule 16 Conference and for each defendant,⁹ the plaintiff shall specifically identify the accused products¹⁰ and the asserted patent(s) they allegedly infringe, and produce the file history for each asserted patent.

b. Within 30 days after receipt of the above, each defendant shall produce to the plaintiff the core technical documents related to the accused product(s), including but not limited to operation manuals, product literature, schematics, and specifications.

c. Within 30 days after receipt of the above, plaintiff shall produce to each defendant an initial claim chart relating each accused product to the asserted claims each product allegedly infringes.

d. Within 30 days after receipt of the above, each defendant shall produce to the plaintiff its initial invalidity contentions for each asserted claim, as well as the related invalidating references (e.g., publications, manuals and patents).

e. Absent a showing of good cause, follow-up discovery shall be limited to a term of 6 years before the filing of the complaint, except that discovery related to asserted prior art or the conception and reduction to practice of the inventions claimed in any patent-in-suit shall not be so limited.

5. Specific E-Discovery Issues.

a. **On-site inspection of electronic media.** Such an inspection shall not be permitted absent a demonstration by the requesting party of specific need and good cause.

b. **Search methodology.** If the producing party elects to use search terms to locate potentially responsive ESI, it shall disclose the search terms to the requesting party. Absent a showing of good cause, a requesting party may request no more than 10 additional terms to be used in connection with the electronic search. Focused terms, rather than overbroad terms (e.g., product and company names), shall be employed. The producing party shall search (i) the non-custodial data sources identified in accordance with paragraph 3(b); and (ii) emails and other ESI maintained by the custodians identified in accordance with paragraph 3(a).

c. **Format.** ESI and non-ESI shall be produced to the requesting party as text searchable image files (e.g., PDF or TIFF). When a text-searchable image file is produced, the producing party must preserve the integrity of the underlying ESI, i.e., the original formatting, the metadata (as noted below) and, where applicable,

8. As these disclosures are “initial,” each party shall be permitted to supplement.

9. For ease of reference, “defendant” is used to identify the alleged infringer and “plaintiff” to identify the patentee.

10. For ease of reference, the word “product” encompasses accused methods and systems as well.

the revision history. The parties shall produce their information in the following format: single page TIFF images and associated multipage text files containing extracted text or OCR with Concordance and Opticon load files containing all requisite information including relevant metadata.

d. **Native files.** The only files that should be produced in native format are files not easily converted to image format, such as Excel and Access files.

e. **Metadata fields.** The parties are only obligated to provide the following metadata for all ESI produced, to the extent such metadata exists: Custodian, File Path, Email Subject, Conversation Index, From, To, CC, BCC, Date Sent, Time Sent, Date Received, Time Received, Filename, Author, Date Created, Date Modified, MD5 Hash, File Size, File Extension, Control Number Begin, Control Number End, Attachment Range, Attachment Begin, and Attachment End (or the equivalent thereof).

SCHEDULE A

1. Deleted, slack, fragmented, or other data only accessible by forensics.
2. Random access memory (RAM), temporary files, or other ephemeral data that are difficult to preserve without disabling the operating system.
3. On-line access data such as temporary internet files, history, cache, cookies, and the like.
4. Data in metadata fields that are frequently updated automatically, such as last-opened dates.
5. Back-up data that are substantially duplicative of data that are more accessible elsewhere.
6. Voice messages.
7. Instant messages that are not ordinarily printed or maintained in a server dedicated to instant messaging.
8. Electronic mail or pin-to-pin messages sent to or from mobile devices (e.g., iPhone and Blackberry devices), provided that a copy of such mail is routinely saved elsewhere.
9. Other electronic data stored on a mobile device, such as calendar or contact data or notes, provided that a copy of such information is routinely saved elsewhere.
10. Logs of calls made from mobile devices.
11. Server, system or network logs.
12. Electronic data temporarily stored by laboratory equipment or attached electronic equipment, provided that such data is not ordinarily preserved as part of a laboratory report.
13. Data remaining from systems no longer in use that is unintelligible on the systems in use.

THE UNITED STATES DISTRICT COURT FOR THE
DISTRICT OF KANSAS

GUIDELINES FOR CASES INVOLVING
ELECTRONICALLY STORED INFORMATION [ESI]

These guidelines are intended to facilitate compliance with the provisions of Fed. R. Civ. P. 1, 16, 26, 33, 34, 37, and 45 relating to the discovery of electronically stored information (“ESI”) and the current applicable case law. In the case of any asserted conflict between these guidelines and either the referenced rules or applicable case law, the latter should control.

INTRODUCTION

1. Purpose

The purpose of these guidelines is to facilitate the just, speedy, and inexpensive resolution of disputes involving ESI, and to promote, whenever possible, the resolution of disputes regarding the discovery of ESI without Court intervention. Parties should consider the proportionality principle inherent within the Federal Rules in using these guidelines. *See* Fed. R. Civ. P. 26(b)(2)(C)(iii) and 26(g)(1)(B)(iii).

2. Principle of Cooperation

An attorney’s representation of a client is improved by conducting discovery in a cooperative manner. The failure of counsel or the parties in litigation to cooperate in facilitating and reasonably limiting discovery requests and responses increases litigation costs and contributes to the risk of sanctions. For a more complete discussion of this principle, please review the Sedona Conference Cooperation Proclamation¹ endorsed by seven judges² from Kansas and “Cooperation — What Is It and Why Do It?” by David J. Waxse.³

1. <http://www.thesedonaconference.org/dltForm?did=proclamation.pdf>

2. Hon. Gerald J. Elliott, Johnson County District Court, Olathe, Hon. Kenneth Gale, U.S. District Court for the District of Kansas, Wichita, Hon. Karen M. Humphreys, U.S. District Court for the District of Kansas, Wichita, Hon. J. Thomas Marten, U.S. District Court for the District of Kansas, Wichita, Hon. James P. O’Hara, U.S. District Court for the District of Kansas, Kansas City, Hon. Gerald L. Rushfelt, U.S. District Court for the District of Kansas, Kansas City, Hon. K. Gary Sebelius, U.S. District Court for the District of Kansas, Topeka, Hon. David Waxse, U.S. District Court for the District of Kansas, Kansas City.

3. <http://jolt.richmond.edu.v18i3/article8.pdf>

4. <https://thesedonaconference.org/publication/The%20Sedona%20Conference%20Glossary>.

DEFINITIONS

3. General

To avoid misunderstandings about terms, all parties should consult the most current edition of The Sedona Conference® Glossary⁴ and “The Grossman-Cormack Glossary of Technology-Assisted Review.”⁵ In addition, references in these guidelines to counsel include parties who are not represented by counsel.

4. Form of Production

Parties and counsel should recognize the distinction between format and media. Format, the internal structure of the data, suggests the software needed to create and open the file (i.e., an Excel spreadsheet, a Word document, a PDF file). Media refers to the hardware containing the file (i.e., a flash drive or disc). Electronic documents have an associated file structure defined by the original creating application. This file structure is referred to as the “native format” of the document.⁶

Native format refers to the document’s internal structure at the time of the creation. In general, a file maintained in native format includes any metadata embedded inside the document that would otherwise be lost by conversion to another format or hard copy. In contrast, a “static format,” such as a .PDF or .TIF, creates an image of the document as it originally appeared in native format but usually without retaining any metadata. Counsel need to be clear as to what they want and what they are producing.

Counsel should know the format of the file and, if counsel does not know how to read the file format, should consult with an expert as necessary to determine the software programs required to read the file format.

5. Meta and Embedded Data

“Metadata” typically refers to information describing the history, tracking, or management of an electronic file. Some forms of metadata are maintained by the system to describe the file’s author, dates of creation and modification, location on the drive, and filename. Other examples of metadata include spreadsheet formulas, database structures, and other details which, in a given context, could prove critical to understanding the information contained in the file. “Embedded data” typically refers to draft language, editorial comments, and other deleted or linked matter retained by computer programs.

5. Federal Courts Law Review, Vol. 7, Issue 1 (2013).

6. <http://www.thesedonaconference.org/dltForm?did=glossary2010.pdf>.

Metadata and embedded data may contain privileged or protected information. Litigants should be aware of metadata and embedded data when reviewing documents but should refrain from “scrubbing” either metadata or embedded data without cause or agreement of adverse parties.

PRIOR TO THE FILING OF LITIGATION

6. Identification of Potential Parties and Issues

When there is a reasonable anticipation of litigation or when litigation is imminent⁷, efforts should be made to identify potential parties and their counsel to that litigation to facilitate early cooperation in the preservation and exchange of relevant electronically stored information. To comply with Fed. R. Civ. P. 26(b)(1) scope of discovery “regarding any nonprivileged matter that is relevant to any party’s claim or defense,” counsel should consider determining the issues that will likely arise in the litigation. They should also consider discussing with opposing counsel which issues are actually in dispute and which can be resolved by agreement. Agreement that an issue is not disputed can reduce discovery costs.

7. Identification of Electronically Stored Information

In anticipation of litigation, counsel should become knowledgeable about their client’s information management systems and its operation, including how information is stored and retrieved. Counsel should also consider determining whether discoverable ESI is being stored by third parties for example in cloud storage facilities or social media. In addition, counsel should make a reasonable attempt to review their client’s relevant and/or discoverable ESI to ascertain the contents, including backup, archival and legacy data (outdated formats or media).

8. Preservation

In general, electronic files are usually preserved in native format with metadata intact. Every party either reasonably anticipating litigation or believing litigation is imminent⁸ must take reasonable and proportionate steps to preserve relevant and discoverable ESI within its possession, custody or control.⁹ Determining which steps are reasonable and proportionate in particular litigation is a fact specific inquiry that will vary from case to case. The parties and

7. The Tenth Circuit has not yet addressed the relevant standard on when parties should take action regarding ESI prior to litigation being initiated but has said action should have been taken when litigation is “imminent” in the general litigation context. Judges in the District of Kansas have used both that standard and the standard of when litigation is “reasonably anticipated” in the context of litigation involving ESI.

8. *Ibid* p.2.

9 Counsel should become aware of the current 10th Circuit law defining “possession, custody and control.”

counsel should address preservation issues immediately, and should continue to address them as the case progresses and their understanding of the issues and the facts improves. If opposing parties and counsel can be identified, efforts should be made to reach agreement on preservation issues. The parties and counsel should consider the following:

- (a) The categories of potentially discoverable information to be segregated and preserved;
- (b) The “key persons” and likely witnesses and persons with knowledge regarding relevant events;
- (c) The relevant time period for the litigation hold;
- (d) The nature of specific types of ESI, including email and attachments, word processing documents, spreadsheets, graphics and presentation documents, images, text files, hard drives, databases, instant messages, transaction logs, audio and video files, voicemail, Internet data, computer logs, text messages, or backup materials, and native files, and how it should be preserved.
- (e) Data maintained by third parties, including data stored in social media and cloud servers. Because of the dynamic nature of social media, preservation of this data may require the use of additional tools and expertise.

INITIATION OF LITIGATION

9. Narrowing the Issues

After litigation has begun, counsel should attempt to narrow the issues early in the litigation process by review of the pleadings and consultation with opposing counsel. Through discussion, counsel should identify the material factual issues that will require discovery. Counsel should engage with opposing counsel in a respectful, reasonable, and good faith manner, with due regard to the mandate of Rule 1 that the rules “should be construed and administered to secure the just, speedy, and inexpensive determination of every action and proceeding.” In addition, counsel should comply with their professional and ethical obligations including candor to the court and opposing counsel. Note that the issues discussed will need to be revisited throughout the litigation.

10. E-Discovery Liaison

To promote communication and cooperation between the parties, each party to a case with significant e-discovery issues may designate an e-discovery liaison for purposes of assisting counsel, meeting, conferring, and attending court hearings on the subject. Regardless of whether the liaison is an attorney (in-house or outside counsel), a third party consultant, or an employee of the party, he or she should be:

- Familiar with the party's electronic information systems and capabilities in order to explain these systems and answer relevant questions.
- Knowledgeable about the technical aspects of e-discovery, including the storage, organization, and format issues relating to electronically stored information.
- Prepared to participate in e-discovery dispute resolutions.

The attorneys of record are responsible for compliance with e-discovery requests and, if necessary, for obtaining a protective order to maintain confidentiality while facilitating open communication and the sharing of technical information. However, the liaison should be responsible for organizing each party's e-discovery efforts to insure consistency and thoroughness and, generally, to facilitate the e-discovery process.

AT THE RULE 26(f) CONFERENCES

11. **General**

At the Rule 26(f) conference or prior to the conference if possible, a party seeking discovery of ESI should notify the opposing party of that fact immediately, and, if known at that time, should identify as clearly as possible the categories of information that may be sought. Parties and counsel are reminded that, under Fed. R. Civ. P. 34, if the requesting party has not designated a form of production in its request, or if the responding party objects to the designated form, then the responding party must state in its written response the form it intends to use for producing ESI. In cases with substantial ESI issues, counsel should assume that this discussion will be an ongoing process and not a onetime meeting.¹⁰

12. **Reasonably Accessible Information and Costs**

- a. The volume of, and ability to search, ESI means that most parties' discovery needs will be satisfied from reasonably accessible sources. Counsel should attempt to determine if any responsive ESI is not reasonably accessible, i.e., information that is only accessible by incurring undue burdens or costs. If the responding party is not searching or does not plan to search sources containing potentially responsive information, it should identify the category or type of

10. For a more detailed description of matters that may need to be discussed, see Craig Ball, *Ask and Answer to Right Questions in EDD*, LAW TECHNOLOGY NEWS, Jan. 4, 2008, accessed on Feb. 1, 2008 at <http://www.law.com/jsp/ihc/PubArticleIHC.jsp?id=1199441131702#> and reprinted in these Guidelines with permission at Appendix 1.

such information. If the requesting party intends to seek discovery of ESI from sources identified as not reasonably accessible, the parties should discuss: (1) the burden and cost of accessing and retrieving the information, (2) the needs that may establish good cause for requiring production of all or part of the information, even if the information sought is not reasonably accessible, and (3) conditions on obtaining and producing this information such as scope, time, and allocation of cost.

- b. Absent a contrary showing of good cause, *e.g.*, Fed. R. Civ. P. 26(b)(2)(c), the parties should generally presume that the producing party will bear all costs for reasonably accessible ESI. The parties should generally presume that there will be cost sharing or cost shifting for ESI that is not reasonably accessible.

13. Creation of a Shared Database and Use of One Search Protocol

In appropriate cases counsel may want to attempt to agree on the construction of a shared database, accessible and searchable by both parties. In such cases, they should consider both hiring a neutral vendor and/or using one search protocol with a goal of minimizing the costs of discovery for both sides.¹¹

14. Removing Duplicated Data and De-NISTing

Counsel should discuss the elimination of duplicative ESI and whether such elimination will occur only within each particular custodian's data set or whether it will occur across all custodians, also known as vertical and horizontal views of ESI.

In addition, counsel should discuss the de-NISTing of files which is the use of an automated filter program that screens files against the NIST list of computer file types to separate those generated by a system and those generated by a user. [NIST (National Institute of Standards and Technology) is a federal agency that works with industry to develop technology measurements and standards.] NIST developed a hash database of computer files to identify files that are system generated and generally accepted to have no substantive value in most cases.¹²

15. Search Methodologies

If counsel intend to employ technology assisted review¹³ (TAR) to locate relevant ESI and privileged information, counsel should attempt to reach agree

11. Vice Chancellor Travis Laster ordered counsel to use the same search protocol in *EORHB, Inc. v. HOA Holdings, LLC*, C.A. No. 7409-VCL (Del. Ch. Oct. 15, 2012). He later modified his order. See 2013 WL 1960621 (Del. Ch. May 6, 2013).

12. <http://www.thesedonaconference.org/dltForm?did=glossary2010.pdf>

13. "The Grossman-Cormack Glossary of Technology-Assisted Review.

ment about the method of searching or the search protocol. TAR is a process for prioritizing or coding a collection of documents using a computerized system that harnesses human judgments of one or more subject matter expert(s) on a smaller set of documents and then extrapolates those judgments to the remaining document collection.¹⁴

If word searches are to be used, the words, terms, and phrases to be searched should be determined with the assistance of the respective e-discovery liaisons, who are charged with familiarity with the parties' respective systems. In addition, any attempt to use word searches should be based on words that have been tested against a randomly selected sample of the data being searched.

Counsel also should attempt to reach agreement as to the timing and conditions of any searches which may become necessary in the normal course of discovery. To minimize the expense, counsel may consider limiting the scope of the electronic search (e.g., time frames, fields, document types) and sampling techniques to make the search more effective.

16. E-Mail

Counsel should attempt to agree on the scope of e-mail discovery and e-mail search protocol. The scope of e-mail discovery may require determining whether the unit for production should focus on the immediately relevant e-mail or the entire string that contains the relevant e-mail.

In addition, counsel should focus on the privilege log ramifications of selecting a particular unit of production.¹⁵

17. Deleted Information

Counsel should attempt to agree on whether responsive deleted information still exists, the extent to which restoration of deleted information is needed, and who will bear the costs of restoration.

14. There is no current agreement on what to call the searches that are performed with the assistance of technology. Some currently used other terms include: (CAR) computer assisted review, predictive coding, concept search, contextual search, boolean search, fuzzy search and others.

15. *In re Universal Service Fund Telephone Billing Practices Litigation*, 232 F.R.D. 669, 674 (D. Kan. 2005).

18. Meta and Embedded Data

Counsel should discuss whether “embedded data” and “metadata” exist, whether it will be requested or should be produced, and how to handle determinations regarding privilege or protection of trial preparation materials.

19. Data Possessed by Third Parties

Counsel should attempt to agree on an approach to ESI stored by third parties. This includes files stored on a cloud server or social networking data on services like Facebook, Twitter, and MySpace.

20. Format and Media

The parties have discretion to determine production format and should cooperate in good faith to promote efficiencies. Reasonable requests for production of particular documents in native format with metadata intact should be considered.

21. Identifying Information

Because identifying information may not be placed on ESI as easily as bates stamping paper documents, methods of identifying pages or segments of ESI produced in discovery should be discussed.¹⁶ Counsel are encouraged to discuss the use of either a digital notary, hash value indices or other similar methods for producing native files.

22. Priorities and Sequencing

Counsel should attempt to reach an agreement on the sequence of processing data for review and production. Some criteria to consider include ease of access or collection, sources of data, date ranges, file types, and keyword matches. Counsel should attempt to reach an agreement regarding what will happen in the event of inadvertent disclosure of privileged or trial preparation materials.¹⁷ If the disclosing party inadvertently produces privileged or trial preparation materials, it must notify the requesting party of such disclosure. After the requesting party is notified, it must return, sequester, or destroy all information and copies and may not use or disclose this information until the claim of privilege or protection as trial preparation materials is resolved.

16. For a viable electronic alternative to bates stamps, see Ralph C. Losey, *HASH: The New Bates Stamp*, 12 J. Tech. L. & Pol’y 1 (2007).

17. In addition counsel should comply with current rules and case law on the requirement of creating privilege logs.

23. Privilege

- A. To accelerate the discovery process, the parties may establish a “clawback agreement,” whereby materials that are disclosed without intent to waive privilege or protection are not waived and are returned to the responding party, so long as the responding party identifies the materials mistakenly produced. Counsel should be aware of the requirements of Federal Rule of Evidence 502(d) to protect against waivers of privilege in other settings.
- B. The parties may agree to provide a “quick peek,” whereby the responding party provides certain requested materials for initial examination without waiving any privilege or protection.

Other voluntary agreements should be considered as appropriate. Counsel should be aware that there is an issue of whether such agreements bind third parties who are not parties to the agreements. The Court may enter a clawback arrangement for good cause even if there is no agreement. In that case, third parties may be bound but only pursuant to the court order.¹⁸

DISCOVERY PROCESS

24. Timing

Counsel should attempt to agree on the timing and sequencing of e-discovery. In general, e-discovery should proceed in the following order.

(a) Mandatory Disclosure

Disclosures pursuant to Fed. R. Civ. P. 26(a)(1) must include any ESI that the disclosing party may use to support its claims or defenses (unless used solely for impeachment). To determine what information must be disclosed pursuant to this rule, counsel should review, with their clients, the client’s ESI files, including current, back-up, archival, and legacy computer files. Counsel should be aware that documents in paper form may have been generated by the client’s information system; thus, there may be ESI related to that paper document. If any party intends to disclose ESI, counsel should identify those individuals with knowledge of their client’s electronic information systems who can facilitate the location and identification of discoverable ESI prior to the Fed. R. Civ. P. 26(f) conference.

18. See *Rajala v. McGuire Woods, LLP*, No. 08-2638-CM-DJW, 2010 WL 2949582 (D. Kan. July 22, 2010).

(b) Search of Reasonably Accessible Information

After receiving requests for production under Fed. R. Civ. P. 34, the parties shall search their electronically stored information, other than that identified as not reasonably accessible due to undue burden and/or substantial cost, and produce responsive information in accordance with Fed. R. Civ. P. 26(b).

(c) Search of Unreasonably Accessible Information

Electronic searches of information identified as not reasonably accessible should not be conducted until the initial search has been completed and then only by agreement of the parties or pursuant to a court order. Requests for electronically stored information that is not reasonably accessible must be narrowly focused with good cause supporting the request. See Fed. R. Civ. P. 26(b)(2), Advisory Committee Notes, December 2006 Amendment (good cause factors).

(d) Requests for On-Site Inspections

Requests for on-site inspections of electronic media under Fed. R. Civ. P. 34(b) should be reviewed to determine if good cause and specific need have been demonstrated.

25. Discovery Concerning Preservation and Collection Efforts

Discovery concerning the preservation and collection efforts of another party, if used unadvisedly, can contribute to unnecessary expense and delay and may inappropriately implicate work product and attorney-client privileged matter. Routine discovery into such matters is therefore strongly discouraged and may be in violation of Fed. R. Civ. P. 26(g)'s requirement that discovery be "neither unreasonable nor unduly burdensome or expensive". Prior to initiating any such discovery, counsel shall confer with counsel for the party from whom the information is sought concerning: (i) the specific need for such discovery, including its relevance to issues likely to arise in the litigation; and (ii) the suitability of alternative means for obtaining the information. Discovery into such matters may be compelled only on a showing of good cause considering at least the aforementioned factors. Nothing herein exempts deponents on merits issues from answering questions concerning the preservation and collection of their documents, ESI, and tangible things.

26. Duty to Meet and Confer When Requesting ESI from Nonparties (Fed. R. Civ. P. 45)

Counsel issuing requests for ESI from nonparties should attempt to informally meet and confer with the non-party (or counsel, if represented). During this

Chapter 4: Discovery

meeting, counsel should discuss the same issues regarding ESI requests that they would with opposing counsel as set forth in Paragraph 11 above.

July 18, 2013

APPENDIX 1

Ask and Answer the Right Questions in EDD

Craig Ball, *Law Technology News* (Jan. 4, 2008)

Sometimes it's more important to ask the right questions than to know the right answers, especially when it comes to nailing down sources of electronically stored information, preservation efforts and plans for production in the FRCP Rule 26(f) conference, the so-called "meet and confer."

The federal bench is deadly serious about meet and confers, and heavy boots have begun to meet recalcitrant behinds when Rule 26(f) encounters are perfunctory, drive-by events. Enlightened judges see that meet and confers must evolve into candid, constructive mind melds if we are to take some of the sting and "gotcha" out of e-discovery. Meet and confer requires intense preparation built on a broad and deep gathering of detailed information about systems, applications, users, issues and actions. An hour or two of hard work should lie behind every minute of a Rule 26(f) conference. Forget "winging it" on charm or bluster and forget "We'll get back to you on that."

Here are 50 questions of the sort I think should be hashed out in a Rule 26(f) conference. If you think asking them is challenging, think about what's required to deliver answers you can certify in court. It's going to take considerable arm-twisting by the courts to get lawyers and clients to do this much homework and master a new vocabulary, but, there is no other way.

These 50 aren't all the right questions for you to pose to your opponent, but there's a good chance many of them are . . . and a likelihood you'll be in the hot seat facing them, too.

1. What are the issues in the case?
2. Who are the key players in the case?
3. Who are the persons most knowledgeable about ESI systems?
4. What events and intervals are relevant?
5. When did preservation duties and privileges attach?
6. What data are at greatest risk of alteration or destruction?
7. Are systems slated for replacement or disposal?
8. What steps have been or will be taken to preserve ESI?
9. What third parties hold information that must be preserved, and who will notify them?
10. What data require forensically sound preservation?
11. Are there unique chain-of-custody needs to be met?
12. What metadata are relevant, and how will it be preserved, extracted and produced?
13. What are the data retention policies and practices?
14. What are the backup practices, and what tape archives exist?
15. Are there legacy systems to be addressed?
16. How will the parties handle voice mail, instant messaging and other challenging ESI?

Chapter 4: Discovery

17. Is there a preservation duty going forward, and how will it be met?
18. Is a preservation or protective order needed?
19. What e-mail applications are used currently and in the relevant past?
20. Are personal e-mail accounts and computer systems involved?
21. What principal applications are used in the business, now and in the past?
22. What electronic formats are common, and in what anticipated volumes?
23. Is there a document or messaging archival system?
24. What relevant databases exist?
25. Will paper documents be scanned, and if so, at what resolution and with what OCR and metadata?
26. What search techniques will be used to identify responsive or privileged ESI?
27. If keyword searching is contemplated, can the parties agree on keywords?
28. Can supplementary keyword searches be pursued?
29. How will the contents of databases be discovered? Queries? Export? Copies? Access?
30. How will de-duplication be handled, and will data be re-populated for production?
31. What forms of production are offered or sought?
32. Will single- or multipage .tiffs, PDFs or other image formats be produced?
33. Will load files accompany document images, and how will they be populated?
34. How will the parties approach file naming, unique identification and Bates numbering?
35. Will there be a need for native file production? Quasi-native production?
36. On what media will ESI be delivered? Optical disks? External drives? FTP?
37. How will we handle inadvertent production of privileged ESI?
38. How will we protect trade secrets and other confidential information in the ESI?
39. Do regulatory prohibitions on disclosure, foreign privacy laws or export restrictions apply?
40. How do we resolve questions about printouts before their use in deposition or at trial?
41. How will we handle authentication of native ESI used in deposition or trial?
42. What ESI will be claimed as not reasonably accessible, and on what bases?
43. Who will serve as liaisons or coordinators for each side on ESI issues?
44. Will technical assistants be permitted to communicate directly?
45. Is there a need for an e-discovery special master?
46. Can any costs be shared or shifted by agreement?
47. Can cost savings be realized using shared vendors, repositories or neutral experts?
48. How much time is required to identify, collect, process, review, redact and produce ESI?
49. How can production be structured to accommodate depositions and deadlines?
50. When is the next Rule 26(f) conference (because we need to do this more than once)?

APPENDIX B

**UNITED STATES DISTRICT COURT
WESTERN DISTRICT OF NEW YORK**

Plaintiff,

v.

Civil Action No. _____

Defendant.

[MODEL] ORDER REGARDING E-DISCOVERY IN PATENT CASES

The Court ORDERS as follows:

1. This Order supplements all other discovery rules and orders. It streamlines Electronically Stored Information (“ESI”) production to promote a “just, speedy, and inexpensive determination” of this action, as required by Federal Rule of Civil Procedure 1.
2. This Order may be modified in the Court’s discretion or by agreement of the parties. The parties shall jointly submit any proposed modifications within 30 days after the Federal Rule of Civil Procedure 16 conference. If the parties cannot resolve their disagreements regarding these modifications, the parties shall submit their competing proposals and a summary of their dispute.
3. Costs will be shifted for disproportionate ESI production requests pursuant to Federal Rule of Civil Procedure 26. Likewise, a party’s nonresponsive or dilatory discovery tactics will be cost-shifting considerations.
4. A party’s meaningful compliance with this Order and efforts to promote efficiency and reduce costs will be considered in cost-shifting determinations.
5. Absent a showing of good cause, general ESI production requests under Federal Rules of Civil Procedure 34 and 45, or compliance with disclosure requirements of the Local Patent Rules, shall not include metadata. However, fields showing the date and time that the document was sent and received, as well as the complete distribution list, shall generally be included in the production if such fields exist.
6. General ESI production requests under Federal Rules of Civil Procedure 34 and 45, or compliance with disclosure requirements of the Local Patent Rules, shall not include email or other forms of electronic correspondence (collectively “email”). To obtain email parties must propound specific email production requests.
7. Email production requests shall only be propounded for specific issues, rather than general discovery of a product or business.
8. Email production requests shall be phased to occur after the parties have exchanged initial disclosures, infringement contentions and accompanying documents pursuant to the Local Patent Rules, and invalidity contentions and accompanying documents pursuant to the Local Patent Rules.

9. Email production requests shall identify the custodian, search terms, and time frame. The parties shall cooperate to identify the proper custodians, proper search terms and proper timeframe.

10. Each requesting party shall limit its email production requests to a total of five custodians per producing party for all such requests. The parties may jointly agree to modify this limit without the Court's leave. The Court shall consider contested requests for up to five additional custodians per producing party, upon showing a distinct need based on the size, complexity, and issues of this specific case. Should a party serve email production requests for additional custodians beyond the limits agreed to by the parties or granted by the Court pursuant to this paragraph, the requesting party shall bear all reasonable costs caused by such additional discovery.

11. Each requesting party shall limit its email production requests to a total of five search terms per custodian per party. The parties may jointly agree to modify this limit without the Court's leave. The Court shall consider contested requests for up to five additional search terms per custodian, upon showing a distinct need based on the size, complexity, and issues of this specific case. The search terms shall be narrowly tailored to particular issues. Indiscriminate terms, such as the producing company's name or its product name, are inappropriate unless combined with narrowing search criteria that sufficiently reduce the risk of overproduction. A conjunctive combination of multiple words or phrases (*e.g.*, "computer" and "system") narrows the search and shall count as a single search term. A disjunctive combination of multiple words or phrases (*e.g.*, "computer" or "system") broadens the search, and thus each word or phrase shall count as a separate search term unless they are variants of the same word. Use of narrowing search criteria (*e.g.*, "and," "but not," "w/x") is encouraged to limit the production and shall be considered when determining whether to shift costs for disproportionate discovery. Should a party serve email production requests with search terms beyond the limits agreed to by the parties or granted by the Court pursuant to this paragraph, the requesting party shall bear all reasonable costs caused by such additional discovery.

12. The receiving party shall not use ESI that the producing party asserts is attorney-client privileged or work product protected to challenge the privilege or protection.

13. Pursuant to Federal Rule of Evidence 502(d), the inadvertent production of a privileged or work product protected ESI is not a waiver in the pending case or in any other federal or state proceeding.

14. The mere production of ESI in a litigation as part of a mass production shall not itself constitute a waiver for any purpose.

15. Except as expressly stated herein, nothing in this Order affects the parties' discovery obligation under the Federal or Local Rules.

DISTRICT COURT
EASTERN DISTRICT OF TEXAS

_____ DIVISION

Plaintiff,	§	
	§	
v.	§	Case No.
	§	
Defendant.	§	

[MODEL] ORDER REGARDING E-DISCOVERY IN PATENT CASES

The Court ORDERS as follows:

1. This order supplements all other discovery rules and orders. It streamlines Electronically Stored Information (“ESI”) production to promote a “just, speedy, and inexpensive determination” of this action, as required by Federal Rule of Civil Procedure 1.

2. This order may be modified in the court’s discretion or by agreement of the parties. The parties shall jointly submit any proposed modifications within 30 days after the Federal Rule of Civil Procedure 16 conference. If the parties cannot resolve their disagreements regarding these modifications, the parties shall submit their competing proposals and a summary of their dispute.

3. A party’s meaningful compliance with this order and efforts to promote efficiency and reduce costs will be considered in cost-shifting determinations.

4. Absent a showing of good cause, general ESI production requests under Federal Rules of Civil Procedure 34 and 45, or compliance with a mandatory disclosure requirement of this Court, shall not include metadata. However, fields showing the date and time that the document was sent and received, as well as the complete distribution list, shall generally be included in the production if such fields exist.

5. Absent agreement of the parties or further order of this court, the following parameters shall apply to ESI production:

A. General Document Image Format. Each electronic document shall be produced in single-page Tagged Image File Format (“TIFF”) format. TIFF files shall be single page and shall be named with a unique production number followed by the appropriate file extension. Load files shall be provided to indicate the location and unitization of the TIFF files. If a document is more than one page, the unitization of the document and any attachments and/or affixed notes shall be maintained as they existed in the original document.

B. Text-Searchable Documents. No party has an obligation to make its production text- searchable; however, if a party’s documents already ex-

ist in text-searchable format independent of this litigation, or are converted to text-searchable format for use in this litigation, including for use by the producing party's counsel, then such documents shall be produced in the same text-searchable format at no cost to the receiving party.

C. **Footer.** Each document image shall contain a footer with a sequentially ascending production number.

D. **Native Files.** A party that receives a document produced in a format specified above may make a reasonable request to receive the document in its native format, and upon receipt of such a request, the producing party shall produce the document in its native format.

E. **No Backup Restoration Required.** Absent a showing of good cause, no party need restore any form of media upon which backup data is maintained in a party's normal discovery obligations in the present case.

F. **Voicemail and Mobile Devices.** Absent a showing of good cause, voicemails, PDAs and mobile phones are deemed not reasonably accessible and need not be collected and preserved.

6. General ESI production requests under Federal Rules of Civil Procedure 34 and 45, or compliance with a mandatory disclosure order of this court, shall not include e-mail or other forms of electronic correspondence (collectively "e-mail"). To obtain e-mail parties must propound specific e-mail production requests.

7. E-mail production requests shall be phased to occur timely after the parties have exchanged initial disclosures, a specific listing of likely e-mail custodians, a specific identification of the fifteen most significant listed e-mail custodians in view of the pleaded claims and defenses,* infringement contentions and accompanying documents pursuant to P.R. 3-1 and 3-2, invalidity contentions and accompanying documents pursuant to P.R. 3-3 and 3-4, and preliminary information relevant to damages. The exchange of this information shall occur at the time required under the Federal Rules of Civil Procedure, Local Rules, or by order of the court. Each requesting party may also propound up to five written discovery requests and take one deposition per producing party to identify the proper custodians, proper search terms, and proper time frame for e-mail production requests. The court may allow additional discovery upon a showing of good cause.

8. E-mail production requests shall identify the custodian, search terms, and time frame. The parties shall cooperate to identify the proper custodians, proper search terms, and proper time frame. Each requesting party shall limit its e-mail production requests to a total of eight custodians per producing party for all such requests. The parties may jointly agree to modify this limit without the court's leave. The court shall consider contested requests for additional or fewer custodians per producing party, upon showing a distinct need based on the size, complexity, and issues of this specific case.

* A "specific identification" requires a short description of why the custodian is believed to be significant.

9. Each requesting party shall limit its e-mail production requests to a total of ten search terms per custodian per party. The parties may jointly agree to modify this limit without the court's leave. The court shall consider contested requests for additional or fewer search terms per custodian, upon showing a distinct need based on the size, complexity, and issues of this specific case. The search terms shall be narrowly tailored to particular issues. Indiscriminate terms, such as the producing company's name or its product name, are inappropriate unless combined with narrowing search criteria that sufficiently reduce the risk of overproduction. A conjunctive combination of multiple words or phrases (e.g., "computer" and "system") narrows the search and shall count as a single search term. A disjunctive combination of multiple words or phrases (e.g., "computer" or "system") broadens the search, and thus each word or phrase shall count as a separate search term unless they are variants of the same word. Use of narrowing search criteria (e.g., "and," "but not," "w/x") is encouraged to limit the production and shall be considered when determining whether to shift costs for disproportionate discovery.

10. Pursuant to Federal Rule of Evidence 502(d), the inadvertent production of a privileged or work product protected ESI is not a waiver in the pending case or in any other federal or state proceeding.

11. The mere production of ESI in a litigation as part of a mass production shall not itself constitute a waiver for any purpose.

12. Except as expressly stated, nothing in this order affects the parties' discovery obligations under the Federal or Local Rules.

- current as of March 19, 2014 (General Order 14-6)

Chapter 5

Claim Construction

- 5.1 Timing and Procedure 5
 - 5.1.1 Timing of *Markman* Hearings 5
 - 5.1.2 Pre-*Markman* Procedures 6
 - 5.1.2.1 Mandatory Disclosure of Positions 6
 - 5.1.2.1.1 Early Disclosure of Infringement and Invalidity Contentions 7
 - 5.1.2.1.2 Disclosure of Claims to Construe and Proposed Constructions 7
 - 5.1.2.1.3 Mechanisms for Limiting the Number of Claim Terms to Construe 8
 - 5.1.2.1.3.1 Severance Versus Postponement 10
 - 5.1.2.1.4 Recommended Approach: Mandatory Disclosure of Impact of Proposed Constructions 12
 - 5.1.2.1.5 Recommended Approach: Mandatory Disclosure of Terms Requiring Fact-Finding 14
 - 5.1.2.2 Educating the Court About Underlying Science and Technology 15
 - 5.1.2.2.1 Technology Tutorials 16
 - 5.1.2.2.1.1 Anticipating the Need for an Appellate Record 18
 - 5.1.2.2.2 Court-Appointed Experts 18
 - 5.1.2.2.2.1 Technical Advisor 18
 - 5.1.2.2.2.2 Special Master 20
 - 5.1.2.2.2.3 Expert Witness 20
 - 5.1.3 Conduct of the *Markman* Hearing 21
 - 5.1.3.1 The “Evidentiary” Nature of *Markman* Hearings 21
 - 5.1.3.2 Application of the Federal Rules of Evidence 22
 - 5.1.3.3 Safeguards on Extrinsic Evidence 22
 - 5.1.3.4 Evidence of the Accused Device 23
 - 5.1.3.5 Evidence of the Prior Art 23
 - 5.1.3.6 The Need to Focus *Markman* Proceedings on Claim Interpretation 24
 - 5.1.3.7 Sequence of Argument 25
 - 5.1.3.8 Claim Construction in Multidefendant Disputes 25
 - 5.1.4 The *Markman* Ruling 28
 - 5.1.4.1 Interrelationship to Jury Instructions 28
 - 5.1.4.2 Basis for Appellate Review 29
 - 5.1.4.3 Not All Terms Require “Construction” 29
 - 5.1.4.4 The Court May Adopt Its Own Construction 30
 - 5.1.4.5 Tentative Rulings Prior to the *Markman* Hearing 30
 - 5.1.5 Amendments to Infringement and Invalidity Contentions 31
 - 5.1.6 Interlocutory Appeal of *Markman* Rulings 31
 - 5.1.7 Application of the *Markman* Ruling to Trial 32
- 5.2 Analytic Framework and Substantive Principles 33
 - 5.2.1 Claim Drafting: The Genesis and Evolution of Claim Terms 34
 - 5.2.2 Sources for Deriving Claim Meaning 36
 - 5.2.2.1 Principal Source: Intrinsic Evidence 37
 - 5.2.2.1.1 Prosecution History 37
 - 5.2.2.1.2 Related and Foreign Applications 38
 - 5.2.2.2 Extrinsic Evidence Is Permissible, but It May Not Contradict or Override Intrinsic Evidence 39
 - 5.2.2.2.1 Illustrations of Reliance (and Nonreliance) upon Extrinsic Evidence 40
 - 5.2.2.2.2 Conclusory Expert Opinions Should Be Disregarded 43
 - 5.2.3 Claim Construction: Two Stages of Analysis 43
 - 5.2.3.1 Step 1: Is Construction of a Claim Required? 43
 - 5.2.3.1.1 Is There a Genuine Dispute About the Claim Term? 44
 - 5.2.3.1.2 Would Claim Construction Help the Jury? 45
 - 5.2.3.1.3 Is Claim Construction a Priority? 45

- 5.2.3.1.4 Have the Claims Been Construed Before? 45
- 5.2.3.1.5 Is the Term Amenable to Construction? 46
 - 5.2.3.1.5.1 Lay Terms 47
 - 5.2.3.1.5.2 Terms of Degree 48
 - 5.2.3.1.5.2.1 Terms of Degree: Potential Indefiniteness 48
 - 5.2.3.1.5.2.2 The Court Should Not Delineate Terms of Degree “Where the Patent Provides No Standard” 50
 - 5.2.3.1.5.2.3 The Appropriate Standard for Defining or Declining to Define Terms of Degree 51
 - 5.2.3.1.5.3 Technical Terms 52
- 5.2.3.2 Step 2: Interpretation of Claim Terms 52
 - 5.2.3.2.1 Claim-Construction Framework 53
 - 5.2.3.2.2 Starting Point for Analysis: “Ordinary Meaning” 56
 - 5.2.3.2.2.1 “Presumption of Dictionary Definition” Obsolete 57
 - 5.2.3.2.2.2 “Heavy Presumption” of Ordinary Meaning 57
 - 5.2.3.2.3 Interpreting Claim Language in Light of the Specification 58
 - 5.2.3.2.3.1 The Role of Preferred Embodiments in Claim Construction 59
 - 5.2.3.2.3.1.1 Claim Scope Generally Includes Preferred Embodiments 60
 - 5.2.3.2.3.1.2 Is the Patent Limited to the Preferred Embodiments? 60
 - 5.2.3.2.3.1.3 Does the Number and/or Range of Embodiments Affect the Scope of the Claims? 62
 - 5.2.3.2.3.1.4 Does Ambiguity in a Claim Term Limit Its Scope to Preferred Embodiment(s)? 63
 - 5.2.3.2.3.1.5 Characterizations of “the Invention” or “the Present Invention” 64
 - 5.2.3.2.3.2 Distinctions over the Prior Art 66
 - 5.2.3.2.3.3 Consistent Usage of Claim Terms 67
 - 5.2.3.2.3.4 Prosecution Disclaimers 68
 - 5.2.3.2.4 Looking to Other Claims: The Doctrine of Claim Differentiation 69
 - 5.2.3.2.4.1 Presumption of Claim Differentiation May Be Rebutted Based on Specification or Prosecution History Estoppel 70
 - 5.2.3.2.4.2 Presumption of Claim Differentiation Does Not Apply to Means-Plus-Function Claims 71
 - 5.2.3.2.5 Significance of the “Preamble” in Claim Construction 71
- 5.2.3.3 Claim Terms Having Conventional, Presumed, or Established Meanings 72
- 5.2.3.4 Interpreting Terms to Preserve Validity 78
- 5.2.3.5 Special Case: Means-Plus-Function Claims Limited to Structures in Specification and Equivalents Thereof as of Time of Issuance 78
 - 5.2.3.5.1 Step 1: Is the Term in Question “Means-Plus-Function”? 79
 - 5.2.3.5.2 Step 2: Interpretation of Means-Plus-Function Claim Terms 80
 - 5.2.3.5.2.1 Step 2A: Identify Claim-Term Function 80
 - 5.2.3.5.2.2 Step 2B: Identify “Corresponding Structure, Material, or Acts” 81
 - 5.2.3.5.2.3 Step 2C: “Equivalents Thereof” 81
 - 5.2.3.5.2.4 Specific Rule for Means-Plus-Function Claims in the Computer Software Context 81
- 5.2.4 Product-by-Process Claims 82
- 5.2.5 Dysfunctional Claims: Mistakes and Indefiniteness 83
 - 5.2.5.1 Mistakes 83
 - 5.2.5.2 Indefiniteness 84
- 5.3 Deference to Prior Claim-Construction Rulings 88
 - 5.3.1 Distinguishing Among Preclusion and Estoppel Doctrines 89
 - 5.3.2 Issue Preclusion/Collateral Estoppel 91
 - 5.3.2.1 Identity of Issues 91
 - 5.3.2.2 Actual Litigation 92
 - 5.3.2.3 Full and Fair Opportunity to Litigate 92
 - 5.3.2.4 Determination Was Essential to the Final Judgment 93

Chapter 5: Claim Construction

5.3.2.4.1	Finality	93
5.3.2.4.2	Essential to the Final Judgment	95
5.3.2.5	Reasoned Deference as a Prudent Approach to Issue Preclusion	96
5.3.3	Judicial Estoppel	97
5.3.4	Stare Decisis	98
5.3.5	U.S. International Trade Commission Determinations	101
5.3.6	Patent and Trademark Office Determinations	101
5.3.7	Motions to Vacate Claim-Construction Rulings in Connection with Settlement	101
5.4	Practical Tips for Claim Construction	102
5.4.1	Recognizing and Avoiding the Pitfalls of Sound-Bite and “Cite”-Bite Advocacy	102
5.4.1.1	“Heavy Presumption of Ordinary Meaning”	103
5.4.1.2	“Presumption in Favor of Dictionary Definition” No Longer Applies	103
5.4.1.3	Reliance on Extrinsic Evidence Is Permissible but Cannot Override Intrinsic Evidence	104
5.4.2	Checklist/Discussion Points for Claim-Construction Hearing	104
5.4.2.1	Procedural Aspects	104
5.4.2.2	Substantive Aspects	105
Appendix 5.1	Joint Claim-Construction Statement Order	107
Appendix 5.2	Sample Joint Claim-Construction Charts	109

The construction of patent claims plays a critical role in nearly every patent case. It is central to the evaluation of infringement and validity, and can affect or determine the outcome of other significant issues such as unenforceability, enablement, and remedies. The process by which courts interpret patent claims represents one of the most distinctive aspects of patent litigation. This chapter explores the procedural and substantive aspects of claim construction.

It will be useful to have some historical and jurisprudential context for claim construction before delving into the details. *See generally* J. Jonas Anderson & Peter S. Menell, *Informal Deference: A Historical, Empirical, and Normative Analysis of Patent Claim Construction*, 108 Nw. U. L. Rev. 1 (2014). As the use of juries in patent cases has grown since 1980, whether the judge or the jury should construe the terms of patent claims has emerged as a pressing issue. Until 1996, it was common for courts to charge juries with claim construction. Resolving the scope of patent claims in this manner, however, significantly increased the complexity and uncertainty of trials. The question of who should determine the meaning of patent claims came before the Supreme Court in the seminal case of *Markman v. Westview Instruments*, 517 U.S. 370 (1996), resulting in the term “*Markman* hearing.”

Markman sued Westview Instruments for infringement of its patent on a system for tracking articles of clothing in a dry-cleaning operation. After a jury found infringement, Westview Instruments moved for judgment as a matter of law on the ground that the patent and its prosecution history made it clear that the patent claims at issue did not extend to Westview’s accused device. The trial court granted the motion based on its examination of the relevant documentation. On appeal, the patentee asserted that the trial court’s judgment violated its Seventh Amendment right to a jury trial on claim construction. Markman stressed that it had introduced expert testimony on the issue. Based largely on functional considerations, the Supreme Court held that claim construction is a matter for the court and hence beyond the province of the jury. The Court emphasized that judges are better equipped than juries to construe the meaning of patent claim terms, given their training and experi-

ence interpreting written instruments (such as contracts and statutes). Even though cases may arise in which the credibility of competing experts affects the determination of claim meaning, “in the main” the Court anticipated that claim-construction determinations will be “subsumed within the necessarily sophisticated analysis of the whole document, required by the standard construction rule that a term can be defined only in a way that comports with the instrument as a whole.” *Id.* at 389. The Court also emphasized that judges are better able to promote uniformity and certainty in claim construction.

Notwithstanding clear indications in the Supreme Court’s *Markman* opinion that the Court did not consider claim construction to be a pure question of law, *see id.* at 378 (characterizing claim construction as a “mongrel [or mixed fact/law] practice”), a sharply divided Federal Circuit adhered to its view that claim construction is a pure question of law subject to de novo review and downplayed the Supreme Court’s more limited characterization of claim construction as simply an “issue for the judge, not the jury.” *See Cybor Corp. v. FAS Techs., Inc.*, 138 F.3d 1448 (Fed. Cir. 1998) (en banc). Over the next eighteen years, the Federal Circuit struggled with this issue, with several members continuing to question *Cybor*’s view that claim construction is a pure question of law. *See, e.g., Lighting Ballast Control LLC v. Philips Elecs. N. Am. Corp.*, 744 F.3d 1272, 1297 (Fed. Cir. 2014) (en banc) (O’Malley, J., dissenting); *Amgen Inc. v. Hoechst Marion Roussel, Inc.*, 469 F.3d 1039, 1040 (Fed. Cir. 2006) (Michel, C.J., joined by Rader, J., dissenting from denial of rehearing en banc). The Supreme Court resolved the controversy in 2015, holding that patent claim construction can entail fact-finding. It restored the fundamental juridical principle—reflected in Federal Rule of Civil Procedure 52(a)(6)—that the Federal Circuit, like other appellate courts, must “give due regard to the trial court’s opportunity to judge the witnesses’ credibility” and defer to the trial court’s factual determinations unless “clearly erroneous.” *See Teva Pharms. USA, Inc. v. Sandoz, Inc.*, 135 S. Ct. 831, 834 (2015).

Building on its *Markman* framework, the Supreme Court’s *Teva* decision endorses a hybrid standard of appellate review that is balanced, structurally sound, and legally appropriate. Under this hybrid standard, the factual determinations underlying claim-construction rulings are subject to the “clearly erroneous” (or “abuse of discretion”) standard of review, while the Federal Circuit exercises de novo review over the ultimate claim-construction decision. In this manner, district judges can use their distinctive vantage point and evidentiary tools to ferret out factual underpinnings while the Federal Circuit can operate as a check on fidelity to the patent instrument. Therefore, even though the Federal Circuit retains de novo review of whether a trial court’s construction of a patent claim comports with the intrinsic evidence—the patent document and prosecution history—the appellate court must nonetheless sustain the trial court’s subsidiary factual findings unless clearly erroneous. Thus, where the intrinsic evidence does not resolve the meaning of a disputed patent claim term, the district court’s resolution, if adequately grounded in extrinsic evidence, will control. *See J. Jonas Anderson & Peter S. Menell, Restoring the Fact/Law Distinction in Patent Claim Construction*, 109 Nw. U. L. Rev. Online 187 (2015).

This chapter begins with the procedural matters relating to claim construction and then presents the framework and substantive rules governing claim interpretation.

5.1 Timing and Procedure

In the years since *Markman*, courts have experimented with different approaches to the claim-construction process. This section presents and discusses the main lessons for:

- determining when to hold the *Markman* hearing
- streamlining the pre-*Markman* process
- the use of tutorials, experts, and advisors in claim construction
- identifying subsidiary factual questions on which extrinsic evidence and evidentiary hearings could be useful
- conducting a *Markman* hearing efficiently and effectively;
- rendering a *Markman* ruling
- integrating the *Markman* ruling into a trial

We identify issues that commonly arise in the claim-construction process (from the commencement of the case through trial), explain the pros and cons of different approaches to these issues, characterize best practices, and suggest tools to address specific situations.

5.1.1 Timing of *Markman* Hearings

Perhaps the most important case-management decision relating to the *Markman* process is its timing. Nearly twenty years of practice provide a guide to when to hold the *Markman* hearing. It has also shown the importance of flexibility to accommodate the demands of different types of cases.

Early *Markman* hearings (i.e., within about five months of the case-management conference) can be appropriate in some contexts. In cases that present a well-crystallized question of claim construction that can resolve liability without extensive discovery, an early *Markman* hearing can be advantageous. Providing parties with an early ruling on key claim-construction issues can promote settlement and avoid the cost and burden of lengthy discovery. However, in practice, several disadvantages often outweigh these advantages. Knowing what issues to present at a *Markman* hearing frequently requires significant discovery into the nature of the accused device and of the prior art. Thus, a court will often have to revisit an early *Markman* ruling when new issues emerge.

A majority of courts have found that the most opportune time to hold the *Markman* hearing is midway through, or before the close of, fact discovery, and prior to expert discovery. This timing affords the parties sufficient discovery in advance of the claim-construction hearing to gain an understanding of the liability issues and accurately identify the terms needing construction. It also leaves time for the parties to finish fact discovery and to focus expert discovery after the court has issued its

claim-construction ruling. This timing also avoids requiring an expert to base her opinion on alternative claim constructions or to do a new report if the court does not adopt either party's construction and devises its own. *See, e.g., Magarl, L.L.C. v. Crane Co.*, 2004 U.S. Dist. LEXIS 24283, at *44, 2004 WL 2750252 (S.D. Ind. 2004) (encouraging holding *Markman* hearings in advance of summary judgment briefing, because a "claim construction which precedes summary judgment could avoid unnecessary alternative briefing and evidentiary submissions, including expert witness testimony addressed to or based on rejected claim constructions").

If, however, a particular claim construction will be case or claim dispositive, the court should hold a joint claim-construction/summary judgment hearing on case-dispositive terms. Although this may require that the experts address several possible claim constructions, the benefits of efficiency and cost savings outweigh the additional burden. *See* §§ 6.1.2–6.1.3.4.

Some courts have deferred *Markman* hearings until the completion of expert discovery. They resolved claim-construction disputes in conjunction with summary motions made shortly before trial, or at trial, when jury instructions are settled. Although there may be some advantages to holding a *Markman* hearing at or near the end of a case, this approach has many drawbacks in practice. Holding a late *Markman* hearing may upset the experts' positions, inject new issues into the case, especially where the court devises its own construction that does not square with that of either party, or it may deprive litigants of enough time to settle the case before trial.

5.1.2 Pre-*Markman* Procedures

To promote efficient and effective *Markman* hearings, a court will want to address the procedures and ground rules at a relatively early stage in case management. As discussed in Chapter 2, patent local rules place particular emphasis on timely and orderly identification of disputed claim terms. We begin this section with further discussion of best practices to bring those disputes and the parties' arguments to the surface prior to the *Markman* hearing. Depending on the complexity of the technology at issue, it is often useful to plan for technology tutorials in conjunction with the *Markman* proceeding. We discuss several practical issues relating to the timing, form, and conduct of such tutorials and the use of court-appointed experts to assist in claim construction.

5.1.2.1 Mandatory Disclosure of Positions

The primary goals of the procedures before a *Markman* hearing are to: (1) ensure that the parties' claim-construction positions are squarely joined, which reduces false and hidden disputes; and (2) resolve any disputes about how the *Markman* hearing should be conducted so the hearing is efficient, helpful to the court, and without procedural disarray.

The following steps have proven especially effective in accomplishing these objectives.

5.1.2.1.1 Early Disclosure of Infringement and Invalidity Contentions

Requiring disclosure of infringement contentions at the start of the case is a proven way to focus at least some of the disputes at issue for the *Markman* hearing. Early disclosure of infringement contentions is a feature of the patent local rules discussed in Chapter 2. See Appendix D (listing jurisdictions with patent local rules). In jurisdictions that have not adopted patent local rules, courts are free to build these disclosure requirements into their scheduling orders. These infringement contentions require the patentee to specify, among other things, each claim of each patent in suit that is allegedly infringed; each instrumentality that allegedly infringes each asserted claim; and a claim chart detailing where each element of an asserted claim is found in each accused instrumentality. See, e.g., N.D. Cal. Patent L.R. 3-1; E.D. Tex. Patent L.R. 3-1.

With its infringement contentions, the party must produce, among other things, all documents evidencing the conception and reduction to practice of each asserted claim, along with documents sufficient to show the disclosure of the claimed inventions to others prior to filing of the patent application. Similarly, the court can help focus *Markman* issues by requiring that the alleged infringer disclose invalidity contentions after receipt of the infringement contentions. This requires the alleged infringer to specify, among other things, the identity of each item of prior art that allegedly anticipates each asserted claim or renders it obvious, and any grounds for invalidity due to indefiniteness, enablement, or written description. See § 112. With its invalidity contentions, the accused infringer must produce all prior art not already of record, as well as documents sufficient to show the operation of the accused devices.

These disclosures force parties to crystallize their theories early in the case and thereby identify matters that the *Markman* hearing must resolve. They also help streamline discovery by mandating the disclosures that are core to patent cases, thus reducing the need for interrogatories, document requests, and contention depositions. Early infringement contentions can, however, lead to unnecessary discovery disputes because they can occur before parties fully understand their positions.

5.1.2.1.2 Disclosure of Claims to Construe and Proposed Constructions

A widespread problem in patent cases is that the parties' *Markman* briefing might not effectively join the issues that the *Markman* hearing must resolve, or might not confront claim-construction issues that the parties will ultimately litigate at trial. To avoid this problem, the court should set a meet-and-confer schedule in its scheduling order to require parties to identify terms that need construction. These procedures help ensure that the issues for the *Markman* hearing are specified in advance of the briefing cycle, as opposed to briefing revealing issues for the first time. Ordering a meet-and-confer process also helps ensure that the parties' briefing does not wastefully address false or merely hypothetical disputes. Ordering parties to disclose their claim-construction positions also discourages "hidden" disputes that may

otherwise arise at trial. This structured meet-and-confer process is part of the patent local rules of the Northern District of California, the Eastern District of Texas, and a growing number of district courts. It is required within ten days of service of the invalidity contentions. *See, e.g.*, N.D. Cal. Patent L.R. 4-1 to 4-3; E.D. Tex. P.R. 4-1 to 4-3.

As part of this process, the court’s scheduling order should set a date for the parties to exchange proposed constructions of the identified terms. Setting this date approximately twenty days after exchanging lists of terms is appropriate. As part of this disclosure, some jurisdictions also require that the parties disclose their supporting evidence, including whether they will rely on expert witnesses. This disclosure of extrinsic evidence is particularly important to provide a baseline understanding of what aspects of the claim-construction process will involve district court fact-finding in accordance with *Teva Pharmaceuticals USA, Inc. v. Sandoz*, 135 S. Ct. 831 (2014).

5.1.2.1.3 Mechanisms for Limiting the Number of Claim Terms to Construe

Cases commonly involve multiple patents, dozens or even hundreds of claims, and multitudes of claim terms that may need construction. If left unmanaged, the sheer complexity of this tangle of terms can overwhelm the merits of a lawsuit. Courts should exercise their inherent case-management authority to limit the number of claims and claim terms at issue, as appropriate. *See* §§ 2.1.3.1 (patent and claim winnowing); 2.1.3.2.1 (claim-term winnowing).

At the *Markman* phase, courts have wide discretion to limit the number of claim terms at issue. Restricting the scope of the *Markman* hearing focuses the parties’ and the court’s attention on the key issues, which may dispose of the case. It also facilitates more prompt and well-reasoned ruling on the central matters in the case. Courts have experimented widely with various approaches to managing the scope of *Markman* hearings. A substantial body of experience has shown that allowing the parties wide discretion to brief all claim terms that are potentially at issue invites false or inconsequential disputes, particularly because parties reflexively seek to avoid the risk of a waiver finding if they refrain from raising peripheral disputes.

To focus patent litigation on the most salient issues, a growing number of courts have established a presumptive limit on the number of claim terms—typically ten—that will be presented at the *Markman* hearing. The Northern District of California revised its patent local rules to require the parties to jointly identify ten terms “likely to be most significant to resolving the parties’ dispute, including those terms for which construction may be case or claim dispositive.” *See* N.D. Cal. Patent L.R. 1-2; *see also* N.D. Ill. LPR 4.1(b) (requiring parties to limit terms submitted for construction to ten, absent a showing of good cause). The default ten-term limit can be adjusted upward or downward depending on the circumstances of the case.

There are several factors that may influence whether to increase the number of terms to be construed, such as the number of patents in dispute and the extent to which means-plus-function (§ 112(f)) claim terms are present. Ten can be high for single-patent cases, but low for multipatent cases. *See* N.D. Ill. LPR 4.1(b) (noting that the “assertion of multiple nonrelated patents shall, in an appropriate case, con-

stitute good cause”). Means-plus-function claims generally must be construed to identify the corresponding structure in the specification. Hence, where multiple such claims are present, courts may need to adjust the term ceiling upward.

The parties are generally required to meet and confer to identify the ten most significant terms in dispute. In addition to any terms that the parties mutually agree are the most significant, the parties are allocated half of the remaining ten terms. With this allocation, they can identify additional terms for the *Markman* hearing to construe. See N.D. Ill. LPR 4.1(b) (stating that “[i]f the parties are unable to agree upon ten terms, then five shall be allocated to all plaintiffs and five to all defendants”).

The ten-term limit does not fix the total number of terms that can be construed before trial. Parties can seek to construe additional terms at later phases in the case. See, e.g., *Apple, Inc. v. Samsung Elecs. Co.*, 932 F. Supp. 2d 1076, 1079 (N.D. Cal. 2013) (finding no waiver of right to construe term that was not included in the initial ten-term proceedings, where party disclosed its intent to contest additional terms). However, for purposes of the principal *Markman* hearing, this channeling of the most significant terms allows courts to resolve the key disputes efficiently.

The ten-term default rule has generally worked well. It has focused the parties on the terms that are most likely to be outcome determinative. See N.D. Ill. LPR 4.1 (requiring the parties to certify whether a term identified for construction is potentially outcome-determinative); *id.* (Comment) (noting that the ten-term limit is intended to require the parties to focus upon outcome-determinative or otherwise significant disputes”). Courts have adopted variants to suit the needs of particular cases. See, e.g., *In re MyKey Tech. Inc. Patent Litig.*, 2014 U.S. Dist. LEXIS 83147, 2014 WL 2740733 (C.D. Cal. 2014) (in an MDL proceeding combining six lawsuits, the court construed up to ten terms per patent among the three patents).

Courts should be sensitive to the gamesmanship that can arise in selecting the ten terms. Often, one party will be less interested in having terms construed than the other party. It may list terms of little consequence to the case, thereby effectively “burning” half of the terms that the court will hear. Typically, the defendant is the party with a greater interest in having claims construed, and it may be prejudicial to the defendant to limit its ability to only have ten claim terms construed (particularly where the plaintiff has asserted a large number of claims). For this reason, equal division of the ten-term limit can be overly rigid, especially where the parties disagree on which are the most salient disputed claim terms. By insisting that parties explain why they seek construction of the terms they propose, as discussed in § 5.1.2.1.4, courts can reduce the potential for this type of abuse. Furthermore, a claim phrase can reappear in different claims with slightly different wording, giving rise to the argument that each particular instance of the term must be counted against the ten-term limit. Because the same underlying factors will typically drive the proper construction of similarly worded terms (although they might not be exactly the same), courts should accommodate reasonable requests to group similarly worded terms together in counting toward the ten-term limit.

Other mechanisms to manage the scope of *Markman* proceedings include page limits on briefing and time restrictions at the *Markman* hearing. Parties will natural-

ly allocate limited presentation times (written or oral) to the key disputes, and limits on briefing or oral argument will help streamline the *Markman* proceedings. However, when parties feel that they could face a waiver situation if all disputed terms are not addressed at the *Markman* proceedings, they will tend to cram additional arguments into the written or oral presentations. Ultimately, this is a less helpful mechanism than limiting the number of terms that the court will address in the main *Markman* proceeding.

Courts risk upsetting trial dates and can invite reversal if they overly constrain or defer the *Markman* process. Ultimately, the court must rule on all material claim-construction disputes in cases that go to trial. See *O2 Micro Int'l Ltd. v. Beyond Innovation Tech. Co.*, 521 F.3d 1351, 1360–61 (Fed. Cir. 2008). It is legal error, however, for the court to allow the parties to argue competing claim-construction positions to the jury and, as discussed in § 5.1.4.3, the court may properly resolve the claim-construction dispute with reference to a “plain meaning” construction. See *CytoLogix Corp. v. Ventana Med. Sys., Inc.*, 424 F.3d 1168, 1172 (Fed. Cir. 2005) (“[B]y agreement the parties also presented expert witnesses who testified before the jury regarding claim construction, and counsel argued conflicting claim constructions to the jury. This was improper, and the district court should have refused to allow such testimony despite the agreement of the parties.”); *Every Penny Counts, Inc. v. Am. Express Co.*, 563 F.3d 1378, 1383 (Fed. Cir. 2009) (“[T]he court’s obligation is to ensure that questions of the scope of the patent claims are not left to the jury. To fulfill this obligation, the court must see to it that disputes concerning the scope of the patent claims are fully resolved.”) (internal citation omitted); *Medien Patent Verwaltung AG v. Warner Bros. Entm’t*, 2014 U.S. Dist. LEXIS 12360, *31, 2014 WL 333470, *11 (S.D.N.Y. Jan. 29, 2014) (“Only the Court can resolve what is obviously a dispute about the meaning of the claim language, and the fact that the dispute is raised late in the day does not relieve me of that burden.”); *Wi-Lan, Inc. v. Apple Inc.*, 811 F.3d 455, 464–66 (Fed. Cir. 2016) (reversing JMOL that was premised on new claim-construction issue not previously raised before the jury). The more that outstanding claim-construction issues are deferred until the late phases of litigation or are not resolved until trial, the greater the likelihood of legal error and surprises at trial. Resolving the material claim-construction disputes well in advance of trial will prevent procedural aberrations from distracting from or distorting the merits of a case and minimize the risk of reversal and the need for retrial.

5.1.2.1.3.1 Severance Versus Postponement

Courts faced with a case involving many patents and patent claims, frequently with diverse technologies, have struggled to find ways to reduce the case to a manageable size that the court and a jury can handle in one trial.

District courts typically have addressed this issue in the context of multipatent disputes in two ways: (1) allowing the parties to select a limited subset of patents to be tried in the first instance and severing the remaining patents for a subsequent trial if needed, or requiring the plaintiff to winnow the number of patents and/or claims asserted, in the interests of avoiding duplicative litigation; and (2) limiting the total

number of disputed claim terms to be construed, and hoping that those terms will resolve the dispute.

With regard to the first approach, the Federal Circuit has ruled that the district court's case-management prerogatives can trump a patentee's alleged right to try all of the patent claims it asserts, even when the additional claims would have been tried in a severed action. In a particularly large, multidistrict litigation involving twenty-five separate actions, with 1,975 asserted claims from thirty-one patents, against fifty groups of related defendants, the district court substantially pared the number of claims that the patentee could try. *See In re Katz Interactive Call Processing Patent Litig.*, 639 F.3d 1303 (Fed. Cir. 2011). The court ordered the patentee to limit its claims to sixty-four (including no more than forty claims per defendant group, to be narrowed to sixteen claims per group after discovery). Further, it included a proviso that the patentee could add new claims if they "raise[d] issues of infringement/validity that [were] not duplicative" of previously selected claims. *Id.* at 1309. The patentee then moved to sever and stay the litigation as to the unselected claims, reasoning that, absent a severance, the litigation would have a preclusive effect on the unselected claims. The district court refused to sever, and the Federal Circuit affirmed, finding no violation of the patentee's right to due process. Particularly important in the court's ruling was that the patentee had failed to state why the unselected claims were not duplicative of those already set for trial. The Federal Circuit's approval of the district court's approach cautioned that if the court had not allowed the patentee to show why the unselected claims presented unique issues, the refusal to sever those claims would have been reversed. *Id.* at 1312–13. Understandably for patentees, showing why the subset of claims to be tried is insufficient could reveal potential weaknesses, possibly explaining why it was not done in *Katz*.

Subsequent courts have reaffirmed *Katz*'s principle that a district court can impose limits on the number of claims that a patentee may try, so long as the court provides for a "safety valve" that permits later trial on claims that present unique issues on liability or damages. *See, e.g., Masimo Corp. v. Philips Elecs. N. Am. Corp.*, 918 F. Supp. 2d 277, 284 (D. Del. 2013) (limiting the patentee to thirty claims for trial, and limiting claim construction to twenty terms, but allowing expansion upon a showing of good cause); *Joao Control and Monitoring Sys., LLC v. Ford Motor Co.*, Nos. 13-CV-13615, 13-CV-13957, 2014 U.S. Dist. LEXIS 2966, 2014 WL 106926 (E.D. Mich. Jan. 10, 2014) (limiting the plaintiff to three asserted claims per each of three patents and allowing modification for good cause).

Whereas patent and patent claim winnowing has been applied in a relatively small, but growing, subset of especially complex cases, the second approach—limiting the number of claim terms to be construed—has become routine in many districts. Winnowing the number of claim terms construed risks that the chosen terms will not resolve the dispute, which leaves the court with two unattractive options: either doing claim construction hurriedly at the end of the pretrial schedule, which disrupts expert reports, summary judgment, and other pretrial scheduling, or postponing the trial for another round of claim construction. The Federal Circuit has made clear that the district court may not proceed to trial without resolving all remaining claim-construction disputes. *See O2 Micro Int'l*, 521 F.3d at 1360–63. To

preclude improper invitation of jurors to define terms, the Federal Circuit has permitted courts to modify and further construe terms at trial. *See, e.g., Pressure Prods. Med. Supplies, Inc. v. Greatbatch Ltd.*, 599 F.3d 1308, 1316 (Fed. Cir. 2010) (“As this court has recognized, ‘district courts may engage in a rolling claim construction, which the court revisits and alters its interpretation of the claim terms as its understanding of the technology evolves.’”). In general, courts have gravitated toward the severance and stay option and have found that the subsequent trials are not needed. Some courts limit the number of asserted patent claims prior to claim construction, with a further limitation imposed after claim construction, and yet a further limitation before trial. This step-wise approach allows the plaintiff to refine its theories as the case progress through discovery, claim construction, and dispositive motions.

5.1.2.1.4 Recommended Approach: Mandatory Disclosure of Impact of Proposed Constructions

Requiring parties to state the intended ramifications of their proposed constructions on the merits of the case is an especially useful case-management tool. Many infringement and invalidity disputes hinge on legal questions of claim interpretation and can be resolved on summary judgment. The Northern District of California requires parties to specify in their joint claim-construction statement any term whose construction will be case or claim dispositive to provide context to the claim-construction disputes. *See* N.D. Cal. Patent L.R. 4-3(c).

As outlined in § 6.1.2, courts should integrate the summary judgment process with claim construction by providing a framework for parties to specify how claim-construction rulings would affect summary judgment. Chapter 6 outlines a dual-track summary judgment process, whereby claim-construction-driven motions are resolved in connection with the *Markman* process, and remaining motions are resolved at a separate stage in the case.

This integrated approach requires the parties to state the reasons for seeking construction of any terms that are litigated in the *Markman* process, regardless of whether they are asserted for summary judgment purposes. It affords courts the context for making important rulings in the *Markman* process and also provides a useful tool for reducing disputes. In practice, parties often cannot articulate why their definition differs materially from their opponent’s, but they may nonetheless adhere to it. Left unresolved, these less-than-meaningful discrepancies in wording can result in wasteful briefing and unnecessary consumption of the court’s time. Requiring disclosure of *why* these terms need to be construed often reveals false disputes. Where there is not a meaningful dispute underlying a party’s request for a construction, courts are well within their authority to decline construing that term. *See Vivid Techs., Inc. v. Am. Sci. & Eng’g, Inc.*, 200 F.3d 795, 803 (Fed. Cir. 1999) (“AS&E is correct that although the claims are construed objectively and without reference to the accused device, only those terms need be construed that are in controversy, and only to the extent necessary to resolve the controversy.”).

Terms that are to be construed for summary judgment purposes should be specifically identified, along with a statement of which party (or both) would seek summary judgment on the basis of that term and why. As an example of the recom-

mended form of disclosure, Table 5.1 illustrates a sample claim chart showing a term to be construed (“steering wheel”), along with the defendant’s reasons for seeking summary judgment.

**Table 5.1
Claim Construction Chart**

Claim Term	Plaintiff’s Construction	Ramifications	Defendant’s Construction	Ramifications
“steering wheel”	any device for directing a vehicle		a circular device for directing a vehicle	<p><u>Noninfringement:</u> Accused device lacks a circular steering device, so summary judgment of no infringement is proper.</p> <p><u>Invalidity:</u> ABC reference anticipates the claims as a matter of law so the patent [or specific claim] is invalid and summary judgment should be granted.</p>

Appendix 5.1 contains a model order for requiring parties to file their joint claim-construction statement in this format. Appendix 5.2 contains examples of such claim charts.

Many claim terms will not be the focus of summary judgment motions, but are the focus of claims or defenses that will be presented at trial. There can also be collateral reasons for parties to seek construction of terms, such as ensuring that a defendant’s future products will be safely outside the scope of an asserted patent. The court should also require the parties to disclose why they are seeking constructions of these other terms.

The court should hold a telephone conference with the parties after they file the list of terms to be construed and the reasons for their submission, prior to the briefing cycle. During this call, the court can state which summary judgment motions it is willing to entertain in connection with the *Markman* proceedings. Moreover, forcing the parties to explain why they need to have terms construed would go a long way toward eliminating unnecessary disputes. Minor disputes over wording choices can also be resolved in this manner. Such telephone conferences can vary in length, from a short call about straightforward matters to a more extended, complex discussion. This telephone conference also provides a further opportunity to discuss whether there are disputed subsidiary facts and how the parties propose presenting evidence.

This process would formally integrate the summary judgment process along with *Markman*. Since claim construction is a matter for the judge (and not a jury),

the *Markman* hearing can resolve disputed facts in advance of summary judgment. The court may wish to schedule summary judgment briefing in tandem with claim-construction briefing, or may wish to stagger summary judgment briefing to take place shortly after the *Markman* hearing. Of course, not all case-dispositive motions are ripe for determination before the completion of fact discovery. Accordingly, and to ensure that the court's ruling can comply with the applicable summary judgment standard (i.e., no genuine issue of material fact), the court should be cautious and limited in the types of case-dispositive motions it entertains at the *Markman* stage.

An open question is whether the courts could penalize a party for failing to take advantage of opportunities to bring summary judgment in connection with the *Markman* process. We expect that parties would take advantage of a formalized summary judgment process in connection with *Markman*, and they should be encouraged to do so. However, there are legitimate reasons why parties might want to defer filing a summary judgment motion until later in the case, even where a claim-construction question is at the heart of the dispute. It might be difficult to craft a summary judgment position until the claim-construction ruling issues. Also, it is frequently desirable to close out fact discovery before filing summary judgment motions, to preclude unforeseen facts being “lobbed in” to defeat a summary judgment motion. Courts should address with care any efforts to penalize a party that does not file an early summary judgment motion in connection with the *Markman* process.

5.1.2.1.5 Recommended Approach: Mandatory Disclosure of Terms Requiring Fact-Finding

The Supreme Court's ruling in *Teva* will likely generate disputes over whether particular claim constructions are amenable to fact-finding or resolved by intrinsic evidence. Courts should consider amending their patent local rules and standing orders to require parties to disclose which claim-construction disputes require district court fact-finding prior to the *Markman* hearing. These disclosures could be made at the same time as the exchange of proposed terms for construction (e.g., N.D. Cal. Patent L.R. 4-1) or upon the exchange of preliminary claim constructions and extrinsic evidence (e.g., N.D. Cal. Patent L.R. 4-2). The disclosure would require parties to identify the terms for which district court fact-finding is necessary and the underlying evidence upon which such fact-finding would be based. The parties would also at this time disclose how they propose proffering that evidence for the court's consideration, be it through a live testimony or documentary submission.

There is a risk that parties may take an all-or-nothing approach to the matter, driven by the standard of review on appeal rather than the particular considerations for each term. That is, a party seeking to limit Federal Circuit review might contend that every term rests on disputed questions of fact as supported by an expert declaration that contests every point. Alternatively, parties might seek to expand the effective scope of appellate review by restricting their claim-construction proposal to intrinsic evidence. Early confrontation with these issues can ferret out gamesmanship and enable the court to build a sound record to support its claim-construction rulings.

It is important to recognize that although many terms in patent claims are beyond a district judge's general experience, scientists and engineers have relatively clear understandings within their fields. In fact, many of the disputed terms that are appealed to the Federal Circuit are not technical or scientific terms but common terms that are disputed within the context of the particular patent claim. *See Anderson & Menell*, 108 Nw. U. L. Rev. at 68. Scientists or engineers who take unjustified positions risk having federal judges impugn their credibility. Since their testimony would not occur before a jury, district judges have substantial leeway to press the experts to clarify their positions. Over time, this possibility should have the desired effect of bringing parties closer together in their allegations.

The *Teva* decision places a greater onus on district judges to understand and explain how they parse claim language. The decision affords them greater flexibility to use familiar tools for resolving factual disputes—presentation of evidence and expert testimony. *See Anderson & Menell*, 109 Nw. U. L. Rev. Online at 197–98. At the same time, it demands that they delineate how disputed subsidiary facts relate to the intrinsic evidence. Ultimately, this framework adds to the reliability of the dispute resolution process by bringing better evidence, more scrutiny, and fuller explication to bear on claim construction.

By carefully preparing for *Markman* hearings, selectively using focused expert testimony to resolve disputed subsidiary facts, and clearly explaining their reasoning, district judges have the ability to achieve effective, transparent, and well-reasoned patent claim constructions. As this process takes root, patent litigation will become more predictable and understandable. We can also hope that more cases will settle sooner, especially after *Markman* rulings.

5.1.2.2 Educating the Court About Underlying Science and Technology

As discussed in §§ 5.2.1 and 5.2.3.2.1, claim terms must be interpreted from the perspective of a person having ordinary skill in the art as of the time the invention was made. Thus, the parties will need to educate the court about the science, technology, and the perspective of a person having ordinary skill in the art as of the time period of the invention. The most common vehicle for accomplishing this task is the use of technology tutorials typically done in connection with a *Markman* hearing. Courts occasionally take a significant further step and appoint a technical advisor, special master, or expert for the court. Table 5.2 summarizes the principal characteristics of these educational aids.

Table 5.2
Educating the Court and Court-Appointed Experts

Nature of Expert/ Legal Authority	Process/Role	Procedural Safeguards
1. Tutorial Process	<ul style="list-style-type: none"> • presented by counsel, experts for each side, or agreed expert • demonstratives often useful (e.g., PowerPoint presentation, simulation video, CD that can be reviewed later) 	<ul style="list-style-type: none"> • typically scheduled within two weeks of <i>Markman</i> hearing • usually best to allow each side to make their own presentation, with court actively questioning • advance disclosure (at least 48 hours) of demonstratives • often useful to videotape proceedings for later review
2. Technical Advisor <ul style="list-style-type: none"> • pursuant to inherent powers. <i>TechSearch v. Intel</i>, 286 F.3d 1360 (Fed. Cir. 2002) (approved for use in <i>Markman</i>) 	<ul style="list-style-type: none"> • “sounding board” and tutor who aids the court in understanding “jargon and theory” • not analogous to law clerk because advisor’s superior technical knowledge can override judge’s prerogative 	<ul style="list-style-type: none"> • fair and open procedure for appointment; address allegations of bias, lack of qualifications • court must clearly define and limit duties in writing • guard against ex parte communications; advisor cannot contribute evidence or conduct independent investigation • make explicit (perhaps through a report or record) the nature and content of the advisor’s tutelage concerning technology
3. Special Master <ul style="list-style-type: none"> • Federal Rule of Civil Procedure 53 	<ul style="list-style-type: none"> • prepares report and recommendations (e.g., proposed claim construction) • court adopts, rejects, or modifies 	<ul style="list-style-type: none"> • parties must be given opportunity to object • court may receive additional evidence • factual and legal issues decided de novo • procedural decisions reviewed for abuse of discretion
4. Expert Witness <ul style="list-style-type: none"> • Federal Rule of Evidence 706 	<ul style="list-style-type: none"> • instructed by court in writing • provides findings to parties and court • court or any party may call expert as a witness 	<ul style="list-style-type: none"> • court must allow parties to present views • may be deposed by any party

5.1.2.2.1 Technology Tutorials

Technology tutorials can be especially helpful in educating the court about the underlying technology. While the issues that the parties are litigating will always

shape tutorials, the goal of the tutorial should be to give the court neutral, useful background information about the technology.

Cases vary widely on the need for technology tutorials. Some cases need little more than a brief introduction by the lawyers at the *Markman* hearing. Others may benefit from a lengthy, separate presentation with animations and live witnesses. With the Supreme Court's recognition in *Teva* that claim construction can entail subsidiary factual findings by the district judge, even in a case where a party has asserted their jury right, the opportunity exists to combine the technology tutorial with a focused evidentiary hearing on disputed subsidiary facts.

A common practice has been to schedule the technology tutorial within two weeks of the *Markman* hearing. It is often best to have the attorneys give the main presentations, with each side's technical expert in attendance for questioning. This approach recognizes that attorneys will generally be the most efficient at tailoring the background technology presentation to the issues the court will confront in *Markman* and throughout the remainder of the case. Having each side's expert in attendance allows the court to ask questions about the science, technical background, and technical terminology. Several courts have successfully utilized what is referred to as the "hot tub" method, in which experts for each side engage in a dialogue. The court moderates the discussion and probes to determine areas of agreement and disagreement. The *Teva* decision authorizes the judge to resolve the dispute based on credibility and corroborating evidence. Courts engaging in such processes should ensure that the testimony becomes part of the record.

Video animations can improve the education process involving complex technologies, which gives the court a tutorial that can be played at any time, including for newly arrived law clerks. However, videos can be costly and time-consuming for the parties and may be less useful than allowing in-court presentations, with the opportunity for live questioning by the court. Some courts videotape in-court tutorials (or use a simple webcam), to achieve the benefits of a live presentation where the court's questions can be answered and a reference copy of the presentation for chambers' use (which captures more than a bare transcript might). The court should ensure that these video recordings are included in the appellate record so as to educate the Federal Circuit about the technology and to enable the Federal Circuit to better understand the basis for the district court's claim construction.

As discussed below, some courts appoint technical experts in patent cases. It is not recommended that the court use a court-appointed expert to deliver the tutorial. Preparing for these tutorials is lengthy and expensive, typically with large investments in graphics and multimedia teaching tools. This function cannot be readily delegated to a court-appointed expert under a cost-sharing agreement by the parties, because the parties would never agree on what should be taught, or how the message should be conveyed. Moreover, allowing a court-appointed expert to present the tutorial would inject substantial uncertainty into the proceedings, and would leave the parties to try to present their own views of the technology through cross-examination of the court-appointed expert (which Federal Rule of Evidence 706 appears to allow), which would detract from the neutral presentation that these tutori-

als contemplate. It is better to allow each side to present their own view of the technology.

5.1.2.2.1.1 Anticipating the Need for an Appellate Record

It is important to bear in mind that the Federal Circuit faces comparable challenges to those encountered by the district court in understanding the background technology in patent cases. The appellate court lacks the opportunity to hear from science and technology experts about the technology directly. Therefore, it will be valuable to preserve background information in a form that could be useful during appellate review. Tutorial videos prepared by the parties can be particularly valuable. In addition, transcripts of hearings and PowerPoint slides (in notebook and digital format if animated) can help the Federal Circuit comprehend the background science and more fully understand the basis for the district court's claim construction. This will be especially important where the court makes subsidiary factual determinations.

5.1.2.2.2 Court-Appointed Experts

Owing to the challenges of understanding the technical issues in particularly complex patent cases, some courts have turned to the appointment of experts. As reflected in Table 5.2, there are three options: (1) technical advisor; (2) special master; and (3) expert witness. These roles vary significantly. In appointing such an expert, it is important that the court specify the particular role that the expert would serve. See *In re Acacia Media Techs. Corp.*, Nos. M 05-1665 JW, C 05-01114 JW, 2010 U.S. Dist. LEXIS 65297, 2010 WL 2179875, at *4 (N.D. Cal. May 25, 2010) (clarifying initial order which stated simultaneously that the expert was being appointed as an expert pursuant to Federal Rule of Evidence 706 and as a consultant to the court, and specifying that the expert was appointed only as “an advisor to assist it on technical matters,” and not as a Rule 706 expert).

5.1.2.2.2.1 Technical Advisor

One option that courts may consider for *Markman* proceedings is to appoint a technical advisor. Because *Markman* proceedings demand that claims be construed from the perspective of a person of ordinary skill in the art, there can be an appropriate role for technically skilled persons to assist the court, particularly in technologically complex cases. See generally John Shepard Wiley, Jr., *Taming Patent: Six Steps for Surviving Scary Patent Cases*, 50 UCLA L. Rev. 1413 (2002). The Federal Circuit expressly approved appointing a technical advisor for *Markman* proceedings in *TechSearch LLP v. Intel Corp.*, 286 F.3d 1360 (Fed. Cir. 2002), although the court emphasized the need to establish “safeguards to prevent the technical advisor from introducing new evidence and to assure that the technical advisor does not influence the district court's review of the factual disputes.” *Id.* at 1377. Applying Ninth Circuit law, the Federal Circuit noted the following guidelines for appointing a technical advisor: use a fair and open procedure for appointing a neutral technical advisor addressing any allegations of bias, partiality, or lack of qualifications; clearly define and

limit the technical advisor's duties in a writing disclosed to all parties; guard against extra-record information; and make explicit, perhaps through a report or record, the nature and content of the technical advisor's tutelage concerning the technology. *Id.* at 1379 (citing *Ass'n of Mexican Am. Educators v. California*, 231 F.3d 572, 611 (9th Cir. 2000) (en banc)). The Federal Circuit cautioned, however, that "district courts should use this inherent authority sparingly and then only in exceptionally technically complicated cases." *Id.* at 1378. (We discuss this option with regard to trial case management in § 8.1.2.4.)

The advisor's proper role is that of a sounding board or tutor who aids the judge's understanding of the technology. This includes explanation of the jargon used in the field, the underlying theory or science of the invention, or other technical aspects of the evidence being presented by the parties. The advisor can also assist the judge's analysis by helping think through critical technical problems. In this latter function, the court must be careful to assure that the decision making is not delegated to the advisor.

A common concern with the appointment of a technical advisor is that the judge may surrender the application of the legal rules of claim construction to the technical expert who could then have undue influence over the proceedings. Although in form the relationship between a judge and a technical advisor is much like the interaction between a judge and law clerk, the former relationship differs in that, because of a judge's knowledge of law, a clerk cannot usurp the judicial role. Unlike the judge's law clerk, who may have undergraduate and possibly some graduate training in the relevant field and understands his or her role in assisting the judge through legal education and familiarity with the judicial system, a technical advisor will typically be a nationally or internationally known scientist or engineer with limited exposure to legal institutions. They are less likely to appreciate the nature of judicial decision making and the unique, constitutionally grounded authority of the court. Perhaps recognizing that parties often do not voluntarily raise these issues to the court, some judges now include in their standard scheduling order a date for parties to submit agreed-upon names of technical advisors.

A related concern with the use of court-appointed advisors for claim construction is that they distance the judge from some of the most important decisions relating to the case. It is essential for the court to engage fully in the interpretation of claim language. These determinations often play a decisive role in the litigation, may require adjustment or further analysis later in the case, and affect the conduct of the trial (e.g., relevance of expert testimony, jury instructions, what arguments can be made to the jury). For this reason, some experienced patent jurists have disavowed the use of advisors in claim construction and caution against their use.

A third concern relates to the transparency of the technical advisor process. The *TechSearch* decision emphasizes the need to guard against extra-record information and make explicit the nature and content of the technical advisor's tutelage on the technology. These principles run counter to using the technical advisor in the same manner as a law clerk, in which the court has informal, off-the-record communication with a member of his or her staff. A technical advisor is not a member of the court's staff. One solution to this concern would be to have all interactions between

the judge and the technical advisor in open court with counsel present. Such a procedure, however, could make use of the technical advisor so inconvenient and costly as to render it infeasible. An alternative approach is to have all interactions between the court and the technical advisor transcribed, along with a record made of all correspondence, documents reviewed, and other materials considered by the technical advisor and discussed with the court. A third variation on this alternative, used by at least one court, is to have transcripts of interaction between the court and the technical advisor sealed and released to the parties only after the trial court proceedings have concluded. This approach allows the court some flexibility in its use of the technical advisor while assuring that the parties will have a full opportunity to review that interaction prior to potential appeal.

5.1.2.2.2 Special Master

Some courts, pursuant to Federal Rule of Civil Procedure 53, have delegated initial consideration of claim construction to a special master. Such special masters often have general legal training as well as experience with patent law specifically. They might also be familiar with the technical field in question. The special master will typically conduct a claim-construction process with briefing and argument. The special master will then prepare a formal report with recommendations regarding the construction of disputed claim terms. After the parties have had an opportunity to object to that report, the court will often conduct a hearing at which the court may receive additional evidence and then adopt, reject, or modify the recommended claim constructions. For example, a special master for claim construction was appointed with the parties' consent in *Paone v. Microsoft Corp.*, 771 F. Supp. 2d 224, 229 (E.D.N.Y. 2011) (appointing an "experienced and well-regarded patent attorney" as special master for the limited purpose of conducting a *Markman* hearing and issuing a report and recommendation to the court on claim construction). *See also Tech. Licensing Corp. v. Technicolor USA, Inc.*, 2010 U.S. Dist. LEXIS 113292, 2010 WL 4292275, *1 (E.D. Cal. 2010); *Philip M. Adams & Assocs., LLC v. Dell Inc.*, 2010 U.S. Dist. LEXIS 68749, 2010 WL 2733319, *1 (D. Utah 2010) (appointing special master for claim construction over plaintiff's objection).

The use of a special master for claim construction alleviates some of the due process concerns inherent in the use of a technical advisor. The special master does not communicate off the record with the court. On the other hand, the use of a special master runs an even greater risk of distancing the court from the details of claim construction. This limits the court's involvement in some of the most critical aspects of many patent cases and can create problems should claim construction require adjustment later in the case. It may limit the court's ability to gain command over the background science and technology, which could be important later in the case (for example, to address nonobviousness).

5.1.2.2.3 Expert Witness

A third option is the formal appointment of an expert pursuant to Federal Rule of Evidence 706. *Cf.* § 2.6.6 (discussing the use of court-appointed damages experts).

This procedure is not usually appropriate for the *Markman* process. It is the court's responsibility to make the ultimate *Markman* determination, even if it appoints a special master. The parties have a significant stake in crafting their presentation of the issues, which is often related to the tutorial process. Furthermore, the process leading up to and the timing of *Markman* decisions caution against the use of a court-appointed expert witness. The list of disputed claim terms will evolve as the case moves to the *Markman* hearing. Selecting and instructing a court-appointed expert could complicate an already-involved and rapidly evolving process. A court-appointed expert for the *Markman* hearing would also create significant redundancy since the parties will have their own experts to the extent such assistance is needed. The court can and should encourage the parties to identify a mutually agreeable expert to educate the court, although experience indicates that parties rarely agree on such a person.

5.1.3 Conduct of the *Markman* Hearing

As courts have experimented with *Markman* hearings, they have had to determine how such proceedings should be characterized and what rules apply.

5.1.3.1 The “Evidentiary” Nature of *Markman* Hearings

The “evidentiary” nature of *Markman* hearings has been hotly contested since their inception. The Supreme Court's *Teva* ruling established that district courts may conduct evidentiary fact-finding to support their claim-construction rulings. However, there is no requirement for district courts to do so—they may base their rulings on evidence intrinsic to the patent, in which case the *Markman* process is a question of law. District courts may also decide to base their rulings on evidence extrinsic to the patent, in which case the subsidiary basis or bases are entitled to deference on appeal.

We can expect an interesting interplay between the district courts and the Federal Circuit as to which terms garner deference on appeal and to what extent. It is clear that if a claim construction is based solely on intrinsic evidence, then it will receive de novo review on appeal. Likewise, if a claim term not explained in the intrinsic record and appears to have meaning to skilled artisans, then it will be necessary to find the meaning of this term through extrinsic evidence “in order to understand, for example, the background science or the meaning of a term in the relevant art during the relevant time period”—in this situation deferential review would govern. *Teva*, 135 S. Ct. at 841.

There will inevitably arise, however, situations where the intrinsic record is sufficient to resolve the claim-construction dispute, and one or both parties marshal expert testimony to buttress their contentions. In this circumstance, the expert testimony may do no more than “pile on” to the intrinsic record. District courts may prefer to rely on that expert testimony to garner deference on appeal. So that the Federal Circuit credits that fact-finding as necessary to the ruling, district courts should make clear that the expert testimony adds to the analysis and is not simply

cumulative of the intrinsic record. As noted in § 5.1.2.1.5, advance planning of the fact-finding process, through amendment of the patent local rules' disclosures, may help district courts structure this process and determine in advance if an evidentiary hearing will be necessary.

Extrinsic evidence cannot be used to override the intrinsic evidence. *See* § 5.2.2.1. Likewise, conclusory expert opinions will be disregarded. *See* § 5.2.2.2. Thus, deference on appeal may not be available if the Federal Circuit determines that the intrinsic evidence controls. Thus, fact-finding by the district courts should strive to determine if and why the intrinsic evidence is not sufficient to resolve disputed issues.

5.1.3.2 Application of the Federal Rules of Evidence

A frequent and related question is whether, and to what extent, courts should apply the Federal Rules of Evidence in *Markman* proceedings. The dominant and recommended approach is to apply the Federal Rules of Evidence loosely, in part because juries do not hear *Markman* hearings. Furthermore, requiring available witnesses to appear live at a *Markman* hearing and discovery to overcome hearsay and other objections would significantly increase the cost and burden of conducting the hearing. Thus, absent particular concerns about the unreliability of certain forms of proffered evidence, we recommend a liberal approach to applying the Federal Rules of Evidence in *Markman* proceedings, such as allowing use of depositions instead of live testimony and declarations (as long as there has been an opportunity for cross-examination) and freer use of documents without a foundational witness as long as there is no dispute about the document's authenticity.

The court should bear in mind, however, that the evidentiary basis for subsidiary fact-finding will come under closer scrutiny on appeal. This issue did not arise prior to the *Teva* decision, but is now pertinent to evaluation of whether the district court's subsidiary factual findings are "clearly erroneous." Fed. R. Civ. P. 52(a)(6). Therefore, district judges making factual findings as part of their *Markman* rulings should endeavor to build a sound evidentiary record.

5.1.3.3 Safeguards on Extrinsic Evidence

The court should provide safeguards to ensure that extrinsic evidence is reliable. Allowing depositions of experts prior to a *Markman* hearing reduces this risk and may eliminate the need to call witnesses at the *Markman* hearing. If expert testimony occurs, parties should be permitted to cross-examine any witnesses and allow examination into any sources of documentary evidence that may be proffered. Courts need to scrutinize expert submissions and should actively question the opinions of experts. Typically, experts are highly paid consultants, and there is an inherent risk that their opinions will be biased and unreliable. Thus, while it may be extremely probative to hear from persons who are truly experts in the particular field of technology at issue, courts must actively guard against the risk of bias. Cross-examination will usually be sufficient to expose bias and unreliability, and converse-

ly, to confirm that an expert's opinions are sound. Courts may choose to apply a *Daubert* standard for qualifying expert witnesses to present expert opinions in a *Markman* hearing. Because a jury does not hear *Markman* hearings, the need for applying *Daubert* is not as compelling as for a jury trial. It would, however, be within the trial court's discretion to exclude any testimony of a witness whose proffered opinions lack the hallmarks of reliability and relevance that *Daubert* mandates.

5.1.3.4 Evidence of the Accused Device

Another common question is whether, and to what extent, the court should consider the accused device during the *Markman* hearing. In theory, the accused device should have no role in the *Markman* process because the claims should be construed based on the patent language and relevant supporting documentation. Older en banc authority from the Federal Circuit holds that the accused device should not be considered during claim construction. See *SRI Int'l v. Matsushita Elec. of Am.*, 775 F.2d 1107, 1118 (Fed. Cir. 1985) (en banc) ("It is only *after* the claims have been *construed without reference to the accused device* that the claims, as so construed, are applied to the accused device to determine infringement."). More recently, the Federal Circuit expressly approved consideration of the accused device during claim construction. *Wilson Sporting Goods Co. v. Hillerich & Bradsby Co.*, 442 F.3d 1322, 1327 (Fed. Cir. 2006); *Pall Corp. v. Hemasure Inc.*, 181 F.3d 1305, 1308 (Fed. Cir. 1999) ("Although the construction of the claim is independent of the device charged with infringement, it is convenient for the court to concentrate on those aspects of the claim whose relation to the accused device is in dispute."); see also *Every Penny Counts*, 563 F.3d at 1384 (quoting *Aero Prods. Int'l, Inc. v. Intex Recreation Corp.*, 466 F.3d 1000, 1012 n.6 (Fed. Cir. 2006)) ("Although the court revealed an awareness of the accused device, the court's awareness of the accused device is permissible."). As this more recent authority stresses, it is often useful for trial courts to understand the context of the infringement dispute to know what they are deciding when ruling on claim construction. Moreover, knowing the context of the infringement (or validity) dispute gives courts a better sense of whether they even need to construe a term, or if they can simply let the "plain meaning" of a term speak for itself. Nonetheless, the accused device has no relevance to how a person having ordinary skill in the art would interpret claim terms.

5.1.3.5 Evidence of the Prior Art

Relatedly, courts are free to consider the prior art when ruling on claim construction. Prior art may be directly relevant to claim construction, especially where the patent applicant's dialogue with the USPTO concerning the prior art may have given rise to a disclaimer. Also, statements in the patent specification about the prior art may be important evidence for construing claim terms. Even apart from prior art recited in the patent and the prosecution history, it is important for trial courts to have the context of other prior art that will form the basis of an invalidity defense.

Those prior art references may play as large a role in shaping the claim-construction dispute as does the accused device.

5.1.3.6 The Need to Focus *Markman* Proceedings on Claim Interpretation

There are limits on the extent to which the court should consider the accused device and prior art during *Markman* proceedings. The *Markman* case seeks to establish distinct roles for the court and the jury.¹ It is the court's job to perform the legal task of interpreting the scope of the claim terms to the extent possible based upon the patent document from the perspective of a person having ordinary skill in the art. It is the role of the fact-finder (typically the jury) to apply these construed terms to the accused device (to determine infringement) and to the prior art (to determine validity). If the court prejudices infringement or validity in its *Markman* ruling, then the court is subject to reversal for having usurped the role of the jury.² See *Am. Piledriving Equip., Inc. v. Geoquip, Inc.*, 637 F.3d 1324 (Fed. Cir. 2011) (“It is well settled that the role of a district court in construing claims is not to redefine claim recitations or to read limitations into the claims to obviate factual questions of infringement and validity but rather to give meaning to the limitations actually contained in the claims, informed by the written description, the prosecution history if in evidence, and any relevant extrinsic evidence.”). As we see below, these roles can become blurred in the context of nontechnical claim terms and terms of degree. See §§ 5.2.3.1.5.1–5.2.3.1.5.2. Following the *Markman* ruling, the court is free to entertain summary judgment motions that turn on claim construction. As discussed further in Chapter 6, we recommend that courts schedule summary judgment motions that can be resolved on the basis of claim construction simultaneously with claim-construction hearings. Nonetheless, it will be important for the court to avoid trenching upon the jury's role.

1. See *MacNeill Eng'g Co. v. Trisport, Ltd.*, 126 F. Supp. 2d 51, 54 n.1 (D. Mass. 2001) (“To open *Markman* hearings to detailed comparisons between the patented and allegedly infringing device creates the unacceptable risk of conflating claim construction (law teaching) with infringement (fact finding). Let's face it, when *Markman* hearings become miniature or full blown infringement trials, the actual *language* of the claim diminishes in importance relative to the *context* of the particular dispute, despite the Supreme Court's admonition that it was the judiciary's particular facility for construing *language* that warranted denoting claim construction as a legal, and hence judicial, function.”).

2. See *PPG Indus. v. Guardian Indus. Corp.*, 156 F.3d 1351, 1355 (Fed. Cir. 1998) (“Claims are often drafted using terminology that is not as precise or specific as it might be That does not mean, however, that a court, under the rubric of claim construction, may give a claim whatever additional precision or specificity is necessary to facilitate a comparison between the claim and the accused product. Rather, after the court has defined the claim with whatever specificity and precision is warranted by the language of the claim and the evidence bearing on the proper construction, the task of determining whether the construed claim reads on the accused product is for the finder of fact.”).

5.1.3.7 Sequence of Argument

Courts have broad discretion as to how they conduct *Markman* hearings. Some allocate multiple days to the hearing, while others determine claim construction on the papers. When there is an oral hearing, it may be appropriate to hear from the lawyers on a term-by-term basis. Particularly when there are many terms at issue, hearing each side’s positions for each term can help crystallize the dispute for each term. In other cases, it makes sense for each side to give its complete presentation. Allowing each party to do so may be a better way to appreciate the overall themes of a case. Hybrid approaches may work as well, with the court hearing from each side on groups of terms.

It is highly recommended that courts allow the parties to make visual presentations. Multimedia presentations, animations, and other visual aids can be highly instructive tools for teaching the technological concepts and claim-construction principles that shape a dispute. They are also especially helpful in illustrating the particular issues in dispute. To the extent possible, the court should endeavor to preserve this record for appellate review.

Table 5.3 lists some questions that the court may want to ask of the parties during the argument.

Table 5.3
Important Questions During *Markman* Hearing

Why do I need to construe this term?
How does your proposal differ from that of your opponent?
What is the source of ordinary meaning for this term?
Do I need to find an intentional disclaimer (if seeking narrowing construction)?
Does the extrinsic evidence contradict the language of the patent or other intrinsic evidence?
Is the proffered extrinsic evidence simply cumulative of the intrinsic evidence?
Do I need to perform fact-finding to construe this term?

5.1.3.8 Claim Construction in Multidefendant Disputes

Multidefendant disputes pose particular case-management challenges. The defendants may be sued in the same proceeding, or in different proceedings, either before the same judge or in different jurisdictions. The cases may track closely in time, or be staggered by years. Performing claim construction in a manner that fairly accommodates the interests of the plaintiff, the various defendants, and the court is a case-dependent challenge.

Multidefendant disputes have become a far greater case-management challenge with the passage of the America Invents Act. That legislation prohibits joinder of multiple defendants in a single suit for trial unless the defendants are accused of exploiting the “same accused product or process.” § 299; *see* § 2.2.2.1.1. Plaintiffs must sue defendants in separate actions absent a common accused product or process, and

such matters may not be consolidated for trial. While the statute mandates that each defendant get its own trial, it is silent as to pretrial case management. The motive behind Congress's legislation was to discourage multidefendant suits by making it harder and more costly for nonpracticing entities to wage a litigation campaign against large numbers of defendants at once. It also sought to afford defendants adequate opportunity to present their particular defenses, which was difficult in a large multidefendant trial subject to tight time constraints.

Congress's reform has imposed considerable burdens on the courts. Courts, and consequently plaintiffs, have reacted in a variety of ways. Although no settled procedure has been established, several approaches have emerged, each with its own limitations.

In one approach, each judge will issue his or her own *Markman* ruling, and will handle the litigation on its own separate track. An example is the series of cases brought by MasterObjects against Google, Yahoo!, and eBay. A different judge of the Northern District of California handled each case, and three separate *Markman* rulings were issued. 2013 U.S. Dist. LEXIS 74767, 2013 WL 2319087 (Google); 2013 U.S. Dist. LEXIS 168296, 2013 WL 6185475 (Yahoo!); 2013 U.S. Dist. LEXIS 47001, 2013 WL 1287428 (eBay). While the plaintiff won favorable constructions against Yahoo! and eBay, Google won a case-dispositive construction. When the plaintiff stipulated to noninfringement against Google and appealed, the other courts stayed their actions. When Google's construction was upheld on appeal, all three cases were subsequently dismissed. *MasterObjects, Inc. v. Google Inc.*, 582 F. App'x 893 (Fed. Cir. 2014). Thus, the trailing litigations were stayed and subsequently dismissed, following the developments in the lead case against Google.

In another example, *Body Science v. Boston Scientific*, the five-defendant case filed in the Northern District of Illinois was initially split into five separate litigations in different states. The case-management challenges of five separate litigations predominated, and the case was subsequently recentralized through a multidistrict litigation (MDL) proceeding in Massachusetts, citing discovery coordination and *Markman* consistency as the driving factors. See *In re Body Sci. Patent Litig.*, 883 F. Supp. 2d 1344, 1345 (2012) (MDL No. 2375) ("Centralization, however, will allow a single judge—as opposed to the now five judges in five districts—to preside over discovery relating to the two patents at issue (which will inform and aid the consistent construction of the patents' claims and to consistently rule on challenges to the validity of those patents)."). Having multiple courts each conduct their own pretrial proceedings, including *Markman* hearings, can be criticized as inefficient. Courts can either stay trailing cases for what will likely be prolonged delays while the lead case resolves, or proceed independently, duplicating efforts with a high risk of reaching divergent rulings.

Another approach allows the plaintiff to file multiple suits in a single court and holds the defendants' transfer motions in abeyance until the *Markman* ruling issues. *PersonalWeb Technologies* first employed this approach in litigation against numerous technology companies in the Eastern District of Texas, where, with the approval of the Northern District of California, the Texas court provisionally granted the defendants' transfer motions, to take effect once the *Markman* ruling issued. See *Per-*

PersonalWeb Techs., LLC v. Facebook, Inc., 2014 U.S. Dist. LEXIS 4095, 2014 WL 116340 (N.D. Cal. Jan. 13, 2014). This was repeated in the *Norman IP Holdings* litigation, where the plaintiff sued Lexmark in the Eastern District of Texas one day before the America Invents Act (AIA) became law, then sued twenty-two additional defendants shortly thereafter in the same court. The court deferred the defendants' transfer motions through the *Markman* proceedings, citing the administrative challenges of coordinating twenty-three separate proceedings:

In response to the AIA's joinder provision, plaintiffs now serially file multiple single-defendant (or defendant group) cases involving the same underlying patents. This presents administrative challenges for the Court and, left unchecked, wastes judicial resources by requiring common issues to be addressed individually for each case.

Norman IP Holdings, LLC v. Lexmark Int'l, Inc., 2012 U.S. Dist. LEXIS 112757, 2012 WL 3307942, *4 (E.D. Tex. 2012).

This approach can be criticized for trumping meritorious transfer motions that are deferred until the end of potentially case-dispositive claim-construction proceedings. It also overrides the trend to allow defendants to transfer back to their home districts, as promoted by the Federal Circuit's series of venue rulings in *TS Tech* and its progeny. *In re TS Tech U.S. Corp.*, 551 F.3d 1315 (Fed. Cir. 2008). Nonetheless, the approach of *PersonalWeb* and *Norman IP* does provide a potential mechanism for managing the logistical problems created by Congress's misjoinder reform.

Another approach is to coordinate pretrial management MDL proceedings. *See, e.g., In re Bear Creek Techs., Inc., ('722) Patent Litig.*, 858 F. Supp. 2d 1375 (2012) (MDL No. 2344) (centralizing fourteen actions pending in three districts for pretrial proceedings). Centralizing pretrial proceedings through an MDL transfer may be the best answer for balancing the need for coordinated case management with fairness to the defendant (which may otherwise be eligible for transfer back to a home district) in complex, widespread, multidefendant patent assertions. The selection of a court with expertise in coordinating multidefendant cases could address the concerns associated with deferral of transfer motions as reflected in the *Norman IP* litigation. Furthermore, centralizing proceedings through MDL allows for a more orderly wrap-up of the coordinated proceedings, as opposed to the *Norman IP* approach which terminates upon the court's issuance of the *Markman* order (which may trigger a transfer at an unforeseen time). *See, e.g., In re Protegrity Corp.*, 2015 U.S. Dist. LEXIS 14291, 2015 WL 506373 (MDL No. 2600, Feb. 6, 2015) (centralizing pretrial procedures for seventeen actions in N.D. Cal. to eliminate duplicative discovery and prevent inconsistent pretrial rulings). Like the other approaches discussed above, the MDL approach has its own drawbacks. The pretrial proceedings are conducted in a remote court such that the eventual trial judge might have little or no background in the case.

There are sound justifications for holding consolidated *Markman* hearings, particularly where the plaintiff asserts the same patent against multiple defendants. The intrinsic and extrinsic evidence should be the same in all cases, as will be the universe of prior art that bears on claim construction. The accused devices are generally irrelevant to claim construction. The plaintiff will generally want to conduct only a

single *Markman* hearing, and often it will be in the court's interest to hold a single hearing as well.

The defendants' interests may range widely depending on the case. Although the accused devices are not directly relevant to claim scope, the nature of the accused devices certainly affects the terms to be disputed, as well as how the parties shape their proposed constructions. It may be advantageous for the various defendants to be present in a single, consolidated proceeding so that each may be heard when the court first engages in the dispute. Alternatively, having separate proceedings may be best for allowing each defendant to express the unique aspects of its own position. For a defendant in this latter scenario, going second risks that the court may have already settled on a position developed in the earlier case, which the court may be reluctant to change, even if the later case justifies adjustment.

Particularly where cases are pending in separate courts, there may be benefits to holding separate *Markman* hearings, so that each court has an opportunity to assess the claim construction. Claim construction is so foundational to the merits of a case that a court may be reluctant to cede control over the process to a multidistrict proceeding, particularly where different terms may be at issue in the different cases. On the other hand, litigating claim construction through a consolidated MDL proceeding promotes uniformity of claim interpretation across the various actions, which may be important for resolving the overall dispute between the parties and promoting settlement. Having different courts arriving at different constructions renders the disputes more complex, and may drag out the process for determining "who won" until the various conflicting constructions are eventually resolved on appeal. See, e.g., *Am. Piledriving Equip.*, 637 F.3d at 1326–27 (appeal over seven underlying cases in several different jurisdictions, affirming some constructions and reversing others). Thus, whether or not to consolidate the claim construction through a single MDL proceeding depends on the case, and courts have wide discretion to approach consolidation of claim construction as the demands of the case dictate.

5.1.4 The *Markman* Ruling

5.1.4.1 Interrelationship to Jury Instructions

The *Markman* ruling becomes the basis for the court's jury instructions. *AFG Indus., Inc. v. Cardinal IG Co.*, 239 F.3d 1239, 1247 (Fed. Cir. 2001) ("It is critical for trial courts to set forth an express construction of the material claim terms in dispute, in part because the claim construction becomes the basis of the jury instructions, should the case go to trial."). Parties often propose claim constructions that use technical and complex language. Although such proposals may constitute accurate constructions, they are not helpful if read to a jury. Parties should be required to propose constructions in the specific language they want the court to read to the jury. Courts should draft their *Markman* rulings with an eye toward making the claim terms understandable to the jury when the time comes for instructions. In this regard, it is highly recommended that courts end their *Markman* orders with a conclusion that sets forth the exact construction that the jury instructions will use. Any lack

of clarity in this regard invites further disputes in the midst of trial during the drafting of jury instructions.

5.1.4.2 Basis for Appellate Review

The court should provide a detailed explanation for the basis for its ruling. This is all the more critical under the Supreme Court’s ruling in *Teva*, which provides for deference on review of district court fact-finding. District courts seeking such deference on appeal should deliberately recite factual findings that underlay their constructions. It is only the district courts’ fact-finding, not their ultimate constructions, that is entitled to deference on appeal. *See Teva*, 135 S. Ct. at 841 (“The appellate court can still review the district court’s ultimate construction of the claim *de novo*.”).

The district court should also scrutinize the factual stipulations that underlie summary judgment motions following or in combination with claim construction. The parties may enter into such stipulations so as to obtain finality of the district court proceedings and secure appellate review (such as the patentee stipulating to noninfringement after receiving a narrow claim construction). If the stipulation is devoid of context, or overly vague and ambiguous, the Federal Circuit may lack the context it needs to resolve the appeal, including making decisions on whether to remand the case. Accordingly, the district court should be vigilant to ensure that any such stipulations provide the necessary facts to justify the finality of the judgment below.³

5.1.4.3 Not All Terms Require “Construction”

There is no requirement that a court construe a claim term when there is no genuine dispute about its meaning. *See O2 Micro*, 521 F.3d at 1362. (“[D]istrict courts are not (and should not be) required to construe every limitation present in a patent’s asserted claims.”). Claim construction aims to define the proper scope of the invention and to give meaning to claim language when the jury might otherwise misunderstand a claim term in the context of the patent and its file history. If a claim term is nontechnical, is in plain English, and derives no special meaning from the patent and its prosecution history, then the court need not function as a thesaurus. *See* § 5.2.3.1. To do so could well encroach upon the fact-finder’s domain. The “ordinary” meaning of such terms should speak for itself, and the court should avoid

3. Parties do not need to continue asserting their rejected claim construction, post-*Markman*, to preserve the issue for appeal. Rather, it is appropriate for a party to make its subsequent arguments, for example, during pre- or posttrial briefing, within the confines of the district court’s construction. *See O2 Micro Int’l*, 521 F.3d at 1359; *Smith & Nephew Inc. v. Arthrex Inc.*, 355 F. App’x 384 (Fed. Cir. 2009). However, a stipulation of infringement that does not state that it is contingent on claim construction will be binding, and cannot be altered by a modified claim construction. *See Fresenius USA Inc. v. Baxter Int’l Inc.*, 582 F.3d 1288, 1304 (Fed. Cir. 2009).

merely paraphrasing claim language with less accurate terminology. *See, e.g., U.S. Surgical Corp. v. Ethicon, Inc.*, 103 F.3d 1554, 1568 (Fed. Cir. 1997) (“Claim construction is a matter of resolution of disputed meanings and technical scope, to clarify and when necessary to explain what the patentee covered by the claims, for use in the determination of infringement. It is not an obligatory exercise in redundancy.”); *see also Perfect Web Techs. v. InfoUSA Inc.*, 587 F.3d 1324, 1332 (Fed. Cir. 2009) (“[A] district court need not construe *undisputed* claim terms prior to issuing a summary judgment of invalidity.”). By contrast, the terms most appropriate for construction are technical terms for which the jury may not appreciate an “ordinary” meaning. Likewise, when the parties present a fundamental dispute regarding the scope of a claim term, it is the court’s duty to resolve it. *Silicon Graphics, Inc. v. ATI Techs., Inc.*, 607 F.3d 784, 798 (Fed. Cir. 2010) (quoting *O2 Micro*, 521 F.3d at 1362); *but see Finjan, Inc. v. Secure Computing Corp.*, 626 F.3d 1197, 1207 (Fed. Cir. 2010) (rejecting the argument that district court “shirked its responsibility to construe a disputed claim term by adopting ‘plain and ordinary meaning,’” in part because the court took measures to prevent the jury from reconstructing the term). It is the role of the court to use the *Markman* process to understand the “ordinary” meaning that persons of skill would give to the claim terms in the context of the patent. Using that ordinary meaning, the court should construe the term in light of the intrinsic and noncontradictory extrinsic evidence.

5.1.4.4 The Court May Adopt Its Own Construction

The court is free to devise its own construction of claim terms rather than adopt a construction proposed by either of the parties. However, the consequence of the court issuing its own construction is that it may upset the foundations of the parties’ expert reports and any pending motions before the court. This problem may be particularly acute in late-phase *Markman* hearings where the parties’ experts may have already rendered reports based on the particular wording of the parties’ proposed constructions. In such circumstances, departing from the parties’ proposed constructions may throw a case off track by requiring new expert reports and redrafting of case-dispositive motions.

5.1.4.5 Tentative Rulings Prior to the *Markman* Hearing

Many courts report success with issuing tentative rulings prior to the *Markman* hearing. The ability to follow this approach is naturally constrained by the resources of chambers to issue a tentative ruling in advance of the *Markman* hearing. It may also be infeasible where the invention involves complex science and technology. The court may understandably wish to hear from experts and see demonstrative exhibits before opining, even if only tentatively.

A tentative prehearing ruling allows the court to inform the parties of the issues that are most important to the court, in order to most effectively channel the in-court presentations at the *Markman* hearing. This approach enables the court to confirm its understanding of the record and the governing authorities in a direct

dialogue with the attorneys. Issuing a tentative ruling prior to the hearing is a good way for the court to clear up any misperceptions that might otherwise result in reversible error. But given that the court may not be familiar with the science and technology at issue and that claim construction can blur the distinction between fact and law, the court should view its tentative position with less conviction than might be the case in other areas of the law.

5.1.5 Amendments to Infringement and Invalidity Contentions

The court's *Markman* ruling can alter the landscape for a party's infringement or invalidity contentions. Accordingly, for those courts that employ patent local rules, or provide for similar provisions in their scheduling orders, it is appropriate to allow limited amendments to a party's infringement or invalidity contentions to account for the *Markman* ruling or other events that may arise during discovery (such as newly discovered prior art, or newly discovered, nonpublic information about the accused devices). See N.D. Cal. Patent L.R. 3-6. Such amendments, however, should only be allowed on a showing of good cause. Freely allowing such amendments would invite litigants to change the playing field late in the case and disrupt the orderly framework that the patent local rules are designed to establish.

5.1.6 Interlocutory Appeal of *Markman* Rulings

The Federal Circuit has long resisted reviewing *Markman* rulings until there has been a final judgment of all claims and counterclaims. In the decade following the *Markman* case, various parties attempted to appeal *Markman* rulings prior to obtaining a final judgment on an interlocutory basis without success. Arguments in favor of such early appeals noted that claim construction is a matter of law (during the *Cybor* era) and that obtaining a definitive claim construction from the Federal Circuit could avoid the costs to all parties of a trial on a multitude of issues that hinge on claim construction. Moreover, given the relatively high rate of reversal of claim-construction rulings at the time, trial rulings frequently needed to be vacated when the claim construction changed on appeal, even in part. Thus, parties contended that early appeals of claim-construction rulings should be allowed to avoid expending time and money (including the trial court's own resources) to resolve issues that likely could be disposed of when claim construction is determined on appeal.

Nonetheless, the Federal Circuit denied all interlocutory appeal petitions during the decade following the *Markman* decision and generally discouraged bringing of such appeals. The Federal Circuit was reluctant to accept early appeals of *Markman* rulings in part because claim construction is frequently not finished until a trial is complete. It is routine for additional *Markman* issues to arise during trial—either based on new claim-construction issues, or the all-too-frequent exercise of “construing the construction,” when the initial claim construction of a court does not squarely resolve the issues presented for trial. Furthermore, because claim construction implicates so many issues in a case, the Federal Circuit is leery of giving an early rul-

ing on claim construction when still unaware of its implications for other issues. Seeking Federal Circuit review of an interim ruling also disrupts the underlying litigation because such appeals would be handled on the Federal Circuit's regular appeal schedule, without expedited relief.

In 2008, however, the Federal Circuit granted interlocutory appeal of a *Markman* ruling, see *Regents of the Univ. of Cal. v. DakoCytomation Cal., Inc.*, 517 F.3d 1364 (Fed. Cir. 2008), although the circumstances were somewhat unusual. This 2008 ruling has not changed the general rule that the Federal Circuit strongly disfavors interlocutory review of claim-construction rulings. *Portney v. CIBA Vision Corp.*, 401 F. App'x 526, 529 (Fed. Cir. 2010) ("Here, we see no reason to depart from our general practice of waiting until final judgment has issued to resolve ordinary claim construction issues."); *St. Clair Intellectual Prop. Consultants, Inc. v. Nokia Corp.*, 395 F. App'x 707 (Fed. Cir. 2010) (same). Indeed, the Federal Circuit has not accepted any subsequent interlocutory appeals of *Markman* rulings to date. Nonetheless, this case-management option may be appropriate in limited circumstances.

Procedurally, litigants have had the most success obtaining early appellate review when the *Markman* ruling renders the claims noninfringed. The parties may at that point stipulate to noninfringement, and ask the trial court to enter final judgment as to noninfringement under Federal Rule of Civil Procedure 54(b). On occasion, the Federal Circuit has granted review of partial judgments entered under Rule 54(b). See *Lava Trading, Inc. v. Sonic Trading Mgmt., LLC*, 445 F.3d 1348, 1350 (Fed. Cir. 2006). However, because the issues of invalidity and unenforceability generally remain pending below, the Federal Circuit commonly will deny such review. See *Linear Tech. Corp. v. Impala Linear Corp.*, 31 F. App'x 700 (Fed. Cir. 2002). At least one judge has remarked that allowing such piecemeal review of issues "portends chaos in process." *Lava Trading*, 445 F.3d at 1355 (Mayer, J., dissenting). Litigants seeking to invoke such review can maximize their chances by fully describing the basis for noninfringement to allow for meaningful review of that ruling on appeal. See *id.* at 1350. Furthermore, parties can facilitate review by dismissal of remaining claims. See *Nystrom v. TREX Co.*, 339 F.3d 1347, 1351 (Fed. Cir. 2003).

5.1.7 Application of the *Markman* Ruling to Trial

As noted above, the central role of the *Markman* ruling at trial is to define the jury instructions. The *Markman* ruling establishes the claim limitations that must be met to infringe the patent and for the prior art to invalidate the patent. The *Markman* ruling also establishes the scope of the claims that the patent must enable to be valid, and it defines the scope of art that the patentee must have disclosed to the PTO during prosecution. Thus, the *Markman* ruling is critical to most of the substantive matters of patent law in the jury instructions. Having a clear, concise *Markman* ruling, which spells out the final constructions for disputed claim terms, is essential to avoiding disputes at trial over the jury instructions. It is useful to place these constructions in a summary conclusion at the end of an opinion so that they can be readily adapted into jury instructions. Instructions on claim construction must come

from the court, and attorneys must not be permitted to reargue claim-construction positions inconsistent with the court's instructions. To do otherwise risks the order of a new trial or reversal. See *CytoLogix*, 424 F.3d at 1172 (“[B]y agreement the parties also presented expert witnesses who testified before the jury regarding claim construction, and counsel argued conflicting claim constructions to the jury. This was improper, and the district court should have refused to allow such testimony despite the agreement of the parties.”).

Aside from the actual constructions adopted by the court, which are incorporated into jury instructions, the *Markman* opinion should not be shown to the jury. The *Markman* ruling ordinarily includes language that rejects the claim-construction positions of one of the parties and thus conveying that information to the jury would be prejudicial to the party whose position was rejected. Giving the *Markman* ruling to the jury might also interfere with its analysis of the infringement and invalidity arguments, particularly when (as is common) the *Markman* ruling contains a discussion of the accused device and the prior art.

Since the court will read its construction of terms to the jury, the parties should be required to propose constructions in their *Markman* briefs in the specific language they want the court to read to the jury.

5.2 Analytic Framework and Substantive Principles

As mentioned at the outset of this chapter, the modern practice of claim construction derives from the seminal case of *Markman v. Westview Instruments*, 517 U.S. 370 (1996). It held that the meaning of patent claims is a matter for the court, not the jury, to decide. Although providing some guidance on the approach for construing patent claims, the *Markman* decision spawned many issues relating to the proper framework for determining claim meaning. The Federal Circuit has issued hundreds of opinions since *Markman* addressing this subject. Its approach has shifted over the years and therefore it is critical for courts to ensure that they focus on the most current and authoritative decisions. The Federal Circuit's en banc decision in *Phillips v. AWH Corp.*, 415 F.3d 1303 (Fed. Cir. 2005), stands as the most authoritative synthesis of claim-construction doctrine. While it put to rest some controversies, many core tensions in claim construction persist. Moreover, the decision does not provide a step-by-step approach to construing claims. Our goal in this section of the guide is to provide a systematic process for approaching the *Markman* determination.

This section begins by explaining the process of claim drafting to understand the genesis and evolution of claim terms. It then previews the sources for determining claim meaning and the general hierarchy set forth in *Phillips*. With this background in place, we then offer a structured analysis of claim construction. At the highest level of abstraction, claim construction entails analysis of several threshold questions regarding whether and when a claim term is interpreted and then working through the construal process. The court begins the process with an initial interpretation of the claim term in question based on its own reading. To the extent that the parties identify additional sources of guidance from the intrinsic evidence or extrinsic

sources, the court must then systematically work through those sources to reach a proper construction. There are several special cases as well: commonly interpreted terms, means-plus-function claim terms, and mistaken or indefinite claim terms. We also explore the appropriate deference to be accorded prior claim-construction rulings. The section concludes by identifying some common claim-construction pitfalls and by summarizing key processes and substantive issues.

5.2.1 Claim Drafting: The Genesis and Evolution of Claim Terms

Patent claim terms emerge through a process that typically involves multiple contributors who employ at least three distinctive vocabularies—plain English, scientific and/or technical jargon, and the conventions of claim drafting. The court is comfortable with the former but may need assistance interpreting terms that derive from the fields of science and claim drafting. Understanding the process of claim term drafting will ease that semantic challenge.

Figure 5.1 illustrates the drafters, lines of communication, and collaboration leading to the ultimate words used in patent claims. The claim-drafting process begins with the invention and inventor(s). Whether independent or employed in a corporate or university research and development unit, the inventor(s) will in most cases communicate their ideas to a trained patent attorney or agent. That person will typically have some familiarity with the field of invention (although not necessarily to the level of the inventor), as well as substantial training in the drafting of patent applications. Their job is to describe and claim the invention in terms that will satisfy the requirements of the Patent Act. They will seek to write the claims with sufficient specificity to clear the validity hurdles while providing the patentee with significant breadth to cover the foreseeable uses of the invention. As indicated by the two-headed arrow between the inventor and the patent prosecutor, there is often substantial dialogue between the inventor and the drafter before filing the initial application. After that initial filing, however, prosecution of the application and continuations may go on for years. There is often minimal or no interaction between the patent attorney and the inventor during this period, which causes nomenclature to drift and can later complicate claim construction. (This can lead to the anomalous and surprisingly common situation, many years later, in which a court can be called upon to construe a claim term that appears nowhere in the specification.) Whereas the inventor may be steeped in the language of his or her field, the patent drafter uses terms from science as well as claim drafting to achieve a delicate balance of clarity, breadth, and flexibility.

Figure 5.1
Crafting of Patent Claim Terms

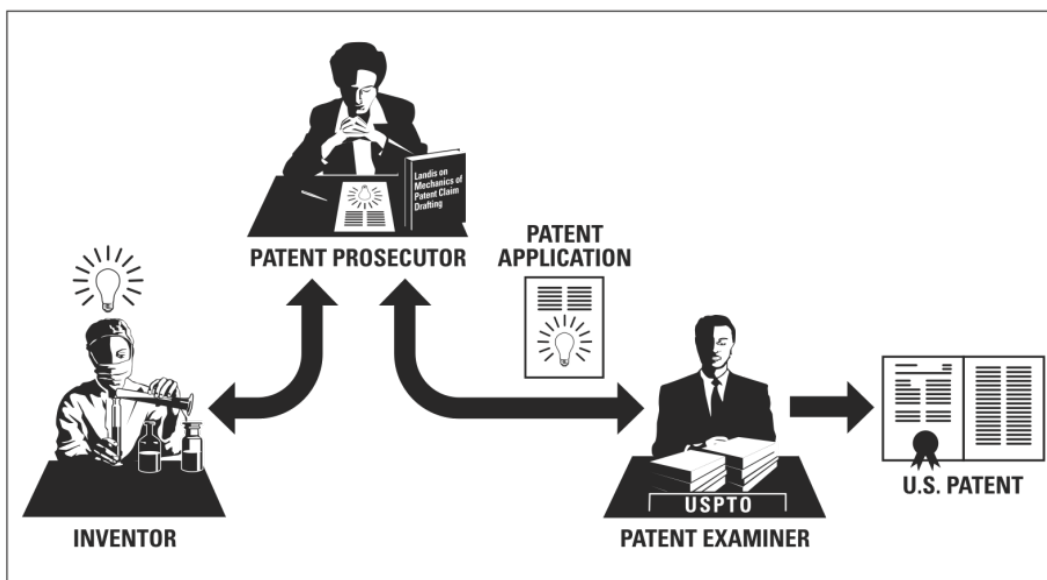

The process of claim drafting does not end when the patent application is submitted. The patent examiner will often play a role in the ultimate claim language of patents. Like the patent prosecutor, examiners have some knowledge of the technical field as well as experience in the process of claim drafting and evaluations. As with the process of application drafting, communication between the prosecutor and the examiner travels in both directions. Patent claims are frequently amended during the prosecution process based on the actions of the examiner. The examiner’s focus is on determining that the claims are valid—(1) not anticipated, obvious, or indefinite; and (2) adequately described.

Thus, patent claim language can be an amalgam of multiple vocabularies and perspectives. Patent case law instructs courts to interpret patent claims from the perspective of a person having ordinary skill in the art (i.e., the scientist, technologist, or artisan in the relevant field of invention). This characterization, however, glosses over the role of the patent draftsman and the examiner in actual claim-drafting practice. Whereas some claim terms—such as “hydroxypropyl, methylcellulose”—undoubtedly derive their meaning from the pertinent technical art, other terms—such as the transitional phrase “comprising”—are better understood from the perspective of the person having ordinary skill in *claim drafting*. Still other terms are simply being used in their plain English sense. Courts need to be sensitive to these distinctions in determining which terms require construction and how to interpret those terms.

5.2.2 Sources for Deriving Claim Meaning

As introduced earlier, *see* § 5.1.3.1, claim construction draws on two general categories of evidence: intrinsic and extrinsic. Chart 5.1 summarizes the main components of these sources.

Chart 5.1
Sources of Evidence for Claim Construction

<p>Intrinsic Evidence</p> <ul style="list-style-type: none">• Patent• Prosecution history• Foreign and related patents (and their prosecution histories)• Prior art that is cited or incorporated by reference in the patent-in-suit and prosecution history <p>Extrinsic Evidence</p> <ul style="list-style-type: none">• Inventor testimony• Expert testimony• Other documentary evidence• Dictionaries• Treatises

Prior to the *Phillips* decision, the Federal Circuit doctrine on whether extrinsic evidence could be considered and what role it should play shifted significantly. From 1996 until 2002, consideration of extrinsic evidence beyond educating the court about the technology was heavily disfavored. *See Vitronics Corp. v. Conceptonics, Inc.*, 90 F.3d 1576, 1583 (Fed. Cir. 1996) (finding it was “improper to rely on extrinsic evidence”). Nearly contemporaneous decisions, however, cautioned against such a strong reading. *See Key Pharm. v. Hercon Labs. Corp.*, 161 F.3d 709, 716 (Fed. Cir. 1998) (noting that *Vitronics* “might be misread by some members of the bar as restricting a trial court’s ability to hear [extrinsic] evidence. We intend no such thing.”). In 2002, the Federal Circuit appeared to elevate dictionaries, a special category of extrinsic evidence, to a central role in claim construction. *See Tex. Dig. Sys., Inc. v. Telegenix, Inc.*, 308 F.3d 1193 (Fed. Cir. 2002). Within a short time, however, the limitations of this approach became apparent:

The main problem with elevating the dictionary to such prominence is that it focuses the inquiry on the abstract meaning of words rather than on the meaning of claim terms within the context of the patent . . . [H]eavy reliance on the dictionary divorced from the intrinsic evidence risks transforming the meaning of the claim term to the artisan into the meaning of the term in the abstract, out of its particular context, which is the specification.

Phillips, 415 F.3d at 1321.

Phillips shifted attention back toward the intrinsic record while recognizing that extrinsic evidence can be considered, although with healthy skepticism. Extrinsic evidence may be considered if the court deems it helpful “to educate [itself] regarding the field of invention . . . [and to] determine what a person of ordinary skill in the art would understand claim terms to mean.” *Id.* at 1319. The court emphasized, however, that extrinsic evidence must be considered “in the context of the intrinsic evidence[,]” but is “less reliable than the patent and its prosecution history in determining how to read claim terms.” *Id.* at 1318–19. The Supreme Court’s ruling in *Teva* underscores that extrinsic evidence may be considered, although it reaffirms the principle that intrinsic evidence is paramount in construing patent claims, and extrinsic evidence may not contradict it.

5.2.2.1 Principal Source: Intrinsic Evidence

“Intrinsic” evidence refers to the patent and its file history, including any reexaminations and reissues. Intrinsic evidence also includes related patents and their prosecution histories. In addition, the Federal Circuit generally treats as intrinsic evidence the prior art that is cited or incorporated by reference in the patent-in-suit and prosecution history.

5.2.2.1.1 Prosecution History

Beyond the specification and other claims, an important source of evidence in claim construction is a patent’s prosecution history. A “prosecution history” consists of “the complete record of the proceedings before the PTO and includes the prior art cited during the examination of the patent.” *Phillips*, 415 F.3d at 1317. During those exchanges, the USPTO will commonly reject the pending patent claims as unpatentable in light of prior art technologies. In response, the patent applicants will typically explain why their claimed inventions are patentable over what had come before. The Federal Circuit cautions that “because the prosecution history represents an ongoing negotiation between the PTO and the applicant, rather than the final product of that negotiation, it often lacks the clarity of the specification and thus is less useful for claim construction purposes.” *Id.*

More specifically, the patentee may expressly limit the scope of its patent through disclaimers to avoid prior art. Courts must carefully evaluate such disclaimers during claim construction.

The communications between the applicant and the USPTO may reveal the “ordinary meaning” of a claim term—that is, the communications may show the meaning of a claim term in the context of the patent. *See id.* (“Like the specification, the prosecution history provides evidence of how the PTO and the inventor understood the patent.”). For example, in *Nystrom v. TREX Co.*, the prosecution history of the patent confirmed that the claim term “board” in the patent referred to wooden boards, and not plastic boards. *See* 424 F.3d 1136, 1145 (Fed. Cir. 2005); *Hynix Semiconductor Inc. v. Rambus Inc.*, 645 F.3d 1335, 1350 (Fed. Cir. 2011) (interpreting the prosecution history to support a broad interpretation of “bus” because the prosecu-

tion history showed that “[a]lthough some of Rambus’s claimed inventions require a multiplexing bus, multiplexing is not a requirement in all of Rambus’s claims”).

5.2.2.1.2 Related and Foreign Applications

Some patents issue from single applications with a single prosecution history. Other patents are members of large families of related patents with a web of underlying patent applications, along with counterparts filed in foreign countries. In the latter instances, when one patent is in suit, parties may find statements in its related patents and patent applications, and in its foreign counterparts, that bear on claim construction. To what extent these statements in related filings impact the construction of the patent in suit is a common dispute in patent litigation.

Where there are a series of patent applications, with the patent in suit issuing from a later filed application, disputes frequently arise over the implications of statements made during prosecution of an earlier filed application (i.e., in a “parent” application). The statements in the parent application are most relevant where the earlier statements address common claim terms with the patent being construed. *Trading Techs. Int’l, Inc. v. Open E Cry, LLC*, 728 F.3d 1309, 1322–23 (Fed. Cir. 2013); *Advanced Cardiovascular Sys., Inc. v. Medtronic, Inc.*, 265 F.3d 1294, 1305–06 (Fed. Cir. 2001). Moreover, where an amendment in a parent application “distinguishes prior art and thereby specifically disclaims a later (though differently worded) limitation in the continuation application,” the prosecution disclaimer may apply. *Invitrogen Corp. v. Clontech Labs., Inc.*, 429 F.3d 1052, 1078 (Fed. Cir. 2005). The earlier disclaimer may continue to apply throughout a patent family, particularly if the applicants do not later inform the PTO that they want to rescind the earlier disclaimer. See *Hakim v. Cannon Avent Grp., PLC*, 479 F.3d 1313, 1318 (Fed. Cir. 2007) (“Although a disclaimer made during prosecution can be rescinded, permitting recapture of the disclaimed scope, the prosecution history must be sufficiently clear to inform the examiner that the previous disclaimer, and the prior art that it was made to avoid, may need to be re-visited.”). However, the general rule is that when different claim terms are present in the parent and descendant applications, the earlier statements have no bearing on claim construction. See *Ventana Med. Sys., Inc. v. Biogenex Labs., Inc.*, 473 F.3d 1173, 1182 (Fed. Cir. 2006) (“[T]he doctrine of prosecution disclaimer generally does not apply when the claim term in the descendant patent uses different language.”); *ResQNet.com, Inc. v. Lansa, Inc.*, 346 F.3d 1374, 1383 (Fed. Cir. 2003) (“Although a parent patent’s prosecution history may inform the claim construction of its descendant, the [parent] patent’s prosecution history is irrelevant to the meaning of this limitation because the two patents do not share the same claim language.”); *Hill-Rom Servs., Inc. v. Stryker Corp.*, 755 F.3d 1367, 1372 (Fed. Cir. 2014) (disregarding statements made in unrelated prosecution history).

Statements to foreign patent offices in counterpart filings may be relevant to construing a U.S. patent where the statements made to the foreign office demonstrate the ordinary meaning of a claim term. See *Starhome GmbH v. AT&T Mobility LLC*, 743 F.3d 849, 858 (Fed. Cir. 2014) (relying on statements to European Patent Office to confirm construction of “intelligent gateway”); *Glaxo Grp. Ltd. v. Ranbaxy Pharm., Inc.*, 262 F.3d 1333, 1337 (Fed. Cir. 2001) (noting that a statement in a relat-

ed U.K. prosecution history “bolsters this reading” of the claimed “essentially free from crystalline material” limitation in the asserted U.S. patent); *see also Tanabe Seiyaku Co., Ltd. v. U.S. Int’l Trade Comm’n*, 109 F.3d 726, 733 (Fed. Cir. 1997) (“In the present case, the representations made to foreign patent offices are relevant to determine whether a person skilled in the art would consider butanone or other ketones to be interchangeable with acetone in Tanabe’s claimed N-alkylation reaction.”). However, because the legal requirements for obtaining a patent in other countries may be unique to those countries, statements made to comply with those requirements are generally disregarded in interpreting a U.S. patent. *See Pfizer, Inc. v. Ranbaxy Labs., Ltd.*, 457 F.3d 1284, 1290 (Fed. Cir. 2006) (“[T]he statements made during prosecution of foreign counterparts to the [patent in suit] are irrelevant to claim construction because they were made in response to patentability requirements unique to Danish and European law.”); *Apple Inc. v. Motorola, Inc.*, 757 F.3d 1286, 1312 (Fed. Cir. 2014) (explaining that the Federal Circuit will consider “statements made before a foreign patent office when construing claims if they are relevant and not related to unique aspects of foreign patent law,” and limiting claim scope based on statements to Japanese patent office).

5.2.2.2 Extrinsic Evidence Is Permissible, but It May Not Contradict or Override Intrinsic Evidence

“Extrinsic evidence” refers to all other types of evidence, including inventor testimony, expert testimony, and documentary evidence of how the patentee and alleged infringer have used the claim terms. Dictionaries are considered to be “extrinsic” evidence. *Phillips*, 415 F.3d at 1318. Judicial decisions from related proceedings may be appropriate extrinsic evidence. *See V-Formation, Inc. v. Benetton Grp. SpA*, 401 F.3d 1307, 1312 (Fed. Cir. 2005) (“The district court properly referred to a related, non-binding judicial opinion to support its independent conclusion in this case.”). *Phillips* reaffirmed that the intrinsic evidence is paramount in construing patent claims. Nonetheless, extrinsic evidence can be useful, and *Phillips* and *Teva* confirm that district courts are free to consider extrinsic evidence, including expert testimony, dictionaries, treatises, and other such sources. Litigants continue to argue that it is improper to consider extrinsic evidence in *Markman* rulings, citing *Vitronics*, 90 F.3d 1576. However, the Federal Circuit long ago disavowed any such interpretation of *Vitronics*, and *Phillips* and *Teva* put to rest any suggestion it is wrong to consider extrinsic evidence.

A key to relying on extrinsic evidence is recognizing its limitations. *Phillips* spells out five reasons why extrinsic evidence is inherently less reliable than intrinsic evidence:

First, extrinsic evidence by definition is not part of the patent and does not have the specification’s virtue of being created at the time of patent prosecution for the purpose of explaining the patent’s scope and meaning. Second, while claims are construed as they would be understood by a hypothetical person of skill in the art, extrinsic publications may not be written by or for skilled artisans and therefore may not reflect the understanding of a skilled artisan in the field of the patent.

Third, extrinsic evidence consisting of expert reports and testimony is generated at the time of and for the purpose of litigation and thus can suffer from bias that is not present in intrinsic evidence. . . . Fourth, there is a virtually unbounded universe of potential extrinsic evidence of some marginal relevance that could be brought to bear on any claim construction question Finally, undue reliance on extrinsic evidence poses the risk that it will be used to change the meaning of claims in derogation of the “indisputable public records consisting of the claims, the specification and the prosecution history,” thereby undermining the public notice function of patents.

Phillips, 415 F.3d at 1318–19. Thus, the court must always probe expert testimony for bias and ensure that any expert who offers an opinion is subject to cross-examination. The chief risk of relying on dictionaries, treatises, and other outside documents is pertinence: there is often a gap between how such outside sources characterize a technology and the way a patent presents and claims it. Nonetheless, extrinsic evidence is an increasingly important source for claim construction. See, e.g., *AIA Eng’g Ltd. v. Magotteaux Int’l*, 657 F.3d 1264, 1273–75 (Fed. Cir. 2011) (confirming construction of “homogeneous ceramic composite” based on expert testimony and scholarly treatises); *In re NTP, Inc.*, 654 F.3d 1279, 1289 (Fed. Cir. 2011) (relying on expert testimony that reaffirmed the definition present in specification to justify claim construction).

The Supreme Court’s *Teva* decision establishes that extrinsic evidence may establish how a skilled artisan would understand the disputed claim term as of the time of invention. Nonetheless, the extrinsic evidence may not contradict the intrinsic evidence in determining the ultimate claim construction. Thus, the district court should pay special attention to the extent to which the intrinsic evidence constrains the interpretation of disputed claim terms.

5.2.2.2.1 Illustrations of Reliance (and Nonreliance) upon Extrinsic Evidence

Where the specification supports two interpretations of a disputed claim, extrinsic evidence can confirm which interpretation is more consistent with what a person having ordinary skill in the art would have understood at the time of invention. *Phillips* and *Teva* removed any doubt that it might be appropriate to base claim construction on extrinsic evidence. Nonetheless, the Federal Circuit remains highly circumscribed about when it is appropriate to use extrinsic evidence as the source of a proper construction. The Federal Circuit characterized the limited role for extrinsic evidence, saying: “[i]f, and only if, the intrinsic evidence does not establish the meaning of a claim, we can turn to the extrinsic evidence, e.g., inventor testimony, expert testimony, and learned treatises.” *Indus. Tech. Research Inst. v. Int’l Trade Comm’n*, 567 F. App’x 914, 917–18 (Fed. Cir. 2014).

The Federal Circuit commonly approves the use of extrinsic evidence to confirm the propriety of a construction that is based in the intrinsic evidence. That is, once the intrinsic evidence has been found to favor a particular construction, it is appropriate to confirm that this construction is consistent with extrinsic evidence.

For example, in *H-W Technology, L.C. v. Overstock.com, Inc.*, 758 F.3d 1329 (Fed. Cir. 2014), the question was whether the claim phrase “user of said phone” was limited to a human, or whether a “thing” could constitute such user. Because the intrinsic evidence indicated that only a human could be such a user, and the extrinsic evidence was mixed, the Federal Circuit agreed that the “user” was limited to a human. *See also Interval Licensing LLC v. AOL, Inc.*, 766 F.3d 1364 (Fed. Cir. 2014) (construing claims based on intrinsic evidence to distinguish “data” from “instructions,” and confirming such distinction by resort to extrinsic evidence).

In a dispute over what “homogeneous ceramic composite” meant, the Federal Circuit relied on an engineering textbook that the losing party’s expert had introduced. The expert conceded in testimony, supporting the other party’s position, that a “composite” could generally be viewed as a multiphase material. *See AIA Eng’g*, 657 F.3d 1264.

In *Conoco Inc. v. Energy & Environmental Int’l*, 460 F.3d 1349, 1362 (Fed. Cir. 2006), the question was whether a “stable” suspension of polymer required sufficient stability to remain suspended when stored for a long period of time, or just stability at the time the suspension was introduced into a pipeline. The court determined from the intrinsic evidence that the appropriate frame of reference was stability at the time the suspension was introduced into the pipeline. The court confirmed its interpretation with the extrinsic evidence, which indicated that all suspensions eventually separate, and found that the appropriate time frame for assessing stability is at the time the suspension is introduced into the pipeline.

Tap Pharmaceutical Products, Inc. v. Owl Pharmaceuticals, L.L.C., 419 F.3d 1346 (Fed. Cir. 2005), also used extrinsic evidence to decide between two plausible interpretations of the specification. *Tap Pharmaceutical* concerned claims to a composition “comprising a copolymer . . . of lactic acid and . . . of glycolic acid.” The question was whether the claims were limited to compositions resulting from a polymerization of lactic acid and glycolic acid, or whether the claims also covered the polymer resulting from cyclic precursors that transformed into lactic acid and glycolic acid during polymerization. The district court properly relied on treatises that recognize that copolymers of lactic acid and glycolic acid can be made either by direct polymerization or by ring opening, and on expert testimony that a person of ordinary skill in the art would use the terms “lactic acid” and “glycolic acid” interchangeably with their cyclic analogs. *Id.* at 1349–50.

Attempts to use extrinsic evidence as the *source* for claim constructions are more problematic. Basing the meaning of claim terms on sources external to the patent raises concerns about the notice function of patents. Thus, when extrinsic evidence is used as the source of claim construction, special care must be taken to ensure that the extrinsic evidence is consistent with the patentee’s own description of the invention. For example, an appropriate use of extrinsic evidence concerned claims to a “scanner,” where the term “scanner” was not defined in the specification, which simply contained one illustrative embodiment having a moving scanner head. *Mass. Inst. of Tech. v. Abacus Software*, 462 F.3d 1344, 1351 (Fed. Cir. 2006). Faced with the question of whether a digital camera qualified as a “scanner,” the court turned to dictionaries and concluded that a scanner required “movement between a scanning

element and an object being scanned.” *Id.* This definition was appropriate because it tracked what the patentee had disclosed in the specification as being a scanner. *Id.*; see also *Boston Sci. Scimed Inc. v. Cordis Corp.*, 554 F.3d 982, 997 (Fed. Cir. 2009) (holding that district court permissibly relied on dictionary definitions of “thrombogenic” to construe “non-thrombogenic” when court’s definition was consistent with specification and prosecution history); *Hill-Rom Servs.*, 755 F.3d at 1374 (construing “datalink” broadly to encompass wireless connections, based on expert testimony, when specification was inconclusive)

In a more tenuous example, the Federal Circuit approved the use of expert testimony to set numeric limits on a claim. The claim concerned a pharmaceutical composition with a ratio of “about 1:5” for two chemical components. *Ortho-McNeil Pharm., Inc. v. Caraco Pharm. Labs., Ltd.*, 476 F.3d 1321, 1326–28 (Fed. Cir. 2007). The court reviewed the intrinsic evidence, including claims directed to other ratios, and experimentation disclosed in the specification directed to a range of ratios. It credited the testimony of an expert who opined that “about 1:5” meant “a ratio up to and including 1:7.1 and a ratio down to and including 1:3.6.” The Federal Circuit credited the expert testimony, which justified this range as appropriate because it was not statistically different from the claimed ratio of 1:5. *Id.*

A construction based primarily on extrinsic evidence is inappropriate if it contradicts the intrinsic record. For example, in *Vederi, LLC v. Google, Inc.*, 744 F.3d 1376 (Fed. Cir. 2014), Google was sued on its approach for capturing images for StreetView, which records images as a progression of spherical shots. The patent at issue required “images depicting views of objects in a geographic area, the views being substantially elevations of the objects in the geographic area.” The district court found the patent was limited to “vertical flat (as opposed to curved or spherical)” depictions of the views, relying largely on extrinsic evidence that defined “elevation” as a vertical plane. The Federal Circuit reversed, finding that the claim term “substantially elevations” accommodated more than planar views, and that the patent’s disclosure of using fish-eye lenses confirmed that a strict vertical view was too limiting.

Similarly in *Biagro Western Sales, Inc. v. Grow More, Inc.*, 423 F.3d 1296 (Fed. Cir. 2005), the expert testimony strayed too far from the patent disclosures and sought to reconceptualize the claims. The patent claimed a fertilizer “wherein said phosphorous-containing acid or salt thereof is present in an amount of about 30 to about 40 weight percent.” *Id.* at 1302. The amount of phosphorus-containing acid actually present in the accused fertilizer product did not meet the levels stated in the claim, but the patentee tried to use expert testimony to argue that the amount of phosphorous-containing acid in the claim limitation should be read to refer to a “chemical equivalent amount,” rather than the amount actually present. In support, the patentee cited fertilizer labeling guidelines and standards and expert declarations, asserting that phosphorus levels in fertilizer are measured by chemically equivalent amounts. This evidence failed to persuade the trial court and the Federal Circuit because Biagro could not tie its measurement approach to the patent’s description of the invention. *Id.* at 1303.

It is important to recognize, however, that the Supreme Court’s *Teva* decision has altered the framework for considering extrinsic evidence. Therefore, prior Federal Circuit decisions on the role of extrinsic evidence may no longer be valid. District courts can build their claim-construction analysis on the teachings in *Teva*. They should press the parties seeking to introduce extrinsic evidence on how such evidence relates to the intrinsic record.

5.2.2.2 Concluding Expert Opinions Should Be Disregarded

Expert opinions should be grounded both in the intrinsic evidence and by support in other independent, reliable sources. Where these criteria are lacking, the expert opinions should not be relied upon. *SkinMedica, Inc. v. Histogen Inc.*, 727 F.3d 1187 (Fed. Cir. 2013) (quoting *Phillips*, 415 F.3d at 1317) (disregarding expert opinions, explaining that “conclusory, unsupported assertions by experts as to the definition of a claim term are not useful to a court”). Likewise, in *Network Commerce, Inc. v. Microsoft Corp.*, 422 F.3d 1353, 1361 (Fed. Cir. 2005), a patentee sought a construction based upon its expert declaration that a claimed “download component” need not contain a boot program. The expert declaration failed to explain why the passages quoted from the specification supported his opinion and failed to support the expert’s conclusion with any reference to industry publications or other independent sources. Accordingly, the declaration was properly disregarded. *Id.*

5.2.3 Claim Construction: Two Stages of Analysis

With that background in place, we are ready to map out the overarching structure of claim construction. Chart 5.2 presents the two distinct steps. Litigants sometimes skip over the first inquiry—whether (and when) claim construction is necessary—and jump right into the complexities of claim construction. Many courts—through patent local rules, *see, e.g.*, N.D. Cal. Patent Local Rules, or case management—focus attention on the threshold issues. Before the court confronts the challenge of construing a claim term, it must consider a series of threshold doctrines and principles that determine whether and when a claim term should be construed.

Chart 5.2
Claim Construction Flowchart

Step 1: Is construction of a claim term required?
Step 2: Interpretation of a claim term

5.2.3.1 Step 1: Is Construction of a Claim Required?

Chart 5.3 presents the series of threshold issues that the court should consider in determining whether and when interpretation of a claim term is appropriate.

Chart 5.3
Step 1: Is Construction of a Claim Term Required?

<p>1. Disputed Meaning That Can Be Derived from the Patent/PHOSITA (“person having ordinary skill in the art”)</p> <p>a. Disputed Meaning: Is the meaning of the claim term the subject of legitimate disagreement? <i>See</i> § 5.1.4.3.</p> <p>b. Meaning Derivable from the Patent/PHOSITA: For nontechnical terms, is there a special meaning that can be ascertained from the patent? <i>See</i> § 5.1.4.3.</p>
<p>2. Priority/Discretion/Timing: Courts have broad discretion to limit and phase claim construction.</p> <p>a. Some courts limit first and usually final <i>Markman</i> proceedings to ten terms.</p> <p>b. Court can revisit claim construction; it must eventually construe all legitimately disputed and construable terms before trial.</p> <p>c. Means + function claims (in dispute) must be interpreted to identify corresponding structure, material, or acts. <i>See</i> § 5.2.3.5.</p>
<p>3. Issue Preclusion: Deference to Prior <i>Markman</i> Ruling</p> <p>a. Issue preclusion cannot be applied offensively against a party who was not represented in prior proceeding, but it can be applied defensively if the four-part test is satisfied. <i>See</i> § 5.3.</p> <p style="padding-left: 20px;">i. Judicial estoppel can be applied where patentee changes positions.</p> <p style="padding-left: 20px;">ii. Reasoned deference under stare decisis principles. <i>See</i> § 5.3.4.</p>
<p>4. Is the Term Amenable to Construction? <i>See</i> Table 5.2, § 5.2.3.1.5.</p>

5.2.3.1.1 Is There a Genuine Dispute About the Claim Term?

There is no need to construe terms for the sake of construction. As detailed above, it is recommended that the court order a structured meet-and-confer process to narrow the number of claim terms requiring the court’s resolution. Holding a brief telephone conference, prior to claim-construction briefing, at which the parties must articulate the basis for the dispute often further narrows the number of terms.

The mere existence of a dispute on infringement or validity does not mean that claim construction is necessary. Rather, claim construction is necessary to give meaning to claim terms, not to resolve the underlying questions of liability. *See Am. Piledriving Equip.*, 637 F.3d 1324 (“It is well settled that the role of a district court in construing claims is not to redefine claim recitations or to read limitations into the claims to obviate factual questions of infringement and validity but rather to give meaning to the limitations actually contained in the claims, informed by the written description, the prosecution history if in evidence, and any relevant extrinsic evidence.”).

5.2.3.1.2 Would Claim Construction Help the Jury?

The point of claim construction is to instruct the jury on what the claim means from the perspective of a person having ordinary skill in the art. For many claim terms, attempting to “construe” the claim language adds little in the way of clarity. Where the perspective of a person having ordinary skill in the art would add nothing to the analysis, there may be no need to construe the terms. Nontechnical terms (e.g., “on” or “above” or “surround”) and terms of degree (e.g., “approximately” or “about” or “substantially”) may not require construal by the court. Where “construing” a claim term would involve simply substituting a synonym for the claim term, it may be appropriate to allow the claim language to speak for itself.

Construction of a term is clearly appropriate in the case of disputed technical terms, where a person having ordinary skill in the art would bring a distinctive perspective. Of course, in all cases, where the intrinsic and applicable extrinsic evidence further define a term (such as disclaimers, descriptions of “the present invention,” and claim differentiation), the court should account for such added evidence in the claim construction. Where the intrinsic evidence and extrinsic evidence do not meaningfully add to the definition of a term, however, it is appropriate (and often preferred) to allow straightforward claim language to stand as is.

5.2.3.1.3 Is Claim Construction a Priority?

The initial *Markman* hearing need not construe all disputed claim terms. Courts increasingly focus the initial *Markman* hearing on no more than about ten “priority” terms, with the expectation that resolving the key terms may dispose of the case. See N.D. Cal. Patent Local Rule 4-3(c). Courts are free to revisit any remaining disputes later in the case, but must construe all disputed claim terms before the case is submitted to the jury. How courts wish to balance the priorities of early decision making versus overall completeness will depend on the circumstances of the case.

5.2.3.1.4 Have the Claims Been Construed Before?

There may have been prior proceedings involving the same patents-in-suit or closely related patents. Where there has been a prior construction, the court needs to learn the context of the prior proceedings to determine the impact of doctrines of issue preclusion, claim preclusion, judicial estoppel, and stare decisis. Although the prior proceedings may not be binding in the present litigation, the court should hear from the parties to determine if there are factors that may have preclusive effect or a basis for according deference to the prior claim construction. These important considerations are discussed in § 5.3.

Similarly, in the increasingly common scenario where the patent-in-suit becomes the subject of patent reexamination proceedings, the district court may wish to stay claim construction until those collateral proceedings are resolved. The considerations are addressed in § 4.6.4.

5.2.3.1.5 Is the Term Amenable to Construction?

As illustrated in Table 5.4, claim terms can be categorized into three potentially overlapping general types: (1) lay terms, (2) terms of degree, and (3) technical terms. As discussed previously, *see* §§ 5.1.3.6, 5.1.4.3, not all terms in a claim require construction by the court. It can be improper to construe terms that do not have special meaning that can be derived from the patent.

Table 5.4
Typology of Claim Terms

Type	Lay Terms	Terms of Degree	Technical Terms
Examples	a, above, below, in, surround, to	approximately, essentially, substantial	hydroxypropyl, methylcellulose, cyclic redundancy, oligonucleotide
Amenability to Claim Construction	Such terms are often understood by fact-finder; to construe arguably trenches upon jury’s domain, but such terms may have conventional/ established meaning in the technical field.	Such terms are often understood by jury; to construe arguably trenches upon jury’s domain. Such terms are inherently contextual. Must be careful not to inappropriately import limitations from specification, but must base interpretation on standard set forth in the specification: if no basis set forth therein, then no basis for construction.	Must be interpreted if meaning is disputed; PHOSITA perspective is essential.
Guide Section	§ 5.2.3.1.5.1	§ 5.2.3.1.5.2	§ 5.2.3.1.5.3

As reflected in Table 5.4, the three types of claim terms are not mutually exclusive, and the question of which category is most appropriate will not always be evident based solely on a reading of the claim. The court will need to examine the intrinsic record to make this assessment. Some plain English terms can have technical meanings in particular fields. For example, the word “inventory” can, depending on the context, be a lay term (“an itemized list of merchandise or supplies” or a “detailed list of all items in stock”). It can also have a more specialized meaning in the field of dry-cleaning process inventions. *See Markman v. Westview Instruments, Inc.*, 52 F.3d 967 (Fed. Cir. 1995) (en banc) (interpreting “inventory” as used in patent claim to mean “articles of clothing” rather than cash or inventory receipts), *aff’d*, 517 U.S. 370 (1996).

Figure 5.2
Landscape of Claim Terms

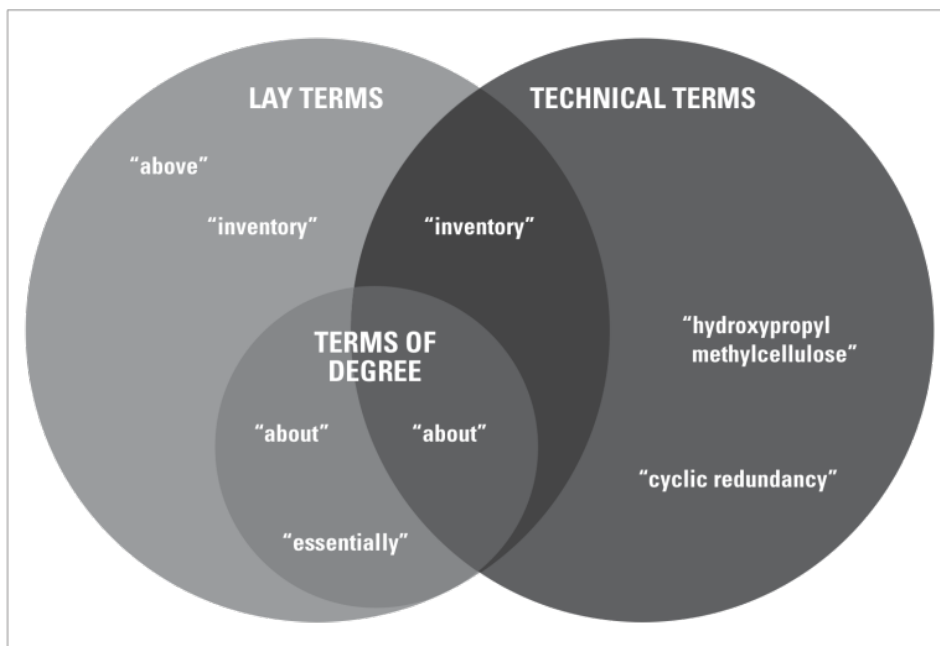

Some technical terms, such as “hydroxypropyl methylcellulose,” may well be self-evident. Terms of degree, however, can be ambiguous. For example, the word “about” can obviously have a nontechnical meaning. When used to describe the scope of a particular invention, however, it may well take on meaning that is delimited by intrinsic, and possibly even extrinsic, evidence. See *Ortho-McNeil Pharm.*, 476 F.3d at 1326–28.

5.2.3.1.5.1 Lay Terms

Patent law has long struggled with how precisely claims should be construed. Many claim terms are inherently imprecise. These include terms of degree, such as “substantially,” “about,” and “approximately,” which we deal with separately because they have been the focus of substantial jurisprudence. District courts are commonly asked to give lay terms additional clarity in claim construction. When imprecise language should be left to the jury remains a subtle, confounding, and thorny aspect of patent adjudication.

Efforts to construe lay terms with precision are in some tension with *Markman*’s division of authority between judges and juries. See *Markman*, 517 U.S. at 384. It is the court’s role to construe the claims, while it is the jury’s role to determine infringement. *Id.* That is, “Step 1” of the infringement analysis is to construe the claims, and “Step 2” is to compare the accused device against the construed claims. Construing terms of degree with more precise language may be error, not only because it “imports limitations” from the specification into the claims, but also because it can impinge on the role of the jury in resolving the question of infringement. The Federal Circuit observed

that “line-drawing” questions over what meets the scope of the claims is appropriately left to the jury in some contexts. See *Acumed LLC v. Stryker Corp.*, 483 F.3d 800, 806 (Fed. Cir. 2007) (“[A] sound claim construction need not always purge every shred of ambiguity. The resolution of some line-drawing problems—especially easy ones like this one—is properly left to the trier of fact.”).

On the other hand, the Federal Circuit decision in *O2 Micro International* dictates that although “district courts are not (and should not be) required to construe every limitation present in a patent’s asserted claims,” the court must interpret the scope of any claim term for which the parties have presented a “fundamental dispute.” 521 F.3d at 1362. In that case, the district court had declined to construe the term “only if” on the ground that it has a well-understood meaning that the jury could apply without judicial interpretation. The parties in the case agreed that “only if” had a common meaning, but the parties disputed the scope of the claim based on this phrase and argued that dispute to the jury. The Federal Circuit vacated the jury verdict and permanent injunction and remanded the case for reconsideration. In view of this decision, the prudent course for district courts will be to construe any claim term—including lay words or phrases—for which there is a legitimate dispute, while keeping in mind that a “plain meaning” construction for certain words and phrases may properly resolve the dispute between the parties. Nonetheless, courts should be skeptical of construing lay terms for which neither party can produce intrinsic evidence indicating a specialized meaning.

5.2.3.1.5.2 Terms of Degree

Courts frequently struggle to construe terms of degree, such as “about,” “approximately” and “essentially.” This arises for two principal reasons. First, these terms are inherently vague. Second, while these terms have common meaning, they arguably take on a technical meaning within the context of the patent.

Courts must first consider whether these terms should be construed at all, or whether the use of these terms renders the claim invalid for indefiniteness. See § 14.3.3.4. Where the terms are not indefinite, they may warrant a definition that provides more particular limits if such words are used in a technical sense or derive meaning from the specification. If the words are not used in a technical sense and the specification does not suggest a standard, the court should not construe the words more precisely but rather leave them for the jury to apply in determining infringement in the context of the accused product or method.

5.2.3.1.5.2.1 Terms of Degree: Potential Indefiniteness

Using terms of degree may render a claim invalid for indefiniteness. The definiteness standard requires “clear notice of what is claimed, thereby appris[ing] the public of what is still open to them.” *Nautilus, Inc. v. Biosig Instruments, Inc.*, 134 S. Ct. 2120, 2128 (2014). *Nautilus* tightened the definiteness standard, holding that a patent is invalid for indefiniteness if its claims, read in light of the patent specification and file history, fail to inform with reasonable certainty those skilled in the art about the scope of the invention. *Id.* at 2129. The Supreme Court recognized that the defi-

nitiness standard “must allow for a modicum of uncertainty” to provide incentives for innovation while avoiding an innovation-discouraging “zone of uncertainty.” *Id.* (quoting *United Carbon Co. v. Binney & Smith Co.*, 317 U.S. 228, 236 (1942)). Accordingly, there is no blanket prohibition on terms of degree. See *Interval Licensing LLC v. AOL, Inc.*, 766 F.3d 1364, 1374 (Fed. Cir. 2014).

The Federal Circuit has since reaffirmed its line of cases that terms of degree may be definite where the patent provides enough certainty to one of skill in the art when read in the context of the invention. See *Id.* at 1370 (“[w]e do not understand the Supreme Court to have implied in [*Nautilus*], and we do not hold today, that terms of degree are inherently indefinite. Claim language employing terms of degree has long been found definite where it provided enough certainty to one of skill in the art when read in the context of the invention.”); *Biosig Instruments, Inc. v. Nautilus, Inc.*, 783 F.3d 1374 (Fed. Cir. 2015) (upholding the validity of the patent at issue in *Nautilus* on remand from the Supreme Court).

While recognizing that the Supreme Court’s *Nautilus* ruling has tightened the indefiniteness standard, see *Interval Licensing*, 766 F.3d at 1370–71 (noting that “it is not enough, as some of the language in our prior cases may have suggested, to identify ‘some standard for measuring the scope of the phrase’”), the Federal Circuit does not believe that the new standard “‘render[s] all of the prior Federal Circuit and district court cases inapplicable’ and ‘all that is required is that the patent apprise [ordinary-skilled artisans] of the scope of the invention.’” *Nautilus*, 783 F.3d at 1381. (quoting *Freeny v. Apple Inc.*, 2014 U.S. Dist. LEXIS 120446, 2014 WL 4294505, at *4 (E.D. Tex. Aug. 28, 2014) (Bryson, J., sitting by designation). Now, the “claims, when read in light of the specification and the prosecution history, must provide objective boundaries for those of skill in the art.” *Interval Licensing*, 766 F.3d at 1370–71.

There are, however, degrees of terms of degree. Some pose more immediate definiteness concerns. “When a ‘word of degree’ is used, the court must determine whether the patent provides “some standard for measuring that degree.” *Nautilus*, 783 F.3d at 1378. (quoting *Enzo Biochem, Inc. v. Applera Corp.*, 599 F.3d 1325, 1332 (Fed. Cir. 2010); *Seattle Box Co., Inc. v. Indus. Crating & Packing, Inc.*, 731 F.2d 818, 826 (Fed. Cir. 1984)). “When a claim limitation is defined in ‘purely functional terms,’ a determination of whether the limitation is sufficiently definite is ‘highly dependent on context (e.g., the disclosure in the specification and the knowledge of a person of ordinary skill in the relevant art area).” *Nautilus*, 783 F.3d at 1378 (quoting *Halliburton Energy Servs., Inc. v. M-I LLC*, 514 F.3d 1244, 1255 (Fed. Cir. 2008)).

Highly subjective terms are the most susceptible to being declared invalid. For example, the Federal Circuit found a claim directed to a computer display providing that content be shown “in an unobtrusive manner” invalid for indefiniteness. See *Interval Licensing*, 766 F.3d at 1371. Finding this term “purely subjective,” the Federal Circuit further noted that the specification provided inconsistent and muddled descriptions of how to apply this term. *Id.*; see also *Datamize, LLC v. Plumtree Software, Inc.*, 417 F.3d 1342, 1352 (Fed. Cir. 2005) (invalidating claim directed to “aesthetically pleasing” display as indefinite, because it is bounded only by the “unpredictable vagaries of any one person’s opinion”).

More commonplace terms such as “substantially” and “about” permeate patent claims. Accordingly, a fundamental question is how to apply the stricter standard of *Nautilus* against these garden-variety terms of degree. Since *Nautilus*, the Federal Circuit has twice cited with approval its earlier ruling in *Enzo Biochem*, 599 F.3d at 1334–35, which upheld the term “not interfering substantially” where intrinsic evidence provided multiple examples that would allow a skilled artisan to determine whether a particular chemical bond linkage group would “interfer[e] substantially” with hybridization. Thus, courts should look to the intrinsic record for examples to give meaning to these terms of degree.

Section 5.2.4.2 provides further and more general discussion of the claim indefiniteness doctrine.

5.2.3.1.5.2.2 The Court Should Not Delineate Terms of Degree “Where the Patent Provides No Standard”

When the court construes a term of degree, a key question is whether the intrinsic evidence provides some standard for measuring that degree. *Exxon Research & Eng'g Co. v. United States*, 265 F.3d 1371, 1381 (Fed. Cir. 2001) (“When a word of degree is used the district court must determine whether the patent’s specification provides some standard for measuring that degree.”). Often there may be no such standard, and the Federal Circuit has frequently ruled that it would be error to impose a more exact construction on terms of degree. See *Playtex Prods., Inc. v. Procter & Gamble Co.*, 400 F.3d 901, 907 (Fed. Cir. 2005) (“But the definition of ‘substantially flattened surfaces’ adopted by the district court introduces a numerical tolerance to the flatness of the gripping area surfaces of the claimed applicator[, which] contradicts the recent precedent of this court, interpreting such terms of degree.”) (citing *Cordis Corp. v. Medtronic AVE, Inc.*, 339 F.3d 1352, 1361 (Fed. Cir. 2003) (refusing to impose a precise numeric constraint on the term “substantially uniform thickness”) and *Anchor Wall Sys. v. Rockwood Retaining Walls, Inc.*, 340 F.3d 1298, 1311 (Fed. Cir. 2003) (holding that “the phrase ‘generally parallel’ envisions some amount of deviation from exactly parallel,” and that “words of approximation, such as ‘generally’ and ‘substantially,’ are descriptive terms commonly used in patent claims to avoid a strict numerical boundary to the specified parameter”)). See also *PPG Indus. v. Guardian Indus. Corp.*, 156 F.3d 1351, 1355 (Fed. Cir. 1998) (“Claims are often drafted using terminology that is not as precise or specific as it might be. . . . That does not mean, however, that a court, under the rubric of claim construction, may give a claim whatever additional precision or specificity is necessary to facilitate a comparison between the claim and the accused product.”); *Renishaw PLC v. Marposs Societa’ per Azioni*, 158 F.3d 1243, 1249 (Fed. Cir. 1998) (“Thus, when a claim term is expressed in general descriptive words, we will not ordinarily limit the term to a numerical range that may appear in the written description or in other claims.”); *Acumed*, 483 F.3d at 806 (rejecting argument that the district court’s construction of “curved shank” to exclude “sharp corners or sharp angles” renders the construction insufficiently definite since the court did not specify precisely how “sharp” is too sharp).

5.2.3.1.5.2.3 The Appropriate Standard for Defining or Declining to Define Terms of Degree

A standard for measuring a term of degree may come from the patent specification and the working examples. As noted above, one case concerns construction of the term “about 1:5,” referring to a pharmaceutical composition having a particular ratio of two components. *Ortho-McNeil Pharm.*, 476 F.3d at 1326–28. The Federal Circuit approved its construction as “a ratio up to and including 1:7.1 and a ratio down to and including 1:3.6.” *Id.* at 1328. This construction was derived from the specification, which contained other examples of ratios that were tested and claimed, and from expert testimony, declaring that a range of 1:7.1 and a ratio down to and including 1:3.6 was not statistically different from the stated ratio of 1:5. This case may represent the high-water mark in terms of extrapolating examples from the specification and imposing numerical limits on claim scope, and may suggest a willingness (as discussed above) to credit district court fact-finding based on extrinsic evidence. By contrast, other cases have refused to assign numerical bounds to the scope of the claim term “about.” See *Modine Mfg. Co. v. USITC*, 75 F.3d 1545, 1551 (Fed. Cir. 1996) (“It is usually incorrect to read numerical precision into a claim from which it is absent . . . it is a question of technologic fact whether the accused device meets a reasonable meaning of ‘about’ in the particular circumstances.”), *overruled in part by Fresenius Med. Care Holdings, Inc. v. Baxter Int’l, Inc.*, 2006 U.S. Dist. LEXIS 36788, 2006 WL 1469517 (N.D. Cal. May 24, 2006); see also *Lexion Med., LLC v. Northgate Techs., Inc.*, 641 F.3d 1352, 1357 (Fed. Cir. 2011) (affirming infringement of claim phrase “having a temperature within 2°C of the predetermined temperature” by device whose temperature occasionally fluctuated beyond 2°C from the predetermined temperature, based on statements in specification indicating that such fluctuations are intended to be within scope of invention).

A standard for measuring a term of degree may come from the applicant’s statements distinguishing the prior art. For example, in *Glaxo Grp. Ltd. v. Ranbaxy Pharms., Inc.*, 262 F.3d 1333, 1337 (Fed. Cir. 2001), the Federal Circuit found that the claim phrase “essentially free of crystalline material” could be properly construed as requiring a crystalline content of less than 10%, based in part on the applicant’s descriptions of the prior art. Similarly, in *Biotec Biologische Naturverpackungen GmbH v. Biocorp, Inc.*, 249 F.3d 1341, 1347 (Fed. Cir. 2001), the Federal Circuit approved construing the term “substantially water free” as having a water content below 5% in accordance with statements during prosecution history that distinguished a prior art reference with a water content from 5%–30%.

The construction of a term of degree may also be based on functional properties required by the context of the claim term or other intrinsic evidence. For example, in *Gemtron Corp. v. Saint-Gobain Corp.*, 572 F.3d 1371 (Fed. Cir. 2009), the Federal Circuit considered what was required for an “end edge portion” of a claimed refrigerator shelf to be “relatively resilient” in light of the claim term “relatively resilient end edge portion which temporarily deflects and subsequently rebounds to snap secure.” Relying on the claim language and that the specification only discussed resiliency in the context of assembly of the shelf, the court construed the claim to require

only that the end edge portion be sufficiently resilient to temporarily deflect and subsequently rebound after glass was inserted into the frame.

However, claim terms, including terms of degree in device or apparatus claims, should not be interpreted to depend on the use of that device absent an express use limitation. For example, the Federal Circuit rejected a construction of “real-time” in the term “displaying real-time data” that required “contextually meaningful delay” because, under this construction, the same apparatus might infringe when used in one activity, but not infringe when used in another. The court explained, “[c]onstruing a non-functional term in an apparatus claim in a way that makes direct infringement turn on the use to which an accused apparatus is later put confuses rather than clarifies, frustrates the ability of both the patentee and potential infringers to ascertain the propriety of particular activities, and is inconsistent with the notice function central to the patent system.” *Paragon Solutions, LLC v. Timex Corp.*, 566 F.3d 1075, 1090–91 (Fed. Cir. 2009); *see also Hewlett-Packard Co. v. Bausch & Lomb, Inc.*, 909 F.2d 1464, 1468 (Fed. Cir. 1990) (“[A]pparatus claims cover what a device is, not what a device does.”).

Terms of degree frequently do not warrant a more precise construction, and it is often appropriate to pass imprecise terms to the jury in its role as fact-finder. However, the intrinsic evidence may suggest an appropriate standard for providing a more concrete measure of claim scope. The right approach is the one that recognizes the tension between the goals of clarifying claim scope and of avoiding imposing extra limitations on claim language, and then carefully assesses the objective measures that can give standards for the claim terms.

The parties will often say a term of degree needs no construction because it has its “plain and ordinary” or “ordinary and customary” meaning. Courts must probe such positions, because parties often will have fundamentally different views about the “plain and ordinary” meaning of a term. Alternatively, they may use the “plain and ordinary” label to maintain flexibility in their construction of the term. Failure to explore what a party means by the “plain and ordinary” meaning can result in an unresolved construction issue arising during trial.

5.2.3.1.5.3 Technical Terms

When there are genuine disputes about the scope of technical terms, there is no doubt that construction by the court is required. Nonetheless, some technical terms may have a well-established meaning, in which case the definition might be more akin to a glossary definition or perhaps no construction would be necessary. Furthermore, as reflected in Chart 5.4, some lay terms—such as “about”—might have a technical meaning in the context of the patent and hence will require interpretation by the court. *See O2 Micro*, 521 F.3d at 1362 (failure to construe the term “only if” was error where parties disputed its scope).

5.2.3.2 Step 2: Interpretation of Claim Terms

Once it is determined that a term must be construed and is ripe for construal, the court must delve into the complex jurisprudence of interpreting and applying the

Markman decision. Before discussing the disputes that commonly arise in claim construction, it will be useful to state the principles that are generally *not* in dispute. The *Phillips* en banc decision distills these principles and lays out the basic framework for construing patent claims.

A “bedrock principle” of patent law is that “the claims of a patent define the invention to which the patentee is entitled the right to exclude.” *Phillips*, 415 F.3d at 1312. The “objective baseline” for construing patent claims is determining “how a person of ordinary skill in the art understands a claim term.” *Id.* at 1313. “That starting point is based on the well-settled understanding that inventors are typically persons skilled in the field of the invention and that patents are addressed to and intended to be read by others of skill in the pertinent art.” *Id.* Often, other evidence will provide context for characterizing the person having ordinary skill in the art. *See generally* § 14.3.5.3.1 (discussing the standards for determining the characteristics and knowledge of a “person having ordinary skill in the art” (often abbreviated to “PHOSITA”). Temporally, the “ordinary meaning” of a claim term is the meaning that the term would have to a person of ordinary skill in the art “at the time of the invention, i.e., as of the effective filing date of the patent application.” *Phillips*, 415 F.3d at 1313. The “effective filing date” is the earlier of the actual filing date or the filing date of an application from which priority is accorded. *See* § 14.3.3.2 n.19. This is significant and can generate evidentiary challenges, because the meaning of scientific and technical terms can change significantly during a patent’s lifespan. In the field of digital technology, for example, change can occur rapidly given the exponential rate of advance in computer technology. Litigation over patent claims can occur multiple technological generations after the patent claim term was drafted.

The court’s task is to interpret claims through the eyes of a person having ordinary skill in the art field of the invention. That person “is deemed to read the words used in the patent documents with an understanding of their meaning in the field, and to have knowledge of any special meaning and usage in the field.” *Phillips*, 415 F.3d at 1313 (quoting *Multiform Desiccants, Inc. v. Medzam, Ltd.*, 133 F.3d 1473, 1477 (Fed. Cir. 1998)). Interpreting patent claims thus requires the court to consider “the same resources as would that person, viz., the patent specification and the prosecution history.” *Id.* The proper definition of a claim term is context-dependent. The patent and its prosecution history “usually provide[] the technological and temporal context to enable the court to ascertain the meaning of the claim to a person having ordinary skill in the art at the time of the invention.” *Id.* (quoting *V-Formation*, 401 F.3d at 1310). Thus, patent claims are to be interpreted in light of this “intrinsic” evidence (i.e., the patent specification and its prosecution history) as well as pertinent “extrinsic” evidence (i.e., evidence showing the usage of the terms in the field of art).

5.2.3.2.1 Claim-Construction Framework

Figure 5.3 illustrates the starting and ending points for claim construction. We might analogize the claim-construction process to a train line. The first station is the claim itself. “Importantly, the person of ordinary skill in the art is deemed to read the claim term not only in the context of the particular claim in which the disputed term appears, but in the context of the entire patent, including the specification.” *See Phil-*

lips, 415 F.3d at 1313. “In some cases, the ordinary meaning of claim language as understood by a person of skill in the art may be readily apparent even to lay judges, and claim construction in such cases involves little more than the application of the widely accepted meaning of commonly understood words In such circumstances, general purpose dictionaries may be helpful.” *Id.* at 1314 (citation omitted).⁴ If the term is technical, the court may ascribe little, if any, meaning to the term without substantial background education. Furthermore, “because patentees frequently use terms idiosyncratically, the court looks to ‘those sources available to the public that show what a person of skill in the art would have understood disputed claim language to mean.’” *Id.* (citation omitted).

Figure 5.3
Claim-Construction Process: Starting Point and Destination

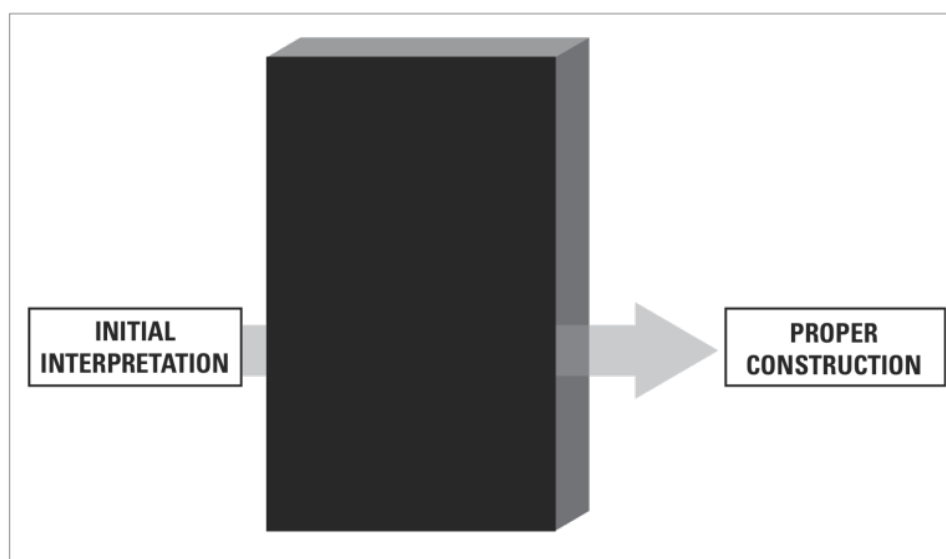

The ultimate destination for this process is the proper construction. This will depend on the appropriate legal standard (the meaning that a person having ordinary skill in the art would attach), the relevant time period (the time of the invention), and the pertinent intrinsic and extrinsic evidence. It may also depend on the jurisprudence of claim construction, such as the doctrine of claim differentiation. A court will develop the proper construction based on a searching review of the intrinsic evidence and any other evidence that the parties present. There are multiple potential “stops” along this track.

Figure 5. illustrates the principal potential stops along the claim-construction line. The parties must inform the court which stations are relevant to interpreting

4. Later in the *Phillips* decision, the Federal Circuit highlighted several pitfalls of relying on dictionaries for claim construction, most notably the tendency toward abstract meaning as opposed to the meaning of claim terms in the context of the patent. See *Phillips*, 415 F.3d at 1319–24; see also § 5.4.

the claim and what specific evidence bears on the proposed interpretation. If no evidence is adduced or if the evidence cited is unilluminating, then the court’s initial interpretation becomes the proper construction (or the court might deem the claim term as it is). More commonly, the parties will call attention to various sources of meaning from the specification, file wrapper, or extrinsic sources. We explore the jurisprudence relating to this process in what follows.

Figure 5.4
Claim-Construction Process: Inside the Black Box

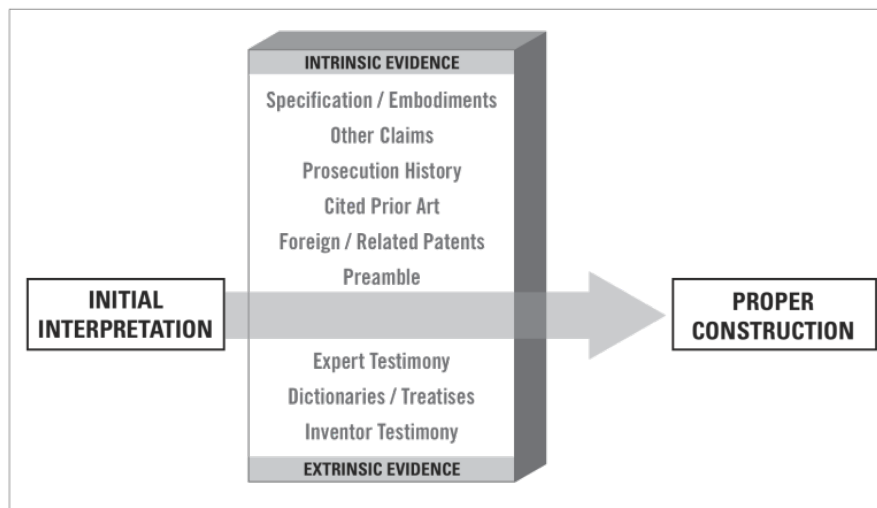

Note that the stations along the claim-construction railroad are aligned vertically but not horizontally. The vertical alignment reflects the priority to be accorded intrinsic evidence. The Federal Circuit has often noted, and the *Phillips* decision affirms, that the specification is the “primary basis for construing the claim” and is in most cases “the best source for understanding a technical term.” See *Phillips*, 415 F.3d at 1314 (citations omitted). The sources are not organized horizontally because *Phillips* set forth the principle that “there is no magic formula or catechism for conducting claim construction. Nor is the court barred from considering any particular sources or required to analyze sources in any specific sequence, as long as those sources are not used to contradict claim meaning that is unambiguous in light of the intrinsic evidence.” *Id.* at 1324.

Figure 5. frames the substantive analysis. The principles set forth at the top of the chart ground the inquiry. Since the court must construe the term as it would have been understood by a skilled artisan as of the time that the invention was made, a tutorial can be especially useful. An evidentiary hearing or expert declarations might be necessary where the parties dispute the skilled artisan perspective as of the time the invention was made (and within the context of the patent).

With this foundation in place, the court should focus on the claim term in question. As the chart’s structure reflects, the inquiry centers on “ordinary meaning.” But it is not necessarily the ultimate destination. The proper construction depends on

how the patent uses the term. Various doctrines pull toward a narrower or broader construction. Where the intrinsic evidence does not resolve the dispute over claim meaning, the court can look to extrinsic evidence. The subsections that follow examine those forces.

Figure 5.5
Functional Landscape of Claim-Construction Principles and Doctrines



5.2.3.2.2 Starting Point for Analysis: “Ordinary Meaning”

The *Phillips* framework uses “ordinary and customary meaning” as the objective baseline for claim construction. *Phillips*, 415 F.3d at 1312–13. It is important to recognize, however, that even the term “ordinary and customary meaning” has a specialized meaning in patent law. It does not denote the ordinary meaning that a lay-

person would ascribe to the claim term. Nor does it signify abstract meaning or meaning in a vacuum. Rather, the “ordinary meaning” under *Phillips* is meaning that a person having ordinary skill in the art would attribute to the claim term in the context of the entire patent, including the specification and prosecution history. *Id.* at 1313. *Phillips* recognizes that there may be instances where the specification gives a “special definition” to a claim term that differs from the ordinary and customary meaning of a claim term or that the applicant may have expressly disavowed or disclaimed coverage to the full breadth of the claims under the ordinary and customary meaning. *Id.* at 1316. However, even in those cases where the applicant’s statements in the patent and prosecution history do not rise to the level of a “special definition,” or a “disavowal” or “disclaimer,” *Phillips* recognizes that the proper construction may depart from the ordinary and customary meaning of a claim term.

Phillips reaffirmed that the “starting point” of the analysis is the “ordinary meaning” of the disputed claim terms. However, it overruled prior doctrine on how to determine this ordinary meaning and on the extent to which the ordinary meaning ultimately governs the construction of patent terms. Nonetheless, litigants commonly, and wrongly, attempt to rely on pre-*Phillips* cases that use a now-rejected approach. Because this shift in the law rendered certain lines of authority obsolete, it is important to recognize what *Phillips* changed and which statements from previous case law are no longer valid.

5.2.3.2.2.1 “Presumption of Dictionary Definition” Obsolete

Prior to *Phillips*, a widely applied line of Federal Circuit authority instructed district courts to emphasize dictionary definitions as the source of ordinary meaning. *Tex. Dig. Sys., Inc. v. Telegenix, Inc.*, 308 F.3d 1193, 1204 (Fed. Cir. 2002) (establishing a “presumption in favor of a dictionary definition”). *Texas Digital* instructed district courts to determine the ordinary meaning of claim terms through reference to dictionaries and other sources *before* interpreting the specification. *Id.* *Texas Digital* established a “heavy presumption” that this dictionary-derived ordinary meaning applied. *Id.* at 1202. Overcoming this presumption required showing that the patentee “has clearly set forth an explicit definition of the term different from its ordinary meaning,” or that “the inventor has disavowed or disclaimed scope of coverage, by using words or expressions of manifest exclusion or restriction, representing a clear disavowal of claim scope.” *Id.* at 1204. *Phillips* specifically criticized *Texas Digital*’s reliance on dictionaries, which improperly “focuses the inquiry on the abstract meaning of words rather than on the meaning of claim terms within the context of the patent.” *Phillips*, 415 F.3d at 1321.

5.2.3.2.2.2 “Heavy Presumption” of Ordinary Meaning

Prior to *Phillips*, the Federal Circuit routinely stated that there is a “heavy presumption” that the ordinary meaning of a patent term governs. *See, e.g., Superguide Corp. v. DirecTV Enters., Inc.*, 358 F.3d 870, 874–75 (Fed. Cir. 2004). When the Federal Circuit articulated its claim-construction methodology in *Phillips*, this “heavy

presumption” was omitted. In the years immediately following *Phillips*, this “heavy presumption” language all but disappeared. *But see Elbex Video, Ltd. v. Sensormatic Elecs. Corp.*, 508 F.3d 1366, 1371 (Fed. Cir. 2007). Moreover, the *Phillips* decision expressly rejected the rule of *Texas Digital*, which established a “presumption in favor of a dictionary definition.” *Texas Digital*, 308 F.3d at 1204. According to *Phillips*, a reliance on dictionaries in the first instance improperly “focuses the inquiry on the abstract meaning of words rather than on the meaning of claim terms within the context of the patent.” *Phillips*, 415 F.3d at 1321. Thus, it appeared that *Phillips* rendered the “heavy presumption” of ordinary meaning obsolete.

Phillips overturned the *Texas Digital* methodology by providing that the meaning of claim terms derives, foremost, from the patent documents themselves. Under *Phillips*, it is the intrinsic record that provides the “technological and temporal context” to determine the meaning of claim terms. *Phillips* refocused the analysis on the invention described in the specification: “The claims are directed to the invention that is described in the specification; they do not have meaning removed from the context from which they arose.” *Id.* at 1316 (quoting *Netword, LLC v. Centraal Corp.*, 242 F.3d 1347, 1352 (Fed. Cir. 2001)). Although lawyers commonly cite to language from *Texas Digital*–era case law, those standards are obsolete.

In more recent years, the Federal Circuit has continued to wrestle with this question and appears to be trending back toward a rule that the ordinary meaning will control absent an explicit definition or disavowal. *See Thorner v. Sony Comput. Entm’t Am. LLC*, 669 F.3d 1362, 1365 (Fed. Cir. 2012) (holding ordinary meaning should apply unless there is an explicit definition or disavowal). Steadily, the Federal Circuit has now been reintroducing the “heavy presumption” language back into its cases. *See, e.g., Plantronics, Inc. v. Aliph, Inc.*, 724 F.3d 1343, 1350 (Fed. Cir. 2013); *Starhome*, 743 F.3d at 857. Thus, whether such a “heavy presumption” applies remains an open question. The soundest approach is to rely on *Phillips*, which omits such language.

Certain terms, such as technical terms, will tend to derive their meaning from the applicable field of technology, and accordingly their “ordinary meaning” in the field will normally determine the proper claim construction. As a general rule, the more established a claim term is in the relevant technical field, the harder it will be to justify departing from that meaning, absent compelling lexicography or disavowal in the specification or file history. However, other terms, and particularly the more malleable terms that patent attorneys craft, will derive their meaning from the context of the patent document itself.

5.2.3.2.3 Interpreting Claim Language in Light of the Specification

A fundamental challenge in patent law is how to construe claims “in view of the specification.” *Phillips*, 415 F.3d at 1315. Tension arises from the competing principles that provide, on the one hand, that “the claims made in the patent are the sole measure of the grant.” *Phillips*, 415 F.3d at 1312 (quoting *Aro Mfg. Co. v. Convertible Top Replacement Co.*, 365 U.S. 336, 339 (1961)), and, on the other hand, that a claim term “can be defined only in a way that comports with the instrument as a whole.”

Id. at 1316 (quoting *Markman*, 517 U.S. at 389). When and to what extent the terse wording of patent claims should be interpreted in light of the inventor’s other statements in the specification gives rise to a common tension in patent litigation. Indeed, *Phillips* arose out of precisely this type of dispute.

Since *Phillips*, the Federal Circuit has continued to acknowledge the “tightrope” that district courts must walk when construing claims in light of the specification. See *Andersen Corp. v. Fiber Composites, LLC*, 474 F.3d 1361, 1373 (Fed. Cir. 2007). This tightrope was on full display in *Retractable Technologies, Inc. v. Becton, Dickinson & Co.*, 653 F.3d 1296 (Fed. Cir. 2011). There, the majority opinion, authored by Judge Lourie, concluded that the “body” of a syringe was properly construed as limited to a one-piece structure, to the exclusion of two-piece bodies. In the panel dissent, written by Judge Plager, and then in an opinion dissenting from the denial of rehearing en banc (by Judges Moore and Rader), the judges did not believe that the claimed syringe “body” should be limited to a one-piece structure. *Id.*; see also *Retractable Techs. Inc. v. Becton, Dickinson & Co.*, 659 F.3d 1369 (Fed. Cir. 2011) (Moore & Rader, JJ., dissenting). In many ways, the *Retractable Technologies* case paralleled the dispute in *Phillips*, although this time with the limitation from the specification (i.e., “one-piece”) read into the claims. In *Phillips*, the specification’s description of the “baffles” at issue was not imposed on the claims. See *id.* at 1371 (“With all due respect to the majority in *Retractable Technologies*, the case is inconsistent with *Phillips*, and we are bound to follow our en banc decision.”).

Reconciling the various lines of claim-construction cases is a challenge, and close calls, such as in *Retractable Technologies*, persist. Nonetheless, important guidelines have emerged to govern how to interpret claims in view of the specification. There are several common sources of meaning for claim construction: the preferred embodiments; the manner in which the patentee distinguishes the prior art; the usage of the claim term elsewhere in the patent document (including other claims); disclaimers within the prosecution history; and the preamble. Furthermore, as subsequent sections explore, some commonly used claim terms have become clearer through patent drafting convention and judicial decisions.

5.2.3.2.3.1 The Role of Preferred Embodiments in Claim Construction

Patent specifications typically describe the claimed invention through the use of illustrations or example. In the jargon of patent law, they are characterized as “preferred embodiments.” Often the specification will recite a few or even many preferred embodiments of an invention. Claim-construction disputes often center on the import of such illustrations: (1) Must each claim encompass the preferred embodiments? (2) Are the claims limited to the preferred embodiments? (3) Does the number or range of embodiments affect the breadth of the claims? (4) Does ambiguity in a claim term limit its scope to the preferred embodiments? (5) Do characterizations of embodiments as “the invention” or “the present invention” limit the patent accordingly?

5.2.3.2.3.1.1 Claim Scope Generally Includes Preferred Embodiments

The patent claims should generally be construed to encompass the preferred embodiments described in the specification, and it is generally error to adopt a construction that excludes them. See *On-Line Techs., Inc. v. Bodenseewerk Perkin-Elmer GmbH*, 386 F.3d 1133, 1138 (Fed. Cir. 2004) (“[A] claim interpretation that excludes a preferred embodiment from the scope of the claim is rarely, if ever, correct.”); *MBO Labs., Inc. v. Becton, Dickinson & Co.*, 474 F.3d 1323, 1333 (Fed. Cir. 2007). Important exceptions to this oft-cited rule apply—such as where there is a clear and unambiguous disclaimer of claim scope in the specification or prosecution history, see *Oatey Co. v. IPS Corp.*, 514 F.3d 1271, 1277 (Fed. Cir. 2008); *N. Am. Container, Inc. v. Plastipak Packaging, Inc.*, 415 F.3d 1335, 1345–46 (Fed. Cir. 2005); *SciMed Life Sys., Inc. v. Advanced Cardiovascular Sys., Inc.*, 242 F.3d 1337, 1344 (Fed. Cir. 2001); see also § 5.2.3.2.3, an embodiment is directed to only a subset of claims, see *Helmsderfer v. Bobrick Washroom Equip., Inc.*, 527 F.3d 1379 (Fed. Cir. 2008), or the ordinary meaning simply cannot be stretched to encompass the embodiment. See also § 5.2.3.2.3.4 (concerning disclaimers).

There are two primary scenarios in which a claim can properly be construed in a way that excludes an embodiment: (1) where a change occurs in the file history—i.e., the specification remains static during prosecution but the applicant clearly and unambiguously disclaims some claim scope that he or she originally sought during prosecution; and (2) where the specification contains and claims multiple embodiments, a particular claim may not cover a particular embodiment because other claims do. For example, if the claims are sufficiently clear in the usage of claim terms, the construction should follow that usage even if it excludes embodiments within the specification, especially where other claims would encompass those described embodiments. See *Pacing Techs., LLC v. Garmin Int’l, Inc.*, 778 F.3d 1021, 1026 (Fed. Cir. 2015) (approving construction that excludes embodiment where multiple embodiments are disclosed and claim language does not cover that embodiment); *Uship Intellectual Props., LLC v. United States*, 714 F.3d 1311, 1316 (Fed. Cir. 2013) (finding claim scope to automated systems, notwithstanding disclosure of embodiments of manual systems, in view of prosecution disclaimer); *August Tech. Corp. v. Camtek, Ltd.*, 655 F.3d 1278 (Fed. Cir. 2011) (construing “wafer” to mean a physically discrete wafer in view of term usage within claim and in related claims, despite embodiments in specification suggesting that a “wafer” may be each separate circuit on overall wafer).

5.2.3.2.3.1.2 Is the Patent Limited to the Preferred Embodiments?

A common dispute is whether the claim scope should be limited to the embodiments. The mere fact of a particular embodiment being taught (or even “preferred”) is generally not sufficient to justify limiting an otherwise broad claim scope to the particular embodiment taught. See, e.g., *GE Lighting Solutions, LLC v. AgriLight, Inc.*, 750 F.3d 1304, 1310 (Fed. Cir. 2014) (reversing claim construction which limited

scope of “ICD connector” to features of preferred embodiment); *Azure Networks, LLC v. CSR PLC*, 771 F.3d 1336, 1348 (Fed. Cir. 2014) (reversing claim construction that limited scope of “MAC address” to local address generated by a hub, as taught by embodiments); *Williamson v. Citrix Online, LLC*, 2015 U.S. App. LEXIS 10082, 2015 WL 3687459 at *4 (Fed. Cir. 2015) (reversing construction limited to the disclosed “pictorial map” in view of broader claim language and the lack of disclaimer); *Laryngeal Mask Co. Ltd. v. Ambu S/A*, 618 F.3d 1367, 1371 (Fed. Cir. 2010) (addressing “a difficult case of claim construction,” finding that the term “backplate” is not limited to requiring a tube joint described in the specification; court was “mindful that the specification is the single best guide to the meaning of a disputed term” and that the “specification is replete with discussion of a tube joint,” but concluded that the term “backplate” was not so limited because only the preferred embodiment indicated that the tube joint “is part of the backplate”); *Agfa Corp. v. Creo Prods., Inc.*, 451 F.3d 1366, 1376–77 (Fed. Cir. 2006) (finding that a claimed “stack” of printing plates was not limited to the particular horizontal stack shown in the specification); *Ormco Corp. v. Align Tech., Inc.*, 463 F.3d 1299, 1306–07 (Fed. Cir. 2006) (finding that a claimed “geometry” of orthodontic teeth was not limited to the geometries of orthodontics shown in the specification); *Acumed*, 483 F.3d at 807 (Fed. Cir. 2007) (finding that a claimed “transverse” hole in a bone nail was not limited to the particular “perpendicular” orientation shown in the specification). The mere fact that the disclosed embodiments of a patented invention have a certain feature does not, by itself, justify limiting the scope of the claims to what is disclosed in the specification. Rather, the fact that the preferred embodiment teaches a certain configuration is just one factor that must be weighed along with other factors such as the clarity of the claim language, the specification’s descriptions of the claimed invention, its statements distinguishing the invention from the prior art, and the consistent and uniform usage of claim terms. Other contributing factors include the applicant’s statements to the USPTO during patent prosecution and the doctrine of claim differentiation.

Depending on the strength of these other factors, the scale may tip so that the claim is limited to the embodiment disclosed in the specification. *See Pacing Techs.*, 778 F.3d at 1024–25 (Fed. Cir. 2015) (limiting the scope of the claim term “repetitive motion pacing system having data storage and playback” to having certain disclosed features, based on the disclosed object of the invention); *Abbott Labs. v. Sandoz*, 566 F.3d 1282, 1288 (Fed. Cir. 2009) (“[T]he claims cannot ‘enlarge what is patented beyond what the inventor has described as the invention.’ Thus th[e] court may reach a narrower construction, limited to the embodiment(s) disclosed in the specification, when the claims themselves, the specification, or the prosecution history clearly indicate that the invention encompasses no more than the confined structure or method.”); *Am. Piledriving Equip.*, 637 F.3d at 1333 (declining to give the term “eccentric weight portion” a functional description, but instead construing it to include structural elements described in the patent specification, owing to consistent reference throughout the specification to this structure as relating to the invention as a whole); *Edwards Lifesciences LLC v. Cook Inc.*, 582 F.3d 1322, 1327–31 (Fed. Cir. 2009) (limiting the claim term “graft” to mean “intraluminal graft” when “the only devices de-

scribed in the specification are intraluminal, supporting an interpretation that is consistent with that description”; the specification used the words “graft” and “intraluminal graft” interchangeably; the specification described “intraluminal graft” as the present invention; and neither claim differentiation nor prosecution history required a different construction).

The *Phillips* court acknowledged that “there is sometimes a fine line between reading a claim in light of the specification, and reading a limitation into the claim from the specification.” 415 F.3d at 1323 (quoting *Comark Commc’ns, Inc. v. Harris Corp.*, 156 F.3d 1182, 1186–87 (Fed. Cir. 1998)). The Federal Circuit suggested that courts could reasonably and predictably discern this line by focusing on how a person of ordinary skill in the art would understand the claim terms. *Id.* The Federal Circuit has specifically rejected the contention that a court interpreting a patent with only one embodiment must limit the claims of that patent to that embodiment, because § 112 requires that the claims themselves define the limits of a patent and because a person of ordinary skill in the art would rarely do so. *Id.* (construing *Gemstar-TV Guide v. Int’l Trade Comm’n*, 383 F.3d 1352, 1366 (Fed. Cir. 2004)).

The patentee’s use of a term within the specification and claims will usually make the distinction between a specification meant to set out specific examples of the invention to disclose how to make and use it, and one in which the claims and embodiments are meant to be strictly coextensive. *Phillips*, 415 F.3d at 1323. District courts should bear in mind, however, that claim drafters routinely avoid providing a clear distinction between embodiments that define the invention and those that merely illustrate it. Through this approach, patentees may get the benefit of a narrow interpretation during prosecution, which might enhance the chances of allowance, while preserving the option of asserting a broad interpretation after the patent issues in enforcement actions. Thus, the “fine line” to which the Federal Circuit refers is often blurred.

5.2.3.2.3.1.3 Does the Number and/or Range of Embodiments Affect the Scope of the Claims?

The Federal Circuit observed in *Phillips* that “although the specification often describes very specific embodiments of the invention, we have repeatedly warned against confining the claims to those embodiments.” 415 F.3d at 1323. The court also “expressly rejected the contention that if a patent describes only a single embodiment, the claims of the patent must be construed as being limited to that embodiment.” *Id.* Nonetheless, the number and/or range of embodiments may have relevance to the scope of claims. Disputes over how broadly to construe claims in light of the specification trace back to the patent drafter. The patent drafter is the “least cost avoider” in terms of creating a document that can be readily understood and relied on by the public and any courts that may have to interpret it. Scant descriptions of the invention may not necessarily be limiting, but it is uniquely in the power of the patentee to avoid close calls of claim interpretation by clear and detailed descriptions of the full scope of the claimed invention. Just as empirical scientists provide multiple data points to gauge the limits or reach of their theories, it might reasonably be

hoped that patentees would likewise express inventions of an empirical nature in a number and range of embodiments if necessary, to convey fully the scope of the claimed invention to the public. Even though a claim is not ordinarily limited to a particular disclosed embodiment, the number and range of embodiments may ultimately affect the scope that can be supported, because those embodiments may inform the court how a person of ordinary skill in the art would understand the claim terms—the issue upon which the court’s focus should ultimately remain. *See Phillips*, 415 F.3d at 1323. Proper claim drafting will reduce the burden of, uncertainty surrounding, and need for claim construction.

It may be somewhat ironic, therefore, that claim construction often affords patents supported by a single embodiment with potentially broader scope (ordinary meaning) than more fully illustrated patents. Without as much to consider, the court in the former case is often left with simply the plain language. The principal countervailing force confronting the patentee—the risk that the claim will fail the written description requirement—does not exert much effect as it is often difficult to prove this basis for invalidity. By contrast, patents that are more fully illustrated may provide a clearer basis for construing, and in some cases circumscribing, the scope of the claims. A more balanced middle ground would be to consider the lack of a significant range of illustrative embodiments to be a factor in construing claims based on an empirical foundation. Just as an empirical theory supported by just a single or few examples will be narrower than one supported by a rich and broad range of observations, so the scope of an empirically based invention supported by a single or narrow range of embodiments should, all other factors the same, be understood more narrowly. Such an approach would have the benefit of providing patent drafters with greater incentive to articulate the boundaries of the claimed invention.

It should be noted, however, that claims based upon a conceptual or theoretical foundation may not require disclosure of multiple embodiments to prove their validity or delineate their scope. In such cases, the operative scientific principle will often support and delineate its scope.

5.2.3.2.3.1.4 Does Ambiguity in a Claim Term Limit Its Scope to Preferred Embodiment(s)?

When the claim language is ambiguous, courts look to the specification to determine a reasonable interpretation. *See Rexnord Corp. v. Laitrop Corp.*, 274 F.3d 1336, 1343 (Fed. Cir. 2001) (“[I]f the term or terms chosen by the patentee so deprive the claim of clarity that there is no means by which the scope of the claim may be ascertained by one of ordinary skill in the art from the language used, a court must look to the specification and file history to define the ambiguous term in the first instance.”) (internal marks omitted). In *Comark Communications*, 156 F.3d at 1187, the Federal Circuit observed that interpreting claim language in light of the specification is proper when a term is “so amorphous that one of skill in the art can only reconcile the claim language with the inventor’s disclosure by recourse to the specification.” At the same time, the court cautioned against reading limitations from the specification into the claims (as opposed to interpreting claim language in light of the specification) and declined to do so in that case. *Id.* Nonetheless, courts

have on occasion limited claim terms to the preferred embodiments where there is no other way of grounding the ambiguous language. See *Chimie v. PPG Indus., Inc.*, 402 F.3d 1371 (Fed. Cir. 2005).

5.2.3.2.3.1.5 Characterizations of “the Invention” or “the Present Invention”

When the patentee uses descriptive terms such as “the invention” or “the present invention” to describe their claims, then those descriptive embodiments may be definitional. Using such terms as “the present invention is” or “the present invention requires” is viewed as a “disavowal” of broader scope that might otherwise apply. See *Hill-Rom Servs.*, 755 F.3d at 1372 (“[W]e have held that disclaimer applies when the patentee makes statements such as ‘the present invention requires . . .’ or ‘the present invention is . . .’ or ‘all embodiments of the present invention are . . .’”). For example, in *Pacing Technologies*, 778 F.3d at 1025, the Federal Circuit found that the specification’s repeated use of language identifying the principal and other “object[s] of the present invention” was a clear and unmistakable surrender of claim scope, which justified limiting the scope of the claim term “repetitive motion pacing system having data storage and playback” to having certain disclosed features. The court noted, however, that “the characterization of a feature as ‘an object’ or ‘another object,’ or even as a ‘principal object,’ will not always rise to the level of disclaimer.” However, “[i]n this case, where the patent includes a long list of different ‘objects of the present invention’ that correspond to features positively recited in one or more claims, it seems unlikely that the inventor intended for each claim to be limited to all of the many objects of the invention.” The court noted that the patent specification went further by

including language that constitutes unmistakable disclaimer when considered in the context of the patent as a whole. Immediately following the enumeration of the different objects of the present invention, the ’843 patent states that “[t]hose [nineteen listed objects] and other objects and features of the present invention are accomplished, as embodied and fully described herein, by a repetitive motion pacing system that includes . . . a data storage and playback device adapted to producing the sensible tempo.” With these words, the patentee does not describe yet another object of the invention—he alerts the reader that the invention accomplishes *all* of its objects and features (the enumerated 19 and all others) . . .

Id.

Likewise, *Honeywell Int’l, Inc. v. ITT Indus., Inc.*, 452 F.3d 1312, 1318 (Fed. Cir. 2006), concerned claims to a “fuel injection system component.” Even though the ordinary and customary meaning of a “fuel injection system component” is not limited to a fuel filter, the Federal Circuit found that the proper construction was narrower than that customary meaning and should be limited to a fuel filter. Beyond the fact that all the disclosed embodiments disclosed only fuel filters, the specification repeatedly described the fuel filter as “this invention” and “the present invention.” Applying *Phillips*, the court found that there was no need to show that the inventor had “disavowed or disclaimed scope of coverage,” as *Texas Digital* had previously set

as the standard. *Id.* Rather, the Federal Circuit noted, given the repeated descriptions in the patent specification of “the invention,” that “[t]he public is entitled to take the patentee at his word and the word was that the invention is a fuel filter.” *Id.*; see also *Trading Tech. Int’l, Inc. v. eSpeed, Inc.*, 595 F.3d 1340, 1353–54 (Fed. Cir. 2010) (noting that it “takes some comfort against this risk from the inventors’ use of the term ‘the present invention’ rather than ‘a preferred embodiment’ or just ‘an embodiment’”); *Edwards Lifesciences*, 582 F.3d at 1327–31 (limiting the claim term “graft” to mean “intraluminal graft” when “the specification frequently describes an ‘intraluminal graft’ as ‘the present invention’ or ‘this invention’”); *Andersen*, 474 F.3d at 1367–68 (limiting claim term “composite composition” to pellets in light of statements in specification that are “not descriptions of particular embodiments, but are characterizations directed to the invention as a whole”); *Microsoft Corp. v. Multi-Tech. Sys., Inc.*, 357 F.3d 1340, 1348 (Fed. Cir. 2004) (finding that statements in common specification serve to limit claim language because they “are not limited to describing a preferred embodiment, but more broadly describe the overall inventions of all three patents”); *Alloc, Inc. v. Int’l Trade Comm’n*, 342 F.3d 1361, 1370 (Fed. Cir. 2003) (“[T]his court looks to whether the specification refers to a limitation only as a part of less than all possible embodiments or whether the specification read as a whole suggests that the very character of the invention requires the limitation be a part of every embodiment.”).

Nonetheless, the Federal Circuit held in *i4i Limited Partnership v. Microsoft Corp.*, 589 F.3d 1246, 1259–60 (Fed. Cir. 2009), that describing the advantages of the “present invention” does not necessarily limit the claim to systems possessing those advantages. The issue in *i4i* was whether “distinct” storage means required independent manipulation of the metacode map and mapped content. The court held it did not. The specification stated that the “present invention provides the *ability* to work solely on metacodes Additionally a new map *can* be created based solely on an existing map without requiring the content.” *Id.* at 1259. According to the court, these statements were “best understood as describing the advantages of separate storage, the real claim limitation,” and, given the permissive language, such as “*ability* to work” and “*can* be created,” did not “clearly disclaim systems lacking these benefits.” *Id.*

The fact that a specification discloses only a single embodiment does not, by itself, compel limiting claim scope to that embodiment. *Phillips*, 415 F.3d at 1323. There must be additional evidence beyond the disclosure of a single embodiment to justify narrowing a construction to that embodiment. *Agfa*, 451 F.3d at 1376–77. However, the fact that only a single embodiment is shown is a factor that, when taken into consideration with the patentee’s description of the invention, may show that the inventor only intended to claim a particular feature as his invention. See *Retractable Techs.*, 653 F.3d at 1304 (holding that the invention is limited to a “single body” syringe based on the patentee’s express recitation “that ‘the invention’ has a body constructed as a single structure, expressly distinguish[es] the invention from the prior art based on this feature, and only disclose[s] embodiment[s] that are expressly limited to having a body that is a single piece.”); *Honeywell Int’l*, 452 F.3d at 1318 (limiting scope of “fuel injection system component” to a “fuel filter” because

“[t]he written description’s detailed discussion of the prior art problem addressed by the patented invention, viz., leakage of non-metal fuel filters in EFI systems, further supports the conclusion that the fuel filter is not a preferred embodiment, but an only embodiment”).

5.2.3.2.3.2 Distinctions over the Prior Art

As with descriptions of “the invention,” the patentee’s manner of distinguishing his invention over the prior art may be definitional. That is, the specification’s emphasis on the importance of a particular feature in solving the problems of the prior art is an important factor in defining the claims. These statements that distinguish the claimed invention from the prior art go to the heart of *Phillips*’s instruction to construe claims consistent with a “full understanding of what the inventors actually invented.” *Phillips*, 415 F.3d at 1316. The Federal Circuit has found “disclaimer” when “the patent repeatedly disparaged an embodiment as ‘antiquated,’ having ‘inherent inadequacies,’ and then detailed the ‘deficiencies [that] make it difficult’ to use.” See *GE Lighting Solutions, Inc.*, 750 F.3d at 1309 (quoting *Chi. Bd. Options Exch., Inc. v. Int’l Sec. Exch., LLC*, 677 F.3d 1361, 1372 (Fed. Cir. 2012)).

For example, in *Inpro II Licensing, S.A.R.L. v. T-Mobile USA, Inc.*, 450 F.3d 1350, 1354–55 (Fed. Cir. 2006), the Federal Circuit affirmed the construction of “host interface” as a “direct parallel bus interface.” Among the dispositive factors in this narrow construction were that the only embodiment disclosed was a direct parallel bus interface and that “the specification emphasizes the importance of a parallel connection in solving the problems of the previously used serial connection.” *Id.* Since under *Phillips*, there was no need to show that the inventor had disclaimed scope of coverage, T-Mobile obtained a narrowing construction by demonstrating “what the inventor has described as the invention.” *Id.* at 1355 (quoting *Netword*, 242 F.3d at 1352); see also *Retractable Techs.*, 653 F.3d at 1305 (limiting scope of syringe “body” to a one-piece body based in part on distinction over prior art syringes composed of multiple pieces).

Statements distinguishing the prior art must be sufficiently clear to warrant a narrowing construction. *Ventana Medical Systems, Inc. v. Biogenex Laboratories, Inc.*, 473 F.3d 1173, 1180–81 (Fed. Cir. 2006) concerned claims to a method of “dispensing” reagents onto a microscope slide. The question was whether “dispensing” was limited to “direct dispensing” (i.e., where the reagent container directly dispenses reagents onto the slide without an intermediary), or whether the claims encompassed the use of an intermediary device to “sip and spit” the reagents from the reagent container onto the slide. The specification contained general criticisms of prior art dispensers, including those using “sip and spit” approaches, as well as those using “direct dispensing” approaches. Because the specification equally criticized both types of prior art dispensers, there was nothing to suggest that the inventor was describing the invention as the use of “direct” instead of “sip and spit” dispensing. Therefore, the Federal Circuit found it was inappropriate to limit the claim scope. *Id.* at 1181 (refusing to narrow claim where challenger “points to only general statements by the inventors indicating that their invention is intended to improve upon prior art staining methods”); *OpenWave Sys., Inc. v. Apple Inc.*, 808 F.3d 509 (Fed.

Cir. 2015) (narrowly construing claim term “mobile device” to exclude communication devices containing a “computer module” based on limiting statements in specification that disparages prior art communication devices containing such “computer modules”).

5.2.3.2.3.3 Consistent Usage of Claim Terms

Another claim-construction principle is that the consistent and uniform usage of a claim term in a certain way in the specification may be definitional, showing the “ordinary meaning” of the claim term in the context of the invention. In such circumstances, otherwise broad language in the claim may be limited by the specification’s description of the invention. Consistent usage of a claim term in the specification can be definitional even without a showing that there is an “express definition” of the term or a “disclaimer,” which the now-overruled *Texas Digital* would have required. For example, the claim term “board” was found to be limited to wooden boards (as opposed to plastic lumber) in light of consistent statements in the specification and prosecution history describing the claimed “boards” as made from wood. *Nystrom*, 424 F.3d at 1145 (“The written description and prosecution history consistently use the term ‘board’ to refer to wood decking materials cut from a log.”); see also *VirnetX, Inc. v. Cisco Sys., Inc.*, 767 F.3d 1308, 1319 (Fed. Cir. 2014) (construing “secure communication link” to require anonymity, based on consistent usage throughout specification).

In *ICU Medical Inc. v. Alaris Medical Systems Inc.*, the Federal Circuit affirmed a construction of “spike” to mean “an elongated structure having a pointed tip for piercing the seal, which tip may be sharp or slightly rounded.” 558 F.3d 1368, 1375–76 (Fed. Cir. 2009). The court supported its construction on the ground that “the specification never suggests that the spike can be anything other than pointed” and explained that “adding the functional language ‘for piercing the seal’ is appropriate because it defines the degree to which the spike must be pointed.” *Id.* at 1376; see also *Hologic, Inc. v. SenoRx*, 639 F.3d 1329 (Fed. Cir. 2011) (majority of divided panel construing “asymmetrically located and arranged within the expandable surface” to require the asymmetry be along the longitudinal axis of the balloon when all of the descriptions of the invention describe that type of asymmetry); *Kinetic Concepts, Inc. v. Blue Sky Med. Grp. Inc.*, 554 F.3d 1010, 1018–19 (Fed. Cir. 2009) (construing “wound” to exclude pus pockets and infections in the mammary glands when “all of the examples described in the specification involve skin wounds”). *But see Am. Piledriving Equip.*, 637 F.3d 1324 (reversing district court for improperly construing “eccentric weight portion” to require that the portion extend from a particular portion of the gear and in a particular direction, on the ground that these limitations were not part of the inventor’s claimed definition of the scope of invention); *Arlington Indus. Inc. v. Bridgeport Fittings*, 632 F.3d 1246 (Fed. Cir. 2011) (declining to construe “spring metal adaptor” to require a split, over dissent which argued that the specification only envisioned adaptors with splits); *Thorner*, 669 F.3d at 1367–68 (refusing to construe “attached to said pad” as limited to either internal or external attachment, because limiting statements in specification were not strong enough to give rise to disavowal); *Falana v. Kent State Univ.*, 669 F.3d 1349, 1354–55 (Fed. Cir.

2012) (finding insufficient force to limiting statements in specification to warrant restricting claims to a compound having a “substantially temperature independent helical twisting power,” even though the specification indicates that the invention was narrower than the claim language implied).

5.2.3.2.3.4 Prosecution Disclaimers

Beyond using the prosecution history to ascertain the ordinary meaning of claim terms, the prosecution history can also be used to determine whether there was a “disclaimer” of claim scope. To convince the USPTO to issue patent claims that have been rejected in light of the prior art, patent applicants frequently have to represent that their patent claims do *not* cover certain technologies. These statements are important limitations on claim scope. *Phillips*, 415 F.3d at 1317 (“The purpose of consulting the prosecution history in construing a claim is to exclude any interpretation that was disclaimed during prosecution.”). The legal standard for finding a prosecution history disclaimer requires “a clear and unmistakable disavowal of scope during prosecution.” *Purdue Pharma L.P. v. Endo Pharm. Inc.*, 438 F.3d 1123, 1136 (Fed. Cir. 2006). For example, in *Uship Intellectual Properties, LLC v. United States*, 714 F.3d 1311, 1316 (Fed. Cir. 2013), the court limited claim scope to automated systems, notwithstanding the specification’s disclosed embodiments of manual systems, based on disclaimer in prosecution history. Likewise, in *Atofina v. Great Lakes Chemical Corp.*, 441 F.3d 991, 997 (Fed. Cir. 2006), the Federal Circuit found a prosecution disclaimer to apply, and construed “chromium catalyst” as a catalyst where the only catalytically active material is chromium without the addition of metal oxides or noninert additives. The decision was based on the applicants’ statements in the prosecution history which distinguished the claimed invention from the prior art’s use of metal oxides and noninert additives, and which emphasized the “criticality of utilizing chromium catalyst alone rather than in combination with other metal components.” *Id.*

By contrast, ambiguous statements in the prosecution history do not warrant a disclaimer, particularly when the applicant’s statements are similarly subject to multiple interpretations. *SanDisk Corp. v. Memorex Prods., Inc.*, 415 F.3d 1278, 1287 (Fed. Cir. 2005) (“There is no ‘clear and unmistakable’ disclaimer if a prosecution argument is subject to more than one reasonable interpretation, one of which is consistent with a proffered meaning of the disputed term.”). For example, in *Golight, Inc. v. Wal-Mart Stores, Inc.*, 355 F.3d 1327, 1332 (Fed. Cir. 2004), a claim to a “rotating” spotlight was not found subject to a disclaimer, where statements in the prosecution history referring to the spotlight rotating “through 360°” were attributable to other claims, not the claim at issue. *See also LG Elecs., Inc. v. Bizcom Elecs., Inc.*, 453 F.3d 1364, 1373–74 (Fed. Cir. 2006) (finding that prosecution history statements that the prior art did not teach accessing data signals “over a system bus” were not sufficiently clear to justify limiting claims to require claimed signals to travel over a system bus), *reversed on other grounds by Quanta v. LG Elecs.*, 128 S. Ct. 2109 (2008); *Martek Biosciences Corp. v. Nutrinova Inc.*, 579 F.3d 1363 (Fed. Cir. 2009) (finding no prosecution history disclaimer when applicant also distinguished prior art on alternative grounds). Even if prosecution history disclaimer does not apply because

there is too much ambiguity, this does not mean that the prosecution history is irrelevant. Rather it can still be used “as support for the construction already discerned from the claim language and confirmed by the written description.” *800 Adept, Inc. v. Murex Sec., Ltd.*, 539 F.3d 1354, 1364–65 (Fed. Cir. 2008).

5.2.3.2.4 Looking to Other Claims: The Doctrine of Claim Differentiation

Patents typically contain multiple claims, with variations among the claims describing the patented invention. The doctrine of claim differentiation provides that “each claim in a patent is presumptively different in scope.” *RF Del., Inc. v. Pac. Keystone Techs., Inc.*, 326 F.3d 1255, 1263 (Fed. Cir. 2003). The doctrine is based on “the common sense notion that different words or phrases used in separate claims are presumed to indicate that the claims have different meanings and scope.” *Andersen*, 474 F.3d at 1369. It also reflects the economic reality that patent fees depend on the number of claims in the patent. Patentees would be disinclined to purchase additional claims if they did not offer a different scope. It is important to recognize, however, that the uncertainties of claim interpretation lead all but the most financially sensitive patent drafters to seek multiple overlapping claims. See generally Mark A. Lemley, *The Limits of Claim Differentiation*, 22 Berkeley Tech. L.J. 1389 (2007). Additional claims do not always cover different subject matter. Claim differentiation gives rise to a rebuttable presumption for claim-construction purposes, especially when comparing the scope of an independent claim in view of its dependent claims: “[T]he presence of a dependent claim that adds a particular limitation gives rise to a presumption that the limitation in question is not present in the independent claim.” *Phillips*, 415 F.3d at 1315.

“Pure” claim differentiation refers to the situation where there is no meaningful difference between an independent claim and its dependent claim, except for the presence of an added limitation in the dependent claim. In that situation, the presumption is especially strong that the independent claim is *not* restricted by the added limitation in the dependent claim. *GE Lighting Solutions*, 750 F.3d at 1310 (reversing district court construction that imposed features of dependent claims onto independent claim); *Acumed*, 483 F.3d at 806 (“That presumption is especially strong when the limitation in dispute is the only meaningful difference between an independent and dependent claim.”). In such situations, construing the independent claim to share that limitation would render the dependent claim “superfluous.” *Andersen*, 474 F.3d at 1369–70 (“To the extent that the absence of such difference in meaning and scope would make a claim superfluous, the doctrine of claim differentiation states the presumption that the difference between claims is significant.”). The doctrine of claim differentiation has less force when there are additional differences between the independent claim and its dependent claim, such that the dependent claim would not be rendered “superfluous” by limiting the independent claim. See, e.g., *SRAM Corp. v. AD-II Eng’g, Inc.*, 465 F.3d 1351, 1358 (Fed. Cir. 2006) (restricting an independent claim to use of “precision index downshifting” even though this term was present in the dependent claim, when additional differences existed between the independent and dependent claim).

In the case of two independent claims, the doctrine of claim differentiation does not apply because patent drafters are free to, and commonly do, claim an invention using multiple linguistic variations in multiple independent claims. *See, e.g., Andersen Corp.*, 474 F.3d at 1370 (declining to apply claim differentiation to separate groups of claims to “pellets,” “linear extrudates,” and “composite compositions” where there were other differences varying the scope of the claims); *Curtiss-Wright Flow Control Corp. v. Velan, Inc.*, 438 F.3d 1374, 1380–81 (Fed. Cir. 2006) (recognizing that “[c]laim drafters can also use different terms to define the exact same subject matter.”); *Hormone Research Found. v. Genentech, Inc.*, 904 F.2d 1558, 1567 n.15 (Fed. Cir. 1990) (“It is not unusual that separate claims may define the invention using different terminology, especially where (as here) independent claims are involved.”).

Even in cases of “pure” claim differentiation where the presumption would apply most strongly, the doctrine can be trumped by other considerations. Claim differentiation “can not broaden claims beyond their correct scope.” *Curtiss-Wright*, 438 F.3d at 1380 (quoting *Fantasy Sports Props. v. Sportsline.com*, 287 F.3d 1108, 1115–16 (Fed. Cir. 2002) (quoting *Kraft Foods, Inc. v. International Trading Co.*, 203 F.3d 1362 (Fed. Cir. 2000)). That is, “the written description and prosecution history overcome any presumption arising from the doctrine of claim differentiation.” *Andersen*, 474 F.3d at 1369–70; *see also Edwards Lifesciences*, 582 F.3d at 1332 (Fed. Cir. 2009) (“[C]laim differentiation is a rule of thumb that does not trump the clear import of the specification.”). For example, where the patent applicant disclaimed subject matter during prosecution to obtain the patent, the patentee cannot attempt to recapture that subject matter through the doctrine of claim differentiation. *See Fantasy Sports Props., Inc. v. Sportsline.com, Inc.*, 287 F.3d 1108, 1115–16 (Fed. Cir. 2002). Likewise, where the limitation in the dependent claim was emphasized during prosecution in order to overcome prior art, it may be appropriate to limit the broader, independent claim to that limitation, thereby trumping the doctrine of claim differentiation. *See ERBE Elektromedizin GmbH v. Canady Tech. LLC*, 629 F.3d 1278, 1286–87 (Fed. Cir. 2010) (limiting “low flow rate” of an independent claim to “less than about 1 liter/minute,” as recited in a dependent claim); *see also ICU Med.*, 558 F.3d at 1376 (affirming rejection of claim differentiation argument when dependent claim was added years after the filing date of the original patent and after the introductions of the allegedly infringing products). Given the wide variety of situations where the doctrine of claim differentiation does not apply, the Federal Circuit has cautioned that “[c]laim differentiation is a guide, not a rigid rule.” *Laitram Corp. v. Rexnord, Inc.*, 939 F.2d 1533, 1538 (Fed. Cir. 1991).

5.2.3.2.4.1 Presumption of Claim Differentiation May Be Rebutted Based on Specification or Prosecution History Estoppel

Limiting statements in the specification or prosecution history can rebut a broad claim-term interpretation, even if the breadth of that term is reinforced by the doctrine of claim differentiation. *See Seachange Int’l, Inc. v. C-COR, Inc.*, 413 F.3d 1361, 1369 (Fed. Cir. 2005) (noting that claim differentiation is “not a hard and fast rule and will be overcome by a contrary construction dictated by the written description

or prosecution history”). For example, in *Regents of the University of California v. DakoCytomation California, Inc.*, 517 F.3d 1364, 1375 (Fed. Cir. 2008), the Federal Circuit approved of a limiting construction on the independent claim term “heterogenous mixture” to exclude repetitive sequences, notwithstanding the presence of dependent claims that do not exclude them. Likewise, in *Retractable Technologies*, 653 F.3d at 1305, the Federal Circuit found the doctrine of claim differentiation to be trumped by statements in the specification that limited a claimed syringe “body” to a one-piece body, especially in view of distinctions made over the prior art.

5.2.3.2.4.2 Presumption of Claim Differentiation Does Not Apply to Means-Plus-Function Claims

As discussed more fully in § 5.2.3.5, means-plus-function claims are limited to the corresponding structures and their equivalents under § 112(f). The statutorily mandated scope of these claims cannot be stretched through resort to claim differentiation. See, e.g., *Cross Med. Prods., Inc. v. Medtronic Sofamor Danek, Inc.*, 424 F.3d 1293, 1304 (Fed. Cir. 2005) (“[A]lthough the doctrine of claim differentiation suggests that claim 5 should be broader than claim 1, any presumption that the claims differ with respect to this feature may be overcome by a contrary construction mandated by the application of § 112[(f)].”); *Laitram*, 939 F.2d at 1538 (holding that the doctrine of claim differentiation yields to an interpretation mandated by § 112(f)).

5.2.3.2.5 Significance of the “Preamble” in Claim Construction

Patent claims commonly have a “preamble” that introduces the claimed invention. Some preambles may be just a few words, while others may be lengthy and detailed. A common dispute is whether the wording of the preamble is a limitation on the scope of the patent. A famously vague standard governs this inquiry: terms in the preamble are limiting when they are “necessary to give life, meaning, and vitality to the claims.” *Kropa v. Robie*, 187 F.2d 150, 861 (CCPA 1951). The following principles are used to apply this standard.

Where the preamble is grammatically essential to the claim, the general rule is that it is limiting. *Catalina Mktg. Int’l, Inc. v. Coolsavings.com, Inc.*, 289 F.3d 801, 808–09 (Fed. Cir. 2002). For example, where other terms in the body of the claim derive “antecedent basis” from the preamble, then the preamble is commonly found to be limiting. *Id.* at 808; see also *Bicon, Inc. v. Strauman Co.*, 441 F.3d 945, 952 (Fed. Cir. 2006); *Pacing Techs.*, 778 F.3d at 1023–24. Likewise, where the preamble is “essential to understand limitations or terms in the claim body,” it is similarly limiting. *Catalina*, 289 F.3d at 808 (citing *Pitney Bowes, Inc. v. Hewlett-Packard Co.*, 182 F.3d 1298, 1306 (Fed. Cir. 1999)).

If a preamble term is a “necessary and defining aspect of the invention,” the preamble is limiting. *On Demand Mach. Corp. v. Ingram Indus., Inc.*, 442 F.3d 1331, 1343 (Fed. Cir. 2006); see also *MBO Labs.*, 474 F.3d at 1330 (interpreting the preamble term “immediately” as limiting, because “[t]he patentee here has clearly indicated via the specification and the prosecution history that the invention provides as an essential feature, immediate needle safety upon removal from the patient.”). This prin-

ciple applies with special force where the language of the preamble was used during prosecution history to distinguish the claimed invention from the prior art. *Catalina*, 289 F.3d at 808; see also *In re Cruciferous Sprout Litig.*, 301 F.3d 1343, 1347–48 (Fed. Cir. 2004) (finding the preamble phrase “rich in glucosinolates” limiting because the patentee relied on the preamble to distinguish the prior art in prosecution).

The countervailing principle is that a preamble is not limiting when the body of the claim “describes a structurally complete invention.” *Catalina*, 289 F.3d at 809; see also *Intertool, Ltd. v. Texar Corp.*, 369 F.3d 1289, 1295 (Fed. Cir. 2004) (finding the preamble nonlimiting where the body of the claim described the invention in “complete and exacting structural detail”). Statements of intended uses of an invention are generally *not* limiting. *Catalina*, 289 F.3d at 809; *Ericsson, Inc. v. D-Link Sys., Inc.*, 773 F.3d 1201, 1219 (Fed. Cir. 2014) (declining to limit based on statement of intended use in preamble). This is because “the patentability of apparatus or composition claims depends on the claimed structure, not on the use or purpose of that structure.” *Id.* Thus, many cases turn on the question of whether a statement in the preamble describing the purpose of an invention describes a “necessary and defining aspect of the invention” (which is limiting), or is simply a “statement of intended use” (which is not limiting). A review of the Federal Circuit’s cases over the past ten years, in cases that litigated the issue of whether to construe the preamble, reveals that the dominant approach in the close cases is to construe the preamble as a limitation.

5.2.3.3 Claim Terms Having Conventional, Presumed, or Established Meanings

Claim terms generally take their meaning from the language of the patent, the prosecution history, and the applicable extrinsic evidence. Some terms, however, have meanings that are derived from conventional usage in claim drafting or prior judicial construction. The case law in this area, however, is notoriously malleable. Take, for example, the term “a” (or “an”). The Federal Circuit “has repeatedly emphasized that an indefinite article ‘a’ or ‘an’ in patent parlance carries the meaning of ‘one or more’ in open-ended claims containing the transitional phrase ‘comprising.’” *Baldwin Graphic Sys., Inc. v. Siebert, Inc.*, 512 F.3d 1338, 1342 (Fed. Cir. 2008). The court commented that this interpretation can “best [be] described as a rule, rather than merely as a presumption or even a convention. The exceptions to this rule are extremely limited: a patentee must ‘evinced [] a clear intent’ to limit ‘a’ or ‘an’ to ‘one.’ . . . An exception to the general rule that ‘a’ or ‘an’ means more than one only arises where the language of the claims themselves, the specification, or the prosecution history necessitate a departure from the rule.” *Id.* at 1342–43 (quoting *KCJ Corp. v. Kinetic Concepts, Inc.*, 223 F.3d 1351, 1356 (Fed. Cir. 2000)) (alterations in original).

Just two weeks after stating this “rule,” however, the Federal Circuit found that the exception (singular meaning) applied based on the claims and written description in *Tivo, Inc. v. Echostar Communications Corp.*, 516 F.3d 1290, 1303–04 (Fed. Cir. 2008) (“The pertinent claim language refers to ‘assembl[ing] said video and audio components into an MPEG stream,’ which in context clearly indicates that two separate components are assembled into a single stream, not that the video compo-

nents are assembled into one stream and the audio components into a second stream.”). More recently, the Federal Circuit addressed *Baldwin* directly, holding that “*Baldwin*, however, does not set a hard and fast rule that ‘a’ always means one or more than one.” *Harari v. Lee*, 656 F.3d 1331, 1342 (Fed. Cir. 2011). Thus, even a simple and commonplace word, such as “a,” can have divergent meanings, based on the context of the patent and despite the Federal Circuit’s best efforts to institute “rules” for its construction. Courts must remain sensitive to the context of patent claims, and avoid rigidly applying what may appear to be an established meaning.

“Transitional phrases” are terms that are used to link the various limitations in a claim. These transitional phrases govern, among other things, whether the claim is “open” or “closed” to the presence of additional elements. Restated, these transitional phrases define whether a claim with defined limitations can be infringed by a device that has additional elements beyond what is specified in the claim. The term “consisting of” is a closed transitional phrase, while the term “comprising” is an open transitional phrase. See *AFG Indus., Inc. v. Cardinal IG Co.*, 239 F.3d 1239, 1244–45 (Fed. Cir. 2001). These terms have established meanings based on decades of consistent use in claim drafting.

Table 5.5, Table 5.6, Table 5.7, and Table 5.8 collect terms that have been commonly construed by the Federal Circuit. As the tables reflect, some of these terms have been construed differently depending on the context. Thus, courts should not woodenly adopt meanings from prior cases. Rather, they should be aware that the Federal Circuit has considered some terms in the past and has, in some cases, attributed general meanings. In every case, however, courts should carefully examine the claim term in context. When a term does not have a clear meaning from the intrinsic evidence, then the jurisprudence may offer useful guidance.

Table 5.5
Commonly Construed Terms—Articles

Term	Meaning	Citation
<i>a, an</i>	Dominant meaning: one or more.	<i>Baldwin Graphic Sys., Inc. v. Siebert</i> , 512 F.3d 1338, 1342–43 (Fed. Cir. 2008). <i>But see Braintree Labs., Inc. v. Novel Labs., Inc.</i> , 749 F.3d 1349, 1357 (Fed. Cir. 2014).
	However, sometimes means: only one.	<i>Harari v. Lee</i> , 656 F.3d 1331 (Fed. Cir. 2011); <i>Tivo, Inc. v. Echostar Commc’ns Corp.</i> , 516 F.3d 1290 (Fed. Cir. 2008).
<i>the, said</i>	Indicates identity with a previously used claim term.	<i>Baldwin Graphic Sys., Inc. v. Siebert, Inc.</i> , 512 F.3d 1338, 1342–43 (Fed. Cir. 2008).
<i>plurality</i>	At least two.	<i>York Prods., Inc. v. Cent. Tractor Farm & Family Ctr.</i> , 99 F.3d 1568, 1575 (Fed. Cir. 1996).

Term	Meaning	Citation
<i>first, second</i>	Distinguishes between repeated instances of an element or limitation.	<i>Linear Tech. Corp. v. Int'l Trade Comm'n</i> , 566 F.3d 1049 (Fed. Cir. 2009) (use of claim terms “second circuit” and “third circuit” does not require that the two circuits be entirely distinct, only that each circuit performs its stated functions); <i>Free Motion Fitness, Inc. v. Cybex Int'l</i> , 423 F.3d 1343, 1348 (Fed. Cir. 2005); <i>3M Innovative Prods. Co. v. Avery Dennison Corp.</i> , 350 F.3d 1365, 1371 (Fed. Cir. 2003).

Table 5.6
Commonly Construed Terms—Transitional Phrases

Term	Meaning	Citation
<i>comprising</i>	Is an “open” phrase and allows coverage of technologies that employ additional, unrecited elements.	<i>AFG Indus., Inc. v. Cardinal IG Co.</i> , 239 F.3d 1239, 1245 (Fed. Cir. 2001).
<i>containing</i>	Synonymous with “comprising.”	<i>Mars, Inc. v. H.J. Heinz Co.</i> , 377 F.3d 1369, 1377 (Fed. Cir. 2004).
<i>including</i>	Synonymous with “comprising.”	<i>Amgen Inc. v. Hoechst Marion Roussel, Inc.</i> , 314 F.3d 1313, 1345 (Fed. Cir. 2003). Note that in <i>Toro Co. v. White Consol. Indus., Inc.</i> , 199 F.3d 1295 (Fed. Cir. 1999), the term “including” was found to require permanency of the recited element—i.e., the claim phrase “cover including means for increasing the pressure” required the device’s restriction ring to be permanently affixed to and included as part of the air inlet cover, so claims were not literally infringed by device having separate restriction ring that was inserted and removed as a separate part.
<i>having</i>	May be “open” but does not convey an “open” meaning as strongly as “comprising.”	<i>Crystal Semiconductor Corp. v. TriTech Microelectronics Int'l, Inc.</i> , 246 F.3d 1336 (Fed. Cir. 2001); <i>Pieczenik v. Dyax Corp.</i> , 76 F. App'x 293, 296 (Fed. Cir. 2003) (unpublished).
	May be closed, depending on the context of the patent.	<i>Lampi Corp. v. Am. Power Prods., Inc.</i> , 228 F.3d 1365, 1376 (Fed. Cir. 2000).

Term	Meaning	Citation
<i>consisting of</i>	Is a “closed” phrase and excludes elements, steps, or ingredients not specified in the claims.	<i>CIAS, Inc. v. Alliance Gaming Corp.</i> , 504 F.3d 1356, 1361 (Fed. Cir. 2007); <i>AFG Indus., Inc. v. Cardinal IG Co.</i> , 239 F.3d 1239, 1245 (Fed. Cir. 2001).
<i>consisting essentially of</i>	Occupies a middle ground between “open” and “closed” claims and is open to unlisted ingredients that do not materially affect the basic and novel properties of the invention.	<i>Atlas Powder Co. v. E.I. du Pont De Nemours & Co.</i> , 750 F.2d 1569, 1574 (Fed. Cir. 1984); <i>PPG Indus. v. Guardian Indus. Corp.</i> , 156 F.3d 1351, 1354 (Fed. Cir. 1998).
<i>composed of</i>	Synonymous with “consisting essentially of.”	<i>AFG Indus., Inc. v. Cardinal IG Co.</i> , 239 F.3d 1239, 1245 (Fed. Cir. 2001).

Table 5.7
Commonly Construed Terms—Terms of Degree

Term	Meaning	Citation
<i>about</i>	Avoids a strict numerical boundary.	<i>Cen. Admixture Pharmacy Servs., Inc. v. Advanced Cardiac Sols., P.C.</i> , 482 F.3d 1347, 1355–56 (Fed. Cir. 2007).
<i>essentially</i>	Synonymous with “about.”	<i>Eiselstein v. Frank</i> , 52 F.3d 1035, 1039 (Fed. Cir. 1995).
<i>substantially</i>	Meaning is highly dependent on intrinsic evidence.	<i>Deering Precision Instruments, L.L.C. v. Vector Distrib. Sys., Inc.</i> , 347 F.3d 1314, 1322 (Fed. Cir. 2003) (construing the term “substantially in an imaginary plane.”); <i>Epcon Gas Sys., Inc. v. Bauer Compressors, Inc.</i> , 279 F.3d 1022 (Fed. Cir. 2002) (construing the terms “substantially constant” and “substantially below”); <i>Zodiac Pool Care, Inc. v. Hoffinger Indus., Inc.</i> , 206 F.3d 1408 (Fed. Cir. 2000) (construing the term “substantially inward”); <i>York Prods., Inc. v. Cent. Tractor Farm & Family Ctr.</i> , 99 F.3d 1568 (Fed. Cir. 1996) (construing the term “substantially the entire height thereof”); <i>Tex. Instruments Inc. v. Cypress Semiconductor Corp.</i> , 90 F.3d 1558 (Fed. Cir. 1996) (construing the term “substantially in the common plane”).

Term	Meaning	Citation
<i>up to about</i>	May include or exclude the endpoint, depending on the context. Where the endpoint is numeric (e.g., up to about 10%), the endpoint may be included; whereas, where the endpoint is physical (e.g., painting the wall up to about the door), the endpoint may be excluded.	<i>AK Steel Corp. v. Sollac</i> , 344 F.3d 1234 (Fed. Cir. 2003).
<i>surround</i>	To encircle on all sides simultaneously.	<i>Libman Co. v. Quickie Mfg. Corp.</i> , 74 F. App'x 900, 904–05 (Fed. Cir. 2003) (unpublished) (heavy reliance on dictionary definition).
<i>in, between, within</i>	Not required to be completely or continuously in, between or within; between may be satisfied even if extension beyond boundaries.	<i>Foster v. Hallco Mfg. Co.</i> , 1997 U.S. App. LEXIS 18989, 1997 WL 419391 (Fed. Cir. 1997) (unpublished) (heavy reliance on dictionary definition).
<i>to</i>	When A travels “to” B, it is sufficient to travel on a pathway with B as a destination, possibly visiting intervening components.	<i>Cybor Corp. v. FAS Techs., Inc.</i> , 138 F.3d 1448, 1458–59 (Fed. Cir. 1998).
<i>defined</i>	Can be used to mean that one element creates or forms the outline or shape of another element.	<i>Rival Co. v. Sunbeam Corp.</i> , 185 F.3d 885 (table) (Fed. Cir. 1999).

Table 5.8
Commonly Construed Terms—Other

Term	Meaning	Citation
<i>whereby</i>	A “whereby” clause that merely states the result of the limitations in the claim adds nothing to the patentability or substance of the claim.	<i>Hoffer v. Microsoft Corp.</i> , 405 F.3d 1326, 1329 (Fed. Cir. 2005); <i>Tex. Instruments Inc. v. U.S. Int’l Trade Comm’n</i> , 988 F.2d 1165, 1172 (Fed. Cir. 1993).
	However, a “whereby” clause that sets forth a structural limitation and not merely the results achieved by the claimed structure is a positive limitation of the claim.	<i>Scheinman v. Zalkind</i> , 112 F.2d 1017, 1019 (C.C.P.A. 1940).
<i>standard, normal, conventional, traditional</i>	Time-dependent terms that are limited to technologies existing at the time of the invention.	<i>PC Connector Sols. LLC v. SmartDisk Corp.</i> , 406 F.3d 1359, 1363 (Fed. Cir. 2005).
<i>such as</i>	Of a kind or character about to be indicated, suggested, or exemplified; for instance.	<i>Catalina Mktg. Int’l v. Coolsavings.com, Inc.</i> , 289 F.3d 801 (Fed. Cir. 2002).
<i>adapted</i>	Fit for a purpose; capable of a purpose.	<i>Mattox v. Infotopia, Inc.</i> , 136 F. App’x 366, 369 (Fed. Cir. 2005) (unpublished).
<i>assembly</i>	A collection of parts to form a structure.	<i>Kegel Co., Inc. v. AMF Bowling, Inc.</i> , 127 F.3d 1420, 1427 (Fed. Cir. 1997).
<i>uniform</i>	Having always the same form.	<i>Middleton, Inc. v. Minn. Mining & Mfg. Co.</i> , 411 F.3d 1384, 1387 (Fed. Cir. 2002) (reliance on <i>Texas Digital</i> and “heavy presumption” rule).
<i>predetermined</i>	Determined beforehand.	<i>Koito Mfg. Co., Ltd. v. Turn-Key-Tech, LLC</i> , 381 F.3d 1142, 1147–48 (Fed. Cir. 2004).

5.2.3.4 Interpreting Terms to Preserve Validity

A maxim of patent law is that claims should be construed to preserve their validity. *Phillips*, 415 F.3d at 1327–28. However, the Federal Circuit has “not endorsed a regime in which validity analysis is a regular component of claim construction.” *Id.* at 1327. Application of the principle is limited to cases in which, after applying all the available tools of claim construction, the claim remains ambiguous. *Id.* at 1328. A proposed claim construction that preserves validity must be practicable, based on sound claim-construction principles, and must not revise or ignore the explicit language of the claim. *Id.* It must also be reasonable to infer that the USPTO would have recognized that the competing interpretation would have rendered the claim invalid. *Id.*; *Azure Networks, LLC v. CSR PLC*, 771 F.3d 1336, 1354 (Fed. Cir. 2014).

5.2.3.5 Special Case: Means-Plus-Function Claims Limited to Structures in Specification and Equivalents Thereof as of Time of Issuance

A special class of claim language is construed as means-plus-function claim terms. When a party seeks to have a term construed as a means-plus-function term, the analysis is governed by § 112(f) (formerly § 112, ¶ 6):⁵

An element in a claim for a combination may be expressed as a means or a step for performing a specified function without the recital of structure, material, or acts in support thereof, and such claim shall be construed to cover the corresponding structure, material, or acts described in the specification and equivalents thereof.

When § 112(f) is found to apply to claim language, the claim term is construed by identifying the “function” associated with the claim language, and then identifying the corresponding “structure” in the specification associated with that function. The claim is construed to be limited to those corresponding structures and their equivalents. Thus, parties frequently attempt to invoke § 112(f), as a way to narrow the scope of a patent to the particular technologies disclosed in the specification, or to invalidate the claim when the specification fails to disclose sufficient structure corresponding to the functional claim language. Chart 5.4 sets forth the framework for construing functional claims terms. The court addresses Steps 1, 2A, and 2B as part of claim construction. Step 2C—determining whether the accused device has an identical or equivalent structure to the structure in the patent specification for performing the identified function—is a question of fact for the jury.

5. The nomenclature changed from “§ 112, ¶ 6” to “§ 112(f)” upon passage of the America Invents Act of 2011.

Chart 5.4
Framework for Construing Means-Plus-Function Claims

<p>Step 1: Is term in question “means-plus-function”? Rebuttable Presumption: Inclusion of “means”</p>
<ul style="list-style-type: none"> • If the term recites “means,” then there is a rebuttable presumption that 112(f) governs. • If “means” is not recited, then there is a presumption that 112(f) does not govern, although that presumption may be rebutted by showing that the claim term used is a generic term that does not connote sufficiently definite structure and is tantamount to saying “means.”
<p>Step 2: Interpretation Process:</p>
<ul style="list-style-type: none"> • A. Identify function of term (based on claim-term language, not embodiments). • B. Identify corresponding structure, material, or act based on disclosed embodiments—claim is invalid if there is no disclosure of structures linked to the claimed function. • C. Infringement stage (question of fact): Determine whether the accused device has an identical or equivalent structure (as of the time of issuance of the patent) to that described in the patent specification for performing the function stated in the claim.

5.2.3.5.1 Step 1: Is the Term in Question “Means-Plus-Function”?

When presented with a request to invoke § 112(f), the court must first determine if that section applies. Means-plus-function claiming applies only to “purely functional limitations that do not provide the structure that performs the recited function.” *DePuy Spine, Inc. v. Medtronic Sofamor Danek, Inc.*, 469 F.3d 1005, 1023 (Fed. Cir. 2006). There is a rebuttable presumption that § 112(f), applies “[i]f the word ‘means’ appears in a claim element in association with a function.” *Callicrate v. Wadsworth Mfg., Inc.*, 427 F.3d 1361, 1368 (Fed. Cir. 2005). The use of the term “means” in a claim limitation typically implies that the inventor used the means-plus-function claim format, which invokes the associated statutory limits on the literal scope of that claim limitation. See *Greenberg v. Ethicon Endo-Surgery, Inc.*, 91 F.3d 1580, 1584 (Fed. Cir. 1996). Nonetheless, this implication does not apply where the claim language itself provides the structure that performs the recited function. See *Phillips*, 415 F.3d 1303 (finding that a claim limitation stating “means disposed inside the shell for increasing its load bearing capacity comprising internal steel baffles” provides the relevant structure (“internal steel baffles”) and hence is not limited to the embodiments in the specification and equivalents thereof); *Cole v. Kimberly-Clark Corp.*, 102 F.3d 524, 531 (Fed. Cir. 1996) (finding that use of the phrase “perforation means” does not invoke § 112(f)).

When a claim limitation lacks the term “means,” there is a rebuttable presumption that § 112(f) does not apply. This presumption against construing such limitations under § 112(f) used to be characterized as a “strong” presumption. *See, e.g., Lighting World, Inc. v. Birchwood Lighting, Inc.*, 382 F.3d 1354, 1358 (Fed. Cir. 2004); *Inventio AG v. ThyssenKrupp Elevator Americas Corp.*, 649 F.3d 1350, 1358 (Fed. Cir. 2011). The en banc court thereafter revoked this characterization of the presumption as “strong.” *Williamson v. Citrix Online LLC*, 2015 U.S. App. LEXIS 10082, 2015 WL 3687459 at *7 (Fed. Cir. 2015) (en banc). In recharacterizing the presumption, *Williamson* explained the standard for overcoming it, stating that a term lacking “means” will nonetheless be construed under § 112(f) if the “challenger demonstrates that the claim fails to recite sufficiently definite structure or else recites function without reciting sufficient structure for performing that function.” *Id.* at *7. The focus is on the claim language as a whole, not just the isolated term that is akin to “means.” *Id.* at *8. Generic terms such as “mechanism,” “element,” “device” and other such terms that do not connote sufficiently definite structure in the context of the overall claim are tantamount to stating “means,” and therefore may be construed pursuant to § 112(f) if nothing else in the claim provides sufficient structure. *Id.* at *8. The Federal Circuit has referred to such “black box” words as “nonce” words, although this characterization may breed confusion, considering that “nonce” words are commonly defined as words invented for a particular occasion. *See, e.g.,* American Heritage Dictionary of the English Language, Fifth Edition (2011). Debating the “nonce” label may be unproductive—the focus should remain on whether the term, in the context of the claim as a whole, connotes a class (even a broad class) of specific structures. If so, then the term should not be construed under § 112(f).

The Federal Circuit’s decision in *Media Rights Techs. v. Capital One Financial Corp.*, 800 F.3d 1366 (Fed. Cir. 2015) illustrates the effect of *Williamson*. The court found claims reciting a “compliance mechanism” to be governed by § 112(f) for lack of a definite structure, and consequently invalid for indefiniteness owing to the absence of corresponding structure in the specification.

5.2.3.5.2 Step 2: Interpretation of Means-Plus-Function Claim Terms

5.2.3.5.2.1 Step 2A: Identify Claim-Term Function

If § 112(f) applies to a claim term, then the court must first identify the function of that term. It is important to identify the function associated with means-plus-function claim language before identifying the corresponding structure, material, or acts, and not to confuse these two analytically separate steps. *See JVW Enters., Inc. v. Interact Accessories, Inc.*, 424 F.3d 1324, 1330 (Fed. Cir. 2005) (“Determining a claimed function and identifying structure corresponding to that function involve distinct, albeit related, steps that must occur in a particular order.”). Errors arise when courts attempt to identify the function of a claimed invention based on its working embodiment, rather than solely based on the claim language. *Id.* Attributing functions to a working device, rather than focusing on the claim language, may wrongly sweep additional functions into the claim. *Id.*

5.2.3.5.2.2 Step 2B: Identify “Corresponding Structure, Material, or Acts”

After identifying the claimed function, the court must identify the corresponding structure in the specification. A proper construction should account for “all structure in the specification corresponding to the claimed function.” *Callicrate v. Wadsworth Mfg., Inc.*, 427 F.3d 1361, 1369 (Fed. Cir. 2005). It is error to limit the corresponding structure to just the preferred embodiment. *Id.*

If there is no structure in the specification that corresponds to the claimed function, then the claim is invalid as indefinite, because it cannot be construed. *See, e.g., Williamson*, 2015 U.S. App. LEXIS 10082, 2015 WL 3687459 at *10 (finding claimed “distributed learning control module” governed by § 112(f) and unsupported by structure in specification for lack of an algorithm to perform the claimed function); *Function Media, LLC v. Google, Inc.*, 708 F.3d 1310, 1318 (Fed. Cir. 2013) (finding claimed “means for transmitting” indefinite because “there is no specific algorithm disclosed in prose, as a mathematical formula, in flow charts, or otherwise”); *Robert Bosch, LLC v. Snap-On Inc.*, 769 F.3d 1094, 1100 (Fed. Cir. 2014) (finding claimed “program recognition device” requiring of § 112(f) interpretation, and invalid for lack of structural guidance in specification). Any such finding must be supported by clear and convincing evidence. *See Bancorp Servs., L.L.C. v. Hartford Life Ins. Co.*, 359 F.3d 1367, 1371 (Fed. Cir. 2004).

5.2.3.5.2.3 Step 2C: “Equivalents Thereof”

In addition to structures, materials, or acts of the embodiments described in the patent’s specification, the patentee is entitled to “equivalents thereof” as of the time the patent issued. Unlike the determination of function and corresponding structure, material, or acts that are clearly part of claim construction, the “equivalents” issue arises in the context of the infringement determination. The fact-finder must determine whether the means in the accused device or method performs the function stated in the claim in the same or an equivalent manner as the corresponding structures, materials, or acts set forth in the specification. *See Palumbo v. Don-Joy Co.*, 762 F.2d 969 (Fed. Cir. 1985).

5.2.3.5.2.4 Specific Rule for Means-Plus-Function Claims in the Computer Software Context

The Federal Circuit has underscored that computer-based inventions pose special problems for interpreting means-plus-function claims. Merely pointing to a “computer” does not provide sufficient structure in a software or computer means-plus-function claim. Rather, the Federal Circuit has held that “a means-plus-function claim element for which the only disclosed structure is a general purpose computer is invalid if the specification fails to disclose an algorithm for performing the claimed function.” *Net MoneyIN, Inc. v. VeriSign, Inc.*, 545 F.3d 1359, 1367 (Fed. Cir. 2008). That is, “if a patentee has invoked computer-implemented means-plus-function claiming, the corresponding structure in the specification for the computer implemented function must be an algorithm unless a general purpose computer is

sufficient for performing the function.” *Apple v. Motorola*, 757 F.3d 1286, 1298 (Fed. Cir. 2014) (citing *Aristocrat Techs. Australia v. Int’l Game Tech.*, 521 F.3d 1328, 1331 (Fed. Cir. 2008)) (emphasis omitted). The court has explained it is not adequate to “simply describe[] the function to be performed.” Rather the specification must describe how the system “ensures those functions are performed.” *BlackBoard v. Desire2Learn, Inc.*, 574 F.3d 1371, 1384 (Fed. Cir. 2009). Such an algorithm may be expressed “in any understandable terms including as a mathematical formula, in prose, or as a flow chart, or in any other manner that provides sufficient structure to a person of ordinary skill in the art.” *Chi. Bd. Options Exch., Inc. v. Int’l Sec. Exch., LLC*, 748 F.3d 1134, 1141 (Fed. Cir. 2014) (finding specification adequately describes algorithm for “‘identifying a counterpart order’ on a pro rata basis”); *Triton Tech of Tex., LLC v. Nintendo of Am., Inc.*, 753 F.3d 1375, 1379 (Fed. Cir. 2014) (finding claim to “integrator means” invalid because specification reference to “numerical integration” does not disclose an algorithm—that is, a step-by-step procedure—for performing the claimed function); *Eon Corp. v. AT&T Mobility LLC*, 785 F.3d 616, 624 (Fed. Cir. 2015) (finding means-plus-function claims invalid for lack of disclosure of detailed computer algorithm.)

Furthermore, the Federal Circuit has held that it is irrelevant to the § 112(f) analysis whether a person skilled in the art would know how to write a program to perform the claimed function. This is only relevant to enablement, not indefiniteness. *BlackBoard*, 574 F.3d at 1384–85. When the claim element does not use means-plus-function language, the Federal Circuit does not require disclosure of a particular algorithm. *Apple*, 757 F.3d at 1298 (“The correct inquiry, when ‘means’ is absent from a limitation, is whether the limitation, read in light of the remaining claim language, specification, prosecution history, and relevant extrinsic evidence, has sufficiently definite structure to a person of ordinary skill in the art,” and finding that claim term “heuristic” is sufficiently structural to avoid § 112(f) interpretation).

5.2.4 Product-by-Process Claims

Product claims which include in their limitations the process by which that product is made, for example, a claim to a product “produced by” or “obtainable by” a certain method, are known as “product-by-process” claims. In 2009, the Federal Circuit held en banc that such product-by-process claims must be construed to be limited to products produced by the stated process. *Abbott Labs.*, 566 F.3d at 1291–95.

In doing so, the court reaffirmed its holding in *Atlantic Thermoplastics Co. v. Faytex Corp.*, 970 F.2d 834 (Fed. Cir. 1992) that “process terms in product-by-process claims serve as limitations in determining infringement.” *Abbott Laboratories* expressly overruled the conflicting holding of *Scripps Clinic & Research Foundations v. Genentech, Inc.*, 927 F.2d 1565, 1583 (Fed. Cir. 1991), which had held that product-by-process claims were not limited to the product prepared by the process set forth in the claims. The court rejected as “unnecessary and logically unsound” any exception to the rule that limits product-by-process claims to products made by the claimed process in situations in which the structure of the product was unknown

and could only be described by the process with which it was made. *Abbott Labs.*, 566 F.3d at 1294–95.

5.2.5 Dysfunctional Claims: Mistakes and Indefiniteness

Courts must occasionally deal with dysfunctional claims. They fall into two principal categories: (1) claims that contain obvious typographical, grammatical, or other errors that render the claim unworkable; and (2) claims that may be indefinite (possibly depending on how it is construed), raising the possibility that the claim is invalid under § 112(b). The former may be obvious from the context and quite possibly due to USPTO oversight. Some mistakes are more intractable and go to the heart of the claimed invention. Deciding whether these mistakes can be fixed at all, who should fix them (the court or the USPTO), and what the consequences of changing the claims are can be challenging.

5.2.5.1 Mistakes

When issues of mistaken claim language arise, the parties often call into question the power of courts to correct mistakes in patents through the claim-construction process. Attempts to correct patents raise the threshold question of whether the district court has legal authority to correct the alleged error or omission or whether such an issue must be brought to the USPTO. The somewhat ambiguous answer is that “courts can continue to correct obvious minor typographical and clerical errors in patents,” whereas “major errors are subject only to correction by the PTO.” *Novo Indus., L.P. v. Micro Molds Corp.*, 350 F.3d 1348, 1357 (Fed. Cir. 2003).

The general rule is that “[t]he district court can correct an error only if the error is evident from the face of the patent.” *See Group One, Ltd. v. Hallmark Cards, Inc.*, 407 F.3d 1297, 1303 (Fed. Cir. 2005). “In deciding whether it had authority to correct a claim, a district court must consider any proposed correction ‘from the point of view of one skilled in the art.’” *CBT Flint Partners, LLC v. Return Path, Inc.*, 654 F.3d 1353 (Fed. Cir. 2011) (noting that because all reasonable proposals for the claims would require a computer programmed to “detect and analyze” e-mail, a person of skill in the art would readily know that the meaning of the claim requires insertion of the word “and” between the words “detect” and “analyze”). “A district court can correct a patent only if (1) the correction is not subject to reasonable debate based on consideration of the claim language and the specification *and* (2) the prosecution history does not suggest a different interpretation of the claims.” *Novo Indus.*, 350 F.3d at 1357 (emphasis added). Another general rule limiting the corrective power of courts is that “courts may not redraft claims, whether to make them operable or to sustain their validity.” *Chef America, Inc. v. Lamb-Weston, Inc.*, 358 F.3d 1371, 1374 (Fed. Cir. 2004).

Whether an error is “evident from the face of the patent” is a matter of frequent dispute. Where the applicant uses an inapt claim term, the applicant is typically held to the wording, even if the intended meaning is abundantly clear. For example, in *Chef America*, the patent dealt with a process for cooking dough. The claim language

required “heating the resulting batter-coated dough *to* a temperature in the range of about 400°F to 850°F.” *Id.* at 1371 (emphasis added). If the dough is heated “*to*” that temperature range, it would be burned to a crisp. Heating the dough “*at*” that temperature range supposedly results in a light, flaky, crispy texture, according to the patent’s specification. *See id.* at 1372. Even though it would be nonsensical to require heating the dough “*to*” 850°F, the court refused to construe the claims otherwise. The Federal Circuit affirmed, which rendered the claims noninfringed. *See id.* at 1373–74.

Courts have somewhat greater leeway to correct administrative errors attributable to the USPTO. Minor errors can be corrected by a district court, even if the prosecution history must be consulted to determine how to fix the error. For example, in *Hoffer v. Microsoft Corp.*, 405 F.3d 1326, 1331 (Fed. Cir. 2005), the Federal Circuit ruled that the district court could have fixed an error in patent-claim numbering that left a dependent claim without a reference to its independent claim, where the appropriate reference was easily determined by reference to the prosecution history. However, where the USPTO printing office omitted a block of claim text from a patent, that error was found to be beyond the district court’s corrective powers. *See Grp. One*, 407 F.3d at 1303 (“The prosecution history discloses that the missing language was required to be added by the examiner as a condition for issuance, but one cannot discern what language is missing simply by reading the patent. The district court does not have authority to correct the patent in such circumstances.”).

When a district court construes a patent claim to correct an error, that construction is generally retroactive, whereas corrections by the USPTO are prospective. *See Novo Indus*, 350 F.3d at 1356 (noting that a certificate of correction from the USPTO is “only effective for causes of action arising after it was issued”). Thus, litigants have a strong incentive to fix errors through judicial construction as opposed to petitioning the USPTO for a certificate of correction. However, the risk is that if the district court declines to fix the correction, the defective claims may be held invalid for indefiniteness, or may fail for other reasons such as noninfringement. *See, e.g., id.* at 1358 (refusing to correct patent, and holding claim indefinite).

5.2.5.2 Indefiniteness

The potentially dispositive issue of “indefiniteness” is increasingly intertwined with the claim-construction process. “Indefiniteness” is an invalidity defense based on § 112(b), which requires that the claims of a patent “particularly point[] out and distinctly claim[] the subject matter which the applicant regards as his invention.” § 112(b) (formerly § 112, ¶ 2). Explaining the “delicate balance” posed by the definiteness requirement, the Supreme Court recognized that the requirement “must take into account the inherent limitations of language” and allow a “modicum of uncertainty” to allow for appropriate incentives for innovation. *Nautilus, Inc. v. Biosig Instruments, Inc.*, 134 S. Ct. 2120, 2128 (2014). Nonetheless, the Court recognized a patent must be precise enough to afford public notice of claim scope, otherwise there would be a “zone of uncertainty which enterprise and experimentation may enter only at the risk of infringement claims.” *Id.* *Nautilus* reset the legal stand-

ard for indefiniteness, elevating it from the Federal Circuit’s prior formulation that a claim was indefinite if it was “insolubly ambiguous” and “not amenable to construction.” The new standard under *Nautilus* is that the definiteness standard requires that a patent’s claims, viewed in light of the specification and prosecution history, must “inform those skilled in the art about the scope of the invention with *reasonable certainty*.” *Id.* at 2129 (emphasis added).

Following remand from the Supreme Court, the Federal Circuit emphasized that “general principles of claim construction apply” to assessing invalidity challenges based on claim indefiniteness. *See Biosig Instruments*, 783 F.3d 1378 (quoting *Enzo Biochem*, 599 F.3d at 1332).

Adjudicating indefiniteness poses special case-management challenges, and the right approach will depend on the nature of the particular issues being litigated. The court should address indefiniteness in its scheduling order to establish at which point in the case the parties should raise indefiniteness, whether through claim construction, summary judgment, or trial.

Often, indefiniteness will be most effectively and efficiently resolved in conjunction with claim construction. If the claim scope is too imprecise to tell a skilled artisan its boundaries with reasonable certainty, then it should not be construed and should be held invalid for indefiniteness. Typically the party making the challenge will decline to proffer any construction at all, asserting that the claim cannot be construed. Thus, definiteness is a threshold inquiry within the claim-construction framework.

The indefiniteness inquiry will often fit comfortably into the *Markman* framework. For example, one common indefiniteness argument arises in the context of means-plus-function claims, whereby a party alleges that there is no structure in the specification corresponding to the claimed function. In such circumstances, the court will assess whether there is a sufficient structure in the specification to provide support to the claimed function. Absent such structure, the claim cannot be construed and is indefinite. *See Default Proof Credit Card Sys., Inc. v. Home Depot U.S.A., Inc.*, 412 F.3d 1291, 1302–03 (Fed. Cir. 2005) (invalidating claim for indefiniteness for lack of a structure in the specification corresponding to the claimed function); *Function Media, LLC v. Google, Inc.*, 708 F.3d 1310, 1319 (Fed. Cir. 2013) (invalidating claim for lack of structure in specification showing claimed transmitting function). In some cases, this determination may be clear from the four corners of the patent. In other cases, however, this determination can be fraught with technical complexity and requires substantial expert analysis. *See Iborneith IP, LLC v. Mercedes-Benz USA, LLC*, 732 F.3d 1376, 1381 (Fed. Cir. 2013) (finding disclosed algorithm in specification insufficient to adequately support claimed “computational means”).

Likewise, the court can consider during the *Markman* process whether typographical or other printing errors are sufficiently severe to render the patent uninterpretable. Minor errors are commonly overlooked as long as persons of skill in the art can still understand the claims. *See Energizer Holdings, Inc. v. Int’l Trade Comm’n*, 435 F.3d 1366, 1370 (Fed. Cir. 2006) (refusing to invalidate claim where phrase “said zinc anode” lacked an antecedent basis). However, where entire blocks

of text are missing from claims, then the public cannot reasonably be expected to appreciate their scope, and the claims are invalid. *Grp. One*, 407 F.3d at 1302.

Other issues of indefiniteness require a deeper exploration of the subject matter, and may require a mini-trial with extensive testimony from experts. Such disputes should be accounted for well in advance, preferably through the initial case-management order, so that the court may allocate enough time and resources to hear the issue properly. For example, it may be argued that a patent fails to articulate the test for determining if a claim term is infringed, and resolving this dispute may require the court to understand how skilled people in the field would measure various parameters. Exactly such a dispute arose in the Supreme Court's *Teva* case. The "molecular weight" limitation of the patent in suit could be calculated by one of three different approaches. In the challenger's view, because the claim did not say which method of calculation should be used, the claim was indefinite. *See Teva*, 135 S. Ct. at 836. Resolving such disputes requires far more than the textual analysis typically performed at a *Markman* hearing. It requires the court to understand the underlying science and to hear from experts in the field. Typical *Markman* briefing page limits may be insufficient, and this might be best handled on a full-trial record. The parties and the court should come to an early agreement on whether this will be resolved during the *Markman* hearing, and, if so, how to structure that *Markman* hearing to allow a sufficient evidentiary record, or whether to defer this dispute until trial. *See also Honeywell Int'l v. ITC*, 341 F.3d 1332, 1342 (Fed. Cir. 2003) (affirming finding of indefiniteness reached after trial in case involving process for manufacturing synthetic yarn, where "the testing results will necessarily fall within or outside the claim scope depending on the sample preparation method chosen," and "competitors trying to practice the invention or to design around it would be unable to discern the bounds of the invention."); *Halliburton*, 514 F.3d at 1252 (affirming indefiniteness finding after full factual record, because the functional claim term "fragile gel" was ambiguous as to whether it read on the prior art); *Dow Chem. Co. v. Nova Chems. Corp.*, 803 F.3d 620, 632 (Fed. Cir. 2015) (finding claim invalid for indefiniteness after expert testimony showing multiple methods to measure claimed parameter, each of which produced different results, without guidance from specification on which method to select).

Similarly, the court may wish to hear from experts and hold an evidentiary hearing on whether terms of degree and other imprecise terms render the claim invalid for indefiniteness. *See* §§ 5.1.3.1, 5.2.2.2, 5.2.3.1.5.2. For example, a claim requiring an "aesthetically pleasing" interface screen was found indefinite where even the patentee's expert could not articulate how to determine infringement. *Datamize, LLC v. Plumtree Software, Inc.*, 417 F.3d 1342, 1354 (Fed. Cir. 2005); *see also Interval Licensing LLC v. AOL, Inc.*, 766 F.3d 1364 (Fed. Cir. 2014) (finding claim indefinite for use of subjective term "unobtrusive"). Another example is a claim directed to *both* a system and a method of using that system, which is invalid because the public cannot determine the acts that constitute infringement. *IPXL Holdings, L.L.C. v. Amazon.com, Inc.*, 430 F.3d 1377, 1383–84 (Fed. Cir. 2005). These matters are often treated as "claim construction" questions, although they might more aptly be considered a question of whether the claims are indefinite as applied.

Indefiniteness is unique among claim-construction issues in that it carries a burden of proof. Because ruling that a claim cannot be construed means that the claim is invalid, the “presumption of validity,” see § 282, must be overcome by clear and convincing evidence. See *Bancorp Servs.*, 359 F.3d at 1371. In practice, however, it is difficult to imagine a circumstance in which a court would find that claim term could not be construed for purposes of a *Markman* order but is nonetheless not indefinite by clear and convincing evidence. See Anderson & Menell, 109 Nw. U. L. Rev. Online at 198–200 (discussing the interplay of claim construction and indefiniteness post-*Teva*).⁶ The Federal Circuit has viewed the standard of review of claim indefiniteness as a pure question of law pursuant to the now-overruled *Cybor* decision. In *Atmel Corp. v. Information Storage Devices, Inc.*, 198 F.3d 1374 (Fed. Cir. 1999), the Federal Circuit reasoned that

[a] determination of claim indefiniteness is a legal conclusion that is drawn from the court’s performance of its duty as the construer of patent claims. See *Personalized Media Commc’ns, LLC v. Int’l Trade Comm’n*, 161 F.3d 696, 705 (Fed. Cir. 1998). Indefiniteness, therefore, like claim construction, is a question of law that we review de novo. See *id.* at 702; cf. *Cybor Corp. v. FAS Techs., Inc.*, 138 F.3d 1448, 1456 (Fed. Cir. 1998) (en banc) (holding that claim construction is a question of law reviewed de novo).

Id. at 1378.

In view of the Supreme Court’s rejection of *Cybor*’s de novo standard of review of patent claim construction in *Teva*, there is good reason to believe that a district judge’s determination of claim indefiniteness would also fall within the Rule 52(a)(6) framework on which the Supreme Court relied. Under the Supreme Court’s *Nautilus* decision, § 112(b) requires that “a patent’s claims, viewed in light of the specification and prosecution history, inform those skilled in the art about the scope of the invention with reasonable certainty.” Thus, like claim construction, the district judge may well need to hear from skilled artisans and resolve whether the disputed claims are indefinite. Where experts disagree, the court will be required to make subsidiary factual findings based upon the credibility of the witnesses or other tools available to district judges. Hence, the lower court’s factual findings are entitled to deference by the Federal Circuit to the extent that the intrinsic evidence does not control.

The *Teva* case also sheds light on the allocation of decision-making authority between judge and jury. The majority confirmed that the Supreme Court used the phrase “within the province of the court” in *Markman* to create a distinct category of rulings with a factual basis that lie outside of the Seventh Amendment right to a jury. Like claim construction, the assessment of claim indefiniteness has no direct antecedent in pre-1791 cases. Moreover, the same functional considerations that led the Court to place claim construction within the province of the court apply to indefiniteness. Therefore, although claim indefiniteness ought not be characterized as a

6. In *Nautilus, Inc. v. Biosig Instruments, Inc.*, 134 S. Ct. 2120 (2014), the Supreme Court acknowledged controversy over, but declined to resolve, whether the clear-and-convincing standard applies for proving claim indefiniteness. See *id.* at 2130, n.10.

pure question of law, it nonetheless falls exclusively “within the province of the court.”

Even though the question of claim indefiniteness is, like claim construction, a question for the judge and not a jury, the evidentiary standard for invalidity defenses is higher (clear and convincing evidence) than for claim construction (preponderance of the evidence) owing to the Patent Act’s presumption of validity. Nonetheless, it is difficult to imagine a scenario in which a judge decides that a term cannot be construed under the preponderance standard but declines to hold that it is indefinite because of the higher clear-and-convincing standard. This seems to be a distinction without a difference, but it would nonetheless be prudent for a district judge to state in finding that the claim is indefinite the court does so by clear and convincing evidence. In essence, the preponderance and clear-and-convincing-evidence standards collapse in this situation.

The upshot of these considerations is that district judges ought to resolve the question of claim indefiniteness at the same stage as claim construction in most cases. Considering indefiniteness and meaning simultaneously will economize judicial resources, simplify patent litigation, and potentially increase settlement where subsidiary factual underpinnings entitle the district judge’s resolution to deference on appeal.

5.3 Deference to Prior Claim-Construction Rulings

Where a claim term has been construed in a prior judicial proceeding, it is not uncommon for one or more of the litigants to assert that the court is bound by or, at a minimum, should accord substantial deference to, that prior ruling. Whether, and to what extent, a prior claim-construction ruling is binding in a subsequent proceeding depends on the particular facts of each case, what decision maker provided the prior claim construction (i.e., Federal Circuit, district court, or ITC), and what legal doctrine is being asserted (i.e., issue preclusion, estoppel, or *stare decisis*).

The Supreme Court’s *Markman* decision ostensibly encourages deference to prior claim construction, noting “the importance of uniformity in the treatment of a given patent as a reason to allocate all issues of construction to the court.” *Markman*, 517 U.S. at 390. The Supreme Court acknowledged in the next paragraph, however, that “issue preclusion could not be asserted against new and independent infringement defendants even within a given jurisdiction.” Nonetheless, following *Markman*, the Federal Circuit “recognize[s] the national *stare decisis* effect that [its] decisions on claim construction have.” *Key Pharm. v. Hercon Labs. Corp.*, 161 F.3d 709, 716 (Fed. Cir. 1998); *see also Cybor*, 138 F.3d at 1455 (en banc) (“the Supreme Court endorsed this court’s role in providing national uniformity to the construction of a patent claim”).

Determining the standards for according deference to prior *Markman* orders and the application of such standards have proven complicated in practice. *See generally Rambus Inc. v. Hynix Semiconductor Inc.*, 569 F. Supp. 2d 946, 965 (N.D. Cal. 2008) (observing that “[s]ince *Markman*, various district courts have taken slightly different approaches to other courts’ claim constructions, but despite the Court’s

suggestion, none has applied *stare decisis*"). Judge Leonard Davis applied *stare decisis* in the *Eolas* case:

The issue for reconsideration is a narrow one: whether the Court is bound by the principle of *stare decisis* to adopt the Illinois District Court's construction of "executable application" as affirmed by the Federal Circuit. After a thorough analysis of the case law, the answer is yes.

Eolas Techs., Inc. v. Adobe Sys., Inc., 2011 U.S. Dist. LEXIS 157891 at *5, 2011 WL 11070303 (E.D. Tex. Sept. 23, 2011).

In an effort to promote uniformity and predictability in the treatment of patents, the Supreme Court in *Markman* held that claim construction is decided as a matter of law and is thus subject to the doctrine of *stare decisis*. *Markman*, 517 U.S. at 390–91 (“[T]reating interpretive issues as purely legal will promote (though it will not guarantee) intrajudicial certainty through the application of *stare decisis* . . .”). The Federal Circuit has likewise “recognize[d] the national *stare decisis* effect that [its] decisions on claim construction have.” *Key Pharm.*, 161 F.3d at 716.

Parties, sometimes uncritically, invoke a variety of doctrines—claim preclusion, *res judicata*, issue preclusion, collateral estoppel, judicial estoppel, and/or *stare decisis*—to attempt to constrain or obviate *Markman* determinations. The application of such doctrines is made all the more complicated by the intermediate nature of *Markman* rulings. *Markman* rulings are a means (construing claim terms) to an end (adjudicating patent validity and infringement or, more commonly, reaching a settlement agreement), not final judgments in and of themselves. An additional complicating factor is the characterization of *Markman* rulings as questions of law. As a result, determining the preclusive effect of such orders requires navigation of overlapping and not entirely cohesive civil procedure doctrines.

Before turning to the particular legal standards for according deference to prior *Markman* determinations, it will be useful to clarify the relevant terminology. There are four distinct concepts: (1) claim preclusion (and the related concept of *res judicata*); (2) issue preclusion (and the related concepts of collateral and direct estoppel); (3) judicial estoppel; and (4) *stare decisis*. Issue preclusion, judicial estoppel, and *stare decisis* are pertinent to the appropriate deference to be accorded prior claim-construction rulings; claim preclusion generally does not come into play in claim construction.

5.3.1 Distinguishing Among Preclusion and Estoppel Doctrines

Although *res judicata* has historically been interpreted broadly to encompass the binding effect of a judgment in a prior case on claims asserted in pending litigation (and hence encompassing both claim and issue preclusion), the modern trend limits *res judicata* to claim preclusion. See 18 Moore's Federal Practice § 131.10[1][b] (Matthew Bender 3d ed.). “Claim preclusion refers to the effect of a judgment in foreclosing litigation of a matter that never has been litigated, because of a determination that it should have been advanced in an earlier suit. Claim preclusion there-

fore encompasses the law of merger and bar.” *Migra v. Warren City Sch. Dist. Bd. of Educ.*, 465 U.S. 75, 77 n. 1 (1984).⁷ When a plaintiff prevails in a lawsuit arising from a particular transaction, all of the claims that the plaintiff raised *or could have raised* “merge” into that judgment and are “barred” from further litigation. See *Waid v. Merrill Area Pub. Sch.*, 91 F.3d 857, 863 (7th Cir. 1996). If the plaintiff attempts to litigate any of those claims again, the judgment itself will serve as a defense. *Markman* rulings do not themselves resolve claims to relief. They merely interpret patent claim terms. Thus, they cannot be said to constitute judgments for the purpose of “claim preclusion” as civil procedure terminology uses the term.

By contrast, the related doctrine of issue preclusion arises with some frequency in *Markman* proceedings. “Issue preclusion refers to the effect of a judgment in foreclosing the relitigation of a matter that has been litigated and decided. This effect is also referred to as direct or collateral estoppel.” *Migra*, 465 U.S. at 77 n.1 (1984); see also *Pharmacia & Upjohn Co. v. Mylan Pharm., Inc.*, 170 F.3d 1373, 1379 (Fed. Cir. 1999). Where a patentee (including those in privity) has previously litigated the scope of a patent claim term, a defendant in a subsequent lawsuit relating to the same patent claim term might assert issue preclusion to foreclose relitigation of that matter.⁸ The test for issue preclusion, however, is relatively strict and authority splits on its role in the context of prior *Markman* rulings.

Judicial estoppel is an equitable doctrine that precludes a party from adopting a position that is inconsistent with a position taken in a prior lawsuit, whether or not that issue had been actually litigated in the prior proceeding. See generally 18 Moore’s Federal Practice § 134.30 (Matthew Bender 3d ed.). “Where a party assumes a certain position in a legal proceeding, and succeeds in maintaining that position, he may not thereafter, simply because his interests have changed, assume a contrary position, especially if it be to the prejudice of the party who has acquiesced in the position formerly taken by him.” *New Hampshire v. Maine*, 532 U.S. 742, 749 (2001) (quoting *Davis v. Wakelee*, 156 U.S. 680, 689 (1895)). The purpose of the doctrine is “to protect the integrity of the judicial process by prohibiting parties from deliberately changing positions according to the exigencies of the moment.” *Id.* at 749–50 (internal marks omitted).

The doctrine of stare decisis promotes adherence to decided matters of law to foster stability and equal treatment. It takes its name from the Latin maxim *stare decisis et non quieta movere* or “to abide by the precedents and not to disturb settled points.” The strength of such adherence depends on the source of the prior decision. Stare decisis compels lower courts to follow the decisions of higher courts on ques-

7. The Restatement (Second) of Judgments adheres to the broader definition of res judicata as encompassing both claim and issue preclusion. See Restatement (Second) of Judgments, Ch. 3, intro. note (Am. Law Inst. 1982).

8. A patentee cannot use issue preclusion offensively to foreclose a defendant who was not party to that prior litigation from litigating the scope of the patent claim. See *Tex. Instruments, Inc. v. Linear Techs. Corp.*, 182 F. Supp. 2d 580, 590 (E.D. Tex. 2002). Had the Federal Circuit construed that claim term, however, the defendant might be bound under the doctrine of stare decisis. See § 5.3.4.

tions of law, whether applied to parties (or those in privity) or complete strangers to the prior proceeding. The decision of a district court is not binding precedent on a different judicial district, the same judicial district, or even the same judge in a different case, under the doctrine of stare decisis. Rather, stare decisis requires only that the later court encountering the issue give consideration and careful analysis to that sister court's decision where applicable to a similar fact pattern. See *United States v. Rodriguez-Pacheco*, 475 F.3d 434, 441 (1st Cir. 2007).

5.3.2 Issue Preclusion/Collateral Estoppel

Issue preclusion most commonly arises in the context of claim construction where a patentee who has previously litigated a patent through a *Markman* ruling seeks a fresh opportunity to construe a claim and an opposing party argues that the prior construction should govern interpretation of the term in question. Cf. *Blonder-Tongue Labs., Inc. v. Univ. of Ill. Found.*, 402 U.S. 313, 333 (1971) (holding that a patentee whose patent is invalidated after “a full and fair” opportunity to litigate its validity is collaterally estopped from relitigating the validity of the patent). The previous litigation might have ended in a settlement agreement, including possibly an order vacating the claim-construction ruling. The courts have divided on what effect, if any, to accord prior claim-construction rulings.

The general standard for issue preclusion requires that the party seeking to foreclose relitigation of an issue proves that: (1) the issue to be precluded is identical to the issue decided in the prior action; (2) the issue was actually litigated in that action; (3) the party against whom collateral estoppel is sought had a full and fair opportunity to litigate the issue in the prior action; and (4) the determination was essential to the final judgment of the prior action. See *Innovad Inc. v. Microsoft Corp.*, 260 F.3d 1326, 1334 (Fed. Cir. 2001) (citing *In re Freeman*, 30 F.3d 1459, 1465 (Fed. Cir. 1994)). Courts apply the collateral estoppel standard of the regional circuit, since issue preclusion is a procedural matter. See *RF Del.*, 326 F.3d at 1261.

5.3.2.1 Identity of Issues

The first prong of the issue preclusion test is satisfied where the patent claims (and claim terms) at issue in the *Markman* proceeding were interpreted in the prior case. See, e.g., *Dynacore Holdings Corp. v. U.S. Philips Corp.*, 243 F. Supp. 2d 31, 35 (S.D.N.Y. 2003) (same patent claims at issue); *Kollmorgen Corp. v. Yaskawa Elec. Corp.*, 147 F. Supp. 2d 464, 466 (W.D. Va. 2001) (same); *Abbott Labs. v. Dey, L.P.*, 110 F. Supp. 2d 667, 669 (N.D. Ill. 2000) (“The claim construction issues disputed in this case are the same issues litigated in the [first] case.”). When new claim terms are at issue, then collateral estoppel does not apply. See, e.g., *P.A.T., Co. v. Ultrak, Inc.*, 948 F. Supp. 1518, 1520–21 (D. Kan. 1996). Since different claims within the same patent may use the same language, the “identity of issues” prong may nonetheless be satisfied if the language and context of the language are identical. See *In re Freeman*, 30 F.3d at 1465 n.4; *Aspex Eyewear, Inc. v. Zenni Optical Inc.*, 731 F.3d 1377, 1381 (Fed. Cir. 2013) (affirming application of collateral estoppel when claims with com-

mon terms had been previously litigated and found noninfringed by devices materially identical to eyewear in present suit); *e.Digital Corp. v. Futurewei Techs., Inc.*, 772 F.3d 723, 726 (Fed. Cir. 2014) (applying collateral estoppel to reexamined patent, because previously litigated limitation remained, whereas no collateral estoppel applied to unrelated patent). Similarly, since different patents may emanate from the same specification, as in the case of divisional and continuation applications, see §§ 14.2.2.3, 14.2.3.2, 14.2.3.3, the “identity of issues” prong may nonetheless be satisfied if the language and context of the language are identical. See *Masco Corp. v. United States*, 49 Fed. Cl. 337 (Ct. Cl. 2001) (applying collateral estoppel to a continuation patent that employed identical claim language relating back to the patent construed in the earlier litigation).

5.3.2.2 Actual Litigation

To satisfy the “actual litigation” prong, the parties to the original litigation must have disputed the claim term at issue, and it must have been adjudicated by the court. See, e.g., *In re Freeman*, 30 F.3d at 1466; *Kollmorgen*, 147 F. Supp. 2d at 466 (stating that the “actually litigated” prong was met after a lengthy *Markman* hearing on the claim construction); *Abbott Labs. v. Dey, L.P.*, 110 F. Supp. 2d at 669–70 (stating the “actually litigated” prong was met because the parties “briefed and argued the issues” before the judge); Restatement (Second) of Judgments § 27 comment d (1980). The “actual litigation” test is not satisfied where an issue was raised but later abandoned, see 18 Moore’s Federal Practice § 132.03[2][e]; the court in the earlier proceeding declined to rule on the issue, see *id.* § 132.03[4][g]; there is ambiguity as to what was actually litigated and decided, see *id.* § 132.03[2][g]. Courts usually do not consider matters resolved by stipulation to have been actually litigated. See *United States v. Young*, 804 F.2d 116, 118 (8th Cir. 1986) (“A fact established in prior litigation not by judicial resolution but by stipulation has not been ‘actually litigated’ . . .”). An exception exists, however, where the parties intend to foreclose future litigation of the issue. See *Hartley v. Mentor Corp.*, 869 F.2d 1469, 1470 (Fed. Cir. 1989); 18 Moore’s Federal Practice § 132.03[2][i][ii] (Matthew Bender 3d ed.).

5.3.2.3 Full and Fair Opportunity to Litigate

Issue preclusion requires that the underlying proceeding has afforded the party to be foreclosed from relitigation a full and fair opportunity to litigate. This means that issue preclusion can never be applied against a party not involved (or not in privity with those involved) in the prior proceeding. In *Blonder-Tongue Laboratories*, 402 U.S. at 329–34, the Supreme Court identified a range of factors bearing on whether a patentee had a full and fair chance to litigate the validity of a patent: choice of forum; incentive to litigate; if the issue is obviousness, whether the first validity determination used the standards announced in *Graham v. John Deere Co.*, 383 U.S. 1, 12–24 (1966); whether opinions filed in the first case suggest that the prior case was one of those rare instances where the court or jury failed to grasp the technical subject matter and issues; and whether, without fault of its own, the pa-

tentee was deprived of crucial evidence or witnesses in the prior litigation. The Court concluded that there is no “automatic formula” for assessing this prong and that “[i]n the end, decision will necessarily rest on the trial courts’ sense of justice and equity.” *Id.* at 334. Where the prior court has conducted a *Markman* hearing in which the parties were afforded the ability to present their positions and respond, the “full and fair opportunity to litigate” requirement has been satisfied. *See Kollmorgen*, 147 F. Supp. 2d at 466 (stating that a lengthy *Markman* hearing on the claim construction satisfied the requirement); *TM Patents, L.P. v. IBM Corp.*, 72 F. Supp. 2d 370, 375 (S.D.N.Y. 1999) (noting that both parties agreed that there was a full and fair opportunity to litigate because a *Markman* hearing occurred).

5.3.2.4 Determination Was Essential to the Final Judgment

The final prong of the issue preclusion test has attracted the most controversy in the claim-construction context. It can usefully be divided into two separate inquiries: whether (1) the prior ruling was “final”; and (2) the prior ruling was essential to the judgment.

5.3.2.4.1 Finality

The question of whether a prior claim construction constitutes a final judgment can be characterized along a spectrum. At the easier end of the spectrum, where the court in the prior proceeding interprets the pertinent claim language and issues a final, appealable judgment on validity or infringement, the finality requirement is satisfied. *See, e.g., In re Freeman*, 30 F.3d at 1466 (“[J]udicial statements regarding the scope of patent claims are entitled to collateral estoppel effect in a subsequent infringement suit only to the extent that determination of scope was essential to a final judgment on the question of validity or infringement.”) (quoting *A.B. Dick Co. v. Burroughs Corp.*, 713 F.2d 700, 704 (Fed. Cir. 1983)); *Home Diagnostics Inc. v. Lifescan, Inc.*, 120 F. Supp. 2d 864, 870 (N.D. Cal. 2000) (noting there must be a final judgment on validity or infringement for collateral estoppel to apply).

Issue preclusion can also arise out of a ruling granting summary judgment, *see Stevenson v. Sears, Roebuck & Co.*, 713 F.2d 705, 712 (Fed. Cir. 1983); *Sec. People, Inc. v. Medeco Sec. Locks, Inc.*, 59 F. Supp. 2d 1040 (N.D. Cal. 1999), *aff’d mem.*, 243 F.3d 555 (Fed. Cir. 2000), although denial of summary judgment or a grant of partial summary judgment usually does not have preclusive effect. *See Syntex Pharm. Int’l, Ltd. v. K-Line Pharm., Ltd.*, 905 F.2d 1525, 1526 (Fed. Cir. 1990) (noting that an order granting summary judgment of infringement of a patent and denying the alleged infringer’s motion for summary judgment of invalidity did not present an appealable final judgment).

Similarly, the Federal Circuit held in *Transonic Systems, Inc. v. Non-Invasive Medical Technologies Corp.*, 75 F. App’x 765, 774 (Fed. Cir. 2003) (unpublished), that claim constructions conducted for purposes of a preliminary injunction ruling are not binding, even in the same litigation. Drawing on the Supreme Court’s statement in *University of Texas v. Camenisch*, 451 U.S. 390, 395 (1981), that “findings of fact and conclusions of law made by a court granting a preliminary injunction are not

binding at trial on the merits,” the Federal Circuit views claim constructions reached during appeals from a grant of a preliminary injunction to be tentative. Hence, these preliminary constructions are not binding on the district court in subsequent proceedings. See *Guttman, Inc. v. Kopykake Enters.*, 302 F.3d 1352, 1361 (Fed. Cir. 2002) (“District courts may engage in a rolling claim construction, in which the court revisits and alters its interpretation of the claim terms as its understanding of the technology evolves.”); *Transonic Sys.*, 75 F. App’x at 774. Therefore, claim constructions made in the context of preliminary injunction motions should not be considered final judgments, as the district court remains “at liberty to change the construction of a claim term as the record in a case evolves after a preliminary injunction appeal.” See *Transonic Sys.*, 75 F. App’x at 774.

Courts are deeply divided on the issue of finality when the outcome of the prior proceeding is a settlement. Several courts have interpreted the “finality” requirement liberally and functionally, looking to whether the previous judgment is sufficiently firm to be accorded preclusive effect. In *TM Patents*, 72 F. Supp. 2d at 375–77, the defendant sought to hold the patentee to a claim construction rendered in a case resolved through settlement. While recognizing that the settlement did not result in a final, appealable judgment, the court nonetheless determined that the prior claim construction was entitled to preclusive effect. Seeking to elevate substance over form, the court focused on the careful consideration of the issues during the prior litigation and drew upon the Supreme Court’s policy ruminations in *Markman*, which emphasized the importance of “uniformity in treatment of a given patent.” See *Markman*, 517 U.S. at 390. The court recast “finality” for issue preclusion purposes as whether the prior litigation passed a stage for which there is “no really good reason for permitting [an issue] to be litigated again.” *TM Patents*, 72 F. Supp. 2d at 376 (quoting *Lummus Co. v. Commonwealth Oil Ref. Co.*, 297 F.2d 80, 89 (2d Cir. 1961)). The court also noted that the patentee voluntarily entered into the settlement agreement, and the *Markman* ruling was not vacated as part of the settlement.

Although some other courts have since followed *TM Patents*’ application of collateral estoppel in the context of settlements following *Markman* rulings, see, e.g., *Edberg v. CPI-The Alternative Supplier, Inc.*, 156 F. Supp. 2d 190 (D. Conn. 2001), a contrary line of cases emerged holding that *Markman* rulings from cases that settled were not final and hence not properly entitled to preclusive effect. See *Lincoln Nat. Life Ins. Co. v. Jackson Nat. Life Ins. Co.*, 2013 U.S. Dist. LEXIS 155502, 2013 WL 5874448 (N.D. Ind. 2013) (declining to apply collateral estoppel against patentee based on prior adverse ruling resolved through settlement); *Kollmorgen*, 147 F. Supp. 2d 464; *Graco Children’s Prods., Inc. v. Regalo Int’l*, 77 F. Supp. 2d 660 (E.D. Pa. 1999). The cases read the Supreme Court’s policy discussion in the *Markman* case as merely recognizing the importance of uniformity, not changing the fundamental principles for issue preclusion. The *Graco Children’s Products* court expressed concern that granting preclusive effect to cases settled after claim constructions might discourage settlement and encourage appeals by patentees who obtained favorable verdicts, but nonetheless needed to correct what they believed to be unduly narrow or otherwise flawed claim constructions.

The preclusive effect of claim-construction rulings in cases resolved by settlement came before the Federal Circuit in *RF Delaware*, 326 F.3d 1255. *See also Dana v. E.S. Originals, Inc.*, 342 F.3d 1320 (Fed. Cir. 2003). Without expressly resolving the district court conflict, the Federal Circuit, applying Eleventh Circuit law, applied a stringent standard to the question of finality: “if the parties to a suit enter into an *extrajudicial settlement or compromise*, there is no judgment, and future litigation is not barred by *res judicata* or collateral estoppel . . .” *RF Del.*, 326 F.3d at 1261 (quoting *Kaspar Wire Works, Inc. v. Leco Eng’g & Mach., Inc.*, 575 F.2d 530, 542 (5th Cir. 1978)). The Federal Circuit drew no implication from the Supreme Court’s *Markman* language on which the *TM Patents* court seized. Nonetheless, the court included some language inclined toward a functional approach to finality: “[f]or purposes of issue preclusion . . . , ‘final judgment’ includes any prior adjudication of an issue in another action that is determined to be sufficiently firm to be accorded conclusive effect.” *Id.* at 1261 (quoting *Christo v. Padgett*, 223 F.3d 1324, 1339 n.47 (11th Cir. 2002) (citing Restatement (Second) of Judgments § 13 (1980))). Whether a decision is “sufficiently firm” depends on whether the parties were “fully heard.” *Id.* The Federal Circuit noted that the Eleventh Circuit held that a prior district court order issued after an evidentiary hearing satisfied the finality standard because the district court notified the parties of possible preclusive effect, considered the findings final, and entered a final order approving the proposed settlement. *Id.* at 1261 (quoting *Christo v. Padgett*, 223 F.3d at 1339). In *RF Delaware*, the Federal Circuit denied preclusive effect of the earlier *Markman* ruling on the grounds that there was no evidence that a *Markman* hearing had been conducted in the earlier case, the parties did not have notice that the court’s order could have preclusive effect, and no final order approving the settlement was ever entered. *Id.*

The Federal Circuit further addressed the preclusive effect of stipulated constructions and settlements in *Pfizer, Inc. v. Teva Pharmaceuticals, USA, Inc.*, 429 F.3d 1364 (Fed. Cir. 2005). Because the parties in the prior proceeding had stipulated that the agreed claim interpretation was for purposes of that litigation only, the Federal Circuit held that the agreement could not preclude litigation in a later case. Looking to jurisprudence on the interpretation of consent decrees, the court declared that “the scope of a consent decree must be discerned within its four corners’ and the conditions upon which a party has consented to waive its right to litigate particular issues ‘must be respected.’” *Id.* at 1376 (quoting *United States v. Armour & Co.*, 402 U.S. 673, 682 (1971) and citing *In re Graham*, 973 F.2d 1089, 1097 (3d Cir. 1992) (noting that the Third Circuit defers to the intent of parties concerning the preclusive effect of agreed facts or claims in consent decrees and stipulations)).

5.3.2.4.2 Essential to the Final Judgment

A final requirement for a prior *Markman* ruling to foreclose later interpretation over a claim term is that the earlier construction was essential to the final judgment. When the prior action turns upon resolution of a particular claim term or terms, the court’s construction of other claim terms is “merely dictum, and therefore has no issue preclusive effect.” *See, e.g., Guardian Media Techs., Ltd. v. Acer Am. Corp.*, 2013 U.S. Dist. LEXIS 63044, 2013 WL 1866901 at *10 (E.D. Tex. 2013) (finding no pre-

clusion where contested term was related to, but not identical to, term that was focus of prior judgment); *Phonometrics, Inc. v. N. Telecom Inc.*, 133 F.3d 1459, 1464 (Fed. Cir. 1998). To have a preclusive effect, the earlier court's interpretation of the particular claim had to be the reason for the previous outcome. *TecSec, Inc. v. IBM Corp.*, 731 F.3d 1336, 1344 (Fed. Cir. 2013) (finding no estoppel where earlier claim construction was not critical to prior appeal); *Jackson Jordan, Inc. v. Plasser Am. Corp.*, 747 F.2d 1567, 1577 (Fed. Cir. 1984).

A related principle is that issues of claim construction that cannot be appealed cannot be accorded preclusive effect. See *Hartley*, 869 F.2d at 1472. Thus, courts will not attach preclusive effect where a patentee loses on the issue of claim interpretation but nonetheless prevails on validity and infringement because the patentee lacked a basis for appealing the *Markman* ruling. See *Graco*, 77 F. Supp. 2d at 664–65; *Schering Corp. v. Amgen, Inc.*, 35 F. Supp. 2d 375, 377 n.2 (D. Del. 1999), *aff'd in part*, 222 F.3d 1347 (Fed. Cir. 2000).

5.3.2.5 Reasoned Deference as a Prudent Approach to Issue Preclusion

In cases in which the basis for applying issue preclusion is open to question, many courts have taken the approach of according prior *Markman* rulings “reasoned deference” in assessing the disputed claim terms. See, e.g., *Finisar Corp. v. DirecTV Group, Inc.*, 523 F.3d 1323, 1329 (Fed. Cir. 2008) (noting that “in the interests of uniformity and correctness,” the Federal Circuit “consults the claim analysis of different district courts on the identical terms in the context of the same patent.”); *CoStar Realty Information, Inc. v. CIVIX-DDI, LLC*, 2013 U.S. Dist. LEXIS 135448, 2013 WL 5346440 at *5 (N.D. Ill. 2013) (“Courts in this district have stopped short of affording complete deference to prior non-preclusive district court claim constructions, instead giving them the status of only persuasive authority.”); *Visto Corp. v. Sproqit Techs., Inc.*, 445 F. Supp. 2d 1104, 1108 (N.D. Cal. 2006). Where no new arguments are offered, no new foundation is laid, and there has been no change in the applicable standards for construing claims, courts generally adopt the prior construction unless it is clearly unsound. Where new argument and evidence is adduced, then the review is more probing and independent. Even in cases in which courts have determined that collateral estoppel applies, they have nonetheless made some independent assessment of claim construction. Thus, even the *TM Patents* court, which held that a *Markman* ruling from an earlier case that settled prior to trial precluded relitigation of claim meaning, used the “reasoned deference” approach as a judicial backstop: “Finally, I have to observe that this issue of collateral estoppel . . . is of marginal practical importance, because I agree with just about everything Judge Young did when he construed the claims in the EMC action.” See *TM Patents*, 72 F. Supp. 2d at 370.

5.3.3 Judicial Estoppel

The Federal Circuit has recognized the applicability of the equitable doctrine of judicial estoppel in the context of claim construction. See *Biomedical Patent Mgmt. Corp. v. Cal. Dep't of Health Servs.*, 505 F.3d 1328, 1341 (Fed. Cir. 2007); *Harris Corp. v. Ericsson*, 417 F.3d 1241 (Fed. Cir. 2005); *RF Del.*, 326 F.3d 1255. As an equitable doctrine, the contours of judicial estoppel are relatively flexible. Although “[t]he circumstances under which judicial estoppel may appropriately be invoked are probably not reducible to any general formulation of principle,” *Allen v. Zurich Ins. Co.*, 667 F.2d 1162, 1166 (4th Cir. 1982), the Supreme Court has emphasized three factors to consider in determining whether the doctrine applies: (1) whether a party’s later position is “clearly inconsistent” with its earlier position; (2) whether the party succeeded in persuading a court to accept that party’s earlier position, so that judicial acceptance of an inconsistent position in a later proceeding would create “the perception that either the first or second court was misled”; and (3) whether the party seeking to assert an inconsistent position would derive an unfair advantage or impose an unfair detriment on the opposing party if not estopped. See *New Hampshire v. Maine*, 532 U.S. at 750–51; *Global Sessions LP v. Comerica Bank*, 2014 U.S. Dist. LEXIS 125271, 2014 WL 4415996 at *12 (W.D. Tex. 2014) (finding no judicial estoppel where prior construction was court’s construction rather than that the patentee advanced and neither party was free of machinations).

The requirements for judicial estoppel partially overlap with the standard for issue preclusion (such as the element of identity of issues), but there are substantial differences as well. Unlike issue preclusion, judicial estoppel does not require strict mutuality, *Ryan Operations G.P. v. Santiam-Midwest Lumber Co.*, 81 F.3d 355, 360 (3d Cir. 1996) (stating that judicial estoppel does not require privity), or even that the issue had been actually litigated in the prior proceeding. See *Lowery v. Stovall*, 92 F.3d 219, 223 n.3 (4th Cir. 1996). On the other hand, judicial estoppel typically requires strong evidence of improper intent to mislead a tribunal.

Judicial estoppel is also closely related to equitable estoppel. See *id.* Unlike a party asserting equitable estoppel, a party asserting judicial estoppel does not have to prove detrimental reliance because judicial estoppel is designed to protect the integrity of the courts rather than any interests of the litigants. See *Teledyne Indus., Inc. v. NLRB*, 911 F.2d 1214, 1220 (6th Cir. 1990). Therefore, judicial estoppel may apply in a particular case “where neither collateral estoppel nor equitable estoppel . . . would apply.” *Allen*, 667 F.2d at 1166–67.

As with issue preclusion and other nonpatent procedural issues, courts apply the standards for judicial estoppel developed by their regional circuit. See *Lampi Corp. v. Am. Power Prods., Inc.*, 228 F.3d 1365, 1377 (Fed. Cir. 2000). Such standards vary across the circuits. For example, although most circuits do not require mutuality of judicial estoppel, some courts limit the doctrine to those who were party to (or in privity with a party to) the prior proceeding. See *Nichols v. Scott*, 69 F.3d 1255, 1272 n.33 (5th Cir. 1995). The relative importance of particular factors varies as well.

Some circuits consider intent—whether the inconsistency in position was for the purpose of gaining unfair advantage—to be most determinative. *See Lowery*, 92 F.3d at 224.⁹

5.3.4 Stare Decisis

Prior to the Supreme Court’s *Teva* decision, the Federal Circuit held that lower courts must adhere to prior claim-construction determinations by the Federal Circuit even if the claim construction is applied to a party who was not involved in the prior litigation. *See, e.g., Amgen, Inc. v. F. Hoffmann–La Roche Ltd.*, 494 F. Supp. 2d 54, 60 (D. Mass. 2007); *Tate Access Floors, Inc. v. Interface Architectural Res., Inc.*, 185 F. Supp. 2d 588, 595 (D. Md. 2002); *Wang Labs., Inc. v. Oki Elec. Indus. Co., Ltd.*, 15 F. Supp. 2d 166, 175 (D. Mass. 1998) (holding that a prior Federal Circuit claim construction was binding against a party that was not a party to (or allowed intervention in) prior litigation interpreting the claim term in question). By expressly recognizing a factual component to claim construction, the *Teva* decision casts doubt on this line of cases. Where the basis for the prior Federal Circuit decision is intrinsic evidence, the Federal Circuit’s interpretation will typically control. However, litigants who did not participate in the prior case and who have an alternative basis for interpreting the claim are entitled to a fair opportunity to pursue their interpretive analysis.

A claim-construction decision of a district court is not binding precedent on a different judicial district, the same judicial district, or even the same judge in a different case under the doctrine of stare decisis. Rather, stare decisis requires only that the later court encountering the issue give consideration and careful analysis to that sister court’s decision where applicable to a similar fact pattern. *See Pinpoint Inc. v. Hotwire, Inc.*, 2013 U.S. Dist. LEXIS 38371, 2013 WL 1174688, *8 (N.D. Ill. 2013); *Amgen, Inc. v. F. Hoffmann–La Roche Ltd.*, 494 F. Supp. 2d 54, 60 (D. Mass. 2007) (citing *Rodriguez-Pacheco*, 475 F.3d at 441); *Tex. Instruments, Inc. v. Linear Techs. Corp.*, 182 F. Supp. 2d 580, 589 (E.D. Tex. 2002); *cf. Finisar*, 523 F.3d at 1329 (noting that “in the interests of uniformity and correctness,” the Federal Circuit “consults the claim analysis of different district courts on the identical terms in the context of the same patent.”). Courts sometimes accord prior decisions from within their district somewhat greater consideration than those decided outside the district. *See, e.g., Visto*, 445 F. Supp. 2d at 1107–08 (noting that intrajudicial uniformity warrants an even higher level of deference); *Verizon Cal. Inc. v. Ronald A. Katz Tech. Licensing, P.A.*, 326 F. Supp. 2d 1060, 1069 (C.D. Cal. 2003).

9. The Federal Circuit holds that judicial estoppel does not normally prevent a party from altering on appeal an unsuccessful position on claim construction that it advocated before the trial court. *See RF Del.*, 326 F.3d at 1262 (quoting *Data Gen. Corp. v. Johnson*, 78 F.3d 1556, 1565 (Fed. Cir. 1996)) (“The doctrine of judicial estoppel is that where a party *successfully* urges a particular position in a legal proceeding, it is estopped from taking a contrary position in a subsequent proceeding where its interests have changed.”).

The general rule is that a prior claim-construction decision by the Federal Circuit is binding upon district courts (and future Federal Circuit panels) being asked to construe the same term, in the same patent. *Phonometrics, Inc. v. Westin Hotel Co.*, 350 F.3d 1242, 1244 (Fed. Cir. 2003) (“under principles of *stare decisis*,” future Federal Circuit panels “will follow the claim construction set forth by” an earlier panel). The Federal Circuit has in fact “adopted the rule that prior decisions of a panel of the court are binding precedent on subsequent panels unless and until overturned in banc.” *Newell Cos. v. Kenney Mfg. Co.*, 864 F.2d 757, 765 (Fed. Cir. 1988). And that rule applies to the construction of claim terms. See *Phonometrics, Inc. v. Economy Inns of Am.*, 349 F.3d 1356, 1363–64 (Fed. Cir. 2003).

The limits of *stare decisis* are likely to be tested under the AIA’s misjoinder regime. Section 299 is producing a proliferation of lawsuits involving the same patents. Furthermore, the *Teva* decision has recognized that claim construction can involve subsidiary factual determinations. Different defendants in separate lawsuits will explore alternative theories and extrinsic evidence, which could result in divergent interpretations. When multiple cases are proceeding in parallel, each with its own claim construction (as allowed by *Teva* and the AIA nonjoinder rule), there is a strong likelihood that the first case to reach the Federal Circuit could upend the constructions reached in the other cases, thereby upsetting the framework of those cases, and requiring a “redo” of expert reports, expert depositions, summary judgment motions, and pretrial proceedings. However, district courts may be reluctant to halt their own proceedings while the lead case in a multijurisdiction suit winds its way through the appellate process. Furthermore, given the likelihood that the claims and constructions at issue in different cases might not be identical, the appeal of the lead case might not resolve the claim-construction disputes of the other pending cases. Therefore, district courts are likely to press onward with their own dockets while the leading case is appealed. After spending considerable resources on trailing cases, those courts may be reluctant to undo their own constructions once the first Federal Circuit opinion is issued. Of course, the myriad ways this could play out requires a case-by-case case-management approach and openness to new solutions, given the fundamental changes in patent law which the AIA and *Teva* have effected.

Just as issue preclusion requires an issue to have been actually *litigated* for collateral estoppel to attach, stipulations of claim meaning may not be entitled to *stare decisis* effect “because it is only the judiciary—not the parties—that declares what the law is.” *Amgen*, 494 F. Supp. 2d at 70. The court in that case noted, however, that “[s]uch agreements, of course, may, where appropriate, implicate judicial estoppel and, where a final judgment occurs, the doctrine of issue preclusion.” Also as with issue preclusion, *stare decisis* applies only to rulings that were necessary to the decision rendered. See *Miken Composites, L.L.C. v. Wilson Sporting Goods Co.*, 515 F.3d 1331, 1338 (Fed. Cir. 2008); *Zenith Radio Corp. v. United States*, 783 F.2d 184, 187 (Fed. Cir. 1986) (holding that *stare decisis* applied where the resolution of issue was a “necessary predicate” to earlier Federal Circuit ruling).

A distinct tension arises to the extent that courts look to prior *Markman* rulings under the doctrine of *stare decisis* in circumstances that do not satisfy the more exacting requirements of issue preclusion. In practice, courts have alleviated this strain

by affording a party who did not participate in that earlier action a full and fair opportunity to be heard in the later proceeding. At the same time, courts can be mindful of prior rulings. See *Tex. Instruments*, 182 F. Supp. 2d at 590 (E.D. Tex. 2002); *Sears Petroleum & Transp. Corp. v. Archer Daniels Midland Co.*, 2007 U.S. Dist. LEXIS 53576, 2007 WL 2156251, at *8, *12 (N.D.N.Y. July 24, 2007) (stating that “considerable deference should be given to those prior decisions unless overruled or undermined by subsequent legal developments, including intervening case law” before proceeding to consider arguments that had not been heard during prior claim-construction proceedings); *KX Indus., L.P. v. PUR Water Purification Prods., Inc.*, 108 F. Supp. 2d 380, 387 (D. Del. 2000) (holding that it would defer to its prior claim construction, but only “to the extent the parties do not raise new arguments”); *Tex. Instruments*, 182 F. Supp. 2d at 589–90 (expressing concern that refusing to consider a new party’s claim-construction arguments raised due process concerns and therefore granting the party’s request for a *Markman* hearing); *Townshend Intellectual Prop., L.L.C. v. Broadcom Corp.*, 2008 U.S. Dist LEXIS 7393, 2008 WL 171039 (N.D. Cal. Jan. 18, 2008) (modifying prior claim construction in light of a new party’s arguments).

As Judge Whyte has stated, “[t]his general practice accords with the insight that a fresh look at a claim construction can hone a prior court’s understanding and construction of a patent.” See *Rambus*, 569 F. Supp. 2d at 966. The Federal Circuit has noted that it “would be remiss to overlook another district court’s construction of the same claim terms in the same patent as part of [a] separate appeal.” *Finisar Corp.*, 523 F.3d at 1329. In that case, the Federal Circuit found a second district court’s claim interpretation particularly helpful where it referred to the prior construction, and noted where it disagreed. See *id.* The lesson from *Finisar* is that additional litigation can refine and sharpen courts’ understanding of an invention and that a second court should not defer to a prior court’s claim construction without questioning its accuracy.

It should be noted, however, that this practice is in tension with the Supreme Court’s understanding of *stare decisis*. See *Payne v. Tenn.*, 501 U.S. 808, 828 (1991) (observing that “[c]onsiderations in favor of *stare decisis* are at their acme in cases involving property and contract rights, where reliance interests are involved”); *Burnet v. Coronado Oil & Gas Co.*, 285 U.S. 393, 406 (1932) (Brandeis, J., dissenting) (noting that “[s]*tare decisis* is usually the wise policy, because in most matters it is more important that the applicable rule of law be settled than that it be settled right”); *Genesee Chief v. Fitzhugh*, 53 U.S. 443, 458 (1851) (explaining that “*stare decisis* is the safe and established rule of judicial policy, and should always be adhered to” when dealing with cases establishing rules of property); *Minn. Mining Co. v. Nat’l Mining Co.*, 70 U.S. 332 (1865).

Nonetheless, “while ‘most’ matters benefit from being settled rather than being settled right, claim construction appears to be an exception.” See *Rambus*, 569 F. Supp. 2d at 967. The prevailing notion among the district courts and the Federal Circuit appears to be that it is better to get a claim construction right than it is to get a claim construction settled.

5.3.5 U.S. International Trade Commission Determinations

A growing number of plaintiffs in recent years have concurrently filed complaints in both a U.S. district court and before the U.S. International Trade Commission. As an administrative agency, decisions by the ITC are not binding upon a district court. *See Tex. Instruments Inc. v. Cypress Semiconductor Corp.*, 90 F.3d 1558, 1569 (Fed. Cir. 1996) (“Congress did not intend decisions of the ITC on patent issues to have preclusive effect.”). However, as an agency that is highly focused on resolving patent infringement disputes, the rulings of the ITC would ordinarily be conferred substantial persuasive effect. *Id.* (“The district court can attribute whatever persuasive value to the prior ITC decision that it considers justified.”).

5.3.6 Patent and Trademark Office Determinations

Often, patents in litigation are also involved in reexamination proceedings before the USPTO. Particularly in these circumstances, the USPTO may have had an opportunity to construe the claims at issue in the district court litigation. However, no deference should be given to claim-construction rulings of the USPTO. The USPTO uses a different standard to construe claims than is appropriate for a district court. Whereas a district court is charged with identifying the proper construction, the USPTO is required to give claims “their broadest reasonable interpretation, consistent with the specification.” *In re Swanson*, 540 F.3d 1368, 1377–78 (Fed. Cir. 2008).

5.3.7 Motions to Vacate Claim-Construction Rulings in Connection with Settlement

Claim construction often drives settlement discussions. Parties often resolve their disputes after a claim-construction order has been issued, but prior to entry of final judgment. Occasionally, a patentee may be concerned about potential preclusive effects of an adverse claim-construction ruling in future litigation, and will file either a joint or unopposed motion to vacate that claim-construction ruling in connection with the settlement. While some district courts have granted vacatur in such cases, *see, e.g., Cisco Sys., Inc. v. Telcordia Techs., Inc.*, 590 F. Supp. 2d 828, 830 (E.D. Tex. 2008) (vacating claim-construction order), other courts have denied it on the grounds that it undermines judicial economy and is contrary to public policy. *See, e.g., Allen-Bradley Co. v. Kollmorgen Corp.*, 199 F.R.D. 316, 320 (E.D. Wis. 2001) (“[The] claim construction order, like nearly all court decisions and orders, affects interests beyond those of the parties in the present action. The benefits of settling the present action are, in short, outweighed by the systemic costs that would be incurred by vacating the court’s order.”); *RE2CON, LLC v. Telfer Oil Co.*, 2013 U.S. Dist. LEXIS 46192, 2013 WL 1325183 at *3 (E.D. Cal. 2013) (declining vacatur).

Although some courts grant vacatur with the goal of facilitating settlement, this practice, especially in patent cases, could be a false economy. It may facilitate the reassertion of weak patents and deprive other courts of the economizing benefits of

collateral estoppel. See Jeremy W. Bock, *An Empirical Study of Certain Settlement-Related Motions for Vacatur in Patent Cases*, 88 Ind. L. J. 919 (2013) (synthesizing case law and analyzing empirical data on settlement-related motions for vacatur in patent cases over a five-year period); cf. *Lear, Inc. v. Adkins*, 395 U.S. 653, 674 n.19 (1969) (noting “the public’s interest in the elimination of specious patents”); *Cardinal Chem. Co. v. Morton Int’l*, 508 U.S. 83, 100 (1993) (“[O]ur prior cases have identified a strong public interest in the finality of judgments in patent litigation.”); Jill E. Fisch, *Rewriting History: The Propriety of Eradicating Prior Decisional Law Through Settlement and Vacatur*, 76 Cornell L. Rev. 589, 593 (1991) (“[T]he effect of vacatur on the litigation process extends beyond judicial waste; it perverts the judicial decision into a negotiable commodity, engendering distortion of, and disrespect for, the role of the courts.”).

Although there is no Federal Circuit precedent that squarely addresses the merits of a district court’s decision on a motion to vacate a claim-construction order, the Supreme Court’s decision in *U.S. Bancorp Mortgage Co. v. Bonner Mall Partnership*, 513 U.S. 18 (1994) provides an analytic starting point. The Court denied a settlement-related motion to vacate a final judgment on the ground that vacatur was an “extraordinary remedy” to which equitable entitlement must be shown. *Id.* at 26. Settlement does not justify vacatur in the absence of “exceptional circumstances.” *Id.* at 29. The Federal Circuit’s guidance on the merits of settlement-related vacatur at the district court level is largely limited to a couple of concurring opinions that provide somewhat differing views. Compare *Ohio Willow Wood Co. v. Thermo-Ply, Inc.*, 629 F.3d 1374, 1376 (Fed. Cir. 2011) (Moore, J., concurring) (extending *U.S. Bancorp* to district courts and observing that “[o]nly in ‘exceptional circumstances’ should a district court grant vacatur at the request of the litigants”) (quoting *U.S. Bancorp*, 513 U.S. at 26.) with *Dana v. E.S. Originals, Inc.*, 342 F.3d 1320, 1328 (Fed. Cir. 2003) (Dyk, J., concurring) (suggesting that *U.S. Bancorp* does not apply to district courts or nonfinal orders).

In general, courts should view with skepticism a request to vacate a claim-construction order in connection with a settlement. Although granting vacatur may be expedient for the particular parties and the court, the public interest and long-term judicial economy may suffer by allowing the patentee “another bite at the apple.” The circumstances are, of course, fact-dependent. Accordingly, when presented with a settlement-related motion for vacatur, courts should consider the underlying motives for the settlement, the litigation history of the patent affected by the ruling targeted for vacatur, past patterns of behavior by the patentee, and anticompetitive ramifications, as well as potential effects on third parties.

5.4 Practical Tips for Claim Construction

5.4.1 Recognizing and Avoiding the Pitfalls of Sound-Bite and “Cite”-Bite Advocacy

Patent law is plagued with a surfeit of quotations from Federal Circuit cases that appear to support almost any proposition. The sheer quantity of published opinions

that the Federal Circuit has issued over its history is massive. The cases frequently are technically demanding, which can obscure the context around their legal rules. Moreover, important legal shifts over the Federal Circuit’s history (most recently in *Phillips*) have rendered entire lines of authority obsolete. The result is that there is a huge trove of case-law sound bites available to litigants that are no longer authoritative, but that are nonetheless cited routinely. This poses an added burden on the courts to recognize what principles are no longer good law. This subsection identifies commonly cited statements from prior cases that are no longer valid, or whose applicability has been sharply limited.

5.4.1.1 “Heavy Presumption of Ordinary Meaning”

As discussed above (*see* §§ 5.2.3.2.2, 5.2.3.2.2.2), *Texas Digital* established a “heavy presumption” that the ordinary meaning of a claim term applies. This standard was routinely cited prior to *Phillips*, but dropped from the Federal Circuit’s case law for many years in connection with *Phillips*.¹⁰ *Phillips* did not expressly abrogate the “heavy presumption” standard, and the lack of an express statement from the Federal Circuit disavowing this standard has allowed litigants to continue citing it.

Post-*Phillips*, the Federal Circuit has relied on various standards for departing from the “ordinary meaning” of a term, as discussed herein. Some articulations of the standard, such as applied in *Thorner*, 669 F.3d at 1365–66 (Fed. Cir. 2012), approach a presumption, holding that ordinary meaning should apply unless there is an explicit definition or disavowal of claim scope. Other standards, such as was articulated in *Retractable Technologies*, appear to provide a more flexible framework for determining the proper construction, as discussed herein. More recently, various panels of the Federal Circuit have revived this “heavy presumption” explicitly. *See, e.g., Plantronics*, 724 F.3d at 1350; *Starhome*, 743 F.3d at 857. Courts should be wary of this revival, as it appears to conflict with the methodology approved en banc by *Phillips*.

5.4.1.2 “Presumption in Favor of Dictionary Definition” No Longer Applies

Texas Digital also created a “presumption in favor of a dictionary definition,” and held that dictionaries and other such outside sources should be consulted *before* interpreting the patent specification. *Phillips* overruled that approach. *See* § 5.2.3.2.2.1. The court rejected *Texas Digital*’s undue emphasis on dictionaries as a source of ordinary meaning. *Phillips* does not offer a single formula for claim con-

10. The last time the Federal Circuit cited this standard prior to *Phillips* was in *Fuji Photo Film Co., Ltd. v. Int’l Trade Comm’n*, 386 F.3d 1095, 1105 (Fed. Cir. 2004). This standard remained absent from Federal Circuit case law until it was cited in *Elbex Video, Ltd. v. Sensormatic Elecs. Corp.*, 508 F.3d 1366, 1371 (Fed. Cir. 2007). This reference appears to be an outlier. There is no indication that the Federal Circuit intended to resuscitate the “heavy presumption” in favor of dictionary meaning.

struction, but broadly instructs that claims must be interpreted consistent with a “full understanding of what the inventors actually invented and intended to envelop with the claim,” and that the construction that “stays true to the claim language and most naturally aligns with the patent’s description of the invention will be, in the end, the correct construction.” *Phillips*, 415 F.3d at 1316. Thus, there is a renewed emphasis on construing claim terms consistent with their usage in the specification.

5.4.1.3 Reliance on Extrinsic Evidence Is Permissible but Cannot Override Intrinsic Evidence

District courts are still reluctant to consider extrinsic evidence, based on *Vitronics*, 90 F.3d at 1583 (Fed. Cir. 1996). That case discouraged trial courts from relying on extrinsic evidence where the intrinsic evidence was sufficiently clear to resolve the claim-construction dispute. *Id.* (“In most situations, an analysis of the intrinsic evidence alone will resolve any ambiguity in a disputed claim term. In such circumstances, it is improper to rely on extrinsic evidence.”). *Vitronics* has been interpreted, widely and incorrectly, as a prohibition on extrinsic evidence. The Federal Circuit has consistently backed away from that interpretation, and now *Teva* removes any doubt that extrinsic evidence may be considered during claim construction. It is important to bear in mind, however, that extrinsic evidence cannot be relied upon to override contrary meaning reflected in the specification or other intrinsic evidence. See *Phillips*, 415 F.3d at 1317–18 (noting that extrinsic evidence is “less significant than the intrinsic record” and “less reliable” than intrinsic evidence).

5.4.2 Checklist/Discussion Points for Claim-Construction Hearing

The following summary list reflects key principles for the procedural and substantive elements of *Markman* law.

5.4.2.1 Procedural Aspects

- *Markman Timing*—Recommended approach is to allow sufficient pre-*Markman* discovery and allow identification of claim-construction issues, but sufficient time post-*Markman* to allow *Markman* opinion to issue prior to expert reports.
- *Crystallizing Issues for Markman Hearing*—Courts should order a structured meet-and-confer process in advance of briefing to avoid false disputes and ensure that genuine disputes are properly joined. Courts should use their discretion to prioritize the timing of (and possibly need for) construction of particular claim terms.
- *Consideration of Extrinsic Evidence*—Courts are free to consider extrinsic evidence in support of their *Markman* rulings, but it may not contradict the intrinsic evidence.

- *Fact-Finding*—Courts should ask the parties how the *Markman* hearings should be structured to allow for an evidentiary hearing, if necessary, to build a factual record to allow for deferential review on appeal.

5.4.2.2 Substantive Aspects

- *Threshold Analysis*—Carefully assess what terms require interpretation and what deference, if any, to accord *Markman* rulings of the same patents and claim terms in prior cases.
- *Ordinary Meaning*—The “ordinary meaning” of a claim term is the baseline for claim construction, but there is no longer a “heavy presumption” that it applies. Rather, it is appropriate to depart from the “ordinary” meaning where the intrinsic evidence persuasively demonstrates “what the inventors actually invented and intended to envelop with the claim.” *Phillips*, 415 F.3d at 1316.
- *Dictionaries*—There is no “presumption in favor of a dictionary definition.” Rather, the proper construction comes foremost from a context-dependent review of the patent and its prosecution history.
- *Departing from Ordinary Meaning*—It may be appropriate to construe a claim term differently than its ordinary meaning when the specification and prosecution history provide reasonable clarity of what the inventors actually intended to claim, including by characterizing the “present invention” to emphasize a particular feature, or distinguishing the prior art in a manner to highlight what the inventors viewed as their invention, or giving a consistent and uniform meaning to terms throughout the patent, among other scenarios.

Appendix 5.1 Joint Claim-Construction Statement Order

UNITED STATES DISTRICT COURT
DISTRICT OF _____

COMPANY A,

Plaintiff,

v.

COMPANY B,

Defendant.

Civil Case No. [CASE NO.]

ORDER

Date: [DATE]

_____, **District Judge:**

The Court hereby orders the parties to file their joint claim construction statement [pursuant to Local Patent Rule ____] by [DATE] and provide the following joint multi-claim chart: Column 1 shall be the claim term to be construed, in rank-order of importance from the most significant to the least significant.

1. Column 2 shall be Plaintiff's proposed construction of the term.
2. Column 3 shall state the impact of Plaintiff's proposed construction of the term on validity or infringement, and whether such construction is case dispositive.
3. Column 4 shall be Defendant's proposed construction of the term.
4. Column 5 shall state the impact of Defendant's proposed construction of the term on validity or infringement, and whether such construction is case dispositive.

IT IS SO ORDERED.

Appendix 5.2 Sample Joint Claim-Construction Charts

**UNITED STATES DISTRICT COURT
FOR THE DISTRICT OF NEW JERSEY**

IBORMEITH IP, LLC.,	:	Civil Action No. 2:10-CV-05378-FSH-PS
	:	
Plaintiff,	:	
	:	JOINT CLAIM CONSTRUCTION AND
v.	:	PREHEARING STATEMENT
	:	
MERCEDES-BENZ USA,	:	
LLC and DAIMLER AG,	:	
	:	
Defendants.	:	
	:	
	:	

Plaintiff Ibormeith and Defendants Mercedes-Benz USA, LLC and Daimler AG respectfully submit the following Joint Claim construction and Prehearing Statement. A chart identifying all terms requiring construction and the parties' supporting evidence is attached hereto.

A. LOCAL PATENT RULE 4.3(a) – CONSTRUCTION OF CLAIM TERMS UPON WHICH THE PARTIES AGREE

The parties agree on the construction of the 11th term previously identified as requiring construction. The parties will continue working together to narrow the number of disputed claim terms.

Term No.	Term to be Construed	Plaintiff's Construction	Defendants' Construction
11. (11th claim in chart)	warning indicator (Claim 1)	an audio and/or visual indication of sleepiness provided to the driver	Agree with plaintiff's construction

B. LOCAL PATENT RULE 4.3(b) – PROPOSED CONSTRUCTION OF DISPUTED CLAIM TERMS

Term No.	Term to be Construed	Plaintiff’s Construction	Defendants’ Construction
1	a sensor for sensing a driver or operator control input (Claim 1)	Plaintiff contends that this is <u>not</u> a means-plus-function clause under Section 112, ¶6. Interpretation: A device that converts a driver’s control input to an electrical signal supplying data about the control input.	Defendants contend that this clause is governed by § 112 ¶ 6 and accordingly identify the following structure(s) in the specification which correspond to the function “sensing a driver or operator control input” (which includes hardware and software, and thus also the algorithms used by the software): accelerometer, steering wheel movement sensor, transmission drive shaft sensor, accelerator movement sensor, software and associated algorithms, and equivalents under 112 ¶ 6.
2	control input (Claim 1)	interaction between a driver and the vehicle’s controls	“a command from the driver to the vehicle’s controls”
3	operational model (Claim 1)	computer software that includes a physiological reference model of driver circadian rhythm pattern(s) and a vehicle operating model or algorithm	Defendants contend that this clause is invalid under § 112 ¶ 2 as indefinite. Alternatively, it shall be construed as: Defendants contend that this clause is governed by § 112 ¶ 6 and accordingly identify the following structure(s) in the specification which correspond to the operating function covering the structure of: processor, computer software, memory, and associated algorithms containing a physiological reference model of driver circadian rhythm patterns and a vehicle operating model or algorithm, as disclosed in the specification and equivalents thereof under 112 ¶ 6.
4	physiological reference model (of driver circadian rhythm pattern(s)) (Claim 1)	data that is based on one or more circadian rhythm patterns that relate to a driver’s predisposition to sleepiness	“electronic data regarding those circadian processes of the specific vehicle driver which relate to sleep”
5	circadian rhythm pattern(s) (Claims 1 and 9)	A regular pattern in which the normal human body’s biological or physiological activity varies with the time of day, over a 24-hour cycle. Also known as a biorhythm or body clock.	“physiological processes of the human driver or operator which vary with the time of day and occur in approximately 24-hour periods or cycles”

Term No.	Term to be Construed	Plaintiff's Construction	Defendants' Construction
6	operating model or algorithm (Claim 1)	software for computing a decision to provide a warning indication of driver sleepiness	<p>Defendants contend that this clause is invalid under § 112 ¶ 2 as indefinite. Alternatively, it shall be construed as:</p> <p>Defendants contend that this clause is governed by § 112 ¶ 6 and accordingly identify the following structure(s) in the specification which correspond to the function of "operating" including one or more of: processor, memory, software, and associated algorithms as disclosed in one or more of Claim 1; Figs. 4-9; Fig. 21; Tables 8-15, 18, 20, and 24; col. 4, Lines 4-10; col. 8, Lines 29-33; col. 9, Lines 6-16, and equivalents thereof under 112 ¶ 6.</p>
7	computational means for weighting the operational model according to time of day in relation to the driver or operator circadian rhythm pattern(s) and for deriving, from the weighted model, driver or operator sleepiness condition and producing an output determined thereby (Claim 1)	<p>Construction Under Section 112, ¶6</p> <p>Function: "weighting the operational model according to time of day in relation to the driver or operator circadian rhythm pattern(s)" and "deriving, from the weighted model, driver or operator sleepiness condition and producing an output determined thereby." Structure: processor(s) programmed with software to perform a software algorithm that includes the following steps: obtaining a value of driver predisposition to sleepiness based on the current time of day (in relation to circadian rhythm patterns); obtaining data from one or more sensory or driver inputs; applying weighting factors to the sensory inputs; calculating an adjusted value of driver predisposition to sleepiness; applying the adjusted value to one or more warning threshold values; and outputting a signal if one or more of the thresholds is exceeded; and all equivalents thereof.</p>	<p>Defendants contend that this clause is invalid under § 112 ¶ 2 as indefinite for not providing the specific algorithm(s) associated with the software. Alternatively, it shall be construed as: Function: "weighting the operational model according to time of day in relation to the driver or operator circadian rhythm pattern(s)" and "deriving, from the weighted model, driver or operator sleepiness condition and producing an output determined thereby."</p> <p>Defendants contend that this clause is governed by § 112 ¶ 6 and accordingly identify the following structure(s) in the specification which correspond to the computational means which must include the computer, memory, microprocessor programmed with software, and associated algorithm(s), as disclosed in one or more of the following:</p> <p>Figs. 1, 3-9, 15A-D, 16A-B, 17, 20 and 21; Tables 10-15, 18, 20, and 24; col. 2, Lines 43-47; col. 3, Lines 21-24; col. 3, Lines 39-42; col. 3, Lines 43-49; col. 4, Lines 50-58; col. 5, Lines 3-5; col. 6, Lines 37-39; col. 7, Lines, 62-67; col. 8, Lines 14-17; col. 9, Lines 60-64, and equivalents thereto under 112 ¶ 6.</p>

Term No.	Term to be Construed	Plaintiff's Construction	Defendants' Construction
8	weighting (Claim 1)	Taking into account the relative significance of a factor in a computation	“assigning a quantitative value for the purpose of establishing the relative importance or magnitude of a factor in a computation”
9	weighted model (Claim 1)	refers to the same software used to perform the function of “weighting the operational model according to time of day,” which is being interpreted in #7 above; no separate construction is required	No alternative construction is required so long as the “weighted model” refers to the weighted “operational model”
10	sleepiness condition (Claim 1)	a driver's condition or state of sleepiness, drowsiness or lack of alertness	“The state or condition of drowsiness or sleepiness of an individual driver”
12	a sensor for sensing a steering movement, about a reference position (Claim 9)	plaintiff contends that this is <u>not</u> a means-plus-function clause under Section 112, ¶6. Interpretation: A device that converts a driver's movement of the steering wheel to an electrical signal supplying data about the movement of the steering wheel.	Defendants contend that this clause is governed by § 112 ¶ 6 and accordingly identify the following structure(s) in the specification which correspond to the function of sensing a steering movement about a reference position: steering wheel movement sensor as disclosed in Figs. 20 and 21; Tables 1, 2, and 9; col. 8, Lines 41–43, software and associated algorithms, and equivalents under 112 ¶ 6.
13	time of day physiological reference profile (Claim 9)	data that is based on a human's predisposition to sleepiness depending on time of day	“electronic information about those physiological and circadian processes of the vehicle driver which relate to sleep and which occur in approximately 24-hour periods or cycles”
14	predisposition to sleepiness (Claim 9)	tendency or susceptibility to sleepiness, drowsiness or lack of alertness	“an inclination towards drowsiness or sleepiness resulting from the driver or operator's natural circadian rhythm pattern”

Chapter 5: Claim Construction

Term No.	Term to be Construed	Plaintiff's Construction	Defendants' Construction
15	computational means for computing steering transitions and weighing that computation according to time of day, to provide a warning indication of driver sleepiness. (Claim 9)	<p>Construction under Section 112, ¶6</p> <p>Function: "computing steering transitions and weighing that computation according to time of day."</p> <p>Structure: processor(s) programmed with software to perform a software algorithm that includes the following steps: using data from the steering movement sensor, determining the frequency of a driver's steering movements (changes in steering angle) and determining a value for any deficit from the expected frequency of an alert driver's steering movements;</p> <p>determining the amplitude of a driver's steering movements (extent of change in steering angle) and determining a value for any surfeit from the expected amplitude of an alert driver's steering movements;</p> <p>obtaining a value of driver predisposition to sleepiness based on the current time of day;</p> <p>calculating a value of driver predisposition to sleepiness taking into account the above values;</p> <p>applying one or more warning threshold values;</p> <p>and outputting a signal if one or more of the thresholds is exceeded to trigger a warning;</p> <p>and all equivalents thereof.</p>	<p>Defendants contend that this clause is invalid under § 112 ¶ 2 as indefinite for not providing the specific algorithm associated with the software.</p> <p>Alternatively, it shall be construed as:</p> <p>Function: "computing steering transitions" and "weighing that computation according to time of day"</p> <p>Defendants contend that this clause is governed by § 112 ¶ 6 and accordingly identify the following structure(s) in the specification which correspond to the computational means which must include the computer, memory, micro-processor programmed with software, and associated algorithms, as disclosed in one or more of the following: Figs. 1, 3-9, 15A-D, 16A-B, 17, 20, and 21; Tables 10-15, 18, 20, and 24; col. 2, Lines 43-47; col. 3, Lines 13-14; col. 3, Lines 39-42; col. 3, Lines 50-53; col. 3, Line 66; col. 4, Line 3; col. 8, Lines 10-17; col. 8, Lines 41-43; col. 9, Lines 60-64, and equivalents</p>
16	steering transitions (Claim 9)	changes in steering wheel angle	<p>This term renders the claim invalid for indefiniteness under § 112 ¶ 2.</p> <p>If the Court sees fit to construe this term, it should mean:</p> <p>"changes in the angular position of the steering wheel of a vehicle that result in a zero crossing"</p>
17	weighing (Claim 9)	taking into account a factor in a computation	"Assigning a quantitative value for the purpose of establishing relative magnitude or importance"

C. LOCAL PATENT RULE 4.3(c) – SIGNIFICANT OR DISPOSITIVE CLAIM TERMS

In accordance with Local Patent Rule 4.3(c), the parties do not believe that any of the disputed claim terms will be case or claim dispositive, or substantially conducive to promoting settlement.

D. LOCAL PATENT RULE 4.3(d) – ANTICIPATED TIME NEEDED FOR CLAIM CONSTRUCTION HEARING

In accordance with Local Patent Rule 4.3(d), the parties agree and respectfully request that the claim construction hearing consist of attorney argument. At this time the parties do not expect to call any expert witnesses for live testimony at the claim construction hearing. The parties estimate that the claim construction hearing will require approximately 3 hours of attorney argument, with 90 minutes allotted to each side.

E. LOCAL PATENT RULE 4.3(e) – IDENTIFICATION OF ANTICIPATED WITNESSES FOR CLAIM CONSTRUCTION HEARING

In accordance with Local Patent Rule 4.3(e), the parties do not anticipate calling any witness in support of the parties' respective claim construction arguments.

Respectfully
submitted,

[Attorneys for Plaintiff]

[Attorneys for Defendants]

Dated: _____

IN THE UNITED STATES DISTRICT COURT
FOR THE DISTRICT OF NEW JERSEY

IBORMEITH IP, LLC,	
Plaintiff,	Civil Action No. 10-CV-05378 (FSH)
v.	
MERCEDES-BENZ USA, LLC, and DAIMLER AG,	SUPPLEMENTAL JOINT CLAIM CONSTRUCTION STATEMENT
Defendants.	

Plaintiff Ibormeith and Defendants Mercedes-Benz USA, LLC and Daimler AG respectfully submit the following Supplemental Joint Claim Construction and Prehearing Statement, pursuant to the Court's instructions during the March 26, 2012 telephonic status conference. This document supplements and amends the Original Statement, Docket No. 45-1, dated September 15, 2011.

A. LOCAL PATENT RULE 4.3(a) - CONSTRUCTION OF CLAIM TERMS UPON WHICH THE PARTIES AGREE

The parties continue to agree on the construction of the 11th term originally identified as requiring construction.

Term No.	Term to be Construed	Agreed Construction
11	warning indicator (Claim 1)	an audio and/or visual indication of sleepiness provided to the driver

B. LOCAL PATENT RULES 4.3(b) AND (c) - REVISED LIST OF CLAIM TERMS REQUIRING CONSTRUCTION

Pursuant to the Court's instructions during the March 26, 2012 telephonic status conference, the parties in the above-captioned matter have met-and-conferred to reduce the number of claim terms from U.S. Patent No. 6,313,749 (the '749 patent) requiring construction.

Without waiving any rights, the parties have agreed to remove from the disputed list eleven terms, specifically Term Nos. 1, 2, 4, 5, 8, 9, 10, 12, 13, 14 and 17, from the list in Docket 45-1. The following revised list contains the five remaining disputed terms, Term Nos. 3, 6, 7, 15, and 16 from the original filing. As requested, the parties have attached as Exhibit 1 a chart that lists the terms in order of significance. The revised chart adds the right column, which contains a brief statement of the significance of those terms. Defendants also added text to the column providing their proposed constructions of Term Nos. 7 and 15, which Defendants contend is based on the specification sections cited in the original construction. Plaintiff objects to the additions to Defendants' proposed constructions.

Dated: April 11, 2012

[Attorneys for Plaintiff]

[Attorneys for Defendants]

NO.	TERM FOR CONSTRUCTION	PLAINTIFF'S CONSTRUCTION	DEFENDANT'S CONSTRUCTION	SIGNIFICANCE
7	<p>Claim 1: “computational means for weighting the operational model according to time of day in relation to the driver or operator circadian rhythm pattern(s) and for deriving, from the weighted model, driver or operator sleepiness condition and producing an output determined thereby”</p>	<p>Construction Under Section 112, ¶ 6</p> <p><u>Function</u>: “weighting the operational model according to time of day in relation to the driver or operator circadian rhythm pattern(s)” and “deriving, from the weighted model, driver or operator sleepiness condition and producing an output determined thereby.”</p> <p><u>Structure</u>: processor(s) programmed with software to perform a software algorithm that includes the following steps:</p> <p>obtaining a value of driver predisposition to sleepiness based on the current time of day (in relation to circadian rhythm patterns); obtaining data from one or more sensory or driver inputs;</p> <p>applying weighting factors to the sensory inputs; calculating an adjusted value of driver predisposition to sleepiness;</p> <p>applying the adjusted value to one or more warning threshold values; and outputting a signal if one or more of the thresholds is exceeded; and all equivalents thereof</p>	<p>Defendants contend that this clause is invalid under § 112 ¶ 2 as indefinite for not providing the specific algorithm(s) associated with the software.</p> <p>Alternatively, it shall be construed under § 112 ¶ 6 as:</p> <p><u>Function</u>: “weighting the operational model according to time of day in relation to the drive or operator circadian rhythm pattern(s)” and “deriving, from the weighted model, driver or operator sleepiness condition and producing an output determined thereby.”</p> <p><u>Structure</u>: computer, memory, microprocessor programmed with software, and the associated algorithms disclosed in the following locations in the specification and equivalents thereto: Figs. 1, 3-9, 15-21; Tables 1-16, 18-24; col. 2, Lines 43-47; col. 3, Lines 21-24, 39-49; col. 4, Lines 50-58; col. 5, Lines 3-5; col. 7, Lines 17-67; col. 8, Lines 1-9, 14-17; col. 9, lines 60-64.</p> <p>The specific algorithms partially disclosed in the cited portions of the specification being:</p> <p><u>Algorithm A</u></p> <p>1) Obtain from Figure 3 a circadian score (“S circ”) reflecting the driver’s predisposition to sleepiness based on the time-of-day;</p>	<p>The “computational means” of claims 1 and 9 require construction as “means-plus-function” limitations under 35 U.S.C. § 112 ¶ 6.</p> <p>These limitations present the greatest level of complexity</p> <p>Defendants’ contention that the clause is indefinite would, if adopted, invalidate claim 1.</p> <p>Defendants also believe that adoption of their alternate construction would support a motion for summary judgment of noninfringement of claim 1, but Plaintiff disagrees.</p>

NO.	TERM FOR CONSTRUCTION	PLAINTIFF'S CONSTRUCTION	DEFENDANT'S CONSTRUCTION	SIGNIFICANCE
			<p>2) Adjust the circadian score upward or downward -through addition or subtraction - to account for values reflecting: (i) the age of the driver; (ii) the sex of the driver; (iii) the amount of sleep the driver has had; and (iv) the temperature of the vehicle;</p> <p>3) If the cumulative score is greater than or equal to "3," use a steering sensor to assess the condition of the road (monotonous or not) and adjust the cumulative score, up or down, accordingly; [Note: the specification does not disclose for Algorithm A how to determine whether a road is monotonous.]</p> <p>4) Compare the weighted score to the "sleepiness warning thresholds" from Figure 17;</p> <p>5) If the score exceeds the thresholds, issue a sleepiness warning to the driver.</p> <p>Algorithm B</p> <p>1) Obtain a circadian score ("S circ") of between 0 and 1 that reflects a driver's baseline predisposition to sleepiness in relation to the time of day; [Note: the specification does not disclose the method of scaling "S circ" between 0 and 1]</p> <p>2) Increase (but never decrease) the circadian score by adding a value of between 0 and 1 to</p>	

NO.	TERM FOR CONSTRUCTION	PLAINTIFF'S CONSTRUCTION	DEFENDANT'S CONSTRUCTION	SIGNIFICANCE
			<p>account for the seven factors associated with sleepiness reflected in Table 10: (i) ambient light; (ii) vehicle temperature; (iii) sleep history; (iv) the duration of the trip; (v) the presence of excessive amplitude in corrective steering movements; (vi) the absence of certain corrective steering movements; and (vii) deviation from expected vehicle acceleration and deceleration activity. The weighted score must be between 0 and 1. [Note: the specification does not disclose the relative importance or value of the sleepiness factors]</p> <p>3) Compare the weighted score to one or more predetermined warning thresholds; [Note: no thresholds are provided in the specification]</p> <p>4) Issue a sleepiness warning to the driver if the weighted score exceeds one or more predetermined thresholds and the driver has been operating the vehicle for more than a predetermined period of time. [Note: the specification does not disclose the predetermined period of time]</p>	

<p>15</p>	<p>Claim 9: “computational means for computing steering transitions and weighting that computation according to time of day, to provide a warning indication of driver sleepiness”</p>	<p>Construction under Section 112, ¶ 6 <u>Function</u>: “computing steering transitions and weighting that computation according to time of day.” <u>Structure</u>: processor(s) programmed with software algorithm that includes the following steps: using data from the steering movement sensor, determining the frequency of a driver’s steering movements (Changes in steering angle) and determining a value for any deficit from the expected frequency of an alert driver’s steering movements; determining the amplitude of a driver’s steering movements (extent of change in steering angle) and determining a value for any surfeit from the expected amplitude of an alert driver’s steering movements; obtaining a value of driver predisposition to sleepiness based on the current time of day; calculating a value of driver predisposition to sleepiness taking into account the above values; applying one or more warning threshold values; and outputting a signal if one or more of the thresholds is exceeded to trigger a warning; and all equivalents thereof.</p>	<p>Defendants contend that this clause is invalid under §112 ¶ 2 as indefinite for not providing the specific algorithm associated with the software. Alternatively, it shall be construed under §112 ¶ 6 as: <u>Function</u>: “computing steering transitions” and “weighting that computation according to time of day” <u>Structure</u>: computer, memory, microprocessor programmed with software, and the associated algorithms disclosed in the following locations in the specification, and equivalents thereto: Figures 1, 3–9, 15A–D, 17, 18, 19, 20, 21; Tables 1–4, 6–16, 18–20, 22–24; col. 2, Lines 43–47; col. 3, Lines 13–14; col. 39–42; col. 3, Lines 50–53; col. 3, Line 66 to col. 4, Line 3; col. 4, Lines 50–58; col. 5, Lines 3–5; col. 8, Lines 10–17; col. 8, Lines 35 to col. 9, Line 19; col. 9, Lines 60–64. The specific algorithms partially disclosed in the cited portions of the specification being: Algorithm C 1) Establish a reference value reflecting the number of times an alert driver turns the steering wheel across the straight-ahead position (“zero crossings”); 2) Establish a reference value reflecting a measure of the amplitude over time of steering movements by an alert driver;</p>	<p>The “computational means” of claims 1 and 9 require construction as “means plus-function” limitations under 35 U.S.C. §112 ¶ 6. These limitations present the greatest level of complexity. Defendants’ contention that the clause is indefinite would, if adopted, invalidate claim 9. Defendants also believe that adoption of their alternate construction would support a motion for summary judgment of noninfringement of claim 9, but Plaintiff disagrees.</p>
-----------	--	--	--	---

		<p>3) Set the straight-ahead steering position as a reference position;</p> <p>4) Using a steering sensor, calculate a current number of zero crossings over a period of time; [Note: <i>the specification does not disclose the period of time</i>]</p> <p>5) Using a steering sensor, calculate a measure of the current amplitude of steering movements over a period of time; [Note: <i>the specification does not disclose the period of time</i>]</p> <p>6) Compare the number of current zero crossings to the reference value;</p> <p>7) Compare the current measure of amplitude of steering movements to the reference value;</p> <p>8) Compare current variability in the amplitude of steering movements to the referenced value;</p> <p>9) Issue a sleepiness warning if two of the following three conditions occur:</p> <ul style="list-style-type: none"> (i) the current number of zero crossings is “fewer” than the reference value; (ii) the current measure of amplitude steering movements is “larger” than the reference value; (iii) the current variability in the measure of amplitude is “more” than the reference value. <p>[Note: <i>claim 9 requires weighting according to time of day, but the specification does not disclose a method for performing such weighting in Algorithm C</i>]</p>	
--	--	--	--

		<p>Algorithm D</p> <ol style="list-style-type: none"> 1) Establish a reference value reflecting the number of times the specific driver, when alert, turns the steering wheel across a dynamic reference position (“zero crossings”); 2) Establish a reference value reflecting a measure of the amplitude of steering movements over time by the specific driver; 3) Establish a dynamic reference position, called “ZeroWheel,” according to formula in Table 7; 4) Calculate the current number of times the steering wheel crosses the “Zero Wheel” position during a period of time; 5) Calculate the current measure of the amplitude of the steering movements in relation to the “Zero Wheel” position over a period of time; 6) Calculate the difference between the current number of zero crossings and the reference value to determine the deficit, if any, in current zero crossings; 7) Calculate the difference between the current measure of amplitude of steering movements and the reference value to determine the excess (“surfeit”), if any, in the current measure of amplitude; 8) Weight the results of steps (6) and (7) according to the formulas for “S zerox” and “S rms” in Table 10; 	
--	--	---	--

Chapter 5: Claim Construction

			<p>9) Add the values of “S zerox” and “S rms” to a circadian score (“S circ”) of between 0 and 1, which circadian score is based on the time of day; [Note: the specification does not disclose the method of scaling “S circ” between 0 and 1]</p> <p>10) Issue a sleepiness warning to the driver if the sum of step (9) exceeds one or more predetermined thresholds and the driver has been operating the vehicle for more than a predetermined period of time. [note: no thresholds are provided in the specification]</p>	
16	Claim 9: “steering transitions”	Changes in steering wheel angle	<p>This term renders the claim invalid for indefiniteness under § 112 ¶2. If the Court sees fit to construe this term, it should mean: “changes in the angular position of the steering wheel of a vehicle that result in a zero crossing”</p>	<p>Defendants’ contention that the clause is indefinite would, if adopted, invalidate claim 9. Defendants also believe that adoption of their alternate construction would support a motion for summary judgment of noninfringement of claim 9, but Plaintiff disagrees.</p>
6	Claim 1: “a vehicle or machine operating model or algorithm”	Software for computing a decision to provide a warning indication of driver sleepiness	<p>Defendants contend that this clause is invalid under § 112 ¶2 as indefinite. Alternatively, it shall be construed as: Defendants contend that this clause is invalid under § 112 ¶6 and accordingly identify the following structure(s) in the specification which correspond to the function of “operating” including one or more of: processor, memory, software, and associated algorithms as disclosed in one or more of</p>	<p>Defendants’ contention that the clause is indefinite would, if adopted, invalidate claim 1. Defendants also believe that adoption of their alternate construction would support a motion for summary judgment of noninfringement</p>

3	Claim 1: “operational model”	computer software that includes a physiological reference model of driver circadian rhythm pattern(s) and a vehicle operating model or algorithm	Claim 1; Figs. 4–9; Fig. 21; Tables 8–15, 18, 20, and 24; col. 4, Lines 4–10; col. 8, Lines 29–33; col. 9, Lines 6–16, and equivalents thereof under § 112 ¶6. Defendants contend that this clause is invalid under § 112 ¶2 as indefinite. Alternatively, it shall be construed as: Defendants contend that this clause is Governed by § 112 ¶6 and accordingly identify the following structure(s) in the specification which correspond to the operating function covering the structure of: processor, computer software, memory, and associated algorithms containing a physiological reference model of driver circadian rhythm patterns and a vehicle operating model or algorithm, as disclosed in the specification and equivalents thereof under § 112 ¶6.	of claim 1, but Plaintiff disagrees.
				Defendants’ contention that the clause is indefinite would, if adopted, invalidate claim 1. Defendants also believe that adoption of their alternate construction would support a motion for summary judgment of noninfringement of claim 1, but Plaintiff disagrees.

Chapter 6

Summary Judgment

- 6.1 Managing the Summary Judgment Process 2
 - 6.1.1 Distinguishing Questions of Law from Questions of Fact 2
 - 6.1.2 Summary Judgment and Claim Construction 9
 - 6.1.3 Recommended Dual-Track Approach to Summary Judgment 10
 - 6.1.3.1 “First-Track” Summary Judgment Motions 11
 - 6.1.3.2 “Second-Track” Summary Judgment Motions 12
 - 6.1.3.3 Implementing a Dual-Track Approach to Summary Judgment 13
 - 6.1.3.4 Recognizing First-Track Summary Judgment Motions 14
 - 6.1.3.4.1 Noninfringement and Divided Infringement 14
 - 6.1.3.4.2 Invalidity Challenges Under § 112 15
 - 6.1.3.4.3 Invalidity Challenges Under §§ 102 and 103 16
 - 6.1.3.4.4 Invalidity Challenges Under § 101 17
 - 6.1.4 Summary Judgment Independent from Claim Construction (Off-Track) 20
 - 6.1.5 Streamlining the Summary Judgment Process 21
 - 6.1.5.1 Recommended Approach: Letter Briefs Followed by Summary Judgment Motions 22
 - 6.1.5.2 Limiting the Number of Summary Judgment Motions or the Number of Pages of Summary Judgment Briefing 22
 - 6.1.5.3 Multiple Rounds of Summary Judgment Hearings 23
 - 6.1.6 The Summary Judgment Hearing 24
 - 6.1.6.1 Length and Division of Time 25
 - 6.1.6.2 Live Testimony 25
 - 6.1.6.3 Graphics 25
 - 6.1.6.4 Technology Tutorial 25
 - 6.1.7 Expert Declarations Filed in Connection with Summary Judgment Motions 26
 - 6.1.7.1 Some Expert Testimony Cannot Defeat Summary Judgment 26
 - 6.1.7.1.1 Testimony About Conclusions of Law 26
 - 6.1.7.1.2 Conclusory Testimony 26
 - 6.1.7.1.3 Testimony Contradicting Clear Disclosure of Prior Art 26
 - 6.1.7.1.4 Testimony Contradicting Admissions of a Party 27
 - 6.1.7.2 Legal Insufficiency of Expert Testimony 27
 - 6.1.7.3 Expert Testimony Beyond the Scope of the Expert Report 27
 - 6.1.8 Narrowing Trial Issues Through Federal Rule of Civil Procedure 56(g) 29
- 6.2 Substantive Issues Commonly Raised During Summary Judgment 29
 - 6.2.1 Issues More Amenable to Summary Judgment 30
 - 6.2.1.1 Validity 30
 - 6.2.1.1.1 Patentable Subject Matter 30
 - 6.2.1.1.2 Obviousness 32
 - 6.2.1.1.3 Anticipation 35
 - 6.2.1.1.4 Section 112(f) Indefiniteness 35
 - 6.2.1.1.5 Section 112(b) Indefiniteness Under *Nautilus* 36
 - 6.2.1.2 Infringement 38
 - 6.2.1.2.1 Absence of Literal Infringement 38
 - 6.2.1.2.2 Whether Infringement Under the Doctrine of Equivalents Is Barred by *Festo* 38
 - 6.2.1.2.3 Whether Infringement Under the Doctrine of Equivalents Would Violate the *Wilson Sporting Goods* Doctrine 39
 - 6.2.1.2.4 The Actions Accused of Infringement Did/Did Not Occur Within the United States 39
 - 6.2.1.2.5 The Absence of Evidence of Direct Infringement Bars Claims of Indirect Infringement 40

6.2.1.2.6	“Divided” (Joint) Infringement: The Actions Accused of Infringement Are Made by Multiple Parties, Not Just the Accused Infringer	40
6.2.1.2.7	Absence of Evidence Showing the Required Mental State for Indirect Infringement	41
6.2.1.2.8	License and Exhaustion Defenses	42
6.2.1.3	Damages	42
6.2.2	Issues Less Amenable to Summary Judgment	43
Appendix 6.1	Sample Standing Order Setting a Schedule for First-Track Summary Judgment Motions	47

Effective utilization of the summary judgment process is especially important in patent cases because such cases present so many complex issues. Summary judgment can play a critical role in narrowing or simplifying the issues, thereby promoting settlement or simplifying the trial. On the other hand, the summary judgment process in a patent case can put a significant burden on the court, particularly if the parties file numerous, voluminous motions.

The first part of this chapter discusses areas in which courts can promote efficiency in the summary judgment process, and recommends approaches courts have found effective. It also discusses the types of motions that are more and less suited to resolution via summary judgment. The second part of this chapter discusses various substantive issues that often arise during the summary judgment process in patent cases.

6.1 Managing the Summary Judgment Process

In general, effective management of the summary judgment process in patent cases requires an understanding of the types of issues that drive most patent cases and how they typically unfold over the life of a case. It also requires the court to be assertive in case management.

As with any case, the timing of summary judgment motions can be critical. If summary judgment proceedings are held too early for a given case, questions of fact that would have been resolved at a later stage preclude summary judgment. However, deferring summary judgment too long risks wasting the time and resources of the parties and the court on issues that limited discovery could have resolved.

6.1.1 Distinguishing Questions of Law from Questions of Fact

The court “shall grant summary judgment if the movant shows that there is no genuine dispute as to any material fact and the movant is entitled to judgment as a matter of law.” Fed. R. Civ. P. 56(a). Thus, pure questions of law, mixed questions of law and fact on which there is no genuine dispute as to any material fact, and undisputed questions of fact are amenable to summary adjudication. *See generally* Gary M. Hnath & Timothy A. Molino, *The Roles of Judges and Juries in Patent Litigation*, 19 Fed. Cir. B.J. 15 (2009–2010); Kevin Casey, Jade Camara, & Nancy Wright, *Standards of Appellate Review in the Federal Circuit: Substance and Semantics*, 11 Fed. Cir. B.J. 279 (2001–2002).

These distinctions are especially subtle in patent litigation, reflecting the complex interplay of fact and law. Furthermore, even though the ultimate claim construction determination is a question of law potentially based on subsidiary questions of fact, *Teva Pharmaceuticals USA, Inc. v. Sandoz, Inc.*, 135 S. Ct. 831 (2015), the subsidiary facts are within the province of the court, *Markman v. Westview Instruments, Inc.*, 517 U.S. 370 (1996), thereby expanding the range of issues that can be resolved on summary judgment. See J. Jonas Anderson & Peter S. Menell, *Restoring the Fact/Law Distinction in Patent Claim Construction*, 109 Nw. U. L. Rev. Online 187 (2015).

Table 6.1, Table 6.2, Table 6.3, and Table 6.4 summarize the characterization of patent issues as questions of law, questions of fact, questions of law that are based on underlying questions of fact, and unresolved characterizations. Among the most salient, yet unresolved, fact/law issues is patentable subject matter (§ 101). This area had lain dormant, but has been revived by four recent Supreme Court decisions—*Bilski*, *Mayo*, *Myriad*, and *Alice*. See § 14.3.1. While providing conceptual frameworks, these decisions do not provide clear guidance on managing the resolution of patentable subject matter disputes. In particular, it is unclear whether Step 2 of the *Mayo/Alice* framework—whether the claim contains an inventive concept sufficient to transform the ineligible law of nature, natural, phenomena, or abstract idea into a patent-eligible application of the ineligible subject (or, alternatively, whether the application is merely routine or conventional)—turns on factual underpinnings.

Table 6.1
Patent Issues—Questions of Law

Doctrine	Authority
Claim Construction of § 112(f) Claims	<i>Cardiac Pacemakers, Inc. v. Saint Jude Med., Inc.</i> , 296 F.3d 1106, 1113 (Fed. Cir. 2002) (means plus function claims); <i>Linear Tech. Corp. v. Impala Linear Corp.</i> , 379 F.3d 1311, 1318 (Fed. Cir. 2004) (determining whether a claim language should be interpreted as a mean plus function limitation)
Implied License	<i>Monsanto Co. v. Scruggs</i> , 459 F.3d 1328, 1336 (Fed. Cir. 2006)
Repair or Reconstruction	<i>Fuji Photo Film Co. v. Int’l Trade Comm’n</i> , 474 F.3d 1281, 1289 (Fed. Cir. 2007)

Doctrines	Authority
Doctrines of Equivalents—Sufficiency of Particularized Elements	<i>Malta v. Schulmerich Carillons, Inc.</i> , 952 F.2d 1320, 1331 (Fed. Cir. 1991) (observing that “before a case may be submitted to a jury, a patentee’s proof must include substantial evidence of separate and explicit comparison of the claimed and accused devices as to each of the three <i>Graver Tank</i> requirements); <i>Lear Siegler, Inc. v. Sealy Mattress Co.</i> , 873 F.2d 1422, 1426 (Fed. Cir. 1989); <i>see also Warner-Jenkinson Co. v. Hilton Davis Chem. Co.</i> , 520 U.S. 17, 29 (1997) (holding that “[e]ach element contained in a patent claim is deemed material to defining the scope of the patented invention” and that the doctrine of equivalents “must be applied to individual elements of the claim, not to the invention as a whole”)
Exception to Doctrine of Equivalents—Prosecution History Estoppel	<i>Cybor Corp. v. FAS Techs. Inc.</i> , 138 F.3d 1448, 1460 (Fed. Cir. 1998) (en banc); <i>Festo Corp. v. Shoketsu Kinzoku Kogyo Kabushiki Co., Ltd.</i> , 344 F.3d 1359, 1367 (Fed. Cir. 2003)
Exception to Doctrine of Equivalents—“All Elements” Rule/Claim Vitiating Doctrine	<i>Deere & Co. v. Bush Hog, LLC</i> , 703 F.3d 1349, 1356–57 (Fed. Cir. 2012); <i>Charles Mach. Works, Inc. v. Vermeer Mfg. Co.</i> , 723 F.3d 1376, 1380 (Fed. Cir. 2013)
Exception to Doctrine of Equivalents—Disclosed but Unclaimed Embodiments Dedicated to the Public	<i>Johnson & Johnston Assocs. Inc. v. R.E. Serv. Co.</i> , 285 F.3d 1046, 1051–52 (Fed. Cir. 2002) (en banc)
Exception to Doctrine of Equivalents—Scope of Equivalents Cannot Encompass Prior Art	<i>Wilson Sporting Goods Co. v. David Geoffrey & Assocs.</i> , 904 F.2d 677 (Fed. Cir. 1990)
Double Patenting	<i>In re Berg</i> , 140 F.3d 1428, 1432 (Fed. Cir. 1998); <i>Georgia-Pacific Corp. v. U.S. Gypsum Co.</i> , 195 F.3d 1322, 1326 (Fed. Cir. 1999)
Patent Misuse	<i>B. Braun Med., Inc. v. Abbott Labs.</i> , 124 F.3d 1419, 1427 (Fed. Cir. 1997) (observing that “the patent misuse doctrine is an extension of the equitable doctrine of unclean hands”)
Laches	<i>A.C. Aukerman Co. v. R.L. Chaides Constr. Co.</i> , 960 F.2d 1020, 1028 (Fed. Cir. 1992) (en banc); <i>but see SCA Hygiene Aktiebolag v. First Quality Baby Prods., LLC</i> , No. 13-1564, 2014 U.S. App. LEXIS 24697, 2014 WL 7460970 (Fed. Cir. Dec. 30, 2014) (granting en banc review that may revisit <i>Aukerman</i>)
Equitable Estoppel	<i>A.C. Aukerman Co. v. R.L. Chaides Constr. Co.</i> , 960 F.2d 1020, 1028 (Fed. Cir. 1992) (en banc)
Assignor Estoppel	<i>Carroll Touch, Inc. v. Electro Mech. Sys., Inc.</i> , 15 F.3d 1573, 1579 (Fed. Cir. 1993)

Doctrine	Authority
Common-Law Experimental Use	<i>Madey v. Duke Univ.</i> , 307 F.3d 1351, 1358 (Fed. Cir. 2002)
Injunctive Relief	<i>eBay Inc. v. MercExchange, LLC</i> , 547 U.S. 388 (2006)

Table 6.2
Patent Issues—Questions of Fact

Doctrine	Authority
Utility	<i>Juicy Whip, Inc. v. Orange Bang, Inc.</i> , 185 F.3d 1364, 1365 (Fed. Cir. 1999)
Novelty (Anticipation) § 102	<i>Orion IP, LLC v. Hyundai Motor Am.</i> , 605 F.3d 967, 974 (Fed. Cir. 2010)
Derivations § 102(f)	<i>Gambro Lundia AB v. Baxter Healthcare Corp.</i> , 110 F.3d 1573, 1576 (Fed. Cir. 1997)
Written Description § 112	<i>Fujikawa v. Wattanasin</i> , 93 F.3d 1559, 1569–70 (Fed. Cir. 1996); <i>Eiselstein v. Frank</i> , 52 F.3d 1035, 1038 (Fed. Cir. 1995) (“Compliance with the ‘written description’ requirement is a question of fact, to be reviewed under the clearly erroneous standard.”)
Literal Infringement	<i>Markman v. Westview Instruments, Inc.</i> , 517 U.S. 370, 384 (1996); <i>DSC Commc’n Corp. v. Pulse Commc’ns, Inc.</i> , 170 F.3d 1354, 1368 (Fed. Cir. 1999) (whether an accused device performs the specific function associated with the § 112(f) means limitation); <i>In re Hayes Microcomputer Prods.</i> , 982 F.2d 1527, 1541 (Fed. Cir. 1992); <i>Moleculon Research Corp. v. CBS, Inc.</i> , 793 F.2d 1261, 1269–70 (Fed. Cir. 1986)
Doctrine of Equivalents— Determining Equivalency	<i>Warner-Jenkinson Co. v. Hilton Davis Chem. Co.</i> , 520 U.S. 17, 38 (1997) (although “noting various legal limitations on the application of the doctrine of equivalents are to be determined by the court, either on a pretrial motion for partial summary judgment or on a motion for judgment as a matter of law at the close of the evidence and after the jury verdict,” such as prosecution history estoppel, “all elements” rule, “disclosed by unclaimed embodiments” rule, and rule that scope of equivalents cannot encompass prior art)

Doctrine	Authority
Patent Exhaustion	<p><i>Cornell Univ. v. Hewlett-Packard Co.</i>, 2008 WL 5671886 (N.D.N.Y. 2008) (Rader, J., sitting as a district judge) (Reasoning that “when determining whether a doctrine is legal or equitable, the focus is not solely on the nature of the remedy. The inquiry must also consider the origin of the doctrine. Although case law is scarce with respect to the nature of the patent exhaustion doctrine, the Supreme Court has recognized that patent exhaustion has its roots in the patent law statutory framework. <i>Bloomer v. McQuewan</i>, 55 U.S. 539, 549 (1852) (“When he sells the exclusive privilege of making or vending it for use in a particular place, the purchaser buys a portion of the franchise which the patent confers.”). In other words, when the patentee has given up his right to exclude, there is no longer a statutory basis for the patentee to impose restrictions on the subsequent sale or use of the article. Given this statutory framework, it follows that patent exhaustion is a legal doctrine, rather than an equitable one.”)</p>
Reverse Doctrine of Equivalents	<p><i>Hartness Int’l, Inc. v. Simplimatic Eng’g Co.</i>, 819 F.2d 1100, 1110, 2 U.S.P.Q.2d 1826, 1833 (Fed. Cir. 1987); <i>SRI Int’l v. Matsushita Elec. Corp.</i>, 775 F.2d 1107, 1125 (Fed. Cir. 1985)</p>
Actual Damages	<p><i>Cybor Corp. v. FAS Techs., Inc.</i>, 138 F.3d 1448, 1461 (Fed. Cir. 1998) (en banc)</p>
Lost Profits	<p><i>Rite-Hite Corp. v. Kelley Co.</i>, 56 F.3d 1538, 1543–44 (Fed. Cir. 1995) (en banc)</p>
Reasonable Royalty	<p><i>Unisplay, S.A. v. Am. Elec. Sign Co.</i>, 69 F.3d 512, 517 (Fed. Cir. 1995) (“The determination of the amount of damages based on a reasonable royalty is an issue of fact.”)</p>
Willful Infringement— Factual Components	<p><i>WBIP, LLC v. Kohler Co.</i>, __ F.3d __ (Fed. Cir. July 19, 2016) (“We do not interpret [the Supreme Court’s decision in <i>Halo Electronics, Inc., v. Pulse Electronics, Inc.</i>, No. 14-1513 (June 3, 2016)] as changing the established law that the factual components of the willfulness question should be resolved by the jury” (footnote omitted)). See § 7.3.4.5.</p>

Table 6.3
Patent Issues—Questions of Law Based on Underlying Questions of Fact

Doctrine	Authority
Claim Construction in General	<i>Teva Pharm. USA, Inc. v. Sandoz, Inc.</i> , 135 S. Ct. 831 (2015) (standard of appellate review); <i>Markman v. Westview Instruments, Inc.</i> , 517 U.S. 370 (1996)
Indefinite Claiming § 112(b)	J. Jonas Anderson & Peter S. Menell, <i>Restoring the Fact/Law Distinction in Patent Claim Construction</i> , 109 Nw. U. L. Rev. Online 187, 198–200 (2015) (discussing the interplay of claim construction and indefiniteness post- <i>Teva</i>); § 5.2.5.2
On-Sale Bar § 102(b)	<i>Del. Valley Floral Grp., Inc. v. Shaw Rose Nets, LLC</i> , 597 F.3d 1374, 1379 (Fed. Cir. 2010); <i>Gemmy Indus. Corp. v. Chrisha Creations Ltd.</i> , 452 F.3d 1353, 1358 (Fed. Cir. 2006); <i>Robotic Vision Sys., Inc. v. View Eng'g, Inc.</i> , 249 F.3d 1307, 1310 (Fed. Cir. 2001) (“Whether an invention was on sale within the meaning of § 102(b) is a question of law that this court reviews <i>de novo</i> ; however, factual findings underlying a district court’s conclusions are subject to the clearly erroneous standard of review.”)
Public Use Bar § 102(b)	<i>Clock Spring, L.P. v. Wrapmaster, Inc.</i> , 560 F.3d 1317, 1324 (Fed. Cir. 2009); <i>Motionless Keyboard Co. v. Microsoft Corp.</i> , 486 F.3d 1376, 1383 (Fed. Cir. 2007)
Printed Publication Bar § 102(b)	<i>Orion IP, LLC v. Hyundai Motor Am.</i> , 605 F.3d 967, 974 (Fed. Cir. 2010); <i>ResQNet.com v. Lansa, Inc.</i> , 594 F.3d 860, 865 (Fed. Cir. 2010)
Priority of Invention § 102(g)	<i>Cooper v. Goldfarb</i> , 154 F.3d 1321, 1327 (Fed. Cir. 1998) (“Priority, conception, and reduction to practice are questions of law which are based on subsidiary factual findings.”); <i>Fujikawa v. Wattanasin</i> , 93 F.3d 1559, 1564, 1567 (Fed. Cir. 1996) (“The ultimate determination of reduction to practice is a question of law”; “Suppression or concealment is a question of law which we review <i>de novo</i> .”); <i>Checkpoint Sys., Inc. v. U.S. Int’l Trade Comm’n</i> , 54 F.3d 756, 761 (Fed. Cir. 1995) (“As the parties asserting invalidity, respondents at the ITC bore the burden of establishing, by clear and convincing evidence, facts which support the ultimate legal conclusion of invalidity under § 102(g).”); <i>Tex. Instruments, Inc. v. Int’l Trade Comm’n</i> , 871 F.2d 1054, 1068 (Fed. Cir. 1989) (due diligence for priority of invention under 35 U.S.C. § 102(g) is a question of fact)

Doctrines	Authority
Nonobviousness § 103	<i>KSR Int'l, Co. v. Teleflex, Inc.</i> , 550 U.S. 398, 427 (2007) (“The ultimate judgment of obviousness is a legal determination.”); <i>Daiichi Sankyo Co., Ltd. v. Apotex, Inc.</i> , 501 F.3d 1254, 1256 (Fed. Cir. 2007); <i>Winner Int'l Royalty Corp. v. Wang</i> , 202 F.3d 1340, 1349 (Fed. Cir. 2000) (“What a reference teaches and whether it teaches toward or away from the claimed invention are questions of fact.”) (quoting <i>In re Bell</i> , 991 F.2d 781, 784 (Fed. Cir. 1993)); <i>Sibia Neurosciences, Inc. v. Cadus Pharm. Corp.</i> , 225 F.3d 1349, 1356 (Fed. Cir. 2000) (“Determining whether there is a suggestion or motivation to modify a prior art reference is one aspect of determining the scope and content of the prior art, a fact question subsidiary to the ultimate conclusion of obviousness.”); <i>Graham v. John Deere Co.</i> , 383 U.S. 1, 17 (1966) (there are four factual questions underlying the obviousness determination: (1) the scope and content of the prior art is one of the four underlying fact; (2) differences between the subject matter claimed and the prior art; (3) level of ordinary skill in the art; and (4) objective indicia of nonobviousness (secondary considerations))
Prior Inventor	<i>Solvay S.A. v. Honeywell Int'l, Inc.</i> , 622 F.3d 1367, 1375 (Fed. Cir. 2010); <i>Monsanto Co. v. Mycogen Plant Sci., Inc.</i> , 261 F.3d 1356, 1362 (Fed. Cir. 2001)
Inventorship	<i>Sewell v. Walters</i> , 21 F.3d 411, 415 (Fed. Cir. 1994) (inventorship is a question of law with “any facts found . . . in reaching an inventorship holding . . . reviewed for clear error”); <i>Ethicon, Inc. v. United States Surgical Corp.</i> , 135 F.3d 1456, 1460 (Fed. Cir. 1998); <i>Hess v. Adv. Cardiovascular Sys., Inc.</i> , 106 F.3d 976, 980 (Fed. Cir. 1997) (whether an inventor is improperly named or improperly omitted is a question of fact)
Enablement § 112	<i>Alza Corp. v. Andrx Pharm., LLC.</i> , 603 F.3d 935, 939 (Fed. Cir. 2010); <i>Ortho-McNeil Pharm, Inc. v. Mylan Labs., Inc.</i> , 520 F.3d 1358, 1365 (Fed. Cir. 2008); <i>Quaker City Gear Works, Inc. v. Skil Corp.</i> , 747 F.2d 1446, 1453–54 (Fed. Cir. 1984)
Estoppel Based on Standard Setting	<i>Rambus Inc. v. Infineon Techs. AG</i> , 318 F.3d 1081, 1087 n.3 (Fed. Cir. 2003)
Inequitable Conduct	<i>Therasense, Inc. v. Becton, Dickinson & Co.</i> , 649 F.3d 1276 (Fed. Cir. 2011) (en banc)

Doctrine	Authority
Enhanced Damages § 284	<i>Halo Electronics, Inc., v. Pulse Electronics, Inc.</i> , No. 14-1513 (Supreme Court June 3, 2016) (Although the ultimate resolution is for the court, the decision does not squarely address whether any role remains for the jury). The Federal Circuit has since ruled that the factual components of the willfulness questions should be resolved by the jury. See <i>WBIP, LLC v. Kohler Co.</i> , ___ F.3d ___ (Fed. Cir. July 19, 2016); § 7.3.4.5.

Table 6.4
Patent Issues—Unresolved Characterization

Doctrine	Authority
Statutory Subject Matter § 101	<i>Mayo Collaborative Servs. v. Prometheus Labs., Inc.</i> , 132 S. Ct. 1289 (2012); <i>Assoc. for Molecular Pathology v. Myriad Genetics, Inc.</i> , 133 S. Ct. 2107 (2013); <i>Alice Corp. Pty. Ltd. v. CLS Bank Int'l</i> , 134 S. Ct. 2347 (2014); <i>Accenture Global Servs., GmbH v. Guidewire Software, Inc.</i> , 728 F.3d 1336, 1340–41 (Fed. Cir. 2014)
Structural Equivalents Under § 112(f)	<i>Lockheed Martin Corp. v. Space Sys./Loral, Inc.</i> , 324 F.3d 1308, 1319 (Fed. Cir. 2003) (“Once a court establishes that a means-plus-function limitation is at issue, it must identify and construe that limitation, thereby determining what the claimed function is, and what structures disclosed in the written description correspond to the ‘means’ for performing that function.”); <i>Vulcan Eng’g Co. v. Fata Aluminum, Inc.</i> , 278 F.3d 1366, 1373–76 (Fed. Cir. 2002) (holding that determining a corresponding structure, which includes equivalents to the disclosed structures, is a matter of claim construction); <i>but see In re Bond</i> , 910 F.2d 831, 833 (Fed. Cir. 1990) (observing that “structural equivalency under section 112(f) is a question of fact”) (citing <i>Pennwalt Corp. v. Durand-Wayland</i> , 833 F.2d 931, 933–34 (Fed. Cir. 1987) (en banc)); <i>Asyst Techs., Inc. v. Empak, Inc.</i> , 268 F.3d 1364, 1373 (Fed. Cir. 2001) (explaining that whether an accused structure is equivalent to the disclosed structure for purposes of § 112(f) is a question of fact)

6.1.2 Summary Judgment and Claim Construction

Claim construction plays a central role in scheduling and managing summary judgment motions. Generally, the pretrial issues requiring the largest investment of judicial resources in a patent case are claim construction and summary judgment. Furthermore, most of the weighty issues in a patent case—the technical aspects of

infringement and most allegations of invalidity—often depend on claim construction. As a result, summary judgment on the main issues in a patent case (infringement and validity) generally cannot be resolved without construing at least some disputed claim terms. For this reason, most courts construe at least the disputed claim terms that the parties have signaled are dispositive of infringement and/or invalidity issues before considering summary judgment motions. Tackling both claim construction and summary judgment at the same time can be daunting, and taking them a step at a time may be prudent in certain cases.

In cases presenting multiple similar and interrelated claim construction disputes, which can generally be resolved using similar evidence, considerable efficiency results from addressing all claim construction issues together in a single proceeding. Resolving claim construction disputes does not by itself resolve a case, unless it fosters settlement or the parties stipulate that claim construction is entirely dispositive of the infringement allegations. Moreover, not all claim construction disputes are essential to resolving a case—sometimes construing just a single disputed claim term is all that is needed to decide a case-dispositive summary judgment motion. In those situations, it can be inefficient to resolve all claim construction disputes before considering summary judgment motions that could obviate further trial court proceedings. Assertive case management can help the court and the parties identify the best approach for each particular case.

The recommendations that follow reflect two guiding principles: (1) summary judgment motions that turn entirely or principally on claim construction should be decided concurrently with claim construction, and (2) where genuine opportunities to resolve or narrow a case early through summary judgment exist, the parties and the court should take advantage of them. Collectively, these recommendations provide a framework for early (“first-track” and “off-track”) summary judgment motions through which courts can analyze the specific facts of a case and identify when such motion practice can resolve or substantially narrow the case.

6.1.3 Recommended Dual-Track Approach to Summary Judgment

The tension between devoting judicial and party resources to claim construction while simultaneously preparing for dispositive motions can be productively resolved in many cases by using a dual-track approach to the summary judgment process. On the first (expedited) track are motions that depend primarily on claim construction. On the second track are motions that require resolution of substantial issues beyond claim construction. In some cases, it may be worthwhile to consider summary judgment outside either of these tracks—what we refer to as “off-track” summary judgment motions. Figure 6.1 illustrates the tracks along a timeline.

Figure 6.1
Multitrack Motions for Summary Judgment (MSJ) Process for Patent Cases

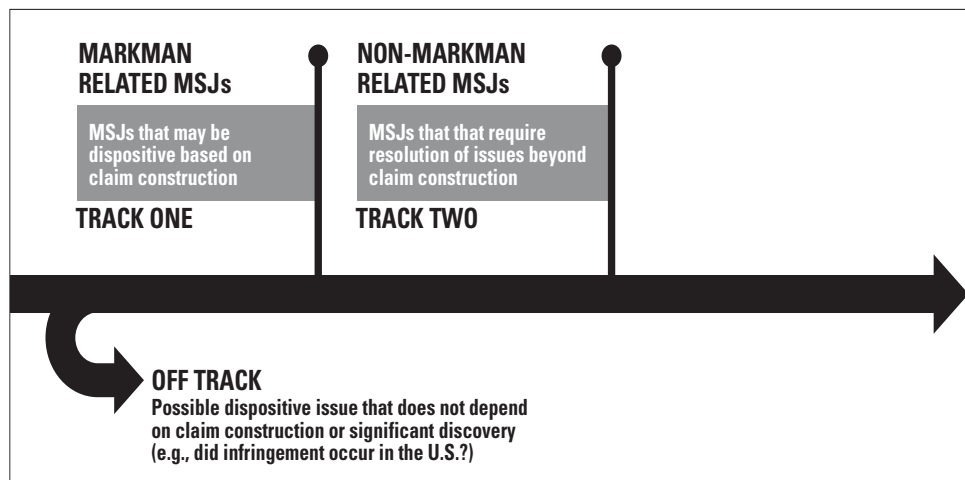

6.1.3.1 “First-Track” Summary Judgment Motions

Since “first-track” motions are based on the resolution of claim construction issues, they most often seek summary judgment of noninfringement. For example, in *Planet Bingo, LLC v. Gametech International, Inc.*, 472 F.3d 1338 (Fed. Cir. 2006), the claims at issue required “establishing a predetermined combination as a winning combination.” *Id.* at 1340. The accused bingo machines determined winning combinations after the bingo game began. The parties disputed whether this could be encompassed by the claim term “predetermined.” The district court construed “predetermined” to mean a determination made before the game began. This precluded literal infringement. Based on this construction and a finding that making a determination *after* the bingo game began could not be equivalent to making the determination *before* the game began, the district court granted summary judgment of noninfringement. The Federal Circuit affirmed. *Id.* at 1338. In *Planet Bingo*, all that needed to be resolved was the construction of “predetermined” and the issue of what could be “equivalent” to “predetermined”—all other disputes, claim construction or otherwise, were mooted. *See also, e.g., Schoenhaus v. Genesco, Inc.*, 440 F.3d 1354, 1356 (Fed. Cir. 2006) (affirming issuance of a “carefully crafted summary judgment opinion” that “construed two limitations of claim 1 of the patent” in lieu of a claim construction order).

Owing to the interrelationship between claim construction and first-track motions, most first-track motions should be resolved as a part of, or in temporal proximity to, the claim construction process. Courts should first determine whether there are any issues that may be resolved by the construction of a single term or a small set of terms. Where such an issue exists, claim construction and first-track motions should be addressed concurrently. Claim construction is often complex. Counterintuitively, considering first-track motions concurrently with claim construction can

simplify the claim construction process by focusing the disputes and providing better context with which to understand them. It can also significantly reduce the expenditure of judicial and party resources by eliminating the need to consider all of the parties' claim construction disputes. Indeed, waiting to address such motions until long after claim construction eliminates the potential efficiency of early resolution of the case based on the construction of a single term or a small set of terms. If the court does not prioritize construing crucial terms on which summary judgment could be rendered, the court may address most or all of the claim construction disputes, only to find that only one of those disputes actually mattered to the resolution of the case.

Another benefit of hearing first-track summary judgment motions with claim construction is that it can give the court context for understanding the parties' claim construction disputes. Technically, the accused product is not a factor in claim construction. *Scripps Clinic & Research Found. v. Genentech, Inc.*, 927 F.2d 1565, 1580 (Fed. Cir. 1991) ("The words of the claims are construed independent of the accused product."). Nonetheless, the Federal Circuit has expressly directed district judges to construe claims with an eye to the ultimate issues and disputes in a case. *Id.* ("Of course the particular accused product (or process) is kept in mind, for it is efficient to focus on the construction of only the disputed elements or limitations of the claims."). Indeed, it is "highly undesirable" to consider claim construction issues "without knowledge of the accused devices," *Mass. Inst. of Tech. v. Abacus Software*, 462 F.3d 1344, 1350 (Fed. Cir. 2006), because they provide the "proper context for an accurate claim construction." *Lava Trading, Inc. v. Sonic Trading Mgmt. LLC*, 445 F.3d 1348, 1350 (Fed. Cir. 2006). Summary judgment briefing can also reveal the motives underlying claim construction disputes. Of course, information about the issues in the case need not be provided to the court by summary judgment motions. For example, the court can obtain this information through a tutorial, at a case-management conference, or through the claim construction briefing or hearing.

An alternative is to hear first-track motions prior to the normal claim construction process. If the court determines that a case-dispositive issue turns on the construction of a limited number of terms, it will often make sense to allow a party to file a first-track motion on that issue at an earlier stage of the case and conduct a "mini-*Markman*" in parallel to construe only the terms on which the motion depends. Allowing this flexibility, where the party seeking to file the motion demonstrates that the motion is both viable and likely to resolve or substantially narrow the case, can dramatically reduce the court's (and the parties') investment of time and resources in the case.

6.1.3.2 "Second-Track" Summary Judgment Motions

"Second-track" summary judgment motions involve substantial issues beyond claim construction, and therefore should not normally be considered as part of the claim construction process. Claim construction issues and first-track motions often involve a common set of legal principles and evidence. It makes sense to consider them together. Second-track summary judgment motions involve legal principles and evidence above and beyond the underlying claim construction issues. Moreover,

as discussed previously, most courts find that it is best to resolve claim construction issues midway through a case, both to facilitate settlement and so that the parties can prepare for trial knowing what the claim construction is. *See* § 5.1.1. Unless the second-track motion is straightforward and unaffected by claim construction (for example, a challenge to standing, *see* § 2.2.1), making the effort to consider a second-track summary judgment motion before issuing a claim construction order diverts judicial resources from that goal.

6.1.3.3 Implementing a Dual-Track Approach to Summary Judgment

To resolve cases with this dual-track approach, the court must distinguish between the tracks and enforce the distinction. Because of their complexity or the specific facts at issue, some cases do not present realistic opportunities to implement a dual-track approach: claim construction might not drive the dispute; there may be no issues that can be resolved before fact discovery is completed; or factual disputes might obscure those issues at the outset of the case. Courts implementing a dual-track approach can rely on submissions and dialogue with the parties to overcome this latter hurdle. The court must manage the case actively and set expectations early, so that any potential first-track summary judgment motions are identified promptly, vetted by the court to determine whether they are indeed first-track motions, and ultimately briefed prior to or in parallel with the claim construction process. This helps ensure that Fed. R. Civ. P. 56(d) issues do not derail the court's ability to grant a meritorious first-track motion and dispose of the case early.

An essential component of the dual-track process is early notice to the parties of the procedure the court intends to follow. The court should explain the first-track motion concept to the parties in a standing order for patent cases, at the initial case-management conference, or both. Setting proper expectations is especially important where the local rules of a court limit the total number of summary judgment motions or the total number of pages that may be filed with respect to summary judgment motions. For a dual-track approach to be effective, the parties need to know, for example, whether bringing a first-track motion will impede their ability to file a second-track motion later in the case.

To manage the case efficiently, the court should also set a deadline in the case schedule for a summary judgment motion on the first track issues. To avoid unfairness and/or conflicts with Fed. R. Civ. P. 56(d), there should also be a deadline for providing notice to the other party of the basis for any planned first-track motion, including at least the identity of any witnesses who will submit evidence in support of the motion. These deadlines could be the same, provided that the deadline is far enough in advance of the claim construction hearing to allow the opposing party time to perform reasonably necessary discovery, such as deposing the witnesses who submit declarations in support of the first-track motion.

Another way to streamline the process while avoiding Fed. R. Civ. P. 56(d) issues is to require the movant to identify first-track motions early in the case, then require the parties to take discovery on the issues in any first-track motions concurrently with

claim construction discovery and disclosures. After this limited discovery is complete, the court can then hear the first-track motions with the claim construction hearing.

Courts must also set expectations to avoid the submission of multiple first-track summary judgment motions. One option is to limit each party to a single first-track motion. Once the briefing is complete, the court could review it and decide whether to consider it along with claim construction. Another option is to require a party to obtain leave of court before filing a first-track motion. This may be the best approach to address the tension that may exist where a jurisdiction only allows one summary judgment motion to be filed without leave. In such jurisdictions, courts should still encourage strong first-track motions, but the court should be clear during the case management conference or in the scheduling order as to whether the first-track motion will be a party's only chance for summary judgment during the course of the case.

Procedurally, the court could require that a party wishing to file a first-track motion submit a two- or three-page letter brief with the court within two weeks of submitting the Joint Claim Construction Statement required under some courts' Patent Local Rules. The letter brief would describe the proposed first-track motion and why it should be heard with claim construction. The court could then evaluate how to proceed. This would also afford the opposing party notice of the basis of the motion, to avoid Fed. R. Civ. P. 56(d) problems.

Appendix 6.1 contains a sample standing order for first-track summary judgment motions. It permits each party to file a single first-track summary judgment motion without leave of court but requires a motion for leave to file additional first-track motions. It is designed to integrate the Patent Local Rules originated by the Northern District of California, although it can be used in any district whether or not the district has adopted a version of those Patent Local Rules. If there are no Patent Local Rules, the court can remove the references in the sample order to those rules. The remaining text in the sample order stands on its own.

6.1.3.4 Recognizing First-Track Summary Judgment Motions

6.1.3.4.1 Noninfringement and Divided Infringement

Noninfringement motions based on a small set of claim terms are the most likely to be first-track motions. This is because a judgment of noninfringement is appropriate if any single claim limitation is not met. *See* § 14.4.1.4. Often, the same or similar claim limitations appear in each of the independent claims. If those claim limitations are not met, literal infringement (and possibly infringement under the Doctrine of Equivalents) cannot be established and the case (or at least some aspects of it) is resolved. Claims that depend on such claims need not be considered because they cannot be infringed if the independent claims are not infringed.

Another area of noninfringement that may be suited to first-track summary judgment motions is where there is divided infringement. The Federal Circuit has emphasized that where an accused infringer does not perform all the steps of an accused method, it cannot be liable for infringement unless it otherwise controls or directs each step of the accused method. *Muniauction, Inc. v. Thomson Corp.*, 532 F.3d 1318 (Fed. Cir. 2008) (reversing a jury verdict of infringement); *BMC Resources*,

Inc. v. Paymentech, LP, 498 F.3d 1373, 1380 (Fed. Cir. 2007) (affirming a judgment of noninfringement). Mere “arms-length cooperation” is not enough to show the necessary control or direction. *BMC*, 498 F.3d at 1381. Instead, “there can only be joint infringement when there is an agency relationship between the parties who perform the method steps or when one party is contractually obligated to the other person to perform the steps.” *Akamai Techs., Inc. v. Limelight Networks, Inc.*, 629 F.3d 1311, 1320 (Fed. Cir. 2010), *rev’d on other grounds*, 692 F.3d 1301 (Fed. Cir. 2012) (en banc) (per curiam), *rev’d*, 134 S. Ct. 2111 (2014). The Supreme Court’s *Akamai* decision left this rule undisturbed—the Supreme Court declined to review *Muniauction* in reaching its conclusion that “a defendant is not liable for inducing infringement under § 271(b) when no one has directly infringed under § 271(a) or any other statutory provision.” *Limelight Networks, Inc. v. Akamai Techs., Inc.*, 134 S. Ct. 2111 (2014). Unless and until *Muniauction* is revisited, divided-infringement noninfringement defenses are prime candidates for first-track motions (or off-track motions, if the issue in a given case does not turn on claim construction).

6.1.3.4.2 Invalidity Challenges Under § 112

While noninfringement motions are the most common first-track summary judgment candidates, invalidity issues under § 112 can often be suitable for resolution in a first-track motion. Especially in the aftermath of the Supreme Court’s decisions in *Teva Pharmaceuticals USA, Inc. v. Sandoz, Inc.*, 135 S. Ct. 831 (2015), and *Nautilus, Inc. v. Biosig Instruments, Inc.*, 134 S. Ct. 2120, 2128 (2014), we can expect greater focus on claim indefiniteness determinations. As explored in § 5.2.5.2, claim construction and claim indefiniteness are typically intertwined, making claim indefiniteness potentially ripe for first-track resolution. The considerations that led the Supreme Court to hold in *Markman* that claim construction is a matter for the court (and not a jury) should logically apply to assessing claim indefiniteness. Furthermore, even if the question of claim indefiniteness is subject to a different evidentiary standard (clear and convincing) than claim construction because of § 282’s presumption of validity,¹ it is difficult to imagine a scenario in which a judge decides

1. In *Nautilus*, the Supreme Court noted, without resolving, controversy over the standard for proving claim indefiniteness:

As the parties appear to agree, . . . th[e] presumption of validity does not alter the degree of clarity that §112[(b)] demands from patent applicants; to the contrary, it incorporates that definiteness requirement by reference. See §282, ¶2(3) (defenses to infringement actions include “[i]nvalidity of the patent or any claim in suit for failure to comply with . . . any requirement of [§112]”).

The parties nonetheless dispute whether factual findings subsidiary to the ultimate issue of definiteness trigger the clear-and-convincing evidence standard and, relatedly, whether deference is due to the PTO’s resolution of disputed issues of fact. We leave these questions for another day. The court below treated definiteness as “a legal issue [the] court reviews without deference,” 715 F.3d, at 897, and *Biosig* has not called our attention to any contested factual matter—or PTO determination thereof—pertinent to its infringement claims.

Nautilus, Inc., 134 S. Ct. at 2130, n.10.

that a term could not be construed under the preponderance standard but declines to hold that it is indefinite, owing to the higher threshold for proving invalidity. See J. Jonas Anderson & Peter S. Menell, *Restoring the Fact/Law Distinction in Patent Claim Construction*, 109 Nw. U. L. Rev. Online 187, 198–200 (2015) (discussing the interplay of claim construction and indefiniteness post-*Teva*). By contrast, lack of written description is typically less susceptible to early resolution because it often requires factual development through discovery. While written description is a question of fact, a patent can nonetheless be held invalid “on its face” for lack of adequate written description. *Univ. of Rochester v. G.D. Searle & Co.*, 358 F.3d 916, 927 (Fed. Cir. 2004) (describing written description standard and listing cases where a patent was held invalid “on its face” under this standard). Of the § 112 invalidity defenses, enablement is typically the least susceptible to resolution in a first-track motion. Although the ultimate judgment is a question of law, that determination rests on underlying factual issues that often must first be developed through both fact and expert discovery before it is ripe for decision, even where the decision ultimately turns on a claim construction issue. See, e.g., *MagSil Corp. v. Hitachi Global Storage Techs., Inc.*, 687 F.3d 1377 (Fed. Cir. 2012) (stating that enablement is a question of law based on underlying factual findings and affirming summary judgment of non-enablement after the close of fact and expert discovery).

6.1.3.4.3 Invalidity Challenges Under §§ 102 and 103

Whether a summary judgment motion regarding invalidity based on anticipation or obviousness will fall in the first track depends on how many disputes the court needs to resolve, and of what type. Normally, a motion based on anticipation or obviousness will not be a first-track motion because to prove either, the moving party must show that every limitation in every claim is present in the prior art. This typically gives rise to a host of disputes, at least some of which are not governed primarily by claim construction issues. Therefore, these motions are normally not first-track motions. Motions seeking to defeat an anticipation defense are more likely to be first-track motions for the same reasons discussed above with respect to noninfringement—if the patentee can establish the absence of a single element in the allegedly anticipatory reference, the reference does not anticipate. It is possible for a question of anticipation or obviousness to turn in either direction on a small number of issues that are manageable early on in the case. For example, if it is beyond dispute that the patented invention is a specific improvement on a specific prior art device, the validity of the patent may turn on whether the specific improvement is obvious. Now that the Supreme Court has emphasized that obviousness is a legal conclusion for the courts, it is much more likely that, even under the patentee’s version of the facts, claimed inventions will be obvious. See *KSR Int’l Co. v. Teleflex, Inc.*, 550 U.S. 398, 425 (2007); *PharmaStem Therapeutics, Inc. v. ViaCell, Inc.*, 491 F.3d 1342, 1362 (Fed. Cir. 2007) (reversing order denying judgment of invalidity based on obviousness); *Tokai Corp. v. Easton Enters., Inc.*, 632 F.3d 1358 (Fed. Cir. 2011) (affirming summary judgment of obviousness); *Odom v. Microsoft Corp.*, 429 F. App’x 967, 2011 U.S. App. LEXIS 9115 (Fed. Cir. 2011) (affirming summary judgment of obviousness); see also § 6.2.1.1.2.

6.1.3.4.4 Invalidity Challenges Under § 101

After a long dormancy, patentable subject-matter challenges have become one of the most salient and rapidly evolving areas of patent litigation. From the early 1980s until 2007, invalidity challenges based on patentable subject matter gained little traction. Notwithstanding remarkable advances in computers and biotechnology, the Supreme Court's decisions in *Diamond v. Chakrabarty*, 447 U.S. 303 (1980), and *Diamond v. Diehr*, 450 U.S. 175 (1981), cabined earlier cases that limited the patentability of software-related inventions and opened the patent system to information-age technologies. See § 14.3.1.2.3. At the same time, Congress established the Federal Circuit Court of Appeals and it gradually expanded on the *Chakrabarty* and *Diehr* precedents, eventually approving the patent eligibility of DNA sequence claims and business methods. See § 14.3.1.2.4. The USPTO lowered the patentability screen accordingly, leading to vast patenting of biotechnology, software, and business methods in the late 1990s and early 2000s.

With growing concerns about the patent system following the bursting of the tech bubble in late 1999, the Federal Circuit gradually opened its doors to § 101 challenges. See, e.g., *In re Nuijten*, 500 F.3d 1346 (Fed. Cir. 2007) (holding that a water-marked electromagnetic signal does not fall into any of the four categories of patent-eligible subject matter); *In re Bilski*, 545 F.3d 943 (Fed. Cir. 2008) (en banc). Beginning in 2010, the Supreme Court reentered the patentable subject matter field, issuing an unprecedented four substantial § 101 decisions—*Bilski v. Kappos*, 561 U.S. 593 (2010); *Mayo Collaborative Services v. Prometheus Laboratories, Inc.*, 132 S. Ct. 1289 (2012); *Association for Molecular Pathology v. Myriad Genetics, Inc.*, 133 S. Ct. 2107 (2013); and *Alice Corp. Pty. Ltd. v. CLS Bank Int'l*, 134 S. Ct. 2347 (2014)—over five terms and substantially reshaping the terrain. See § 14.3.1.2.5.

Since these decisions apply retroactively, the lower courts now face a raft of patentable subject matter challenges to patents issued during a period when the PTO applied little to no § 101 screen. Moreover, the Supreme Court's decisions leave some basic and critical questions unresolved. See § 14.3.1.3.

The *Alice* decision synthesizes two centuries of jurisprudence into a two-step test:

- Step 1: Does the patent claim a patent-ineligible law of nature, natural phenomena, or abstract idea?
- Step 2: If so, does the claim contain an inventive concept sufficient to transform the ineligible law of nature, natural phenomena, or abstract idea into a patent-eligible application of the ineligible subject matter?

See *Alice*, 134 S. Ct. at 2355 (attributing the framework to *Mayo*, 132 S. Ct. at 1294–98); § 14.3.1.1. The ultimate question of patentable subject matter appears to be a question of law and, in applying this framework, the Supreme Court has not treated the framework as implicating underlying factual findings. See *id.* at 2355–60. However, it has not explicitly addressed whether this framework does, or could, involve underlying factual findings and, if so, whether those determinations are within the province of the court. Conceptually, both steps of the test could entail subsidiary

factual findings in some cases. Under step 1, for example, a court might need to resolve disputes about how laws of nature operate. Under step 2, a court might need to hear expert testimony about whether the *application* of a patent-ineligible law of nature, physical phenomenon, or abstract idea is inventive or merely routine or conventional.

The lower federal courts have only just begun to grapple with these issues. See *DDR Holdings, LLC v. Hotels.com, L.P.*, 773 F.3d 1245 (Fed. Cir. 2014); *Ultramercial, Inc. v. Hulu, LLC*, 772 F.3d 709, 715 (2014); *Ameritox Ltd. v. Millennium Health, LLC*, 2015 U.S. Dist. LEXIS 19665, 2015 WL 728501 (W.D. Wisc. Feb. 18, 2015); *Cal. Inst. of Tech. v. Hughes Commc'ns, Inc.*, 59 F. Supp. 3d 974 (C.D. Cal. 2014); *Cogent Med., Inc. v. Elsevier Inc.*, 2014 U.S. Dist. LEXIS 139856, 2014 WL 4966326 (N.D. Cal. Sept. 30, 2014). The law's evolution is having an impact on interrelated threshold issues: (1) whether claim construction is necessary to the resolution of a § 101 challenge, and (2) what sort of motion should be filed, and when.

Prior to 2010, § 101 challenges were typically asserted at the summary judgment stage. In 2010, following the Supreme Court's decision in *Bilski v. Kappos*, 561 U.S. 593 (2010), accused infringers began to file Rule 12 motions to dispose of certain asserted claims on § 101 grounds at the pleading stage. Over the past several years, the number of cases dismissed at the pleading stage has risen from one in 2012 to eleven in 2014.

The Federal Circuit has stated that “claim construction is not an inviolable prerequisite to a validity determination under § 101,” but at the same time has remarked that “it will ordinarily be desirable—and often necessary—to resolve claim construction disputes prior to a § 101 analysis, for the determination of patent eligibility requires a full understanding of the basic character of the claimed subject matter.” *Bancorp Servs., L.L.C. v. Sun Life Assurance Co.*, 687 F.3d 1266, 1273–74 (Fed. Cir. 2012). Faced with a body of law that is emerging, and litigation strategies that are evolving, district courts have several options in assessing how to place § 101 motions within a track.

First, the district court may decide a § 101 motion without construing claims where the claim is clearly ineligible under the Supreme Court's teachings. See, e.g., *Fort Props., Inc. v. Am. Master Lease, LLC*, 609 F. Supp. 2d 1052 (C.D. Cal. 2009), *aff'd*, 671 F.3d 1317 (Fed. Cir. 2012) (invalidating claims under § 101 without discussion of claim construction). A court might elect this approach if it were deciding a Rule 12(b)(6) or 12(c) motion, or possibly an “off-track” summary judgment motion. For example, in *Ultramercial, Inc. v. Hulu, LLC*, the Federal Circuit affirmed the district court's grant of the accused infringer's pre-answer motion to dismiss under Rule 12(b)(6) “without formally construing the claims.” 772 F.3d 709, 713 (Fed. Cir. 2014). The Federal Circuit stated that it, like the district court, conducted its § 101 analysis “[w]ithout purporting to construe the claims.” *Id.* at 714. As litigants test the nascent boundaries of § 101 law and movants attempt to dismiss asserted claims early in litigation on § 101 grounds, however, patentees opposing such motions may increasingly argue that certain claim terms require construction, which in turn relate to factual disputes about the nature of the asserted claims.

In the second approach—which appears more frequently following the Supreme Court’s trilogy of § 101 decisions in *Mayo*, *Myriad*, and *Alice*—the district court decides a § 101 motion after considering the non-movant patentee’s proposed constructions, but without formal claim construction proceedings. This was, in fact, the posture of *Alice*. 134 S. Ct. at 2360, *affg*, *CLS Bank Int’l v. Alice Corp. Pty. Ltd.*, 717 F.3d 1269 (Fed. Cir. 2013), *affg*, *CLS Bank Int’l v. Alice Corp. Pty. Ltd.*, 768 F. Supp. 2d 221, 236 n.6 (D.D.C. 2011) (“To have the Court consider CLS’s § 101 defense before conducting a possible *Markman* hearing, CLS agreed to assume a construction of claims favorable to Alice.”) (internal citation omitted). Similarly, in another case, the Federal Circuit deemed “proper” the district court’s grant of a motion to dismiss under Fed. R. Civ. P. 12(b)(6) at the pleading stage, where the court had “construed the terms identified by [the non-movant] ‘in the manner most favorable to [the non-movant],’” but without formal claim construction proceedings. *Content Extraction & Transmission LLC v. Wells Fargo Bank, Nat’l Ass’n*, 776 F.3d 1343, 1348–49 (Fed. Cir. 2014). This second approach suggests that even where the non-movant contends that a § 101 defense depends in some way on claim construction, it is often still appropriate to consider a motion at the pleading stage or as an off-track summary judgment motion.

A third approach is for the district court to decide a § 101 motion after a claim construction hearing “to ensure that there are no issues of claim construction that would affect the [c]ourt’s legal analysis of the patentability issue.” *Loyalty Conversion Sys. Corp. v. Am. Airlines, Inc.*, No. 2:13-CV-655, 2014 U.S. Dist. LEXIS 122244, 2014 WL 4364848, at *4 (E.D. Tex. Sept. 2, 2014) (Bryson, J., sitting by designation). In *Loyalty Conversion*, the district court waited until after the claim construction hearing, even though the § 101 challenge was a motion for judgment on the pleadings pursuant to Fed. R. Civ. P. 12(c). In another case, the district court held a claim construction hearing on the same day as a hearing on the accused infringer’s Rule 12(c) motion, and granted the latter, noting that “[t]he Court’s claim construction ruling, which is being issued separately today, has no impact on Defendant’s Rule 12(c) motion.” *buySAFE, Inc. v. Google Inc.*, 964 F. Supp. 2d 331, 333 (D. Del. 2013) *aff’d*, 765 F.3d 1350 (Fed. Cir. 2014). A court following this approach could hear the § 101 issue in a first-track or second-track motion.

As this discussion suggests, the Supreme Court’s recent decisions have encouraged parties to file dispositive motions based on § 101 at an increasing rate. At least in part, this results from the Court’s decision in *Mayo* and confirmed in *Alice* establishing a two-step framework that simplified the § 101 analysis, making it better suited for early resolution in many cases. Nonetheless, the reach of the Supreme Court’s § 101 holdings and how the Federal Circuit will apply them is still in flux. *Compare Ultramercial, Inc. v. Hulu, LLC*, 772 F.3d 709, 715–16 (Fed. Cir. 2014) (finding that the claims fail under § 101 despite computer-implemented limitations that require “updating an activity log, requiring a request from the consumer to view [an] ad, restrictions on public access, and use of the Internet”), *with DDR Holdings, LLC v. Hotels.com, L.P.*, 773 F.3d 1245, 1258–59 (Fed. Cir. 2014) (finding that the claims satisfy § 101 because they did not “broadly and generically claim ‘use of the Internet’ to perform an abstract business practice (with insignificant added activity)”). Never-

theless, § 101 issues are more susceptible to resolution on summary judgment (or motions under Rules 12(b)(6) or 12(c)) than they were just a few years ago.

To resolve § 101 defenses through early dispositive motions, courts should consider several issues. First, while § 101 issues are susceptible to early resolution in many cases, courts should not assume that first-track or off-track motions are appropriate in every case. Because of the nature of, and substantial attention paid to, the Supreme Court's recent § 101 decisions, there is a danger that dispositive § 101 motions will become (and some would argue, already have become) the motion *du jour*. In other words, as often happens with “hot” issues, parties in some cases can be expected to overreach by suggesting early resolution of § 101 issues where it is unwarranted, for example because it appears that the motion is unlikely to succeed or because it is unlikely to apply to enough of the asserted claims or patents to materially change the scope of the case. Second, and as an important counterpoint, the very characteristics that often make patent claims attractive to patentees in the infringement context, and thus more likely to be asserted in litigation—e.g., broad reach, functional claim terms, generically claimed components—also make a claim more likely to be invalid under § 101. Consequently, experience teaches that the percentage of claims that would appropriately be held invalid under the Supreme Court's § 101 standards is likely higher (and perhaps substantially higher) for claims that are asserted in litigation as compared to all claims in all issued patents, considered in the aggregate. Courts should be careful not to make assumptions either way. They should not assume that a proposed motion should be heard as a first-track or off-track motion simply because it is based on § 101; nor should they assume that the motion is overreaching and, therefore, inappropriate for first-track or off-track resolution simply because it addresses all claims in a patent, or multiple (or even all) patents asserted in the case. Instead, courts should require the party seeking to file a first-track or off-track summary judgment motion to explain the proposed motion, in a letter brief or otherwise, so that the court can evaluate whether the motion is well suited for early resolution in view of the applicable law.

6.1.4 Summary Judgment Independent from Claim Construction (Off-Track)

The discussion above focuses on early summary judgment motions that depend on claim construction. While this typically includes most dispositive issues in a patent case, at least two categories of early summary judgment motions that are not based on claim construction arise with some frequency. First, as discussed above, some dispositive issues (e.g., § 101 invalidity, divided infringement) implicate claim construction in some cases and not in others, depending on the particular facts of the case. Whether tied to claim construction or not, these issues are often ripe for resolution at an early stage for the reasons discussed above.

Second, a few dispositive issues typically do not intersect with claim construction at all. For example, territoriality issues—whether the alleged infringement occurred “in the United States”—usually will not involve claim construction. For such motions, the above first-track/second-track approach does not apply as directly.

Considering a summary judgment motion before issuing a claim construction order can divert the resources of both the court and the parties from resolving the claim construction issues by the mid-point in a case. *See* § 2.1.3.2. In general, however, considering an off-track summary judgment motion before claim construction may make sense if the issue is potentially dispositive of the case as a whole or of a significant issue or issues. Indeed, where it is case dispositive and likely to succeed, a court should consider taking on that motion first, before devoting its time and resources to claim construction. This is especially true for courts that conduct claim construction after discovery closes or immediately before trial, where the savings of time and resources that would result from granting the motion early in the case would be the most substantial.

6.1.5 Streamlining the Summary Judgment Process

No matter when they choose to decide motions for summary judgment, courts can streamline the process in several ways. Table 6.5 summarizes the principal approaches.

Table 6.5
Approaches to Streamlining the Summary Judgment Process

Approach	Advantages	Disadvantages
Letter briefs asking permission to file summary judgment motions	<ul style="list-style-type: none"> • The court has full view of the possible summary judgment issues and their potential to narrow the case. • The court saves time and effort by prohibiting the filing of weak motions. 	<ul style="list-style-type: none"> • Slightly lengthens the summary judgment process. • The short summary contained in the letter briefing may give the court a distorted picture of the proposed motion.
Limiting the number of summary judgment motions or the total number of pages	<ul style="list-style-type: none"> • Forces the parties to focus and identify their best arguments to the court; reduces the burden on the court of ruling on a stack of motions. 	<ul style="list-style-type: none"> • Discourages parties from bringing summary judgment motions earlier in the case. • Limits the court's opportunity to dispose of issues prior to trial and create a more manageable trial.
Multiple rounds of summary judgment motions	<ul style="list-style-type: none"> • May allow additional efficiency by narrowing the issues to be decided at any time. 	<ul style="list-style-type: none"> • May increase the total number of motions filed and encourage parties to file motions on minor issues.

6.1.5.1 Recommended Approach: Letter Briefs Followed by Summary Judgment Motions

Some courts employ a pre-motion letter briefing process to limit the number of summary judgment motions filed by the parties. Each party is required to submit a letter brief summarizing each proposed motion. The court then holds a telephone hearing during which each of the proposed motions is discussed. After this hearing, the court identifies which of the motions may be filed. Some courts allow the parties to file one motion without leave and require leave of court for any motions beyond the first.

The obvious advantage of this approach is that it gives the court an overview of the possible summary judgment issues and their potential to narrow the case. This allows the court to manage its docket with a better understanding of the impact of its decisions. The letter-brief approach allows courts to evaluate a potential first-track or off-track motion to determine whether it would be sensible to decide the proposed motion at an early stage of the case. The court can tailor its limits on summary judgment motions to suit the needs of each particular case.

Disadvantages of the letter-brief approach may include an increase in resources required to manage the case, a somewhat longer summary judgment process, and possible distortion of complex issues by forcing the parties to compress their arguments. However, these risks are small compared to the benefit of not considering a large number of motions, and a more flexible alternative allows the parties to file a single motion without leave of court. In many cases, one motion will be enough and the parties will be content to not file letter briefs requesting leave to file additional motions.

If the parties have competent advocates, they can usually convey enough information to the court in two to three pages and five minutes of oral argument to enable the court to evaluate whether the substance of a proposed motion justifies a full briefing.

6.1.5.2 Limiting the Number of Summary Judgment Motions or the Number of Pages of Summary Judgment Briefing

Some courts limit the number of summary judgment motions the parties can bring during the life of a case; some limit the total number of pages of summary judgment briefing that can be filed; and others implement a limit based on various permutations of the above.

Where a court or jurisdiction limits the number of summary judgment motions that can be brought during the life of a case, or is considering doing so, it should inform the parties early in the case, ideally at the initial case-management conference. Such limitations can affect the parties' litigation strategy and practice. Limiting summary judgment motions in this way has the significant advantage of forcing the parties to focus on and identify their best arguments, and it can significantly reduce the burden on the court. On the other hand, limiting the number of summary judgment motions can reduce the chance for early disposition of the case—because, for example, a party may not be willing to proceed on a potential first-track or off-track

motion. This can also limit the court's opportunity to create a more manageable dispute by narrowing the issues early in the case. In general, this approach is not recommended because it lacks flexibility. These issues are magnified where a jurisdiction has a local rule or standing order limiting each party to one summary judgment motion per case. In those instances, the court should evaluate whether the default rule fits each case and should be clear with the parties from the outset about whether it will or will not count a proposed first-track or off-track motion against this limit.

Some courts employ a variation of this approach in which they do not limit the number of summary judgment motions, but instead require all motions to be addressed in a single brief conforming to the usual page limits required by the jurisdiction. This approach does not streamline the summary judgment process. Because parties may bring any number of motions, it does not necessarily reduce the number of issues that the court will have to decide. By limiting each party to a single brief with the usual page limitations, it significantly reduces a party's ability to quote and discuss the importance of evidence supporting the motion. Thus, instead of easing the burden on the court, this approach often results in dense briefs that string-cite evidence, forcing the court to pick through voluminous evidence to reach the merits of the motion. The inefficiencies of this approach are most pronounced when a party brings two or three well-founded motions for summary judgment, but cannot treat any one motion fully. Consequently, we recommend against this variation.

To streamline the process and reduce the burden on the court, but also avoid the issues created by adherence to a strict motion limit or default page limit, some courts consider the potential issues in the case and then limit the total number of pages of summary judgment briefing that can be filed. This hybrid approach requires the parties to select their best arguments and be judicious in the number and scope of motions filed. Nonetheless, it does not arbitrarily limit the number of motions that a party can bring. To determine an appropriate total page limit for briefing, the court should indicate to the parties that it intends to implement such limitations early on in the case, and then during a case-management conference in advance of summary judgment briefing discuss with the parties a reasonable limitation for total pages based on the potential motions in the case. Such a discussion will also help the court evaluate the merits of such motions and establish a reasonable page limitation for the motions that the court will allow the parties to file.

6.1.5.3 Multiple Rounds of Summary Judgment Hearings

In addition to the multi-track approach to summary judgment briefing, other alternatives are also available to make patent cases more manageable and to use judicial resources better. For example, it can be useful to allow or encourage several rounds of summary judgment hearings. This approach makes the most sense in larger cases, in cases where a large number of motions are expected to be filed, or in cases where the parties identify narrow summary judgment motions on issues that require little or no discovery early in the litigation. This approach works best where the first round of motions focuses on issues that can narrow the scope of the case significantly. This allows the court to limit its expenditure of resources on issues that need

not be raised later in the case if the issues can be narrowed early. The resolution of major issues early in a case may also encourage settlement.

Another alternative for large patent cases where multiple patents are asserted is to require each patentee to identify “champion” patents and then limit the proceedings to the champion patents until the infringement, invalidity, and other contentions regarding those patents are resolved. In most multi-patent cases, each party should be able to identify its strongest patents and the court may choose to proceed first with these champion patents. This approach may help resolve a case by encouraging settlement if the issues on the strong patents are resolved or narrowed in the early rounds.

A drawback of multiple rounds or multiple hearings is that the approach may increase the total number of motions filed in the case, and it may encourage parties to file motions on minor issues. Another drawback of multiple rounds is the potential delay that it may cause in the case. Thus, where multiple rounds are used, the court should, during the case-management stage, discuss with the parties the number of rounds of summary judgment that it plans to utilize, whether it is open to hearing first-track motions, whether it plans to require the parties to designate champion patents, or whether the court plans to implement any limitations regarding number of pages of briefing or the number of motions. As discussed above, the court can request that the parties notify it of any intended motions early in the case and use that discussion to determine appropriate limits.

6.1.6 The Summary Judgment Hearing

Hearings on motions for summary judgment in patent cases usually present the same issues as other types of cases. However, several issues—the length and division of time, live testimony, the use of graphics, and whether to hold a technology tutorial—raise distinctive concerns in patent cases. Table 6.6 provides the advantages and disadvantages of two approaches to the summary judgment hearing.

Table 6.6
Approaches to the Summary Judgment Hearing

Approach	Advantages	Disadvantages	Examples
Live testimony	<ul style="list-style-type: none"> • Affords the court the opportunity to hear testimony focused on the issues on which the motion turns. 	<ul style="list-style-type: none"> • Inconsistent with MSJ standard. • Time-consuming. • Invites cumulative testimony. 	
Graphics	<ul style="list-style-type: none"> • May assist the court in understanding complex technical distinctions. 	<ul style="list-style-type: none"> • Invites longer presentations. • Challenging to keep a precise record. 	PowerPoint presentations

6.1.6.1 Length and Division of Time

The length of time needed for a summary judgment motion varies widely depending on the court's preferences and the scope and nature of the issues at stake. As an example, a motion seeking summary judgment of infringement implicates a broad scope of issues and may require significantly more time than a motion for summary judgment of noninfringement, which might focus on the absence of a single claim limitation. Typically, whatever time the court allots to the hearing should be divided equally between the parties, and each party should be free to elect how best to use it.

6.1.6.2 Live Testimony

As the factual issues relevant to a motion for summary judgment are sufficiently settled before a motion is brought, live testimony during the hearing is rarely appropriate. Live testimony can be unduly time-consuming and invite cumulative evidence. However, it can be useful in limited circumstances where declarations submitted by the parties do not squarely address each other, creating the perception of a question of material fact when, in reality, one may not exist. In such circumstances, live testimony may allow the court to probe discrepancies in the testimony that may affect whether summary judgment is appropriate.

6.1.6.3 Graphics

Most courts permit the parties to use graphics, such as PowerPoint slides, during their presentations. This can be particularly helpful to the court in patent cases, where visual aids may assist the court in understanding nuanced technical issues. Such presentations help most when they present issues in a functional manner—i.e., through the use of graphical illustrations, charts, and documentary evidence. Where they merely repackage the arguments in briefs with bullet points, such presentations can be inefficient.

6.1.6.4 Technology Tutorial

Because the technology implicated by the patents-in-suit, accused products, and prior art is often complex and unfamiliar to the court, a technology tutorial may clarify the issues to be decided. Whether this should occur in conjunction with summary judgment will depend on the timing of summary judgment relative to claim construction—where technology tutorials are most prevalent, *see* Chapter 5—and the court's needs. If the court holds a tutorial in conjunction with a prior *Markman* hearing, it might not need to hold a second one. The court should nevertheless consider whether the scope of technical issues discussed at the *Markman* stage encompassed the technical information relevant to the summary judgment stage. It often does not because summary judgment frequently implicates a broader set of technical issues. If summary judgment coincides with or precedes claim construction, this weighs in favor of holding a tutorial in connection with the summary

judgment hearing. The methodology of the tutorial can take various forms, including a neutral presentation by counsel, a presentation by each party's experts or by a technical advisor to the court, and written submissions by the parties followed by a question-and-answer session. These options are discussed in § 5.1.2.2.

6.1.7 Expert Declarations Filed in Connection with Summary Judgment Motions

Because summary judgment motions in patent cases will typically be both supported and opposed by expert declarations, a central issue in most patent summary judgment motions will be evaluating the extent to which expert declarations create (or fail to create) genuine issues of fact that preclude summary judgment.

6.1.7.1 Some Expert Testimony Cannot Defeat Summary Judgment

6.1.7.1.1 Testimony About Conclusions of Law

Expert opinions directed to a conclusion of law are insufficient to defeat summary judgment. *KSR Int'l Co. v. Teleflex, Inc.*, 550 U.S. 398, 426 (2007) (“To the extent the court understood the *Graham [v. John Deere]* approach to exclude the possibility of summary judgment when an expert provides a conclusory affidavit addressing the question of obviousness, it misunderstood the role expert testimony plays in the analysis.”).

Moreover, expert opinions directed to a conclusion of law are generally considered irrelevant because it is the court's role to decide issues of law. However, this distinction can be confusing in patent cases because there are a number of questions of mixed fact and law that may be raised in such cases, for example with respect to obviousness. Courts should, therefore, evaluate carefully the specific opinions that any experts offer to determine whether such opinions are permissible to consider on summary judgment.

6.1.7.1.2 Conclusory Testimony

The conclusory testimony of an expert, at least when standing alone, is not sufficient to defeat summary judgment. *Telemac Cellular Corp. v. Topp Telecom, Inc.*, 247 F.3d 1316 (Fed. Cir. 2001) (“broad conclusory statements offered by *Telemac's* experts are not evidence and are not sufficient to establish a genuine issue of material fact”); *Arthur A. Collins, Inc. v. N. Telecom, Ltd.*, 216 F.3d 1042, 1046 (Fed. Cir. 2000); *In re Dembiczak*, 175 F.3d 994, 999 (Fed. Cir. 1999).

6.1.7.1.3 Testimony Contradicting Clear Disclosure of Prior Art

Expert testimony that purports to contradict the clear disclosure of a prior art reference is insufficient to defeat summary judgment. *Jamesbury Corp. v. Litton In-*

dus. Prods. Inc., 756 F.2d 1556, 1563 (Fed. Cir. 1985) (overturning a jury verdict of anticipation), *overruled in part by A.C. Aukerman Co. v. R.L. Chaides Constr. Co.*, 960 F.2d 1020 (Fed. Cir. 1992).

6.1.7.1.4 Testimony Contradicting Admissions of a Party

In *PharmaStem Therapeutics, Inc. v. ViaCell, Inc.*, 491 F.3d 1342, 1362 (Fed. Cir. 2007), the Federal Circuit refused to give weight to expert testimony proffered by the patentee about the nature of the prior art that contradicted statements in the specification of the patent-in-suit about that art. As a result of these limitations, the mere existence of apparently conflicting expert testimony from both parties does not necessarily mean that questions of material fact preclude summary judgment. For additional limitations on expert testimony, *see* § 7.4.

6.1.7.2 Legal Insufficiency of Expert Testimony

Proffered expert testimony may also fail to navigate patent law’s substantive requirements correctly, rendering it of little to no relevance. The most common failing in this regard concerns the timing of the substantive analysis. Whether a patent claim is obvious is measured at the time of invention. Thus, expert opinions about obviousness must focus on what would be known or obvious to a person of ordinary skill *at the time of invention*. But enablement is measured at the time the application was filed, *In re Wands*, 858 F.2d 731, 736–37 (Fed. Cir. 1988); infringement, including equivalency under the doctrine of equivalents, at the time of alleged infringement, *see, e.g., Warner-Jenkinson Co. v. Hilton Davis Chem. Co.*, 520 U.S. 17, 37 (1997); and equivalency under § 112(f), at the time the patent issued, *Al-Site Corp. v. VSI Int’l, Inc.*, 174 F.3d 1308, 1320 (Fed. Cir. 1999). An opinion based on an analysis that focuses on the wrong point in time does not address the substantive standard relevant to the motion. Likewise, an expert opinion about anticipation that does not address whether the asserted prior art reference is enabling may not satisfy the substantive standard. *See, e.g., Forest Labs., Inc. v. Ivax Pharm., Inc.*, 501 F.3d 1263, 1268 (Fed. Cir. 2007). An opinion that fails to address the substantive standard may have little to no probative value. As a result, it may be appropriate to exclude the testimony under Federal Rules of Evidence 402 and 702.

6.1.7.3 Expert Testimony Beyond the Scope of the Expert Report

In patent cases, parties commonly argue that expert testimony regarding summary judgment should be stricken or disallowed because it goes beyond the scope of the expert’s reports. This arises in a number of contexts:

- a *Celotex* “failure of proof” argument for summary judgment, based on the absence of opinion or evidence in an expert report, *see, e.g., Telemac Cellular Corp. v. Topp Telecom, Inc.*, 247 F.3d 1316 (Fed. Cir. 2001);
- an argument that a declaration opposing summary judgment should be stricken; and

- expert testimony through declaration that is contrary to deposition testimony.

The consequences of either allowing or disallowing expert testimony that is beyond the scope of the expert's report should be examined carefully. However, courts should keep in mind the Federal Circuit's clear support for allowing the district court discretion to make procedural rulings that are effectively case dispositive. See *O2 Micro Int'l, Ltd. v. Monolithic Power Sys., Inc.*, 467 F.3d 1355, 1368–69 (Fed. Cir. 2006) (finding court did not abuse its discretion in excluding untimely expert reports).

Moreover, it is important for a court to also consider that allowing an expert declaration to stand for a point that is outside the scope of the expert's report on the subject has the practical effect of granting a motion by that party to serve a supplemental expert report. This can be problematic and prejudicial both from a case-management perspective and to the party against whom the declaration has been offered. Where such an expert declaration has been allowed, the scope of the trial will inevitably expand to include testimony on that new point. As discussed in § 7.5.2.3, allowing a supplemental expert report may also unfairly prejudice the party against whom it is offered by raising issues requiring a responsive expert supplementation. Because the substantive underpinnings of validity and infringement are intertwined, a supplemental expert report in the form of a declaration submitted in connection with a motion for summary judgment of noninfringement may justify a responsive supplementation not only on the issue of infringement but also on the issue of validity.

Unfortunately, courts often do not confront this issue. Faced with a request to strike an expert declaration filed in connection with summary judgment, courts commonly remain silent about the request to strike and simply decline to cite the declaration in the opinion. Alternatively, some courts will defer a ruling on the issue until later in the case. These practices should be avoided. They risk basing an important decision on an incomplete record, and they reward a party that failed to proffer a proper, timely report with an unfair advantage. These approaches effectively inject the additional opinions from the declaration into the case, but without any recognition by the court that this has occurred. At best, the receiving party may depose the expert, which will weaken any prejudice argument, and often leads the court to allow the opinions. But the result is often that the party against whom the opinions are offered has little or no opportunity to offer responsive expert opinions, especially because this issue typically arises late in the case. Instead, courts should explicitly address the request to strike as soon as possible and, if the matter is new, either strike that new matter or recognize that the declaration is a supplemental expert report. If the court permits the declaration as a supplementation, it should then provide the receiving party with an opportunity to depose the expert on the supplemental opinions and to offer responsive expert testimony of its own, thus allowing the parties to establish a complete record. Active management by the court will prevent the disclosing party from circumventing the court's schedule and improperly offering belated expert opinions. Section 7.5.2.3 explores these issues further.

6.1.8 Narrowing Trial Issues Through Federal Rule of Civil Procedure 56(g)

Even where summary judgment is not appropriate, summary judgment proceedings may nevertheless be helpful in simplifying a patent case for trial. Federal Rule of Civil Procedure 56(g), as implemented by the 2010 Amendments, states that where “the court does not grant all the relief requested by the motion, it may enter an order stating any material fact—including an item of damages or other relief—that is not genuinely in dispute and treating the fact as established in the case.” This provision is particularly useful for patent cases because many of the facts necessary to prove infringement or validity are often undisputed, and this rule can now be used to help narrow the issues in a case.

For example, as discussed in § 14.4.1.4, infringement requires that each claim limitation be present in the accused device. As another example, the same rule applies to anticipation—each claim limitation must be disclosed in the asserted prior art reference. Thus, the party advancing the infringement claim or anticipation defense must present evidence at trial corresponding to each claim limitation. But the party opposing that claim or defense often disputes the presence of only a small subset of these claim elements. If the court can determine, based on the evidence presented at summary judgment, which limitations are undisputed, Fed. R. Civ. P. 56(g) permits it to narrow the infringement or anticipation portion of the trial to only those elements in dispute. This can significantly simplify a trial.

Although a court should apply Fed. R. Civ. P. 56(g) wherever possible, it must do so carefully, considering the scope of the motion and the relative burdens of proof. The court should utilize this rule only where the issues have been joined fully in the summary judgment proceedings. For example, when an accused infringer cites the absence of only one claim limitation in its noninfringement summary judgment motion, it is not necessarily admitting that there are no disputes as to the other limitations. The accused infringer may simply be choosing to move for summary judgment on its strongest noninfringement argument. The same is true of the patentee in the anticipation context. As another example, in some cases the party opposing the motion acknowledges in its briefing or oral argument that certain issues underlying the motion are not disputed. When this happens, a Fed. R. Civ. P. 56(g) order is appropriate.

6.2 Substantive Issues Commonly Raised During Summary Judgment

Some issues in patent cases are more amenable to summary judgment than others. In part, this is because some issues, such as infringement or anticipation, are factual and some, such as obviousness, are primarily legal in nature. There are also different standards of proof: infringement requires only a preponderance of the evidence while invalidity requires clear and convincing evidence. Some motions require a narrow scope of proof while others require that the movant prove a much broader set of facts. For example, noninfringement is more likely to be amenable to summary

judgment than infringement, because a patentee must show that each limitation of a claim is found in each accused device. Conversely, an accused infringer need only show the absence of a single limitation to avoid infringement. As a result, the accused infringer's burden on summary judgment is more likely to be satisfied because a narrower scope of proof is required. Finally, some issues are more amenable to summary judgment because the underlying facts are not typically disputed; only the conclusions to be drawn from them are in dispute.

6.2.1 Issues More Amenable to Summary Judgment

This section explores the motions within validity, infringement, and damages that summary judgment can generally resolve.

6.2.1.1 Validity

An accused infringer must prove invalidity by clear and convincing evidence. The Supreme Court has observed that while the standard for proving invalidity does not change, the fact that a material reference was not before the USPTO may make the standard easier to meet. *Microsoft Corp. v. i4i Ltd. P'ship*, 131 S. Ct. 2238, 2251 (2011).

Simply put, if the PTO did not have all material facts before it, its considered judgment may lose significant force. And, concomitantly, the challenger's burden to persuade the jury of its invalidity defense by clear and convincing evidence may be easier to sustain. In this respect, although we have no occasion to endorse any particular formulation, we note that a jury instruction on the effect of new evidence can, and when requested, most often should be given.

Id. (citations omitted).

In general, the heavy burden for invalidity makes summary judgment on validity issues more likely for patentees than accused infringers. But, as discussed below, the nature of several invalidity defenses often renders them amenable to summary judgment for either party.

6.2.1.1.1 Patentable Subject Matter

The precise contours and character of patentable subject matter limitations are still emerging following the Supreme Court's recent and substantial foray into § 101 law. District courts will need to assess how to learn the pertinent technological background, build an appropriate record, and apply the Supreme Court's somewhat opaque standard. They will also need to determine what role, if any, there is for a jury.

The *Alice* two-step test, *see* § 14.3.1.1, has made § 101 better suited to resolution at the summary judgment stage, or even much earlier. For example, in *buySAFE, Inc. v. Google Inc.*, the Federal Circuit explained that “[a] claim that directly reads on matter in the three identified categories [(laws of nature, natural phenomena, and abstract ideas)] is outside section 101.” 765 F.3d 1350, 1353 (Fed. Cir. 2014) (citing *Mayo*, 132 S. Ct. at 1293). But, the panel added, § 101 “also excludes the subject mat-

ter of certain claims that by their terms read on a human-made physical thing (‘machine, manufacture, or composition of matter’) or a human-controlled series of physical acts (‘process’) rather than laws of nature, natural phenomena, and abstract ideas.” *Id.* In that situation, the claim is patent ineligible if “(a) it is ‘directed to’ matter in one of the three excluded categories and (b) ‘the additional elements’ do not supply an ‘inventive concept’ in the physical realm of things and acts—a ‘new and useful application’ of the ineligible matter in the physical realm—that ensures that the patent is on something ‘significantly more than’ the ineligible matter itself.” *Id.* (quoting *Alice*, 134 S. Ct. at 2355, 2357). The *buySAFE* panel applied that framework to hold that method claims that were “squarely about creating a contractual relationship” were directed to an abstract idea. *Id.* at 1354–55. Other post-*Alice* Federal Circuit decisions have applied the two-step framework toward a variety of claims in a variety of technological contexts. See, e.g., *In re BRCA1- & BRCA2-Based Hereditary Cancer Test Patent Litig.*, 774 F.3d 755, 763 (Fed. Cir. 2014) (holding patent ineligible composition claims directed to DNA primers because they lacked “a unique structure, different from anything found in nature,” and method claims directed to screening for alteration of gene because the recited method steps involved abstract ideas and “only routine and conventional steps”); *Content Extraction & Transmission LLC v. Wells Fargo Bank, Nat’l Ass’n*, 776 F.3d 1343, 1346–49 (Fed. Cir. 2014) (holding patent ineligible method claims “drawn to the abstract idea of 1) collecting data, 2) recognizing certain data within the collected data set, and 3) storing that recognized data in a memory”).

One rapidly developing area of the law is the application of the *Alice* test to computer- and software-related inventions, where the boundaries between an unpatentable abstract idea and a patentable application of that idea remain unsettled. One tool that courts have used to address such issues is the “machine-or-transformation” test, which states that a claim can be patent-eligible under § 101 if (1) it is tied to a particular machine or apparatus, or (2) if it transforms a particular article into a different state or thing. In *Bilski*, the Supreme Court rejected the machine-or-transformation test as the single broad standard for evaluating subject matter under § 101. It observed that it is nevertheless a “useful and important clue, an investigative tool, for determining whether some claimed inventions are processes under § 101.” *Bilski v. Kappos*, 561 U.S. 593, 604 (2009). More recently, the Federal Circuit concluded that the appropriate way to use the machine-or-transformation test is to consider it as part of *Alice*’s second step, when evaluating the additional claim elements—separately and in combination with the claim as a whole—to determine whether the result is a patentable application of the unpatentable abstract idea, law of nature, or physical phenomenon. *Ultramercial, Inc. v. Hulu, LLC*, 772 F.3d 709, 716 (Fed. Cir. 2014). In *Bilski*, the Supreme Court also explained that limiting an abstract idea to one field of use or adding token pre- or post-solution steps or components (e.g., conventional steps or components leading up to the abstract idea or following from it) does not make that concept patentable. 561 U.S. at 610 (citing *Flook* and *Diehr*).

But, even with these tools, post-*Alice* decisions reflect a varied treatment of machine implementations, particularly in the computing software contexts. On the one

hand, the Federal Circuit held patent-ineligible claims directed to “a method of using advertising as an exchange or currency.” *Ultramercial*, 772 F.3d at 715. The Federal Circuit concluded that the claims at issue recited an abstract idea, and “simply instruct the practitioner to implement the abstract idea with routine, conventional activity.” *Id.* Referencing the machine-or-transformation test, the court concluded that the claim limitations requiring specific computer-based steps, the use of a general purpose computer, and the Internet failed to satisfy that test. *Id.* at 717–18.

On the other hand, the Federal Circuit also applied the *Alice* framework to hold that system claims that “address a business challenge (retaining website visitors)” were patent eligible under *Alice*, noting that those claims were directed to solving “a challenge particular to the Internet.” *DDR Holdings, LLC v. Hotels.com, L.P.*, 773 F.3d 1245, 1257 (Fed. Cir. 2014). The court reasoned that the claims at issue did not “merely recite the performance of some business practice known from the pre-Internet world along with the requirement to perform it on the Internet,” but rather claimed a solution that “is necessarily rooted in computer technology in order to overcome a problem specifically arising in the realm of computer networks.” *Id.* Distinguishing the claims at issue in *Ultramercial*, the *DDR* panel stated that “the claims at issue here specify how interactions with the Internet are manipulated to yield a desired result—a result that overrides the routine and conventional sequence of events ordinarily triggered by the click of a hyperlink.” *Id.* at 1258. The court concluded that the claims thus recited a precise and inventive solution, which did not preempt the abstract idea of increasing sales on the Internet by retaining visitors. *Id.* at 1258–59.

Because the application of the *Alice* test is evolving rapidly, particularly in the computing and software contexts, courts facing dispositive motions based on § 101 should be especially careful to identify and consider the most recent decisions applying *Alice* to an analogous factual scenario. For additional considerations about the timing and prevalence of § 101 motions, see § 6.1.3.4.4.

6.2.1.1.2 Obviousness

The Supreme Court’s decision in *KSR Int’l Co. v. Teleflex, Inc.* clarified the analysis of obviousness in a way that makes this defense appropriate for summary judgment in some circumstances. 550 U.S. 398 (2007). Obviousness is a question of law that is evaluated based on underlying factual questions about the level of skill in the art at the time the invention was made, the scope and content of the prior art, and the differences between the prior art and the asserted claim. *Id.* at 406 (quoting *Graham v. John Deere Co.*, 383 U.S. 1, 17–18 (1966)). These “*Graham* factors” also include secondary indicia, such as commercial success of the invention, a long-felt but unsolved need for the invention, and the failure of others, that may demonstrate that the claimed invention was nonobvious. *Graham*, 383 U.S. at 17–18. However, evidence of secondary indicia are frequently inadequate to establish nonobviousness where either (1) the patentee fails to show the requisite nexus between the secondary indicia and the patent, or (2) the “claimed invention represents no more than the predictable use of prior art elements according to established functions.” *Ohio Willow Wood Co. v. Alps South, LLC*, 735 F.3d 1333, 1344 (Fed. Cir. 2013).

In *KSR*, the Court illustrated the application of the *Graham* factors, explaining that:

When there is a design need or market pressure to solve a problem and there are a finite number of identified, predictable solutions, a person of ordinary skill has good reason to pursue the known options within his or her technical grasp. If this leads to the anticipated success, it is likely the product not of innovation but of ordinary skill and common sense.

KSR, 550 U.S. at 421. Moreover, “most inventions that are obvious were also obvious to try.” *Id.* (note, though, that the reverse is not necessarily true). But an obviousness finding requires that the fact-finder consider all of the objective evidence presented by the patentee. See *Plantronics, Inc. v. Aliph, Inc.*, 724 F.3d 1343, 1355 (Fed. Cir. 2013) (reversing finding of nonobviousness on summary judgment and holding improper to conclude patent was invalid as obvious before considering objective indicia of nonobviousness); *Rothman v. Target Corp.*, 556 F.3d 1310, 1322 (Fed. Cir. 2009) (approving district court’s charge “that the jury ‘must consider’ objective indicia of nonobviousness, such as . . . licensing activity”).

In addition, *KSR* made clear that an invention may be obvious if it is the product of “common sense,” 550 U.S. at 421, but did not illustrate how “common sense” would be established. In *Mintz v. Dietz*, the Federal Circuit explained that “‘common sense’ is a shorthand label for knowledge so basic that it certainly lies within the skill set of an ordinary artisan.” 679 F.3d 1372, 1377 (Fed. Cir. 2012). The court held that it was “clear error” for the district court to (1) merely recite the words “common sense” without any support, and (2) “not consider[] or mak[e] any findings as to [patentee’s] evidence showing objective indicia of non-obviousness.” *Id.*; see also *Plantronics, Inc.*, 724 F.3d at 1354 (“[obviousness findings] grounded in ‘common sense’ must contain explicit and clear reasoning providing some rational underpinning why common sense compels a finding of obviousness”). The court subsequently affirmed a district court’s finding of invalidity based on “common sense” in *DatCard Sys., Inc. v. PacsGear, Inc.*, even though some limitations were “not clearly present” in the prior art (but were “highly suggested”). No. 10-cv-1288-MRP, slip op. at 6 (C.D. Cal. Apr. 1, 2013) (*aff’d* *DatCard Sys., Inc. v. PacsGear, Inc.*, 550 F. App’x 895 (Fed. Cir. 2014)). The claims were obvious because “[c]ommon sense can provide a reason to combine the teachings of the various references *and* to supply the missing pieces.” *Id.*

After the court has construed the claims, the parties typically dispute factual aspects of the *Graham* factors, the ways in which they are sought to be applied consistent with *KSR*, and the legal conclusion to be drawn from them. Such disputes, even if factual in nature, do not necessarily preclude summary judgment. First, factual disputes about the *Graham* factors, even if heated, may not be material. To evaluate the materiality of these disputes, the court can simply assume that the non-movant’s position about the factors is correct, draw inferences most favorable to that party in light of the assumed facts, and then evaluate the motion under that set of facts and inferences. For example, if an accused infringer moves for summary judgment of obviousness and it is apparent that there are factual disputes underlying the motion, the court can assume that the patentee’s position on the *Graham* factors is

correct and then evaluate obviousness. If the court concludes that the claim is obvious under the patentee's asserted facts, then the dispute about the underlying factors is not material and does not preclude summary judgment. Because obviousness is a question of law, the court does not have to conclude that "no reasonable juror" could find for the patentee, but only that there is clear and convincing evidence that the claimed invention was obvious under the patentee's asserted facts. This was essentially the approach taken by the district court, for example, in *Tokai Corp. v. Easton Enterprises, Inc.*, 632 F.3d 1358 (Fed. Cir. 2011). Specifically, "with regard to the level of skill in the art . . . the parties disagreed sharply. The [district] court determined, however, that the dispute was immaterial, as the court's conclusion on obviousness was the same under either party's asserted level of skill." *Id.* at 1364. The Federal Circuit affirmed the district court's summary judgment of obviousness, observing that, "[s]ince the district court found that the asserted claims would have been obvious to a less sophisticated artisan, then under the facts of this case the court could not have arrived at a different conclusion by adopting the viewpoint of one with greater skill and experience." *Id.* at 1369.

Second, *KSR* makes clear that conflicting expert testimony about the legal conclusions to be drawn from the underlying facts cannot defeat summary judgment. The court made this point explicitly: "To the extent the court understood the *Graham* approach to exclude the possibility of summary judgment when an expert provides a conclusory affidavit addressing the question of obviousness, it misunderstood the role expert testimony plays in the analysis." *KSR*, 550 U.S. at 426. As a question of law, the ultimate conclusion of obviousness or nonobviousness rests with the court. *Id.* Thus the court is *required* to ignore expert opinions about the ultimate legal issue (i.e., whether the claimed combination of limitations was "obvious"), although it should consider opinions directed at the *Graham* factors themselves (e.g., the scope and content of the prior art, and whether it collectively discloses each limitation of a claim).

Procedurally, *KSR* has made summary judgment on the ultimate issue of obviousness easier for either party to obtain. In this regard, *KSR* is equally applicable to other questions of law, such as indefiniteness, and should be considered in those contexts as well. Substantively, *KSR* makes summary judgment of obviousness substantially more accessible for accused infringers than under the old rule, as discussed in § 14.3.5.2. As a result, patentees and accused infringers alike have filed—and won—more obviousness motions than they did before *KSR*. As one example, in *Ohio Willow Wood Co. v. Alps South, LLC*, 735 F.3d 1333 (Fed. Cir. 2013), the Federal Circuit affirmed the district court's use of *KSR*'s tools to grant summary determination of obviousness. There, considering claims related to independent claims that another court already held to be obvious, the district court evaluated only the limitations added by the dependent claims—numerical limits on certain characteristics of "gel composition" and "fabric" elements—and found the dependent claims to be obvious. The Federal Circuit affirmed:

While it is true that [t]he determination of obviousness is made with respect to the subject matter as a whole, not separate pieces of the claim, nothing in the record indicates that confining the otherwise obvious "gel composition" and "fabric" limi-

tations to the recited numerical limits in the disputed dependent claims was anything other than the exercise of routine skill.

Id. at 1333–34; *see also MySpace, Inc. v. GraphOn Corp.*, 672 F.3d 1250, 1257–58 (Fed. Cir. 2012) (affirming summary judgment of obviousness and finding where “claims share a common term that lies at the heart of the invention,” district court’s limitation-by-limitation analysis, rather than analysis of claim as a whole, was adequate to support summary judgment); *Unigene Labs, Inc. v. Apotex, Inc.*, 655 F.3d 1352, 1364 (Fed. Cir. 2011) (affirming summary judgment of nonobviousness); *Odom v. Microsoft Corp.*, 429 F. App’x 967, 2011 U.S. App. LEXIS 9115 (Fed. Cir. 2011) (affirming summary judgment of obviousness); *Eisai Co., Ltd. v. Dr. Reddy’s Labs, Ltd.*, 533 F.3d 1353, 1355 (Fed. Cir. 2008) (affirming summary judgment of nonobviousness).

6.2.1.1.3 Anticipation

To prove that a patent claim is anticipated, an accused infringer must show by clear and convincing evidence that a single prior art reference contains each limitation of that claim. Conversely, the patentee only needs to show the absence of only one limitation from the prior art disclosure. The combination of this limited showing and the high burden of proof on the accused infringer often combine to make this issue amenable to summary judgment of no anticipation. For the same reasons, summary judgment of anticipation, while possible, is less common.

6.2.1.1.4 Section 112(f) Indefiniteness

Under § 112(f) (formerly § 112, ¶ 6), a patentee can draft its claims in “means-plus-function” form—e.g., claiming a “means for attaching” instead of claiming a nail—so long as it discloses in the specification structure that corresponds to the claimed function. If a patentee fails to disclose corresponding structure within the four corners of the specification, the claim is indefinite. *Budde v. Harley-Davidson, Inc.*, 250 F.3d 1369, 1376 (Fed. Cir. 2001). Note that the Supreme Court’s decision in *Nautilus, Inc. v. Biosig Instruments, Inc.*, where it loosened the standard for indefiniteness, did not purport to change (and would not logically alter) the analysis for determining whether a claim is indefinite for failing to comply with § 112(f). *See Nautilus, Inc. v. Biosig Instruments, Inc.*, 134 S. Ct. 2120, 2124 (2014) (rejecting the “insolubly ambiguous” standard in favor of the “reasonable certainty” standard); *Robert Bosch, LLC v. Snap-On, Inc.*, 769 F.3d 1094 (Fed. Cir. 2014) (post-*Nautilus* decision affirming summary judgment of indefiniteness for failure to disclose corresponding structure as required by § 112(f) without referencing *Nautilus* or the “reasonable certainty” standard). Although both types of indefiniteness arise under § 112(b)’s requirement that the claims “particularly point[] out and distinctly claim[] the subject matter” of the invention, to distinguish between the two types we refer to indefiniteness for failure to identify corresponding structure for a means-plus-function or step-plus-function claim as arising “under § 112(f).”

To constitute an adequate corresponding structure, an alleged corresponding structure must be (1) “clearly linked” to the claimed function to which it allegedly

corresponds, (2) capable of performing that function, and (3) disclosed within the four corners of the specification (e.g., disclosure in the file history is insufficient). *Budde*, 250 F.3d at 1377. Disputes about whether the specification contains a disclosure adequate to satisfy these requirements are common. For example, in the software context, the parties commonly dispute whether the patent’s description of a general-purpose computer operating software that carries out a function provides sufficient structure. This is because, by itself, a general purpose computer is not sufficient structure. *Aristocrat Techs. Austl. Pty. Ltd. v. Int’l Game Tech.*, 521 F.3d 1328, 1333 (Fed. Cir. 2008). Disclosure of an algorithm may suffice, if it is programmed to turn the general-purpose computer into a special-purpose computer, *see id.*, but whether an algorithm in a given patent is sufficiently detailed to do so is often disputed. In this example, as in most cases, this defense depends almost entirely on the disclosure of the specification of the patent-in-suit (though, in some cases, also upon expert testimony concerning the knowledge of one of ordinary skill in the art). Consequently, the range of disputed facts is usually narrow, and the issue typically turns on what conclusions can be drawn from the underlying facts. The disputes about such conclusions are often expressed in competing expert declarations. Because indefiniteness is a question of law, such disputes between experts about the ultimate conclusion do not preclude summary judgment.

6.2.1.1.5 Section 112(b) Indefiniteness Under *Nautilus*

In *Nautilus*, the Supreme Court held that, under the proper standard, “a patent is invalid for indefiniteness if its claims, read in light of the specification delineating the patent, and the prosecution history, fail to inform, with reasonable certainty, those skilled in the art about the scope of the invention.” *Nautilus*, 134 S. Ct. at 2124. In *Teva*, the Supreme Court held that claim construction may in some cases require the court to make underlying factual determinations and, in such cases, the district court’s underlying factual determinations are to be reviewed for clear error. *Teva Pharm. USA, Inc. v. Sandoz, Inc.*, 135 S. Ct. 831 (2015). The interplay between indefiniteness and claim construction is addressed in § 5.2.5.2, and a discussion of the evolution of the legal standards for indefiniteness appear in § 14.3.3.4. It is worth noting here that in some cases the *Nautilus* and *Teva* decisions are likely to change the posture in which indefiniteness arguments are presented to the court. Historically, indefiniteness was often presented to courts in the first instance in conjunction with claim construction, either through a motion for summary judgment of invalidity filed concurrently with claim construction or more commonly where a party seeks a finding of “indefiniteness” in lieu of a claim construction (and, if successful, files a follow-on motion to convert the finding into a judgment of invalidity). This practice results not only from the natural interplay between claim construction and indefiniteness, but also because the Federal Circuit’s now-defunct “insolubly ambiguous” indefiniteness standard—which heightened the focus on whether a claim was capable of construction—effectively mandated that posture for most indefiniteness issues.

By liberalizing the standard for finding that a claim is indefinite, the *Nautilus* decision invites a greater number of indefiniteness challenges at the claim-

construction stage. Nonetheless, by shifting the focus of the inquiry from whether a claim is amenable to construction to whether the language reasonably appries those skilled in the art of the bounds of the invention, *Nautilus* arguably makes at least some forms of indefiniteness less amenable to resolution through claim construction or through a first-track motion.

Indefiniteness disputes can arise in at least three conceptually different scenarios: (1) a claim or claim term is arguably incapable of construction because neither the intrinsic or extrinsic evidence resolves inherent ambiguity; (2) a claim or claim term has a clear meaning, but the clear meaning arguably fails to provide those skilled in the art reasonable certainty about the scope of the invention (e.g., because the meaning results in a subjective determination, because the meaning can be applied in at least two conflicting ways, because the meaning sets a condition that cannot be measured, or because structural elements are claimed in purely functional terms); and/or (3) the parties dispute the claim or claim term meaning and at least one of the proposed constructions arguably fails to provide those skilled in the art reasonable certainty about the scope of the invention.

Scenario 1 presents an issue properly resolved at the claim-construction stage. Claim construction and indefiniteness are both measured from the perspective of a person having ordinary skill in the art at the same point in time, and most underlying factual disputes that affect indefiniteness are likely to be resolved as part of claim construction. Scenarios 2 and 3, however, may be less appropriate for resolution at the claim-construction stage because they implicate factual disputes beyond the type of claim construction fact-finding.

Teva effectively addressed a claim-construction dispute in the context of indefiniteness scenario 3. See *Teva Pharm. USA, Inc. v. Sandoz, Inc.*, 135 S. Ct. 831 (2015). Sandoz defended on the grounds that the patent was invalid because it claimed that Copaxone’s active ingredient had “a molecular weight of 5 to 9 kilodaltons.” See *id.* at 842. Sandoz argued that there were three methods to determine this weight—peak average molecular weight (the weight of the most prevalent molecule), the weight as calculated by the average weight of all molecules, or the weight as calculated by an average in which heavier molecules count for more—and therefore *Teva*’s failure to specify a precise meaning rendered the claim indefinite. *Id.* at 842–43. *Teva*’s expert testified that skilled artisans would understand the term in question to refer to “peak average molecular weight,” which the district judge credited. *Id.*

While this determination is similar to construing the disputed claim term, it answers a distinct factual question. It remains to be seen if claim construction will parallel the claim indefiniteness across the range of cases. Furthermore, claim construction applies a different evidentiary standard (preponderance) than indefiniteness (clear and convincing evidence). As discussed in § 5.2.5.2, there is reason to believe that the standards will largely converge. Moreover, the same rationale that led the Supreme Court to rule in *Markman* that claim construction is a matter for the court (and not a jury) would appear to apply to the claim indefiniteness determination. See J. Jonas Anderson & Peter S. Menell, *Restoring the Fact/Law Distinction in Patent Claim Construction*, 109 Nw. U. L. Rev. Online 187, 198–200 (2015) (discussing the interplay of claim construction and indefiniteness post-*Teva*).

Nonetheless, courts should not assume that claim indefiniteness can be resolved through standard claim-construction proceedings. Courts should be careful to identify the precise issues involved in evaluating claim indefiniteness and be sure to afford the parties a fair opportunity to gather and present their evidence.

6.2.1.2 Infringement

As noted above, *see* § 6.2.1, infringement is generally more amenable to summary judgment than is invalidity because of its lower burden of proof (preponderance as opposed to “clear and convincing”). But because a patentee must show that every limitation of an asserted claim is present in the accused device, it is easier to demonstrate factual disputes to preclude summary judgment of infringement. Because the ultimate issue of infringement is one of fact, infringement issues that often require courts to draw inferences from the known facts, such as finding equivalency under § 112(f) and the doctrine of equivalents, are typically not well suited to summary judgment because all such inferences are drawn against the moving party. In contrast, noninfringement and various other issues are often amenable to summary judgment, as discussed below. Of course, in any given case these guidelines may not apply. For example, it is certainly possible that summary judgment of infringement could be appropriate if there are only a few issues in dispute and those issues are effectively resolved as part of claim construction.

6.2.1.2.1 Absence of Literal Infringement

An accused infringer need only show the absence of a single claim limitation from the accused device to avoid literal infringement. Because literal infringement can be defeated on such a narrow ground, motions for summary judgment of noninfringement are common.

6.2.1.2.2 Whether Infringement Under the Doctrine of Equivalents Is Barred by *Festo*

Although infringement under the doctrine of equivalents is a factual question that summary judgment cannot resolve, whether amendments of the patent during prosecution bar the patentee from asserting infringement under the doctrine of equivalents is a legal question well suited to summary judgment. A patentee is barred from asserting infringement under the doctrine of equivalents as to a claim that was amended for reasons of patentability during prosecution unless the asserted equivalent was unforeseeable at the time of the amendment, the amendment bears no more than a tangential relation to the equivalent in question, or there is some other reason suggesting that the patentee could not reasonably have been expected to describe the equivalent. *Festo Corp. v. Shoketsu Kinzoku Kogyo Kabushiki Co.*, 535 U.S. 722, 740–41 (2002); § 14.4.1.4.2.1.2. This inquiry depends largely on facts revealed by the prosecution history for the patent-in-suit. As a result, the court can often decide this issue at the summary judgment stage.

6.2.1.2.3 Whether Infringement Under the Doctrine of Equivalents Would Violate the *Wilson Sporting Goods* Doctrine

In *Wilson Sporting Goods Co. v. David Geoffrey & Assocs.*, the Federal Circuit held that there can be no infringement under the doctrine of equivalents if the asserted equivalents, combined with the remaining elements of the claim, encompass the prior art. 904 F.2d 677, 683 (Fed. Cir. 1990) (*overruled in part on other grounds* by *Cardinal Chem. Co. v. Morton Int'l*, 508 U.S. 83 (1993)); see § 14.4.1.4.2.1.3. For example, a patentee might assert that claim limitations one through four are met literally, and limitation five is met under the doctrine of equivalents. *Wilson Sporting Goods* precludes this argument if the prior art discloses literal limitations one through four combined with the element in the accused product that is asserted to be equivalent to claim limitation five. Whether an asserted range of equivalents encompasses the prior art, thus barring the application of the doctrine as advanced by the patentee, is a question of law. *Id.* at 684. Because the court makes the ultimate decision on this issue, it is often amenable to resolution at the summary judgment stage.

6.2.1.2.4 The Actions Accused of Infringement Did/Did Not Occur Within the United States

Under § 271(a), making, using, selling, offering to sell, or importing an infringing product or method *within the United States* constitutes an act of infringement. A single transaction frequently implicates multiple jurisdictions. For example, a widget may be sold by a Tokyo company to an Indiana company pursuant to a contract negotiated in Oslo, with the widgets to be shipped to Indiana f.o.b. Taiwan. In these circumstances, parties often dispute whether the transaction occurred *within the United States* as required by § 271. Parties often style motions about this issue as motions *in limine* relating to damages. For example, the defendant may seek to exclude evidence supporting some of the alleged infringing sales because those sales allegedly occurred in a foreign country. But this issue is properly addressed as one of infringement. Because these motions are substantive, courts should treat them as motions for summary judgment, rather than as *in limine* motions, to ensure that the relevant issues are fully briefed and considered. See § 7.5.

Whether an allegedly infringing act occurred within, or outside of, the United States is a question of law. See *N. Am. Philips Corp. v. Lockheed Sanders, Inc.*, 35 F.3d 1576, 1579 (Fed. Cir. 1994). Whether acts occurring within the United States are sufficient to constitute a sale, offer to sell, use, manufacture, or importation is a question of fact. See, e.g., *MEMC Elec. Materials v. Mitsubishi Materials Silicon Corp.*, 420 F.3d 1369, 1375 (Fed. Cir. 2005). Typically, the parties agree that a certain set of events took place in certain locations, but dispute the conclusions to be drawn from these events as they relate to infringement. As a result, both questions—locus of the acts and characterization of the acts—are often amenable to summary judgment.

6.2.1.2.5 The Absence of Evidence of Direct Infringement Bars Claims of Indirect Infringement

Under § 271(b) and (c), a party can be held liable for indirect infringement by contributing to a third party's infringement or by actively inducing a third party to infringe, respectively. To establish indirect infringement, the patentee must prove that specific acts of direct infringement by third parties occurred. *BMC Res., Inc. v. Paymentech, LP*, 498 F.3d 1373, 1380 (Fed. Cir. 2007) (affirming judgment of noninfringement). The analysis of direct infringement is the same for a third party as for a party and so is generally no more or less amenable to summary judgment. But, in some cases, the patentee does not focus its discovery efforts on gathering evidence of direct infringement by third parties. As a result, it is not uncommon for an accused infringer to bring a *Celotex* motion arguing that the patentee plaintiff can show no evidence of the direct infringement by third parties that is a predicate to a finding of indirect infringement against the defendant.

6.2.1.2.6 “Divided” (Joint) Infringement: The Actions Accused of Infringement Are Made by Multiple Parties, Not Just the Accused Infringer

The Federal Circuit has emphasized that where an accused infringer does not itself perform all the steps of an accused method, it cannot be liable for infringement unless it controls or directs performance of each step of the accused method. *Muniauction, Inc. v. Thomson Corp.*, 532 F.3d 1318 (Fed. Cir. 2008) (reversing a jury verdict of infringement); *BMC Res., Inc.*, 498 F.3d at 1380. Mere “arms-length cooperation” is not enough to show the necessary control or direction. *BMC Res., Inc.*, 498 F.3d at 1381. Indeed, the Federal Circuit set forth the bright line rule that “there can only be joint infringement when there is an agency relationship between the parties who perform the method steps or when one party is contractually obligated to the other person to perform the steps.” *Akamai Techs., Inc. v. Limelight Networks, Inc.*, 629 F.3d 1311, 1320 (Fed. Cir. 2010), *rev'd on other grounds*, 692 F.3d 1301 (Fed. Cir. 2012) (en banc) (per curiam), *rev'd*, 134 S. Ct. 2111 (2014).

In 2012, the Federal Circuit sitting en banc reversed the *Akamai* decision without revisiting the § 271(a) direct infringement case law and instead held that a party could be liable for induced infringement under § 271(b), even when there is no direct infringement by a single entity under § 271(a). *Limelight Networks, Inc. v. Akamai Techs., Inc.*, 134 S. Ct. 2111 (2014). That holding was reversed by the Supreme Court, which held that a defendant is not “liable for inducing infringement under § 271(b) when no one has directly infringed under § 271(a) or any other statutory provision.” *Id.* at 2115. In reaching its decision, the Supreme Court declined to review the *Muniauction* decision and assumed without deciding that the Federal Circuit's holding in *Muniauction* was correct. *Id.* at 2120. Thus, at present, *Muniauction*'s “single actor” rule for method claims controls.

By contrast, the same “single entity” rule does not appear to apply to apparatus claims. See, e.g., *Centillion Data Sys., LLC v. Qwest Commc'ns Int'l, Inc.*, 631 F.3d 1279, 1285 (Fed. Cir. 2011) (“The customer puts the system as a whole into service,

i.e., controls the system and obtains benefit from it By causing the system as a whole to perform this processing and obtaining the benefit of the result, the customer has ‘used’ the system under § 271(a).”).

Additionally, and for either an apparatus or method claim, the law is clear that “[a] patentee can usually structure a claim to capture infringement by a single party,’ by ‘focus[ing] on one entity.” *Uniloc USA, Inc. v. Microsoft Corp.*, 632 F.3d 1292, 1309 (Fed. Cir. 2011) (citing *BMC Res., Inc. v. Paymentech, L.P.*, 498 F.3d 1373, 1381 (Fed. Cir. 2007)). “That other parties are necessary to complete the environment in which the claimed element functions does not necessarily divide the infringement between the necessary parties.” *Uniloc*, 632 F.3d at 1309 (noting a claim may require two parties to function, but may be infringed by just the one who uses the claimed invention). Thus, in some circumstances, a claim may recite multiple actors without presenting a divided infringement issue.

When a party other than the accused infringer performs one or more of the steps in a method claim, the issue of whether that step is performed under the direction or control of the accused infringer may be amenable to summary judgment. The issue is so narrow in scope that the material facts may not be in dispute. Thus, summary judgment may be appropriate if those facts establish that a third party performed at least one step of the method outside the control or direction of the accused infringer.

6.2.1.2.7 Absence of Evidence Showing the Required Mental State for Indirect Infringement

There was, for some time, debate about the mental state required for indirect infringement. The Supreme Court clarified the standard for inducement in *Global-Tech Appliances, Inc. v. SEB S.A.*, 131 S. Ct. 2060 (2011), holding that “induced infringement under § 271(b) requires knowledge that the induced acts constitute infringement” of the asserted patent. *Id.* at 2068. In reaching this conclusion, the Court relied on—and embraced—its oft-overlooked decision in *Aro Manufacturing Co., Inc. v. Convertible Top Replacement Co. (Aro II)*, 377 U.S. 476 (1964), which addresses the mental state for contributory infringement under § 271(c). There, a majority of the Court held “that § 271(c) does require a showing that the alleged contributory infringer knew that the combination for which his component was especially designed was both patented and infringing.” *Id.* at 488; *see also Global-Tech*, 131 S. Ct. at 2067–68 (discussing *Aro II* and holding that § 271(b) and (c) require the “same knowledge”—that the induced act or combination to which the alleged infringer contributed was infringing.)

The Supreme Court’s clarification of the mental state for inducement and contributory infringement made disputes about whether the alleged indirect infringer possessed the requisite mental state more amenable to summary judgment. For example, where the patentee can point to no evidence showing that the alleged infringer had knowledge of the patent when the acts occurred, summary judgment may be appropriate. Likewise, where an accused infringer can show that, even though it had knowledge of the patent, it had a good-faith belief that the allegedly infringing acts or combinations did not, in fact, infringe, summary judgment may also be appropriate.

6.2.1.2.8 License and Exhaustion Defenses

Patent licenses and the doctrine of patent exhaustion create a constellation of defenses that are often amenable to summary judgment. A straightforward license defense arises when an accused infringer asserts that the acts alleged to infringe are covered by a valid license to the patent-in-suit. While the defense often involves some factual issues, such factual disputes are often limited and the primary issues in dispute are typically legal—whether a valid license contract exists, whether that contract covers both the patent-in-suit and the acts accused of infringement, and so forth. Likewise, an implied license defense—where, typically, the purchaser of a licensed product is accused of infringement based on its use or incorporation of that product into another product—is at its core a series of contractual questions focused on the rights granted by the patentee to the component manufacturer, and on the scope of rights “sold” by the component manufacturer to the downstream customer now accused of infringement. Patent exhaustion, a closely related (and often conflated) defense that arises when the patentee seeks to double-dip by enforcing its rights against both an upstream and downstream entity with respect to the same product, presents similar issues. Because each of these defenses typically involves a confined set of facts and presents legal or equitable issues that are decided by the Court, they can often be resolved, one way or the other, on summary judgment.

6.2.1.3 Damages

Many substantive issues within the damages sphere require the fact finder to draw factual conclusions from disputed evidence and so are not particularly well-suited for resolution on summary judgment. There are, however, a number of exceptions.

First, under § 287, damages against the infringer begin to accrue (1) upon actual notice of the patent or (2) upon constructive notice of the patent. When a patentee sells products embodying the invention, constructive notice can be established by marking those products with the patent number. When method claims are asserted, the marking requirement may not apply, and the patentee may be able to accrue damages from the time the patent issued. *See, e.g., Hanson v. Alpine Ski Area, Inc.*, 718 F.2d 1075, 1082–83 (Fed. Cir. 1983). There is often little dispute about whether the patentee sells an embodying product, has marked that product with the patent number, or has provided actual notice of the patent to the accused infringer prior to suit. Thus, courts are not typically asked to address the factual question whether a patentee satisfied the marking requirement. Instead, the parties typically dispute whether, given the nature of the asserted and non-asserted claims in the patent-in-suit, marking was required at all. This is a narrow, legal issue that can often be decided at the summary judgment stage.

Second, when one side’s expert relies on improper *legal* theories, it may be possible to adjudicate damages issues through pretrial motion practice. For example, when a party seeks the benefit of the entire market value rule without evidence that “the patented feature creates the basis for customer demand or substantially create[s] the value of the component parts” it may be possible (and advisable) to rule on the

issue prior to trial. See *Uniloc USA, Inc. v. Microsoft Corp.*, 632 F.3d 1292 (Fed. Cir. 2011). Similarly, where a party improperly relies on the “25% Rule” as a methodology to calculate a reasonable royalty, a court should consider ruling prior to trial on this issue. See *id.* at 1315 (holding as a matter of law that the 25% rule of thumb is a fundamentally flawed tool for determining a baseline royalty rate in a hypothetical negotiation, therefore evidence relying on that rule is inadmissible). A court should also consider ruling prior to trial on an improper application of the Nash Bargaining Solution in which a party fails to “sufficiently establish[] that the premises of the theorem actually apply to the facts of the case at hand,” because such a use would be an “inappropriate ‘rule of thumb.’” *VirnetX, Inc. v. Cisco Sys., Inc.*, 767 F.3d 1308, 1332–34 (Fed. Cir. 2014); see also *Robocast, Inc. v. Microsoft Corp.*, No. 10-1055-RGA, 2014 U.S. Dist. LEXIS 10745, 2014 WL 350062 (D. Del. Jan. 29, 2014) (ruling on application of Nash bargaining and reliance on licenses not technologically comparable); *Oracle Am., Inc. v. Google Inc.*, 798 F. Supp. 2d 1111 (N.D. Cal. 2011) (excluding conjoint analysis where the expert included three patented features among the seven studied features, failed to include important non-patented features among the seven tested features, and failed to provide any reasonable criteria for the selection).

6.2.2 Issues Less Amenable to Summary Judgment

The issues least amenable to summary judgment are typically those that have at least two of the following characteristics: (1) require a high burden of proof; (2) are questions of fact; (3) are broad issues requiring the movant to establish a wide range of facts; and (4) involve subjects about which the underlying facts are typically disputed.

For example, the contention that a patent claim is anticipated combines the high clear-and-convincing burden of proof with the requirement that the accused infringer establish that a single reference contains a disclosure of every limitation of the claim. This normally involves proving a wide range of facts in the face of vehement disagreement from the patentee, though of course in some cases anticipation may be an issue that is essentially resolved as a result of a broad claim construction. Infringement under the doctrine of equivalents has a different combination of characteristics: It is a factual question that requires the fact finder to draw inferences from the underlying facts, and the parties typically rely heavily on conflicting expert opinions about whether the differences between the claim limitation and asserted equivalent are insubstantial. Again, however, in some cases the doctrine of equivalents may be an issue that is essentially resolved as a result of a broad claim construction.

The equitable issues of laches and estoppel typically involve heavily disputed underlying facts. The invalidity defenses of enablement and written description combine a high burden of proof with the fact that the parties typically rely on conflicting expert testimony about what a person having ordinary skill in the art would have understood about the patent’s disclosure. As a result of these characteristics, these issues are less amenable to summary judgment.

Another issue generally less amenable to summary judgment is a claim of inequitable conduct. This is particularly true in light of the Federal Circuit’s en banc decision in *Therasense, Inc. v. Becton, Dickinson & Co.*, 649 F.3d 1276 (Fed. Cir. 2011). In *Therasense*, the court set forth heightened standards for both parts of the two-part standard for an inequitable conduct defense. To satisfy the first part, the accused infringer must show, by clear and convincing evidence, that the patentee “acted with the specific intent to deceive the [Patent Office].” *Id.* at 1290. In cases where the alleged misconduct was the nondisclosure of prior art, the accused infringer “must prove by clear and convincing evidence that the applicant knew of the [prior art] reference, knew that it was material, and made a deliberate decision to withhold it.” *Id.* To satisfy the second part of the test, the accused infringer must prove, by clear and convincing evidence, that the misconduct was “but-for” material. In the context of nondisclosure, but-for materiality means that “the [Patent Office] would not have allowed a claim had it been aware of the undisclosed prior art.” *Id.* at 1291. *Therasense* provides one exception to but-for materiality— “[w]hen the patentee has engaged in affirmative acts of egregious misconduct, such as the filing of an unmistakably false affidavit, the misconduct is material.” *Id.* at 1292.

Because the standard is high and the inquiry is fact-intensive, inequitable conduct can seldom be affirmatively established on summary judgment. A patentee, however, can more easily establish a lack of inequitable conduct on summary judgment in light of the heightened standard. For example, in the nondisclosure context, even where materiality and knowledge are established, the claim will not survive without evidence sufficient to draw the inference that the material was withheld with the specific intent to deceive the Patent Office—even high materiality is insufficient to give rise to an inference where there is no evidence of intent. *See, e.g., 1st Media, LLC v. Elec. Arts, Inc.*, 694 F.3d 1367, 1373–74 (Fed. Cir. 2012) (reversing a district court judgment of inequitable conduct following a bench trial, despite the district court’s finding that the withheld references were material and that the named inventor and his prosecution attorney knew that they were material, because there was “no direct evidence that [the inventor and prosecuting attorney] intended to deceive the PTO”). But where some evidence of the specific intent to deceive exists, particularly in the context of misrepresentations made to the Patent Office, an inequitable conduct defense may be difficult to resolve on summary judgment. *See, e.g., Ohio Willow Wood Co. v. Alps S., LLC*, 735 F.3d at 1350–51 (reversing summary judgment of no inequitable conduct where the record contained evidence sufficient to find but-for materiality of withheld material, where counsel repeatedly made false representations in arguments to Board of Patent Appeals and Interferences, and where the fact that the repeated misrepresentations were directly refuted by evidence in the attorneys’ possession was sufficient to support an inference of intent to deceive, but observing that “[w]e leave it to the district court to determine if the inference of deceptive intent that we hold could be drawn when viewing the evidence in a light most favorable to Alps remains after assessing the credibility of OWW’s witnesses”). Because the issue of intent turns on the credibility of witnesses, inequitable conduct is difficult to resolve on summary judgment absent a complete failure of proof as to one of the elements of the defense.

In a significant shift, willfulness is now also less amenable to summary judgment. As prior editions of this Guide explained, for nearly a decade courts applied the two-prong willfulness test set forth in *In re Seagate Technology, LLC*, 497 F.3d 1360 (Fed. Cir. 2007). To satisfy the first prong, *Seagate* required the patentee to prove by “clear and convincing evidence that the infringer acted despite an objectively high likelihood that its actions constituted infringement of a valid patent,” *Id.* at 1371. The Federal Circuit equated this prong with an “objective baselessness” standard, and “[i]f an objective litigant could conclude that the [defenses were] reasonably calculated to elicit a favorable outcome” they were not objectively baseless under § 285 and, for the same reason, *Seagate*’s objective test would not be satisfied.” *Bard Peripheral Vascular, Inc. v. W.L. Gore & Assocs., Inc.*, 682 F.3d 1003, 1007 (Fed. Cir. 2012). In short, if any of the defendant’s defenses were not baseless, willfulness failed as a matter of law, regardless of whether the patentee could satisfy the second (“subjective intent”) prong. This made willfulness very susceptible to summary judgment.

In 2016, the Supreme Court rejected the “unduly rigid” *Seagate* test in *Halo Electronics, Inc., v. Pulse Electronics, Inc.*, No. 14-1513, slip op. at 9-11, 15 (Supreme Court, June 3, 2016). In its place, the Court held that, like most aspects of patent litigation, willfulness requires proof by a preponderance of the evidence, not clear and convincing evidence. *Id.* at 12. And it embraced the AIA’s amendments to § 284 that bar patentees from relying on a defendant’s decision not to seek an opinion of counsel to prove willfulness. *Id.* at 14. Beyond these clear pronouncements, the Supreme Court provided only general guidelines about the standard for willfulness and enhanced damages, leaving much room for interpretation. For example, the Court delinked enhanced damages from willfulness by observing that willfulness is not a *per se* requirement for enhanced damages. At the same time, the Court observed that enhanced damages are generally appropriate only in egregious cases typified by willful misconduct. *Id.* at 11. Thus, willfulness will continue to play a central role in awarding enhanced damages. The Court did not identify what other factors might warrant enhanced damages, opening up leeway for litigants and district judges to flesh out appropriate circumstances.

As to the standard for awarding enhanced damages, the Court painted with broad strokes—damages should not be enhanced in “garden-variety” infringement cases and are “generally . . . reserved for egregious cases typified by willful misconduct,” but “none of this is to say that enhanced damages must follow a finding of egregious misconduct.” *Id.* at 11, 15. Although courts will need to work through the contours of these guidelines, what is clear is that the new standard is fact-intensive: “courts should continue to take into account the particular circumstances of each case in deciding whether to award damages, and in what amount.” *Id.* at 11. Given the fact-intensive nature of the inquiry, and—at least in the short term—the uncertainty about how these new guidelines should be applied, willful infringement is not well-suited for resolution by summary judgment in most cases.

Appendix 6.1

Sample Standing Order Setting a Schedule for First-Track Summary Judgment Motions

IN THE UNITED STATES DISTRICT COURT
FOR THE DISTRICT OF _____

COMPANY, INC.,

Plaintiff,

vs.

CASE NO. X

ANOTHER COMPANY, INC.,

Defendant.

STANDING ORDER RE: CLAIM CONSTRUCTION SCHEDULING

It is hereby **ORDERED** that the following deadlines are in effect for all patent infringement cases before the Court absent further order of this Court:

<p>80 days prior to CC hearing date</p>	<p>[N.D. Cal. Patent L.R. 4-3] Joint Claim Construction and Prehearing Statement due. Parties shall jointly submit a claim construction chart that sets forth construction of those terms on which the parties agree; each party’s proposed constructions of each disputed term, together with an identification of all references from the specification or prosecution history that each party contends support its construction; an identification of the terms whose construction will be most significant to the resolution of the case up to a maximum of 10.</p> <p>Notice of Intent to File Summary Judgment Motion Based On Claim Construction Due. A party that believes summary judgment can be granted based in whole or in primary part on the resolution of a claim construction dispute, and that wishes to file a motion for summary judgment to be heard in conjunction with claim construction, shall file a notice with the Court. The notice shall be no longer than 3 pages and shall (1) identify the claim construction dispute on which the summary judgment motion depends and (2) provide a brief summary of the party’s basis for believing that summary judgment can be granted based in whole or in primary part on resolution of that claim construction dispute. A party may not identify (or file) more than one summary judgment motion to be heard in conjunction with claim construction without leave of court. If a party wishes to obtain leave of court to file more than one motion, it must file a motion seeking leave no later than 30 days prior this deadline.</p>
---	---

65 days prior to CC hearing date	Motion for Summary Judgment Due. Any summary judgment motions to be heard with claim construction must be filed.
50 days prior to CC hearing date	[N.D. Cal. Patent L.R. 4-4] Discovery Deadline—Claim Construction Issues. The parties shall complete all discovery relating to claim construction, including any depositions with respect to claim construction of any witnesses, including experts.
45 days prior to CC hearing date	Discovery Deadline—Opposition to Summary Judgment with Claim Construction. The non-moving party shall complete all discovery relating to any summary judgment motion filed to be heard with claim construction, including any depositions of any witnesses, including experts, offering declarations in support of such summary judgment motions.
35 days prior to CC hearing date	[N.D. Cal. Patent L.R. 4-5(a)] Opening brief regarding claim construction due from party claiming patent infringement. Summary Judgment Opposition Due. Opposition brief due for any summary judgment motions to be heard with claim construction.
21 days prior to CC hearing date	[N.D. Cal. Patent L.R. 4-5(b)] Responsive brief regarding claim construction due from party defending against claim of patent infringement. Discovery Deadline—Summary Judgment with Claim Construction. The moving party shall complete all discovery relating to any summary judgment motion filed to be heard with claim construction, including any depositions of any witnesses, including experts, offering declarations in opposition to such summary judgment motions.
14 days prior to CC hearing date	Parties to file a notice with the Court stating the estimated amount of time requested for the claim construction hearing. The Court will notify the parties if it is unable to accommodate this request. [N.D. Cal. Patent L.R. 4-5(c)]—Reply brief regarding claim construction due from party claiming patent infringement. Summary Judgment Reply Due. Reply brief due for any summary judgment motions to be heard with claim construction.
CC hearing date	The Claim Construction Hearing set by the Court. The Court will hear any Motion for Summary Judgment filed in compliance with the deadlines in this Order in conjunction with the Claim Construction Hearing or shortly thereafter. The Court will notify the parties if the hearing will be separate from the Claim Construction Hearing.

Chapter 7

Pretrial Case Management

- 7.1 Pretrial Conference 2
 - 7.1.1 Timing 3
 - 7.1.2 Participation 3
 - 7.1.3 The Pretrial Order 3
 - 7.1.4 Motions at the Pretrial Conference 3
- 7.2 Trial and Disclosure Schedule 4
- 7.3 Jury Instructions 5
 - 7.3.1 Preliminary Instructions 5
 - 7.3.2 Final Instructions—Timing 6
 - 7.3.3 Final Instructions—Substance 6
 - 7.3.4 Final Instructions—Common Disputes 7
 - 7.3.4.1 Integration of Case-Specific Contentions 7
 - 7.3.4.2 Claim-Construction Instruction 7
 - 7.3.4.3 The “Presumption” of Validity Instruction 8
 - 7.3.4.4 The Obviousness Instruction 9
 - 7.3.4.4.1 Background: Pre-KSR Obviousness Law and Jury Instructions 10
 - 7.3.4.4.2 Post-KSR Obviousness Law and Jury Instructions 11
 - 7.3.4.5 Willfulness 14
 - 7.3.4.6 Inducement of Infringement 16
 - 7.3.4.7 Damages 17
 - 7.3.4.7.1 Royalty Base 19
 - 7.3.4.7.2 Royalty Rate 23
- 7.4 Substantive Limitations on Expert Testimony 23
 - 7.4.1 The Role of Experts in Patent Cases 24
 - 7.4.2 Timing and Procedure: When and How Should the Court Exercise Its Gatekeeping Role? 25
 - 7.4.3 Specific Substantive Limitations on Expert Testimony 27
 - 7.4.3.1 Improper Subject Matter 27
 - 7.4.3.1.1 State of Mind of Another Person, Usually an Inventor, Prosecutor, or Examiner 27
 - 7.4.3.1.2 Matters of Law 28
 - 7.4.3.2 Inadequate Qualifications 29
 - 7.4.3.3 Unreliable Analysis 29
 - 7.4.3.3.1 Conclusory Expert Opinions 30
 - 7.4.3.3.2 Unreliability of the Methodology or Its Application 32
 - 7.4.3.3.2.1 Misapplication of the *Georgia-Pacific* Factors 32
 - 7.4.3.3.2.1.1 Consideration of Factors Not Specified in *Georgia-Pacific* 33
 - 7.4.3.3.2.1.2 Selective Use of the GP Factors 34
 - 7.4.3.3.2.1.3 Use of an Incorrect Date for the Hypothetical Negotiation 34
 - 7.4.3.3.2.1.4 Use of Facts that Post-Date the Hypothetical Negotiation 34
 - 7.4.3.3.2.2 Use of an Incorrect Base for Damages 36
 - 7.4.3.3.2.3 Reliance on a Legally Insufficient Methodology 36
 - 7.4.3.3.2.4 Litigation Surveys 37
 - 7.4.3.4 Motions Seeking to Prevent Lay Witness Opinions and Expert Witness Fact Testimony 39
- 7.5 Managing Patent Trials through Motions *In Limine* 39
 - 7.5.1 Maintaining the Integrity of the Infringement/Validity Framework 40
 - 7.5.1.1 Motion to Bar a Comparison Between the Accused Product and an Embodying Product (or Between Prior Art and an Embodying Product) 41
 - 7.5.1.2 Motion to Bar Presentation of Embodying Products as Physical Exhibits 42
 - 7.5.1.3 Motion to Bar Evidence that the Accused Infringer Has Patents of Its Own 42
 - 7.5.1.4 Motion to Bar Argument that Patent Is Not Infringed Because It Is Invalid 43

7.5.2	Untimely Disclosures	43
7.5.2.1	Motion to Preclude Undisclosed Fact Witnesses	45
7.5.2.2	Motion to Preclude Undisclosed Prior Art	45
7.5.2.3	Motion to Preclude Untimely Expert Opinions	47
7.5.2.3.1	Opinions Not Disclosed in Reports	47
7.5.2.3.2	Affirmative Opinions Disclosed in Rebuttal Reports	48
7.5.2.3.3	Limit Experts to their Reports	48
7.5.3	Precluding Claims/Defenses	48
7.5.4	Miscellaneous Patent-Related Motions	50
7.5.4.1	Motion to Bar Evidence/Argument Inconsistent with Claim Construction	50
7.5.4.2	Motion to Preclude Reference to an Expert's Contrary Claim-Construction Opinion	51
7.5.4.3	Motion to Bar Evidence/Argument About Dropped Claims/Patents	52
7.5.4.4	Motion to Bar Disclosure that the Patentee Seeks an Injunction	52
7.5.4.5	Motion to Preclude Reference to Related Proceedings in the Patent Office	53
7.5.4.6	Motion to Preclude Evidence Concerning Undisclosed Opinions of Counsel	55
7.5.4.7	Motion to Preclude Evidence Based on Estoppel Resulting from Postgrant Proceedings	55
7.5.4.8	Motion to Preclude Reference to Presumption of Validity	56
7.5.4.9	Motion to Preclude Use of "Patent Troll" and Other Pejorative Terms Related to Nonpracticing Entities	57
Appendix 7.1	Sample Pretrial Order for Patent Cases	59
Appendix 7.2	Proposed Final Pretrial Order—Patent (Chief Judge Leonard P. Stark, District of Delaware)	63

Close judicial management of the preparations for trial is integral to ensuring smooth proceedings during trial. As discussed in previous chapters, early judicial management can help narrow the issues that require resolution by trial. There are many procedural and substantive issues that can be resolved in the weeks preceding trial to refine issues and avoid delay during trial. This chapter discusses the considerations that should be given to pretrial preparations to promote efficient proceedings during trial, with particular discussion of the patent case pretrial conference, jury instructions, limitations on expert testimony, and motions *in limine*. Note that in some cases sound case management may require that some issues be addressed well *before* the pretrial conference.

7.1 Pretrial Conference

The complexity of patent cases creates a particular need for pretrial preparation to minimize jury downtime and increase jury comprehension. The pretrial conference represents the final opportunity to anticipate and resolve problems that would otherwise interrupt and delay trial proceedings. Having an effective pretrial conference is best guaranteed by requiring counsel to confer on a series of issues and then identifying and briefing the areas of disagreement.

As will be apparent from the sample order that is provided as Appendix 7-1, most of these issues arise in any complex case. However, in patent litigation they can take on special dimensions. In this section, we explore the pretrial conference process.

7.1.1 Timing

The pretrial conference should be held sufficiently in advance of trial, but long enough after claim construction and dispositive motion practice so that the court and counsel have a good idea of the boundaries of the trial and the interplay of issues that may need to be tried. Usually, the conference is set six to eight weeks before trial.

7.1.2 Participation

Because of the importance of the issues to be determined at the pretrial conference, the court should conduct this proceeding in person rather than telephonically. Lead trial counsel should be required to attend.

7.1.3 The Pretrial Order

The objective of the pretrial conference is to generate an order that will govern the issues for trial and establish the ground rules for the conduct of the trial. Because of the special issues that often arise in patent cases, it is helpful to provide counsel in advance with a draft form of order that leaves blanks where appropriate, effectively providing a checklist of issues to consider. The form should include provisions that reflect the court's typical view on many aspects of the trial. However, counsel should be allowed to suggest deviations from those typical procedures where circumstances warrant.

7.1.4 Motions at the Pretrial Conference

Patent cases are characterized by large numbers of motions directed at excluding or limiting the use of evidence, including *Daubert* motions attacking expert opinions. It is common practice, and very sensible, to resolve such issues substantially in advance of trial so that the parties return with their presentations appropriately honed in accordance with the court's limiting orders. The sample pretrial order includes instructions for identifying and briefing *in limine* motions. Of course, circumstances may justify making additional such orders during the trial. Frequently, however, a great deal of delay and confusion can be avoided by making these determinations in advance. Even where the court determines that certain disputes are best resolved during trial, the briefing and arguments often help the court and the parties by distilling the issues before trial. This enables the court to evaluate the evidence in that context as it comes in and causes the parties to self-regulate during trial. Pretrial conferences can also produce the collateral benefit of settlement, by giving the parties a clearer picture of what evidence will or will not be accepted. The sections that follow provide detailed advice on the most frequent pretrial motions directed at expert testimony and other evidence.

7.2 Trial and Disclosure Schedule

Before any trial can begin, the court and the parties must settle on the schedule governing trial proceedings. While the overall trial schedule can be determined at the pretrial conference, the exact process and order of witnesses typically evolves during trial as a result of adjustments to evidence admitted, refused, or withdrawn, or one party responding to the emergent witness list of the other. The parties can and should be required to disclose well in advance of trial the universe of trial witnesses and trial exhibits that they may present and objections thereto. *See, e.g.*, Appendix 7.1 and Appendix 7.2 (requiring pretrial disclosure of will-call and may-call trial witnesses, trial exhibits, and objections). It is nevertheless impractical to finalize and commit the parties before trial to a fixed schedule identifying which of those witnesses and exhibits will actually be presented and the exact order in which they will occur. Likewise, while parties can and should be required to identify in advance which depositions they will or may use at trial, requiring the parties to identify weeks or months in advance of trial the *specific portions* of deposition testimony that they plan to present at trial is often inefficient—in typical cases, the parties spend vast amounts of time and money making deposition designations, counter-designations, and objections for *preservation* purposes in the pretrial stage. But these have little value because these designations cover broad swaths of testimony, and the parties redo them completely (selecting a much narrower set of testimony) once they decide, during trial, which designations to actually play. The court should, however, encourage the parties to stipulate to a protocol for disclosing the order in which witnesses will be called, the trial exhibits associated with each witness, and deposition designations during trial (collectively, “trial disclosures”).

Because the parties are in a better position to determine how much time is needed to finalize cross-examinations and objections to exhibits, the court should allow the parties to stipulate to a mutually agreeable schedule for trial disclosures (so long as it affords the court time to rule on objections). In a typical patent case, a one- or two-day advance disclosure of the witnesses and exhibits to be used on a specific day usually suffices. For example, a party intending to call a witness on Monday would disclose the witness and the exhibits to be used with the witness by a specified time on Saturday. The non-disclosing party would identify any objections to the exhibits by the next day. For deposition designations, a somewhat longer disclosure period (e.g., three or four days in advance) is usually warranted to allow sufficient time for counter-designations and resolution of objections. Whether more or less time is appropriate depends on the complexity of the particular case. These trial disclosures should notify the opposing party of the order in which previously identified trial witnesses and exhibits will be presented, not circumvent the court’s pretrial witness and exhibit disclosure requirements.

Any established trial disclosure protocol should also cover the disclosure of demonstrative exhibits that may be used with a particular witness. However, demonstratives should be disclosed with sufficient time to allow the opposing party to raise objections prior to the presentation to the jury. The court should also develop and share with the parties a default schedule for trial disclosures so that it can (1) avoid agreements that unduly burden the court (e.g., a deposition designation schedule

that does not afford the court a meaningful opportunity to resolve objections) and (2) impose that default schedule if the parties cannot agree.

7.3 Jury Instructions

7.3.1 Preliminary Instructions

Many jurors are called to service without much understanding of trial practice or the legal system. Usually, their understanding of the patent system is particularly limited. The problem is exacerbated because, unlike many other legal frameworks (such as negligence), principles of patent law often do not line up with jurors' moral or "common sense" reasoning, especially without explanation. For example, some find it illogical that a defendant can be liable even if it did not know about a patent. Some wrongly assume that a defendant's product cannot infringe the plaintiff's patent if the defendant has its own patent. Some believe that a device that was not patented cannot be "prior art" to a patent.

It is, therefore, good practice to give the jury preliminary instructions regarding their duties and the trial process before the start of trial. Providing the jurors with a legal framework before the presentation of evidence will help them understand what information they should consider once trial begins. Many of the available model jury instructions contain examples of useful preliminary instructions.¹ Preliminary instructions should, at a minimum, set forth the duty of the jury, explain what constitutes evidence, explain the varying burdens of proof in a civil trial, and outline trial proceedings. They should also include a non-argumentative description of the technology involved, the accused products, and the patents.

Because jurors usually understand the patent system even less than they understand the general legal system, it is important to provide the jury with a short explanation of the patent system, the particular patents at issue, and an overview of the patent law applicable to the contentions of the case. The Federal Judicial Center (FJC) has prepared a video that has often been used to provide a basic primer on the patent system. The video, together with a sample mock patent, is designed to be shown to prospective jurors in patent trials and provides background information on what patents are, why they are needed, how inventors get them, the role of the USPTO, and why disputes over patents arise.

The FJC updated the video in 2013 to address changes in patent law, including the enactment and implementation of the American Invents Act (AIA). This 2013 video, "The Patent Process: An Overview for Jurors," can be found here:

1. See, e.g., Benchbook for U.S. District Judges (Federal Judiciary Center 6th ed. 2014), § 6.06 Preliminary Jury Instructions in Civil Case; Fifth Circuit Pattern Jury Instructions—Civil (<http://www.lb5.uscourts.gov/juryinstructions/>); Eighth Circuit Manual of Model Jury Instructions (http://www.juryinstructions.ca8.uscourts.gov/civil_instructions.htm); Ninth Circuit Manual of Model Jury Instruction—Civil (http://www.akd.uscourts.gov/docs/general/model_jury_civil.pdf); Eleventh Circuit Pattern Jury Instructions—Civil (<http://www.ca11.uscourts.gov/documents/pdfs/civjury.pdf>).

<https://www.youtube.com/watch?v=ax7QHQTbKQE>. The original video, which had been used to educate patent juries for many years, is now out of date and should not be used. The 2013 video will be appropriate for most patent-infringement cases, but the court should confirm this in each case by discussing with the parties whether to play it. Given the rapid evolution of the substantive law in many areas, the court should also proactively inquire whether any aspects of the video that are relevant to the issues that the jury will be asked to decide are inaccurate or misleading in light of applicable law.

As an alternative to the FJC video, the court can address these issues in its preliminary instructions, for example by using preliminary instruction A.1 (“What A Patent Is and How One Is Obtained”) promulgated by the Northern District of California in its Model Patent Jury Instructions (June 14, 2014). These instructions can be found in Appendix E. *See also* Federal Circuit Bar Association, Model Patent Jury Instructions (January 2016) (contained in Appendix E). Preliminary instructions should also include an instruction setting forth the court’s construction of patent claim terms. The jurors should be instructed that they must accept the court’s constructions and are not allowed to construe terms on their own. *See Structural Rubber Prods. Co. v. Park Rubber*, 749 F.2d 707, 723 (Fed. Cir. 1984).

7.3.2 Final Instructions—Timing

In addition to preliminary instructions, the court should also instruct the jurors before they begin deliberations. While the court has discretion to instruct the jury before or after closing arguments are given, it is usually preferred to give instructions beforehand. Fed. R. Civ. P. 51, 1987 Advisory Committee Notes (delineating benefits of instructions before closing arguments). This is especially true in a patent case. Jurors are usually more focused and in a better position to listen to instructions before closing arguments. Jurors better understand the arguments advanced during the closings when they have been instructed on the law applicable to the case. Instructing the jury before closing arguments can also lead to more effective arguments by the parties. Closing arguments can be tailored to meet the specific language of the instructions, enabling the parties to highlight the significance of particular evidence. Thus, instructing the jury before closing argument is recommended.

If the jury will be instructed after closing argument, some of the benefits listed above can be retained if jury instructions are finalized before closing argument and provided to the parties. This allows the parties to tailor their closing arguments to the instructions that will be given, which is especially helpful to the jury. Thus, we recommend that the court finalize the instructions and provide them to the parties before closing arguments begin if the court chooses to instruct the jury after closing arguments.

7.3.3 Final Instructions—Substance

Patent law is complex, and so, typically, are jury instructions in patent cases. Fortunately, several organizations and courts have prepared model patent jury in-

structions. They serve as useful resources on which the parties can base their proposed instructions. *See* Appendix E. The model instruction sets differ stylistically. Moreover, the patent law has changed and continues to change in important ways, and at any given time some instructions may have been updated to reflect a recent Supreme Court or Federal Circuit decision while others may have not.

As a result, it generally makes sense to start from one of these sets of model instructions and modify or add to it as needed to address the issues in a particular case and the subsequent changes in law. One approach is for the court to select the set of model jury instructions it prefers and require the parties to prepare proposed instructions based on that set. This allows the court to become familiar with one set of instructions, while allowing the parties to propose changes based on changes in the law or the needs of the case. This approach has potential drawbacks, however, because some sets of model instructions do not address some issues, and as stated above, some sets of instructions will better reflect recent changes in the law. Another approach is to allow the parties to select which set of instructions makes the most sense to use as a model for a particular case.

The parties also often amend instructions to highlight the law particularly relevant to the arguments they intend to advance during trial. Allowing them to revise the model instructions to the particulars of the case can lead to argumentative and objectionable instructions, however. It is usually helpful to require the parties to submit “redlines” that show how they have revised the model instructions and provide any authority justifying their revisions.

7.3.4 Final Instructions—Common Disputes

Experience has shown that many of the same disputes over jury instructions arise repeatedly. This section discusses the most common disputes regarding jury instructions.

7.3.4.1 Integration of Case-Specific Contentions

Many disputes result from the integration of a party’s particular contentions into model jury instructions. Such particularized jury instructions may or may not be helpful to the jury. Generally, the court should attempt to exclude argumentative statements proposed by either side from the jury instructions. The “redline” mentioned above—which will show where any alterations have been made—is particularly helpful in avoiding this issue.

7.3.4.2 Claim-Construction Instruction

The instruction on claim construction is important and part of virtually every patent case. If the court has held a claim-construction hearing and issued a claim-construction order, those constructions should be restated as a jury instruction. The parties may not argue a contrary construction. One common problem is that, in an effort to preserve their claim-construction positions for appeal, parties will often re-

argue rejected claim constructions during the process of drafting jury instructions. This is inefficient. The court should streamline this process by instructing the parties to put the claim-construction order in the form of a jury instruction, and allowing them to reserve their objections to any constructions on the record. *See* § 5.1.6.

7.3.4.3 The “Presumption” of Validity Instruction

As most patent trials involve claims of invalidity, the patent owner will often try to incorporate into the instruction on invalidity a statement that patents are presumed to be valid. *See* 35 U.S.C. § 282. The defendant usually objects.

In 2011, the Supreme Court squarely addressed the question of the appropriate burden of proof for validity challenges in *Microsoft Corp. v. i4i Ltd. Partnership*, 131 S. Ct. 2238, 2251 (2011). In that case, the Court held that the “clear and convincing evidence” standard applied to all factual questions underlying the issue of invalidity, regardless of whether the United States Patent and Trademark Office (PTO) was aware of the prior art on which the validity challenge is based.

At the same time, the Court recognized that “if the PTO did not have all material facts before it, its considered judgment may lose significant force . . . And, concomitantly, the challenger’s burden to persuade the jury of its invalidity defense by clear and convincing evidence may be easier to sustain.” *Id.* at 2251. The Court noted that

although we have no occasion to endorse any particular formulation, we note that a jury instruction on the effect of new evidence can, and when requested, most often should be given. When warranted, the jury may be instructed to consider that it has heard evidence that the PTO had no opportunity to evaluate before granting the patent. When it is disputed whether the evidence presented to the jury differs from that evaluated by the PTO, the jury may be instructed to consider that question. In either case, the jury may be instructed to evaluate whether the evidence before it is materially new, and if so, to consider that fact when determining whether an invalidity defense has been proved by clear and convincing evidence.

Id. For this reason, where a defendant challenges the validity of a patent based on prior art that either (1) was not before the PTO or (2) was before the PTO but was not discussed or otherwise given substantive attention, the Court should consider instructing the jury that it may take this fact into consideration in evaluating whether the defendant has met the clear and convincing evidence standard. *See, e.g., AbbVie Deutschland GmbH & Co., KG v. Janssen Biotech, Inc.*, 759 F.3d 1285 (Fed. Cir. 2014) (finding acceptable an instruction explaining that the defendant’s burden may be easier to meet when the jury considers evidence of invalidity that is materially new, rephrasing the Supreme Court’s “materially new” as “additional information [that] would have been ‘material’ to the PTO’s decision to grant the patents,” stating that something is “material” if “there is a substantial likelihood that a reasonable patent examiner would consider it important in deciding whether to allow the application to issue as a patent,” and including the additional language that “if the additional information was not material, or it would not have carried significant weight, [the defendant’s] burden may be more difficult to meet”).

A concurrence from Justices Breyer, Scalia, and Alito emphasized that many invalidity disputes turn “not upon factual disputes, but upon how the law applies to facts as given.” *Id.*, 131 S. Ct. at 2253. The Justices pointed out that where questions of this nature arise (such as in questions about whether the facts show that the invention was novel and nonobvious) the clear and convincing standard “has no application.” *Id.* They noted further that:

Courts can help to keep the application of today’s “clear and convincing” standard within its proper legal bounds by separating factual and legal aspects of an invalidity claim, say, by using instructions based on case-specific circumstances that help the jury make the distinction or by using interrogatories and special verdicts to make clear which specific factual findings underlie the jury’s conclusions. *See* Fed. R. Civ. Proc. 49 and 51. By isolating the facts (determined with help of the “clear and convincing” standard), courts can thereby assure the proper interpretation or application of the correct legal standard (without use of the “clear and convincing” standard).

Id. Although this concurrence is not the opinion of the Court, it strongly suggests that courts should confine the applicability of the “clear and convincing” standard to factual questions and avoid their improper application to legal determinations.

Finally, it is also generally agreed that while juries should be instructed on the higher burden of proof required to prove invalidity, they should not be instructed that there is a presumption of validity, which would be redundant and likely confusing. As the National Jury Instruction Project explains: “In light of the procedural role of the presumption of validity, instructing the jury on the presumption in addition to informing it of the highly probable burden of proof may cause jury confusion as to its role in deciding invalidity.” Committee Note to National Jury Instruction Project, Model Patent Jury Instructions 5.1. In line with this approach, the Federal Circuit Bar Association’s Model Patent Jury Instructions, the Northern District of California Model Patent Jury Instructions and American Intellectual Property Law Association’s Model Patent Jury Instructions also omit any reference to the presumption of validity in their instructions. *See also Chiron Corp. v. Genentech, Inc.*, 363 F.3d 1247, 1258–59 (Fed. Cir. 2004) (finding district court did not err in declining to instruct jury on the presumption of validity because the jury had applied the clear and convincing evidence standard); *Avia Group Int’l, Inc. v. L.A. Gear Cal., Inc.*, 853 F.2d 1557, 1562 (Fed. Cir. 1988) (the presumption of validity “does not constitute ‘evidence’ to be weighed against a challenger’s evidence”).

7.3.4.4 The Obviousness Instruction

The Supreme Court’s decision in *KSR International Co. v. Teleflex, Inc.*, 550 U.S. 398 (2007), was a significant change in the law that has had a significant direct effect on jury instructions. *KSR* reversed the Federal Circuit’s requirement that the evidence contain a “teaching, motivation, or suggestion” to combine the prior art used to show obviousness. *KSR* emphasized the need for courts to apply an “expansive and flexible” common-sense approach in evaluating validity, rather than being constrained by the rigid requirement of “motivation to combine.” *Id.* at 415.

KSR also reemphasized the long-standing law that the question of obviousness is a legal question for the court. *Id.* at 426–27. Prior to KSR, the obviousness inquiry under § 103 was generally treated as secondary to the anticipation analysis under § 102, and was generally submitted to the jury for resolution along with anticipation. Often, the verdict form did not even separate the questions of obviousness and anticipation, including instead a single yes/no box for the question of validity. KSR’s insistence that obviousness was a legal determination for the court—one that should be made by the court when the obviousness of the claim is “apparent” even despite disputes about underlying facts—calls that practice into doubt. *Cf. Agrizap, Inc. v. Woodstream Corp.*, 520 F.3d 1337, 1343 n.3 (Fed. Cir. 2008) (“While a special verdict that asks a jury whether a patent claim is obvious provides more insight than one which simply asks whether the patent is invalid, the former still does not provide any detail into the specific fact findings made by the jury”); *see also Richardson-Vicks Inc. v. Upjohn Co.*, 122 F.3d 1476, 1484–85 (Fed. Cir. 1997) (noting that the “preferred route [to make a jury verdict on obviousness more amenable to appellate review] would have been to submit the underlying factual issues to the jury in the form of a special verdict under [R]ule 49(a)”; Paul J. Zegger et al., *The Paper Side of Jury Patent Trials: Jury Instructions, Special Verdict Forms, and Post-Trial Motions*, 910 PLI/PAT 701, 716 (2007) (“By compelling a jury to consider factual issues individually, special verdicts and interrogatories may improve the consistency of jury verdicts as well as the underlying decision-making processes that produce them.”). This is reflected, for example, in the Northern District of California’s model patent jury instructions, which provide two alternative model instructions on obviousness, one to be used when seeking an advisory verdict on the ultimate question of obviousness, and one to be used when only seeking resolution of the relevant factual questions. The AIPLA and FCBA model instructions have likewise been updated to reflect KSR, but were drafted to address only the situation in which the jury is asked to reach an advisory verdict on obviousness.

7.3.4.4.1 Background: Pre-KSR Obviousness Law and Jury Instructions

In *Graham v. John Deere*, 383 U.S. 1 (1966), the Supreme Court laid out the basic test for obviousness that remains the law today. It held that:

[u]nder § 103, the scope and content of the prior art are to be determined; differences between the prior art and the claims at issue are to be ascertained; and the level of ordinary skill in the pertinent art resolved. Against this background the obviousness or nonobviousness of the subject matter is determined. Such secondary considerations as commercial success, long felt but unsolved needs, failure of others, etc., might be utilized to give light to the circumstances surrounding the origin of the subject matter sought to be patented.

Id. at 17–18. These three factual predicates, along with the “secondary considerations,” are known as the *Graham* factors. Evaluation of each of the *Graham* factors is a question of fact.

Traditionally, the question of obviousness has been submitted to the jury with instructions to consider the *Graham* factors and reach a conclusion as to obviousness. An instruction on the “nexus” requirement for secondary considerations is also sometimes given. Secondary considerations only support nonobviousness (or, in the case of a contemporaneous invention, obviousness) if they are tied to the alleged invention (i.e., have a “nexus”). See *Ormco Corp. v. Align Tech., Inc.*, 463 F.3d 1299, 1311–12 (Fed. Cir. 2006) (holding that if the feature responsible for a claimed invention’s commercial success was in the prior art, that success is irrelevant for purposes of determining obviousness); *Dippin’ Dots, Inc. v. Mosey*, 476 F.3d 1337, 1345 (Fed. Cir. 2007) (same). Because “nexus” is a legal question, an alternative to a “nexus” instruction is the exclusion of “secondary considerations,” evidence not shown to have the required “nexus.”

7.3.4.4.2 Post-KSR Obviousness Law and Jury Instructions

Since KSR emphasized that obviousness is a legal determination for the court, the Federal Circuit has exhibited a much greater proclivity to find patents invalid under § 103. See *Allergan, Inc. v. Apotex, Inc.*, 754 F.3d 952 (Fed. Cir. 2014) (finding both patents-in-suit obvious and reversing district court’s bench trial determination of nonobviousness); *Novo Nordisk A/S v. Caraco Pharm. Labs., Ltd.*, 719 F.3d 1346 (Fed. Cir. 2014) (affirming district court’s bench trial determination of obviousness, reversing on other grounds); *I/P Engine, Inc. v. AOL, Inc.*, 576 F. App’x 982, (Fed. Cir. 2014) (reversing district court’s post-jury-trial determination that asserted claims were nonobvious) (unpublished); *Tokai Corp. v. Easton Enters., Inc.*, 632 F.3d 1358 (Fed. Cir. 2011) (affirming summary judgment of obviousness); *Odom v. Microsoft Corp.*, 429 F. App’x 967 (Fed. Cir. 2011) (affirming summary judgment of obviousness) (unpublished); *Bayer Schering Pharma AG v. Barr Labs, Inc.*, 575 F.3d 1341 (Fed. Cir. 2009) (affirming finding of obviousness after bench trial); *In re Trans Tex. Holdings Corp.*, 498 F.3d 1290 (Fed. Cir. 2007); *Pharmastem Therapeutics, Inc. v. Viacell, Inc.*, 491 F.3d 1342 (Fed. Cir. 2007) (reversing denial of judgment as a matter of law (JMOL) to find obviousness); *Leapfrog Enters., Inc. v. Fisher-Price, Inc.*, 485 F.3d 1157 (Fed. Cir. 2007) (affirming finding of obviousness after bench trial); *In re Icon Health & Fitness, Inc.*, 469 F.3d 1374 (Fed. Cir. 2007); *Frazier v. Layne Christensen Co.*, 239 F. App’x 604 (Fed. Cir. 2007) (affirming JMOL of obviousness) (unpublished).

It is the court’s responsibility to reach a conclusion on the ultimate issue of obviousness. However, any obviousness finding requires that the fact finder consider all of the “objective evidence presented by the patentee.” *WMS Gaming Inc. v. Int’l Game Tech.*, 184 F.3d 1339, 1359 (Fed. Cir. 1999); see also *Rothman v. Target Corp.*, 556 F.3d 1310, 1322 (Fed. Cir. 2009) (approving district court’s charge “that the jury ‘must consider’ objective indicia of nonobviousness, such as . . . licensing activity”). The renewed emphasis on the role of the court casts doubt on the practice of submitting the ultimate question of obviousness to the jury. It may now be better practice to limit the jury’s consideration of obviousness to the factual disputes as to the *Graham* factors, as reflected in the Northern District of California Model Patent Jury Instruc-

tion 4.3b (Alternative 1) and Sample Verdict Form § F (Alternative 1). See Appendix E.

Of course, courts remain free to seek an advisory verdict from the jury. The Northern District of California Model Patent Jury Instruction 4.3b (Alternative 2) and Sample Verdict Form § F (Alternative 2) provide this option. If the traditional advisory verdict approach is taken, however, courts should not rely on pre-*KSR* jury instructions. *KSR* criticized pre-2007 Federal Circuit decisions in the area of obviousness and effected a substantial change in the law. Both the Northern District of California and Federal Circuit Bar Association Model Patent Jury Instructions have been updated to reflect the *KSR* decision. Another is the Patent Office's detailed set of guidelines describing how to evaluate obviousness under *KSR*. 72 Fed. Reg. 57526-57535 (Oct. 10, 2007). These guidelines explain the law in a more operational manner and provide seven different rationales that can be used to support a finding of obviousness as well as the factual elements needed to support each of the seven rationales. They also provide examples of actual cases finding obviousness under each of the seven rationales. See § 14.3.5.3.5 (Tables 14.5–14.8) (reproducing the PTO's charts). While the Patent Office's guidelines cannot be directly used as jury instructions, they are a useful resource for crafting instructions. Whatever instruction is adopted, it needs to reflect *KSR*'s mandate that an “expansive and flexible” approach be employed.

If the advisory verdict approach is taken, courts should carefully consider the structure of the verdict form. If the verdict form merely asks for the final conclusion on obviousness without specifying its underlying factual determinations, it can be difficult or impossible to understand what the advisory verdict implies. This can hinder the court's ability to perform its duty of reaching a conclusion regarding obviousness. Moreover, it can easily create a need for a new trial, especially if the jury's decisions on the *Graham* factors (the factual underpinnings of obviousness) cannot be discerned from the verdict. See, e.g., *Agrizap, Inc. v. Woodstream Corp.*, 520 F.3d 1337, 1343 n.3 (Fed. Cir. 2008); see also *Wyers v. Master Lock Co.*, 616 F.3d 1231, 1248 (Fed. Cir. 2010) (Linn, J. concurring) (“To facilitate review and reveal more clearly the jury's underlying factual findings, this Court has encouraged trial court judges to provide juries with special interrogatories on obviousness.”). This risk is mitigated, however, by the court's general practice when faced with a verdict in which the jury was not asked to answer special interrogatories. The court presumes the existence of factual findings necessary to support the jury's verdict. See *Wyers*, 616 F.3d at 1248 (Linn, J., concurring).

Our review of a general verdict on obviousness thus entails two steps. We first presume that the jury resolved the underlying factual disputes in favor of the verdict winner and leave those presumed findings undisturbed if they are supported by substantial evidence. Then we examine the legal conclusion de novo to see whether it is correct in light of the presumed jury fact findings.

Id. (quotations omitted); see also *Kinetic Concepts, Inc. v. Smith & Nephew, Inc.*, 688 F.3d 1342, 1367 (Fed. Cir. 2012) (“Significantly, whether there is a reason to combine prior art references is a question of fact . . . [and] [i]n light of the jury's verdict, we must assume that it determined there was no reason to combine the prior art refer-

ences, and we must defer to this factual finding because it is supported by substantial evidence.”).

In *Kinetic Concepts*, the Federal Circuit applied this framework to review the district court’s grant of judgment as a matter of law (JMOL) of obviousness. 688 F.3d at 1356–57. There, the parties disputed the form and content of the verdict form and the district court created a verdict form consisting of yes-or-no questions regarding the *Graham* factors, a chart pertaining to whether secondary considerations were present, and a question on the ultimate question of obviousness. *Id.* at 1354. Despite submitting the obviousness question to the jury, the judge stressed that the jury’s final determination would only be “advisory.” *Id.* at 1357. The jury subsequently determined that (1) there were other differences between the claims and the prior art in addition to those listed, (2) most of the objective considerations favoring nonobviousness were present, (3) infringement was proven, and (4) the asserted patents were not obvious. *Id.* at 1354. The district court, however, found the asserted claims obvious and granted the defendant’s motion for JMOL. In so doing, the district court gave the jury’s “advisory” determination of nonobviousness no deference. *Id.* at 1355–56.

The Federal Circuit reversed, noting that the court must presume that the jury resolved the underlying factual disputes in favor of the verdict, “leave those presumed findings undisturbed if . . . supported by substantial evidence,” and then examine the district court’s legal conclusion of obviousness *de novo*. *Id.* at 1356–57 (internal citation omitted). Importantly, even though the jury was specifically asked to decide certain factual issues and not others, the existence of the advisory verdict on the ultimate question of obviousness requires the court to presume that the jury found for the patentee on all underlying factual issues that it did *not* explicitly decide. Thus, when examining the legal conclusion of obviousness, the court must consider the jury’s explicit *and* implicit factual findings.

The Federal Circuit also rejected the defendant’s claim that the “advisory” status of the jury’s verdict on the ultimate question of obviousness affected the presumed factual findings. It held instead that, in this context, “advisory” simply meant that the jury resolved a legal issue for the court, which is permissible because the judge remains the ultimate arbiter of obviousness through the drafting of the jury’s legal instructions and the consideration of motions for a judgment notwithstanding the verdict or new trial. *Id.* at 1357–59. After gathering the jury’s explicit and implicit findings, the Federal Circuit reexamined the ultimate nonobviousness conclusion *de novo* and held that the district court erred in granting Smith & Nephew’s motion for JMOL because Smith & Nephew did not prove that the asserted claims were obvious. *Id.* at 1371.

The question of obviousness is often essential to the judgment. Unless the evidence meets the JMOL standard for finding obviousness or nonobviousness, resolution of the underlying factual disputes is necessary, and each party has a right to have a jury resolve such disputes if they are material. The losing party at trial will typically seek JMOL on the issue of obviousness, which joins the issue of how the jury resolved the material underlying factual disputes. If the court then draws conclusions about how the underlying factual disputes were resolved, it runs the risk of having

those conclusions challenged on Seventh Amendment grounds. Consider also the scenario where a jury finds that there is anticipation and obviousness, and either the district court or the Federal Circuit reverses the finding of anticipation because a specific limitation in one claim is not present in one of the references. At this point, with a single-question verdict form, it is not clear whether the jury's error on anticipation affects its conclusion as to obviousness. Avoiding these situations, as well as helping the court perform its duty of drawing a legal conclusion as to obviousness, are good reasons for the recommendation in the Northern District of California's model verdict form that "the verdict form should require the jury's finding on each factual issue so that the trial judge may make the final determination on the obviousness question." See Appendix E.

Requiring the jury to make specific findings on the *Graham* factors does, however, have drawbacks. The most serious is that it is likely to lead to a complex verdict form. This is apparent from the Northern District of California's model verdict form. Some courts may find that such a verdict form is simply too complex to be practicable, notwithstanding the risks discussed above.

Certainly, if a form like the Northern District of California's form is used, it needs to be available to the parties before closing to give them the opportunity to tell the jury how their arguments and positions connect to the verdict form. Asking only about the factors where the court believes there is a *material* dispute can simplify the verdict form used to ask the jury to make specific findings as to the *Graham* factors. While this could simplify the form, it poses the same risk of a new trial described above. It may be better simply to urge the parties to reach agreement on what the material disputes are. This is the approach contemplated by the Northern District of California's model form.

7.3.4.5 Willfulness

Proving willful infringement has long played a significant role in patent litigation. The Federal Circuit had long held that such proof served as a trigger for enhanced damages and award of attorneys' fees. The Supreme Court's decisions in *Octane Fitness LLC v. Icon Health & Fitness Inc.*, 134 S. Ct. 1749 (2014), and *Halo Electronics, Inc., v. Pulse Electronics, Inc.*, No. 14-1513 (Supreme Court June 3, 2016), loosened, although did not entirely dislodge, that connection. The ramifications for case management remain in flux, although some aspects of the analysis are clearer.

The *Halo* decision reshaped the contours of enhanced damages law. In rejecting the Federal Circuit's "unduly rigid" two-prong test for determining that the Federal Circuit adopted in *In re Seagate Technology, LLC*, 497 F.3d 1360 (Fed. Cir. 2007), the Supreme Court grounds the enhanced damages inquiry in equitable remedies jurisprudence dating back to the nineteenth century. See *Tilghman v. Proctor*, 125 U.S. 136, 143–144 (1888) (characterizing enhanced damages as "vindictive or punitive"); *Topliff v. Topliff*, 145 U.S. 156, 174 (1892) (infringer knowingly sold copied technology of his former employer); *Cincinnati Siemens-Lungren Gas Illuminating Co. v. Western Siemens-Lungren Co.*, 152 U.S. 200, 204 (1894) (requiring some showing of wanton or willful conduct). The Court noted that § 284 "contains no explicit limit or

condition” on the award of enhanced damages. The statute merely states that the court “may increase the damages up to three times the amount found or assessed.” The Court emphasized the centrality of the trial court’s discretion.

In so doing, the Supreme Court noted that subjective bad faith alone could warrant award of enhanced damages. The Federal Circuit’s second prong of “objective recklessness” unduly limits the trial court’s discretion. At the same time, the Court cautioned that “the channel of discretion [for enhanced damages] ha[s] narrowed” over the past two centuries, *Halo*, 579 U.S. at ___ (quoting Friendly, *Indiscretion About Discretion*, 31 Emory L.J. 747, 772 (1982)), with the result that “such damages are generally reserved for egregious cases of culpable behavior.” *Id.* Thus, damages should not be enhanced in “garden-variety” infringement cases. They are “generally ... reserved for egregious cases typified by willful misconduct,” such as “deliberate or wanton” infringement, “malicious pira[cy],” or objective recklessness. Nonetheless, willfulness is not a per se requirement for enhanced damages and enhanced damages need not follow a finding of egregious misconduct. “[C]ourts should continue to take into account the particular circumstances of each case in deciding whether to award damages, and in what amount.” *Id.* Willful infringement must be proven by a preponderance of evidence, *id.* at 12, and usually is based on the infringer’s knowledge and conduct at the time of infringement, not, for example, the merit of arguments later asserted in litigation, *id.* at 10.

Although the Supreme Court did not expressly address whether there remains any role for the jury in the determination of enhanced damages, the Federal Circuit held in *WBIP, LLC v. Kohler Co.*, ___ F.3d ___ (Fed. Cir. July 19, 2016), that “[w]e do not interpret [the Supreme Court’s decision in *Halo*] as changing the established law that the factual components of the willfulness question should be resolved by the jury.” Several of the factors affecting that discretion turn on historical factual predicates that could be disputed.

The *Halo* decision leaves no doubt that the ultimate exercise of discretion is for the trial judge. Thus, even if a jury finds willful infringement, the court may still decide that the conduct is not sufficiently egregious to warrant enhancement of damages. See *WBIP, LLC*, ___ F.3d at ___, n.13. Furthermore, the amount of any enhancement is for the district judge to decide.

Whether an advisory verdict on willfulness is appropriate (or even helpful to the court), and if so, what guidance to give the jury in making such a determination, remains an open question. But a jury’s responses to special interrogatories on underlying issues—for example, whether the defendant’s conduct falls within accepted norms in the industry, whether and when the defendant learned of the patent before the lawsuit, and whether the defendant believed in good faith that it did not infringe or the patent was invalid—may in many cases help the court exercise its discretion. Parties will no doubt disagree about the utility and content of such special interrogatories and the instructions that accompany them in many cases.

One further observation bears mention. Balancing providing clear instructions to (and questions for) the jury, on the one hand, with preventing substantial prejudice to the accused infringer, on the other hand, can be difficult. The *Halo* decision is likely to exacerbate this tension. If the court permits the patentee to present willful-

ness generally, or the facts underlying willfulness, to the jury, it may well be that the simplest and most effective way to balance these issues fairly is to phase or bifurcate willfulness such that it is tried after a jury has reached a verdict on liability.

7.3.4.6 Inducement of Infringement

In 2011, the Supreme Court resolved a long-standing ambiguity in indirect infringement law when it held that “induced infringement under § 271(b) requires knowledge that the induced acts constitute infringement” of the asserted patent. *Global-Tech Appliances, Inc. v. SEB S.A.*, 131 S. Ct. 2060, 2068 (2011). This decision harmonizes the required mental states for both forms of indirect infringement—inducement under § 271(b) and contributory infringement under § 271(c). *Id.* at 2067–68 (discussing its prior decision in *Aro II* and holding that § 271(b) and (c) require the “same knowledge”); *Aro Mfg. Co., Inc. v. Convertible Top Replacement Co., Inc. (Aro II)*, 377 U.S. 476 (1964) (“[Section] 271(c) does require a showing that the alleged contributory infringer knew that the combination for which his component was especially designed was both patented and infringing.”). This standard requires proving that the alleged infringer had a specific intent to induce acts it knew would infringe the asserted patent, as opposed to simply having the intent to induce acts that happen to infringe. The Supreme Court also recognized that the accused infringer, therefore, cannot induce infringement unless it knew of the patent. *Global-Tech*, 131 S. Ct. at 2068.

In reaching this result, the Supreme Court expressly rejected the standard set forth in *DSU Medical Corp. v. JMS Co.*, 471 F.3d 1293 (Fed. Cir. 2006) (en banc). In reviewing the district court decision underlying *Global-Tech*, the Federal Circuit found that “Pentalpha deliberately disregarded a known risk that SEB had a protective patent,” and that this was sufficient to satisfy *DSU*’s “knew or should have known” standard. *Global-Tech*, 131 S. Ct. at 2064–65. But the Supreme Court made clear that this standard is not viable: “deliberate indifference to a known risk that a patent exists is not the appropriate standard under § 271(b).” *Id.* at 2068 (describing “should have known” as a simple negligence standard); see also *Commil USA, LLC v. Cisco Sys., Inc.*, 720 F.3d 1361, 1367–68 (Fed. Cir. 2013) (vacating induced infringement verdict where jury instruction included improper language that the jury could find inducement where Cisco “should have known that its actions would induce actual infringement”).

In situations where an accused infringer is alleged to have deliberately avoided knowledge of the patent, the Supreme Court found that the appropriate touchstone is the doctrine of “willful blindness.” This doctrine varies somewhat between circuits, but all formulations contain “two basic requirements: (1) the defendant must subjectively believe that there is a high probability that a fact exists and (2) the defendant must take deliberate actions to avoid learning of that fact.” *Global-Tech*, 131 S. Ct. at 2070.

Regarding requisite specific intent, the Federal Circuit commented that “it is clear that a good-faith belief of noninfringement is relevant evidence that tends to show that an accused inducer lacked the intent required to be held liable for induced

infringement.” *Commil*, 720 F.3d at 1367–68. The same standard does not, however, apply to a good-faith belief that a patent is invalid. In *Commil USA, LLC v. Cisco Systems, Inc.*, 135 S. Ct. 1920 (2015), the Supreme Court ruled that because induced infringement and validity are separate issues and have separate defenses under the Patent Act, belief regarding validity cannot negate § 271(b)’s scienter requirement of “actively induce[d] infringement.” Otherwise, the Act’s presumption of validity, § 282(a), would be undermined, permitting circumvention of the high bar—the clear and convincing standard—that defendants must surmount to rebut the presumption.

It is also worth noting that in amending the law governing the use of legal opinions, the AIA not only prevents plaintiffs from using the lack of a legal opinion to show willfulness, but also prevents plaintiffs from arguing that the lack of a legal opinion can be used “to prove . . . that the infringer intended to induce infringement of the patent.” § 298. Thus, the absence of an opinion cannot be used to infer the “specific intent” necessary to support a claim of inducing infringement.

Further, *see* § 6.2.1.2.6, where an accused infringer does not itself perform all the steps of an accused method, it cannot be liable for infringement unless it controls or directs performance of each step of the accused method. *Muniauction, Inc. v. Thomson Corp.*, 532 F.3d 1318 (Fed. Cir. 2008) (reversing a jury verdict of infringement). “There can only be joint infringement when there is an agency relationship between the parties who perform the method steps or when one party is contractually obligated to the other person to perform the steps.” *Akamai Techs., Inc. v. Limelight Networks, Inc.*, 629 F.3d 1311, 1320 (Fed. Cir. 2010), *rev’d on other grounds*, 692 F.3d 1301 (Fed. Cir. 2012) (en banc) (per curiam), *rev’d*, 134 S. Ct. 2111 (2014). And “a defendant is not liable for inducing infringement under § 271(b) when no one has directly infringed under § 271(a) or any other statutory provision.” *Limelight Networks, Inc. v. Akamai Techs., Inc.*, 134 S. Ct. 2111 (2014).

The Northern District of California model jury instructions and the Federal Circuit Bar Association 2016 model jury instructions have been updated to reflect the Supreme Court’s decisions in *Global-Tech* and *Akamai*. The Federal Circuit Bar Association’s 2016 instructions have also been updated to reflect the Supreme Court’s decision in *Commil*.

7.3.4.7 Damages

One of the most vexing issues in patent law is the proper measure of damages. Crafting an appropriate jury instruction on compensatory damages for patent infringement is difficult. The first paragraph of § 284 provides that “the court shall award the claimant damages *adequate to compensate* for the infringement but in no event less than a reasonable royalty for the use made of the invention by the infringer . . .” (emphasis added). Thus, this provision aims to put the patent holder in the financial position it would have enjoyed but for the infringement. It calls for the court to determine the patent holder’s lost profits. As the Supreme Court has stated, the question to be asked is: “Had the infringer not infringed, what would the patent holder . . . have made?” *Aro II*, 377 U.S. at 507; *see also Pall Corp. v. Micron Separations, Inc.*, 442 U.S. 57, 63 (1979).

tions, Inc., 66 F.3d 1211, 1223 (Fed. Cir. 1995) (“the purpose of compensatory damages is not to punish the infringer, but to make the patentee whole”);² *State Indus., Inc. v. Mor-Flo Indus., Inc.*, 883 F.2d 1573, 1577 (Fed. Cir. 1989) (damages shall compensate the patentee for its pecuniary loss because of the infringement).

Depending on the circumstances, a patentee’s compensatory damages can include: lost direct sales; price erosion (lost profits resulting from the lower price resulting from competition from the infringer); increased costs; and lost “convoys sales”—parts, accessories, and repair or maintenance services that are functionally related to the patented products. See generally § 14.4.3.2. The Federal Circuit has developed exacting standards of proof for lost profits. To establish lost sales, the patent holder must ordinarily prove demand for the patented product, absence of acceptable noninfringing substitutes, manufacturing and marketing capability to exploit the demand, and the amount of per-unit profit. See *Rite-Hite Corp. v. Kelley Co.*, 56 F.3d 1358, 1545 (Fed Cir. 1995) (en banc) (endorsing the test articulated in *Panduit Corp. v. Stahl Bros. Fibre Works, Inc.*, 575 F.2d 1152 (6th Cir. 1978)).

Owing to relatively strict standards of proof, lost profits can be difficult to establish in practice. Moreover, some entities cannot prove lost sales. Their injury is better characterized as lost licensing revenue. Thus, as an alternative to determining lost profits, § 284 sets a floor for compensatory damages: “in no event [shall the compensatory award be] less than a reasonable royalty for the use made of the invention by the infringer.”

In recent years, reasonable royalty jurisprudence has developed rapidly. Analyzing a hypothetical negotiation is the most common, although not the only, way to determine a reasonable royalty. In a typical case, the parties will put forward economic experts to opine on the payment that would have resulted from a hypothetical arms-length negotiation between the patent holder and the infringer prior to the infringing activity. The hypothetical negotiation is based on the assumptions that the patent was valid, would be infringed by the defendant’s conduct, and the parties were truly willing and able to negotiate a license. Most often, this testimony examines the wide range of factors set forth in *Georgia-Pacific Corp. v. U.S. Plywood Corp.*, 318 F. Supp. 1116 (S.D.N.Y. 1970).³

In theory, reasonable royalty testimony should establish three items: (1) the date of the hypothetical negotiation and when the royalty obligation begins; (2) the royalty base; and (3) the royalty rate per unit (or lump sum amount, where appropriate).⁴

2. Pecuniary damages are not meant to punish for infringement because treble damages are available for punishing willful infringement.

3. Not all *Georgia-Pacific* factors apply in every case. In *Ericsson, Inc. v. D-Link Systems, Inc.*, 773 F.3d 1201, 1235 (Fed. Cir. 2014), in a case involving a RAND-encumbered patent, the Federal Circuit noted that “a district court must instruct the jury only on factors that are relevant to the specific case at issue.” “There is no *Georgia-Pacific*-like list of factors that district courts can parrot for every case involving RAND-encumbered patents.” *Id.*

4. Not all royalty agreements require a rate per unit sold. Some royalty agreements require a fixed payment per unit of time. Such agreements trade flexibility for a guaranteed income stream. They can also be easier to administer and audit. In some fields, such

The jury instruction regarding the date of the hypothetical negotiation is usually relatively straightforward. The royalty base and royalty rate instructions have generated substantial controversy because of concerns about the reliability of economic experts' analysis and juror comprehension.

7.3.4.7.1 Royalty Base

One common dispute concerns the royalty base against which the royalty rate is applied. In cases in which the patented technology represents the primary basis for demand for the defendant's infringing product, such as a pharmaceutical case in which the patent claims a new drug, the reasonable royalty appropriately extends to the accused product's entire revenue. In cases where the patent covers only one component of a multicomponent product, such as one feature of a complex micro-computer, the reasonable royalty determination requires more scrutiny to ensure that the damage award measures the harm to the patent holder attributable to the infringing component or feature and not the contribution from other components of the product, the defendant's good will in the marketplace, and other factors unrelated to the patent. "Where small elements of multi-component products are accused of infringement, calculating a royalty on the entire product carries a considerable risk that the patentee will be improperly compensated for non-infringing components of that product." *LaserDynamics, Inc. v. Quanta Computer, Inc.*, 694 F.3d 51, 67 (Fed. Cir. 2012). Indeed, even where a patentee bases the royalty on the "smallest salable patent-practicing unit," there may still need to be further constraint on the selection of the base. *VirnetX, Inc. v. Cisco Sys., Inc.*, 767 F.3d 1308, 1327 (Fed. Cir. 2014) (holding that where the smallest salable unit is a multicomponent product containing several noninfringing features, the patentee must do more to estimate what portion of the value of that product is attributable to the patented technology). Instead, the requirement that the patentee identify damages associated with the smallest salable patent-practicing unit is simply a step toward meeting the requirement of apportionment. *Id.*

The "entire market value rule" is a "narrow exception" to the general rule. When claims are drawn to an individual component of a multicomponent product, it is the exception, not the rule, that a patentee can recover "damages as a percentage of revenues or profits attributable to the entire product." The exception applies only when the patentee can show that the "patented feature drives the demand for an entire multi-component product." *LaserDynamics*, 694 F.3d at 67-68 (holding that *LaserDynamics*' use of the entire market value rule was impermissible where patentee did not show that the patented method drove demand for the entire product and that it was not enough to merely show that the method is valuable, important, or even essential to the entire product). "The entire market rule allows for the recovery of damages based on the value of an entire apparatus containing several features, when the feature patented constitutes the basis for customer demand." *Lucent*

agreements are more common and may provide the basis for an alternative royalty rate calculation.

Techs., Inc. v. Gateway, Inc., 580 F.3d 1301 (Fed. Cir. 2009) (quoting *TWM Mfg. Co. v. Dura Corp.*, 789 F.2d 895, 901 (1986)) (finding that a \$358 million damages award was not supported by substantial evidence and remanding for new trial).

Even in cases in which the accused device incorporates many components beyond the patented technology, patent holders will typically advocate using the entire market value of the defendant's product as the baseline for the reasonable royalty determination. They typically request a general instruction indicating that the patent holder is entitled to a reasonable royalty based on the list of *Georgia-Pacific* factors. *Georgia-Pacific* Factor 13 expressly considers the value of other components in the accused device to the overall market value of the accused device: "The portion of the realizable profit that should be credited to the invention as distinguished from non-patented elements, the manufacturing process, business risks, or significant features or improvements added by the infringer." *Georgia-Pacific Corp. v. U.S. Plywood Corp.*, 318 F. Supp. 1116, 1120 (S.D.N.Y. 1970) (Factor 13). However, simply relegating this important issue to a long list of factors risks placing undue importance on the patented technology in suit relative to the value of other components in the accused device. Essentially, this approach provides the jury with little genuine guidance about how to resolve the battle of the economic experts and can lead to results that defy the economic logic that undergirds real-world licensing negotiations.

In weighing Factor 13, the *Lucent* court observed that "numerous features other than the [accused feature] appear to account for the overwhelming majority of the consumer demand and therefore significant profit." *Lucent*, 580 F.3d at 1333. Consequently, "[t]he only reasonable conclusion that can be drawn" from the factual evidence presented at trial is that the accused feature "is a minor aspect of a much larger software program and that the portion of the profit that can be credited to the infringing use of the [accused feature] is exceedingly small." *Id.*

Further, in *LaserDynamics*, the Federal Circuit emphasized that "the requirement to prove that the patented feature drives demand for the entire product may not be avoided by the use of a very small royalty rate." *LaserDynamics*, 694 F.3d at 67; see also *Uniloc USA, Inc. v. Microsoft Corp.*, 632 F.3d 1292, 1318–21 (Fed. Cir. 2011).

Moreover, "[r]egardless of the chosen royalty rate, one way in which the error of an improperly admitted entire market value rule theory manifests itself is in the disclosure of the revenues earned by the accused infringer associated with a complete product rather than the patented component only." *LaserDynamics*, 694 F.3d at 68 (referring to *Uniloc*, where the disclosure of a \$19 billion damages theory based on the entire market value caused unfair prejudice). "Admission of such overall revenues, which have no demonstrated correlation to the value of the patented feature alone, only serve to make a patentee's proffered damages amount appear modest by comparison, and to artificially inflate the jury's damages calculation beyond that which is 'adequate to compensate for the infringement.'" *Id.* It is also important, therefore, to take care to avoid misleading the jury by placing undue emphasis on the value of the entire product, over the value of the infringed feature.

To ensure that the jury appreciates the narrow "entire market value rule" exception, the Court should educate the jury about the importance of evaluating the rela-

tionship between the accused feature and other aspects of the commercial product or service in its instructions in determining the value of that feature. The Northern District of California Model Patent Jury Instructions provide a helpful example. The Model Instruction that explains a reasonable royalty states in relevant part:

If the patent covers only part of the product that the infringer sells, then the base would normally be only that feature or component. For example, if you find that for a \$100 car, the patented feature is the tires which sell for \$5, the base revenue would be \$5. However, in a circumstance in which the patented feature is the reason customers buy the whole product, the base revenue could be the value of the whole product. Even if the patented feature is not the reason for customer demand, the value of the whole product could be used if, for example, the value of the patented feature could not be separated out from the value of the whole product. In such a case, however, the rate resulting from the hypothetical negotiation would be a lower rate because it is being applied to the value of the whole product and the patented feature is not the reason for the customer's purchase of the whole product.

N.D. Cal. Model Patent Jury Inst. 5.7 (“Reasonable Royalty—Definition”) (June 17, 2014) (see Appendix E).

The most recent version of the Federal Circuit Bar Association’s Model Instructions (January 2016) take a different approach to making the same point. Speaking of a “reasonable royalty” generally, without calling out the specific issues of rate and base, the instruction simplifies the *Georgia-Pacific* factors into three foundational considerations:

- (1) The value that the claimed invention contributes to the accused product.
- (2) The value that factors other than the claimed invention contribute to [the accused product].
- (3) Comparable license agreements, such as those covering the use of the claimed invention or similar technology.

FCBA Model Instructions § 6.7 (January 2016). In general, this instruction seeks to focus the jury on the core issues by highlighting just three considerations framed in language that is relatively easy to comprehend and apply (in place of the fifteen *Georgia-Pacific* factors, many of which are opaque). The first two considerations guide the jury to consider the relative value and significance of the claimed invention when determining the royalty arising from the alleged infringement.

As the Supreme Court recognized long ago, it would be “very grave error to instruct a jury ‘that as to the measure of damages the same rule is to govern, whether the patent covers an entire machine or an improvement on a machine.’” *Seymore v. McCormick*, 57 U.S. 480, 491 (1853); see also *Westinghouse Elec. & Mfg. Co. v. Wagner Co.*, 225 U.S. 604, 614–15 (1912) (“[The] invention may have been used in combination with valuable improvements made, or other patents appropriated by the infringer, and each may have jointly, but unequally contributed to the profits. In such case, if plaintiff’s patent only created a part of the profits, he is only entitled to recover that part of the net gains.”); *Garretson v. Clark*, 111 U.S. 120, 121 (1884) (“When a patent is for an improvement, and not for an entirely new machine or contrivance, the patentee must show in what particulars his improvement has added to the usefulness of the machine or contrivance. He must separate its results distinctly

from those of the other parts, so that the benefits derived from it may be distinctly seen and appreciated. . . . ‘The patentee’ . . . must in every case give evidence tending to separate or apportion the defendant’s profits and the patentee’s damages between the patented feature and the unpatented features, and such evidence must be reliable and tangible, and not conjectural or speculative; or he must show, by equally reliable and satisfactory evidence, that the profits and damages are to be calculated on the whole machine, for the reason that the entire value of the whole machine, as a marketable article, is properly and legally attributable to the patented feature.’” (quoting the lower court)). It is incumbent upon the district court to ensure that this important issue is not overlooked.

Another consideration in determining the value of an accused feature is the extent to which that feature could have been replaced with a noninfringing alternative and, if so, the value of that feature over its replacement. The Federal Circuit has recognized the relevance of noninfringing alternatives in the context of reasonable royalty determinations:

Shell also urges that a reasonable royalty may not exceed the cost savings between its proposed non-infringing alternative installation . . . and the patented method. . . . Upon remand, the district court is free to entertain additional evidence by the parties on this fact issue in its re-determination of the damage award. The trial court may also consider any other evidence about non-infringing alternatives.

Riles v. Shell Exploration & Prod. Co., 298 F.3d 1302, 1313 (Fed. Cir. 2002). Yet this critical consideration, too, can be difficult for a jury to appreciate in the context of the long list of *Georgia-Pacific* factors.

The following supplemental instruction ensures against this oversight by explaining the significance of noninfringing alternatives in determining the value of the accused feature:

[Patent holder] claims a reasonable royalty based on [alleged infringer’s] sales of the [accused device/system] rather than sales of the [component] in the [accused device/system]. In these circumstances, a reasonable royalty should reflect the portion of the revenue from sales of the [accused device/system] that result from the improvement provided by the [xxx] patent over alternatives to the patented technology available to the [alleged infringer] at the time that the infringement began.

Where the patentee has claimed both a component and the previously known apparatus or system in which it is used, the instruction should direct the jury to the patented improvement, as explained typically in the patent specification or prosecution history.

This supplemental language should be used to augment the court’s general instructions regarding reasonable royalty. *See, e.g.*, Model Patent Jury Instructions for the Northern District of California, Instruction 5.7 (Reasonable Royalty—Definition) (June 17, 2014) (*see* Appendix E). We note that this specific language regarding noninfringing alternatives has not been formally adopted in any model jury instructions. Nonetheless, it comports with general principles of damages apportionment law and the specific concerns emerging in patent cases involving accused devices incorporating multiple technologies and features.

Consistent with these principles, courts should afford defendants adequate leeway to offer evidence relating to prior judgments or to licenses covering attributes of the accused product not covered by the patent(s) in suit, where the defendants can show that there is a basis for comparing their value to the value of the hypothetical license (e.g., the relative value or importance of the accused and non-accused features covered by the licenses, the relative scope of the licenses, or the like). Thus, if the defendant has licensed other technologies in order to bring the accused product to market, then such licenses may bear on the relative value of the accused product attributable to the patent(s) in suit. Courts should also permit the introduction of evidence relating to the value of different components of an accused device to consumers of the product. This can come in the form of direct testimony of customers, survey evidence, and expert testimony from marketing professionals and economists. Such evidence directly addresses Factor 13 of the *Georgia-Pacific* test and helps to determine whether the patented technology in suit or another component or factor drives demand for the accused product.

7.3.4.7.2 Royalty Rate

The Federal Circuit has recognized that estimating a reasonable royalty is not an “exact science,” and that there may be more than one reliable method. *Apple Inc. v. Motorola, Inc.*, 757 F.3d 1286, 1315 (Fed. Cir. 2014). “For example, a party may use the royalty rate from sufficiently comparable licenses, value the infringed features based upon comparable features in the marketplace, or estimate the value of the benefit provided by the infringed features by comparing the accused product to non-infringing alternatives.” *Id.* Each approach has “strengths and weaknesses,” and each approach may be appropriate and may produce admissible testimony depending on the facts of the case. *Id.*

In *Apple*, the Federal Circuit noted that a “fact finder may award no damages only when the record supports a zero royalty award.” *Id.* at 1327–28 (emphasis added) (noting that “[i]f a patentee’s evidence fails to support its specific royalty estimate, the fact finder is still required to determine what royalty is supported by the record,” whereas, if a patentee fails to meet its burden on lost profits, then no award of lost profits is justified).

The Federal Circuit has in recent years substantially enhanced the court’s gatekeeping role to ensure that a party’s proof of damages is not based on improper “principles and methodology, or legally insufficient facts and data.” *Id.* at 1314. The court rejected the use of general, simplistic apportionment rules. *See id.* at 1324–25; *VirnetX, Inc.*, 767 F.3d at 1331–34 (rejecting the Nash Bargaining Solution); *Uniloc*, 632 F.3d at 1312 (rejecting the “25% Rule”). Thus, *Daubert* motions play a substantial role in screening royalty rate methodologies. *See* § 7.4.3.3.2.1.

7.4 Substantive Limitations on Expert Testimony

Critical to managing a patent trial is the court’s ability to control expert testimony. Of course, expert testimony of various forms is used in a variety of cases, and hence judges are familiar with both the concerns and the safeguards reflected in Fed-

eral Rule of Evidence 702 and the Supreme Court’s decision in *Daubert v. Merrell Dow Pharms.*, 509 U.S. 579 (1993). But patent cases present special challenges for at least three reasons. First, because the factual evidence is often technically complex and difficult to understand, juries may place undue weight on expert testimony, especially when it simplifies (or purports to simplify) the issues that the jury has to decide. Second, many of the legal tests used to evaluate liability and damages incorporate—expressly or implicitly—concepts that largely, if not exclusively, depend upon expert testimony. Thus, experts are aggrandized in patent cases in ways not typical of other types of litigation. Finally, as discussed more fully below, the role that experts play in patent cases does not always fit squarely within the Rule 702/*Daubert* framework. Consequently, managing the scope and content of the experts’ testimony is a critical component of trial management. This section explores issues that courts are likely to confront when evaluating the proper substantive limits of expert testimony in patent cases.

7.4.1 The Role of Experts in Patent Cases

Expert testimony in patent cases may be categorized into at least two distinct types. One, common to most other types of litigation, involves applying an accepted technical or scientific methodology to facts established during the trial to reach conclusions about factual issues. An expert might testify, for example, about the results of her analysis to determine the chemical composition of the accused product. Because this type of testimony is directed to an analysis that the expert regularly performs outside of a litigation context, it falls squarely within the Federal Rule of Evidence 702/*Daubert* framework. Consequently, it presents few distinctive or novel issues and should be familiar to the court.

The second type of testimony presents more challenges. In patent cases, an expert is often asked to use her scientific, technical, or specialized knowledge to evaluate a hypothetical legal construct. For example:

- Who is a “person having ordinary skill in the art”?
- Would a “person having ordinary skill in the art” believe at the time of alleged infringement that differences between the patent claim and the accused product are “insubstantial”?
- At the time the patent application was originally filed, would a “person having ordinary skill in the art” have had a motivation to combine known ideas to create the claimed invention? (Note that, although a patent challenger is not required to show that one of ordinary skill in the art would have had a specific motivation to combine prior art references, such a showing may be helpful to the obviousness analysis. *See KSR*, 550 U.S. at 418; § 14.3.5.2.)
- What royalty rate would the patentee and the infringer have agreed upon had they participated in a negotiation at the time of first infringement knowing that the patent was valid and infringed?

Obviously, it is more difficult for a court to perform its gatekeeping function effectively when this type of testimony is at issue. Because it reflects a hypothetical le-

gal construct, it necessarily departs from the type of generally accepted, peer-reviewed methodology contemplated by Federal Rule of Evidence 702 and *Daubert*. This second type of expert testimony forms the bulk of expert testimony in patent cases. As a result, the majority of issues discussed in this section arise from this type of analysis.

7.4.2 Timing and Procedure: When and How Should the Court Exercise Its Gatekeeping Role?

The first step for the court to take in managing expert testimony in patent cases is to decide when to exercise its gatekeeping role and the process by which to do so. Although many courts permit parties to raise *Daubert* challenges in summary judgment or *in limine* motions, courts are most effective when they establish a separate mechanism for resolving *Daubert* challenges.

One problem with addressing *Daubert* issues as part of summary judgment or *in limine* briefing is that neither provides an adequate means for fleshing out the record on the factual and legal issues relevant to the sufficiency of expert testimony. Summary judgment briefing is inadequate for this purpose because there is little overlap between either the facts or the legal standards for deciding summary judgment and *Daubert* issues. Because both issues are substantial, there typically is not room in a summary judgment brief to do justice to both. The *Daubert* challenge usually gets short shrift: either as a conclusory statement, paragraph, or section tacked on to justify the court overlooking what might otherwise be a question of fact created by expert testimony; or as a series of essentially thematic statements that seek to underscore the purported flaws in the opposing party's position, but nevertheless fail to assist the court because they do not squarely address the legal standard for excluding the expert's opinions.

Dealing with *Daubert* issues at the *in limine* stage presents different challenges, but usually reaches the same result: an insufficient record for thoughtful analysis. *In limine* motions reflect the harried environment in which they are prepared and decided. Briefing is typically sparse and argument short. Although this provides an efficient way to resolve simple evidentiary disputes, it is not an effective way to resolve the more complicated issues presented by a *Daubert* challenge. At a minimum, the court should have thorough, summary-judgment-length briefs from each party, but even this may not be enough in some cases. The court may also need to hear directly from the expert during an evidentiary hearing. This is true whether the motion is styled as a *Daubert* motion or, as is often the case, as a motion *in limine* asking the court to preclude an expert from testifying for a purportedly simple, straightforward reason that, when considered carefully, implicates an issue related to reliability. See, e.g., discussion of conclusory expert opinions in § 7.4.3.3.1.

A more effective way for courts to consider these issues is to include a specific briefing/hearing schedule for *Daubert* motions in its case-management order. See §§ 2.4, 2.6.6. The schedule should be timed such that the motions are filed after experts are deposed on their reports, but well before the pretrial conference. Many courts hear *Daubert* challenges at the same time as, but separate from, summary

judgment motions. Timing the briefing and hearing this way will ensure that a full record is available, but also give the court adequate time to consider the merits of each challenge.

In addition, early consideration of *Daubert* challenges prevents the risk of a party being denied any expert at trial, which in some circumstances can be a harsh sanction for a correctable error. For example, discussed in § 7.4.3.3.2.1.3, a common *Daubert* challenge to a damages expert is based on an alleged incorrect date for the hypothetical negotiation for the determination of a reasonable royalty. Determining that date can be challenging, not only because it depends on technical information related to infringement that is usually beyond the purview of damages experts, but also because the trial court's summary judgment rulings can have a profound effect on that date. So it can happen that while a damages expert's *methodology* can be perfectly adequate, the *factual basis* for the analysis is incorrect as a matter of law. Of course, once informed by the court's summary judgment rulings, the expert can revise her analysis to include the correct information, so if the question is raised through an *in limine* motion on the eve of trial, it may seem unjust to grant the motion and strike the expert. Because of scenarios like this one, and because *Daubert* issues are usually known to the parties through expert reports and depositions well in advance of trial, resolving *Daubert* challenges well before the pretrial conference is good practice.

Expert opinions regarding damages warrant special mention in this context. As discussed in § 2.6.6, district courts frequently wrestle with complex issues related to the reliability and admissibility of damages-related opinions. A variety of factors generate frequent challenges to damages-related theories and evidence, and lead those disputes to be raised with the court at the very end of the case:

- Damages law is evolving rapidly, which generates disputes about the viability of damages theories and expert methodologies.
- Unlike the typical expert opinion on patent liability issues, damages opinions implicate and can draw from economic, mathematical, and financial valuation methodologies that are peer-reviewed and testable, as well as industry experience in patent valuation in the licensing and acquisition context. The interplay between this body of established non-patent-litigation valuation methodologies and the *Georgia-Pacific* factors commonly used to calculate damages in patent cases creates myriad disputes.
- Neither patent local rules nor case-management orders typically require disclosure of damages contentions, as is done with infringement and invalidity.
- Parties tend to focus less extensively on theory development and discovery for damages than they do on liability issues.
- Challenges to damages theories most often come in the form of *Daubert* motions, which are filed after the close of all discovery and, unfortunately, in some instances contemporaneously with motions *in limine*.

As noted, such disputes are almost always raised with the court at the end of the case. As a result, a court that believes that an expert's opinions may not be reliable is typically faced with imperfect options: (1) excluding the expert and leaving the party

with no expert testimony regarding damages at trial; (2) continuing the trial date and providing the party proffering the expert a do-over; or (3) allowing the testimony, despite the court's reservations, with the belief that the jury will see the weakness in the opinions and the intent that, if not, the court will correct the outcome through remittitur, JMOL, or a motion for new trial. In our experience, most courts take the third option (allowing the opinion at trial with the intent to address deficiencies later). Unfortunately, while there are some notable examples of district courts overturning high damages awards based on inadequate expert opinions (*see, e.g., Mirror Worlds LLC v. Apple, Inc.*, 784 F. Supp. 2d 703 (E.D. Tex. 2011)), courts that opt for this approach are too often uncomfortable correcting reliability problems with an expert's trial testimony in view of a jury verdict. In most situations, the second option (excluding the opinions but allowing a new report) is the fairest of these imperfect options. However, courts that follow this path should in most circumstances give the party one chance, and no more, to correct the deficiencies so as to prevent abuse. Allowing multiple do-overs encourages parties to game the system, drains judicial and party resources, and wreaks havoc on the trial schedule.

Of course, the best course is to avoid these problems by resolving the disputes that lead to *Daubert* challenges to damages opinions earlier in the litigation process. Section 2.6.6 discusses some case-management tools that may be used to identify and resolve challenges to damages theories and evidence earlier in the case.

7.4.3 Specific Substantive Limitations on Expert Testimony

This section explores substantive limitations on expert testimony that either arise from the unique attributes of a patent case or have a significant or unusual impact on patent cases. Motions invoking these limitations typically fall into one of three broad categories: (1) they allege that the expert opinions are directed to improper subject matter; (2) they allege that the expert is unqualified to render the opinion in question; or (3) they allege that the expert's analysis is insufficiently reliable to be admissible under Federal Rule of Evidence 702.

7.4.3.1 Improper Subject Matter

Motions to preclude expert testimony directed at "improper" subject matter, which commonly arise when experts offer opinions about the research and development (R&D) leading to the patent or the prosecution of the application, usually make one of two allegations: (1) that the expert improperly speculates about what another person was thinking at a given time; or (2) that the expert is giving an opinion on a matter of law, which usurps the role of the judge. Each of these bases presents distinct issues for the court to consider.

7.4.3.1.1 State of Mind of Another Person, Usually an Inventor, Prosecutor, or Examiner

An objection that an expert improperly speculates about what another person thought, believed, or knew most frequently arises when an expert gives an opinion

about why the inventor took a particular course of action during the R&D that led to the patent-in-suit. Perhaps the most common example is where an expert offers opinions that an inventor was motivated by a particular goal or found some aspect of the research particularly challenging. A less common, but real-world example is that an expert might review documents describing the inventor's field of study and then offer an opinion that the inventor would have known that a particular laboratory had expertise in that field. This issue also arises in expert testimony about patent prosecution. For example, an expert might offer opinions about why a prosecutor elected not to submit a reference or why an examiner cited or did not cite a piece of prior art when that information is not stated explicitly in the prosecution history.

The moving party generally argues that the expert is simply speculating about the state of mind of the inventor, prosecutor, or examiner. As a result, the opinion is not based on scientific, technical, or specialized knowledge and is not the proper basis for an opinion. Indeed, it is an argument that a lawyer, not an expert, should make. If asserted as fact, it should be presented through a witness with personal knowledge, such as the prosecutor or inventor himself. In response, the party offering the testimony typically argues that the expert does not seek to offer an opinion as to what the inventor, examiner, or prosecutor actually thought. Instead, the expert is opining, based on her expertise in the relevant field, what was typical or standard practice for someone in that situation to do.

The court should evaluate this type of motion on a case-by-case basis. Whether the testimony is appropriate will depend in part upon whether the expert stops short of testifying about what the inventor, examiner, or prosecutor actually believed. If so, the court should also evaluate whether knowledge about the standard practice among similarly situated people will help the jury answer the question at hand or inappropriately distract the jury and affect the result for an inappropriate reason.

7.4.3.1.2 Matters of Law

This type of objection to expert testimony arises when the expert intends to testify about what legal requirements apply to a particular person or situation. Most commonly, this occurs when an expert testifies about the prosecution of the patent in suit. For example, the expert might seek to inform the jury that the law requires a prosecutor to disclose all material prior art of which she is aware. The expert may wish to testify about the standard for materiality. Although most common in connection with testimony about patent prosecution, this issue may arise in other contexts as well. For example, an expert might attempt to offer testimony that a class of conduct is legally actionable by stating that offering a warranty on a product sold before the patent issued can constitute active inducement of infringement.

The moving party typically argues that an opinion about the state of the law inappropriately usurps the role of the judge, whose duty it is to instruct the jury about the law. Because the moving party is correct that an expert generally may not testify about the state of the law, *see, e.g., Hygh v. Jacobs*, 961 F.2d 359, 363–64 (2d Cir. 1992); *United States v. Wilson*, 133 F.3d 251, 265 (4th Cir. 1997); *Aguilar v. Int'l Longshoremen's Union Local 10*, 966 F.2d 443, 447 (9th Cir. 1992); *United States v. Brodie*, 858 F.2d 492, 496 (9th Cir. 1988), the party offering the testimony typically

argues that the expert is offering testimony about a permissible subject, such as Patent Office practice and procedure. *See, e.g., Buckley v. Airshield Corp.*, 116 F. Supp. 2d 658, 662 (D. Md. 2000). If the court determines that the proffered opinion purports to set forth the governing law, it should exclude the testimony.

7.4.3.2 Inadequate Qualifications

Challenges to an expert's credentials typically present the same issues in a patent case that they do in any other case. As a result, most issues related to these motions do not merit special treatment in patent litigation. But one patent-specific issue does arise with some frequency: whether a technical expert must have experience in the specific technology that is accused of infringement. For example, in a case in which a certain type of car door is the subject of the infringement claim, the expert may have a Ph.D. in mechanical engineering and computational and applied mathematics, but no experience in the automotive industry and no experience designing car doors. Should the expert be precluded from testifying on aspects of automotive door design?

The movant will typically argue that although the expert may have education, training, and experience that qualifies her as an expert in other fields, her lack of experience with the accused technology prevents her from having the specialized knowledge necessary to offer reliable opinions about the accused products. The party offering the expert will usually argue that experience with the accused technology is not a *per se* requirement, and that the witness's education and training—although not specific to the accused product—provide the requisite foundation for the opinion. This issue, the argument goes, should be directed to the weight that the jury gives to the testimony, not its admissibility.

Although experience with the technology at issue is not a *per se* requirement, it may be necessary to provide a foundation for the opinions being proffered in some cases. *Compare Tormenia v. First Investors Realty Co., Inc.*, 251 F.3d 128, 136 (3d Cir. 2000), with *United States v. Marler*, 614 F.2d 47, 50 (5th Cir. 1980). Consequently, the specific opinions that the expert intends to offer should determine the outcome. For example, the expert with a Ph.D. in mechanical engineering mentioned above may be sufficiently qualified to compare the mechanical aspects of the accused door with the patent claims, but may not have the requisite knowledge to testify about manufacturing standards applicable in the automotive industry. Thus, the court will need to resolve this issue on a case-by-case basis, above all by applying its common sense to determine whether the expert has sufficient foundation to offer the opinions in question.

7.4.3.3 Unreliable Analysis

The third category of disputes about the substantive admissibility of expert opinions centers on whether the analysis leading to the opinions was reliable. Generally, the party challenging the expert's opinion makes one of two assertions: (1) that the expert's opinion is conclusory or (2) that the expert misapplied an accepted method-

ology. The first type of motion most often arises with technical experts; the latter with damages experts, survey experts, and those testing or analyzing accused products.

7.4.3.3.1 Conclusory Expert Opinions

Disputes about conclusory expert opinions often take the form of motions *in limine* that seek to preclude a technical expert from offering an opinion about a general issue because the expert provided only a conclusory opinion about that issue in the expert's report. Motions of this nature are most commonly filed to exclude opinions about obviousness and infringement under the doctrine of equivalents. The "conclusory" opinions sought to be excluded typically take one of two forms. One is a bald statement at the beginning or end of the expert's report offering the expert's conclusion about the ultimate issue, such as the following, after a discussion of literal infringement:

Moreover, to the extent that there are any differences between the accused product and Claim 1, they are insubstantial and the accused products infringe under the doctrine of equivalents.

The other is an opinion that, although addressing a specific claim element and product, does no more than parrot an accepted test for determining the ultimate issue, such as the following:

Although Claim 1 requires "a layer" that performs both functions, the combination of two layers in the accused product achieves substantially the same functions in substantially the same way to achieve substantially the same result as would a single layer.

In both cases, the opinion sought to be excluded is usually preceded or followed by a discussion of the general technology of the patent-in-suit, a discussion of the accused product (or asserted prior art reference), and a detailed discussion of literal infringement (or of anticipation), but there is no other mention of equivalents (or obviousness).

The moving party typically argues that the only discussion in the expert report related to equivalents (or obviousness) is a single conclusory opinion such as the ones set forth above. As a result, it is impossible to determine the basis for or test the reliability of the expert's conclusions. Citing a wealth of case law, the party argues that the conclusory opinion is insufficient. *See, e.g., Dynacore Holdings Corp. v. U.S. Philips Corp.*, 363 F.3d 1263, 1278 (Fed. Cir. 2004). Because conclusory opinions devoid of analysis are indeed inadmissible, the party offering the testimony usually counters that the statement is merely a summary of the conclusion, which is based on the detailed discussions found elsewhere in the report.

To evaluate this dispute in the context of the doctrine of equivalents, the court should keep in mind the differences between an analysis of literal infringement (where the test is whether the claim limitation matches the accused instrumentality exactly) and of infringement under the doctrine of equivalents (where the test is whether the differences between the claim limitation and the accused instrumentali-

ty are insubstantial—typically measured by whether one skilled in the art would consider them to be interchangeable, or whether they perform substantially the same function, substantially the same way, to achieve substantially the same result). Because the tests are different, an expert opinion discussing why the claim limitation matches exactly the accused instrumentality often does not, but may in some cases, provide foundation for a conclusion that any differences are (or are not) insubstantial.

To evaluate this dispute in the obviousness context, the court should likewise keep in mind the differences between an analysis of anticipation (where the test is whether a single prior art reference discloses all the limitations of a claim exactly) and obviousness (where the test is whether a single reference fails to disclose every element, but nevertheless, by itself or in combination with other references, renders the specific claimed combination of limitations obvious to one of ordinary skill in the art at the time of invention, in view of the *Graham* factors and *KSR*). See § 14.3.5.

Opinions discussing literal infringement typically do not contain the additional material necessary to support a doctrine of equivalents opinion, because that additional subject matter is not, in most cases, germane to whether or not the literal infringement test is satisfied. An expert who elects not to include that material in a separate doctrine of equivalents opinion typically also elects not to include it in the literal infringement opinions. Likewise, the differing standards means that an opinion seeking to establish anticipation by showing the disclosure of each claim element in a prior art reference does not need to include the types of information pertinent to evaluating obviousness. Experts who do not address the underlying factors in detail in their obviousness opinions also typically do not address that subject matter in their anticipation opinions. Practices vary widely, however, from expert to expert and, even with the same expert, from case to case, so the court must assess for each dispute whether the specific opinions in question provide the requisite foundation for the proffered conclusion.

As this discussion illustrates, this type of motion generally requires more than a cursory review of the expert's report and provides a good example of why *in limine* motion practice is not a good vehicle for deciding *Daubert* issues. Although seldom styled as a *Daubert* motion, this dispute implicates the court's gatekeeping role under Federal Rule of Evidence 702. Indeed, the court must determine whether the other sections of the report reflect the reliable implementation of a reliable methodology that provides a foundation for the challenged opinion. Instead of a thorough analysis of these sections under Rule 702 and *Daubert*, the court is almost always presented with a bare excerpt from the report, a few stern quotations from the Federal Circuit, and no time to dig deeper before deciding the motion. An effective strategy for addressing this issue is for the court to set a separate briefing schedule for *Daubert* motions. In any event, the outcome should be determined on a case-by-case basis and will depend on whether the other sections of the report do, indeed, support the opinion alleged to be conclusory.

7.4.3.3.2 Unreliability of the Methodology or Its Application

Although disputes of this nature could arise with respect to any expert, they most commonly arise in patent cases in connection with the computation of damages. *See generally* § 14.4.3.2. Consequently, all of the examples discussed here relate to methods for calculating damages. The law requires that a patentee be awarded damages “adequate to compensate for infringement, but in no event less than a reasonable royalty for the use made of the invention by the infringer.” § 284. In practice, this means damages based on a “reasonable royalty” will be an issue in almost every patent case because a “reasonable royalty” is the “floor below which damage awards may not fall.” *Rite-Hite Corp. v. Kelley Co.*, 56 F.3d 1358, 1544 (Fed. Cir. 1995) (en banc). Expert testimony supporting a reasonable royalty analysis raises two clusters of issues. The first cluster concerns the methodology used to calculate the royalty; the second concerns the scope of the base to which the royalty rate is applied. In addition, a growing number of cases use surveys to establish the value of an accused feature and to show the volume of use for purposes of establishing direct infringement by third parties that underlies a claim of indirect infringement or proving damages, among other reasons. Because the surveys are litigation-driven and often involve modifications to peer-reviewed methodologies or limited or allegedly non-representative sample sizes, experts proffering opinions based on such surveys are commonly the subject of *Daubert* challenges. For general background on survey methodology, see Shari Seidman Diamond, *Reference Guide on Survey Research*, in *Reference Manual on Scientific Evidence* 361 (Federal Judicial Center and National Research Council of the National Academies, 3d ed. 2011).

7.4.3.3.2.1 Misapplication of the *Georgia-Pacific* Factors

Courts have generally accepted the multifactor analysis set forth in *Georgia-Pacific*, 318 F. Supp. at 1120, as the framework for calculating a reasonable royalty. *See, e.g., Fromson v. W. Litho Plate & Supply Co.*, 853 F.2d 1568 (Fed. Cir. 1988), *overruled on other grounds by Knorr-Bremse Systeme Fuer Nutzfahrzeuge GmbH v. Dana Corp.*, 383 F.3d 1337, 1343 (Fed. Cir. 2004). Under this framework, the proffered expert attempts to determine what the royalty would have been had the parties conducted a negotiation at the time of first infringement, with both parties willing to enter into a license, having knowledge that the patent was valid and infringed. (The negotiation is, of course, hypothetical and counterfactual, as the existence of the suit shows.) *Georgia-Pacific (GP)* lays out fifteen factors to be considered as part of this hypothetical negotiation. Because the framework is so widely used, most *Daubert* challenges to expert opinions on damages stem from a purported misapplication of the *GP* factors.

Indeed, damages issues are heavily fact-dependent and are far from one-size-fits-all. It takes significant effort on the part of each party and experts to find and use the proper data, analyses, and damages framework that fits the available facts and that properly falls within the bounds of the legal requirements. *See, e.g., Apple Inc. v. Motorola, Inc.*, 757 F.3d 1286, 1315–26 (Fed. Cir. 2014) (except for one minor exception, reversing the district court’s exclusion of proposed damages testimony, noting

that “estimating a ‘reasonable royalty’ is not an exact science,” that there may be more than one reliable method, and that “one approach may better account for one aspect of a royalty estimation does not make other approaches inadmissible”); *ResQNet.com, Inc. v. Lansa, Inc.*, 594 F.3d 860, 870–72 (Fed. Cir. 2010) (vacating a damages award where expert had relied on re-bundling licenses that had no relationship to the claimed invention and finding that in this instance the most reliable licenses arose out of litigation, whereas in most other occasions, the court had found that litigation itself could skew the results of the hypothetical negotiation).

7.4.3.3.2.1.1 Consideration of Factors Not Specified in *Georgia-Pacific*

Although application of the fifteen *GP* factors is nearly universal, some experts rely on other factors in some cases. For example, an expert with years of licensing experience in a particular industry may elect to consider additional factors used in that industry when calculating a reasonable royalty for patents in that industry. As another example, if the patent-in-suit was purchased from the patentee by the plaintiff, an expert might consider the value attributed to that patent during the acquisition. Alternatively, an expert might offer an opinion that takes into consideration the cost to design around the patent, the cost of removing the infringing feature from the accused product, the value attributed to the technology by respondents to marketing surveys, or myriad other factors.

When an expert does this, the opposing party often seeks to exclude the opinion on the basis that the expert departed from the accepted methodology by considering additional factors. The party offering the testimony usually counters that the specific factors outlined in *GP* are an accepted, *but not required*, tool for evaluating the outcome of a hypothetical negotiation. Indeed, the *GP* factors are not exclusive. *Georgia-Pacific*, 317 F. Supp. at 1120. If the expert can provide information that shows that the additional factor considered is generally accepted as relevant to valuation and was reliably applied in this instance, the court should allow the opinion. *See, e.g., Apple*, 757 F.3d at 1315 (“a party may . . . estimate the value of the benefit provided by the infringed features by . . . comparing the accused product to non-infringing alternatives”) (citations omitted); *Open Text S.A. v. Box, Inc.*, 2015 U.S. Dist. LEXIS 8783, 2015 WL 393858, *3–4 (N.D. Cal. Jan. 29, 2015) (citing and distinguishing *Mars, Inc. v. Coin Acceptors, Inc.*, 527 F.3d 1359, 1373 (Fed. Cir. 2008)) (allowing expert opinion regarding noninfringing alternative and noting that “*Mars* is not a blanket prohibition on expert testimony about non-infringing alternatives as a damages measure. As the Federal Circuit has held [in *Apple*] . . . basing a reasonable royalty estimate on the cost of implementing non-infringing alternatives is an allowable methodology That *Mars* only forbids ‘courts, not experts, imposing caps based on expected profits as a matter of law’ is a reading endorsed by other district courts.”).

7.4.3.3.2.1.2 Selective Use of the *Georgia-Pacific* Factors

Similarly, experts often combine several of the *GP* factors or decline to apply one or more factors in a given case. The issue is essentially the same—*GP* provides the core framework and factors that may be used in evaluating a royalty within that framework, but there is no express requirement that every factor be applied in every case. In considering a motion brought on this ground, the court should evaluate the totality of the analysis to determine whether it reflects the overall framework, rather than evaluate the expert’s consideration (or lack of consideration) of each factor in isolation.

7.4.3.3.2.1.3 Use of an Incorrect Date for the Hypothetical Negotiation

Another commonly brought motion seeks to exclude an expert opinion on the grounds that the expert used the wrong date for the hypothetical negotiation. This most often arises where multiple patents are asserted. For example, a common approach when multiple patents are at issue is to assume that the royalty for all patents is determined during a single negotiation that occurred at the time of first infringement of the earliest-infringed patent. This is especially true when the patents are part of the same patent family.

The movant usually argues either that the expert’s use of an incorrect date conflicts with the legal standard or that it renders the analysis unreliable. Of course, the party offering the testimony disagrees, arguing that it is the jury’s province to determine which of the factual scenarios that undergird the expert’s analysis is more accurate. Thus, the issue goes to weight, not admissibility. The non-movant usually has the better argument. If the expert can identify a plausible explanation for the date selected that is consistent with the flexible hypothetical construct (e.g., the opinion covers a multiple-patent scenario, or reflects one party’s contention about when infringement began), then the motion should be denied. See *Brunswick Corp. v. United States*, 46 U.S.P.Q.2d 1446 (Fed. Cir. 1998) (unpublished). In the case where the date used bears no logical relationship to the date of first infringement, however, the court should grant the motion. See *Unisplay, S.A. v. Am. Elec. Sign Co., Inc.*, 69 F.3d 512, 518 (Fed. Cir. 1995); *Hanson v. Alpine Valley Ski Area, Inc.*, 718 F.2d 1075, 1079 (Fed. Cir. 1983) (“the key element in setting a reasonable royalty . . . is the necessity for return to the date when infringement began”).

7.4.3.3.2.1.4 Use of Facts that Post-Date the Hypothetical Negotiation

A fourth frequently filed motion concerns the extent to which experts can rely on events that occurred after the date of first infringement in their analysis of the *GP* factors. The movant typically contends that the analysis is legally deficient or unreliable because it relies exclusively or partially on such facts. In response, the party offering the testimony typically argues that considering the post-infringement facts is helpful and sometimes necessary to ensure that the result of the hypothetical negotiation does not stray too far from actual events. Here, both parties can have legitimate

points and the resolution depends on a subtle distinction: the expert must base her opinion on facts that predate the hypothetical negotiation, but may look to post-negotiation facts as a reality check.

In *Fromson v. Western Litho Plate & Supply Co.*, the Federal Circuit discussed the role that facts occurring after the date of the hypothetical negotiation can play in the analysis:

The methodology encompasses fantasy and flexibility; fantasy because it requires a court to imagine what warring parties would have agreed to as willing negotiators; flexibility because it speaks of negotiations as of the time infringement began, yet permits and often requires a court to look to events and facts that occurred thereafter and that could not have been known to or predicted by the hypothesized negotiators.

853 F.2d 1568, 1575 (1988), *overruled on other grounds by Knorr-Bremse Systeme Fuer Nutzfahrzeuge GmbH v. Dana Corp.*, 383 F.3d 1337, 1343 (Fed. Cir. 2004). This language in *Fromson* flows from the Supreme Court's discussion of post-infringement facts in *Sinclair Ref. Co. v. Jenkins Petroleum Co.*:

But a different situation is presented if years have gone by before the evidence is offered. Experience is then available to correct uncertain prophecy. Here is a book of wisdom that courts may not neglect. We find no rule of law that sets a clasp upon its pages, and forbids us to look within. . . . To correct uncertain prophecies in such circumstances is not to charge the offender with elements of value non-existent at the time of his offense. It is to bring out and expose to light the elements of value that were there from the beginning.

289 U.S. 689, 697 (1933). Nevertheless, an expert is not free to disregard entirely the date of first infringement and base her opinion entirely upon post-infringement facts:

Burns was not discussing what royalty rate a hypothetical negotiation would have yielded *at the time infringement began*. Instead, Burns was testifying to what the parties might arrive *at the time of trial*. Such testimony was not directed to the proper reasonable royalty criteria and therefore cannot support the jury's verdict.

Unisplay, S.A. v. Am. Elec. Sign Co., Inc., 69 F.3d 512, 518 (Fed. Cir. 1995). *See also Hanson*, 718 F.2d at 1081 ("The issue of the infringer's profit is to be determined not on the basis of a hindsight evaluation of what actually happened, but on the basis of what parties to the hypothetical license negotiations would have considered at the time of the negotiations.").

From this medley of pronouncements about the relevance of post-negotiation facts, the conclusion emerges that an expert who uses the hypothetical negotiation framework must ground his or her opinion in facts that would have been known on the date of the hypothetical negotiation, but may also consider post-negotiation facts to color his or her analysis such that it does not depart dramatically from actual events. Thus, if the court finds that the analysis is based primarily or exclusively upon post-negotiation facts, the opinion should be excluded. On the other hand, the opinion should be admitted if the court finds that the expert merely uses post-negotiation facts to supplement his or her analysis of prenegotiation facts.

7.4.3.3.2.2 Use of an Incorrect Base for Damages

Another damages-related dispute that merits discussion concerns the appropriate base from which damages are to be measured. Most commonly, this dispute arises in one of two situations: (1) where the patentee accuses a component of a larger system or product of infringement but seeks a royalty base that includes the entire system or product; or (2) where the patentee seeks to include products sold in connection with the infringing product (allegedly “convoyed sales”) in the royalty base. Typically, this dispute takes the form of a motion *in limine* to preclude the patentee from presenting evidence or argument concerning damages based on the entire system or on “convoyed sales.”

Some such disputes are not directed at the reliability or helpfulness of expert testimony per se, but rather focus on whether the patentee has a legal basis for seeking damages that extend beyond the infringing component or product. Such disputes are best presented through summary judgment (in cases where the theory has been developed through discovery) or motions *in limine* (in cases where the accused infringer seeks to prevent argument or testimony that has been hinted at, but not developed, through discovery). In other cases, parties seek to challenge the methodology by which an expert apportions the value of an accused feature in a multifeature product and, therefore, raise such issues in a *Daubert* motion.

In its *Lucent* decision, the Federal Circuit held that in the reasonable royalty context, the base can be the entire product so long as the rate accounts for the relative contribution of that feature in comparison with other features. *See* § 7.3.4.7. The Federal Circuit subsequently explained that “consideration of the entire market value of accused products for minor patent improvements simply by asserting a low enough royalty rate” is impermissible. *Uniloc USA, Inc. v. Microsoft Corp.*, 632 F.3d 1292, 1320 (Fed. Cir. 2011). The majority of disputes of this nature in the reasonable royalty context are likely to focus on the methodology or reliability of the analysis and thus to be brought in a *Daubert* motion.

7.4.3.3.2.3 Reliance on a Legally Insufficient Methodology

The principal area in which this is likely to arise in patent cases is with respect to the improper use of “rule of thumb” methodologies, such as use of the so-called “25% Rule” or an inappropriate application of the Nash Bargaining Solution used by some experts in calculating reasonable-royalty damages.

The essence of the “25% Rule” is that a patentee should recover 25% of the profits garnered by the accused infringer from its sale of an accused product. In *Uniloc*, the Federal Circuit held as a matter of law that the “25% Rule” is an unreliable methodology by which to calculate a reasonable royalty:

This court now holds as a matter of Federal Circuit law that the 25 percent rule of thumb is a fundamentally flawed tool for determining a baseline royalty rate in a hypothetical negotiation. Evidence relying on the 25 percent rule of thumb is thus inadmissible under *Daubert* and the Federal Rules of Evidence, because it fails to tie a reasonable royalty base to the facts of the case at issue.

632 F.3d at 1315.

The Nash Bargaining Solution suggests that where two persons bargain over a matter, there is a “solution” to the negotiation problem in which each bargainer gets the same money profit, such that they will split 50/50 the incremental profits that are associated with the use of the patented technology. The Federal Circuit rejected this methodology unless the party “sufficiently establish[es] that the premises of the theorem actually apply to the facts of the case at hand,” because such use would be an “inappropriate ‘rule of thumb.’” *VirnetX*, 767 F.3d at 1332–34 (“The Nash theorem arrives at a result that follows from a certain set of premises. It itself asserts nothing about what situations in the real world fit those premises. Anyone seeking to invoke the theorem as applicable to a particular situation must establish that fit, because the 50/50 profit-split result is proven by the theorem only on those premises.”).

In the wake of these cases, two types of disputes are likely to arise. First, a party might assert that an expert is surreptitiously relying on the 25% Rule in his or her analysis. Second, and more commonly, a party might assert that the expert is relying on some other “rule of thumb” (e.g., IBM’s historical 1%-per-patent rate) or is applying a methodology in a manner that fails to take the specific facts of the case into account. The misapplication of the Nash Bargaining Solution is the prime, but not only, example—similar criticisms could arise with respect to any methodology if the expert does not tie the methodology or model to the specific facts of the case.

In both types of disputes, the court should evaluate the methodology underlying the expert’s opinions, as well as the manner in which the expert applies that methodology. It should consider the Federal Circuit’s explicit basis for excluding the expert opinions in *Uniloc* and *VirnetX*: that the “rule of thumb” failed to weigh the specific facts of a given case to reach the royalty that would be reasonable in light of that specific fact pattern. Applying this reasoning, other methodologies—or applications of methodologies—that fail to draw their conclusions from the specific facts of the case at hand should be excluded.

7.4.3.3.2.4 Litigation Surveys

In recent years, it has been more common for a party—typically the patentee—to proffer expert testimony based on a survey conducted specifically for the litigation to support its damages calculation or other contentions. For example, a survey might show the alleged value of the accused feature or the alleged invention, estimate the percentage or overall volume of use of the accused feature or product, or estimate the extent to which a feature drives sales of the product into which it is incorporated. See, e.g., *Lucent*, 580 F.3d at 1333–34. The opposing party often objects to the reliability of the survey on the grounds that it does not comply with generally accepted and peer-reviewed methodologies for conducting surveys. For example, the party opposing the survey may argue that the questions were not properly formulated or balanced, that the process by which responses were tabulated were subjective or were otherwise unreliable, that the sample was not representative, that the sample size was too small, and the like. See, e.g., *Lucent Techs., Inc. v. Microsoft Corp.*, 837 F. Supp. 2d 1107, 1122–24 (S.D. Cal. 2011).

Unlike much of the expert testimony offered in patent cases, survey-based opinions arise from a field with well-documented and peer-reviewed methodologies on

which a court can and should rely to evaluate the reliability of the particular survey in question. See generally Shari Seidman Diamond, *Reference Guide on Survey Research*, in *Reference Manual on Scientific Evidence* 361 (Federal Judicial Center and National Research Council of the National Academies, 3d ed. 2011). Moreover, provided that the survey accords with accepted, peer-reviewed methodologies, criticisms of the particular methodology used, the survey design, its reliability, and the conclusions drawn typically go to the weight, not the admissibility, of the survey results. See, e.g., *Microsoft Corp. v. Motorola, Inc.*, 904 F. Supp. 2d 1109, 1120 (W.D. Wash. 2012) (applying Ninth Circuit standards for admissibility of survey material). This principle, however, has limits. Irrational results, especially when presented without a reasonable explanation of the criteria used to design the survey, may in some circumstances be sufficient for exclusion. See, e.g., *Oracle Am., Inc. v. Google, Inc.*, 2012 U.S. Dist. LEXIS 33619, 2012 WL 850705, at *11 (N.D. Cal. Mar. 13, 2012) (excluding conjoint analysis where the expert included three patented features among the seven studied features, failed to include important non-patented features among the seven tested features, and failed to provide any reasonable criteria for the selection). Moreover, simply confirming that the expert reliably applied an accepted, peer-reviewed methodology is not sufficient to determine admissibility—the other requirements for admissibility of expert testimony must also be met. This is especially important to keep in mind, because expert opinions relating to surveys are typically layered—for example, one might have an underlying survey showing how respondents ranked certain tested features (first layer), an opinion interpreting those results and offering a conclusion about the extent to which the tested features drive customer demand (second layer), and an opinion relying on the conclusions about the extent to which the *tested features* drive customer demand to draw conclusions about the extent to which the *patented features* are the basis for consumer demand for the allegedly infringing product (third layer). Even if the first- and second-layer opinions are reliable, the third-layer opinion may not be. For example, valid survey results and valid conclusions about features tested in the survey may not support conclusions about the use, value, or effect on customer demand of the *patented* feature if the features *tested* do not match the features *patented*. As one district court observed:

At some point, a description of a patent in a survey may vary so much from what is claimed that the survey no longer “relate[s] to any issue in the case” and is “not relevant and, ergo, non-helpful.” *Daubert*, 509 U.S. at 591. Such survey evidence would not “help the trier of fact” and therefore must be excluded under Rule 702(a). Moreover, at some point, discrepancies between the scope of the patent claims and the survey questions may be so confusing to the jury as to substantially outweigh the survey’s probative value, thus requiring the Court to exclude such material under Rule 403.

Apple Inc. v. Samsung Elecs., Co., 2014 U.S. Dist. LEXIS 24506, 2014 WL 794328 (N.D. Cal. Feb. 25, 2014) (holding, based on the particular facts of the case, that the disparity between the scope of the claims and the scope of the survey questions did not warrant exclusion of the conclusions the expert drew from the survey results).

Thus, a court considering a *Daubert* challenge to “survey opinions” should consider carefully not just the methodology used to conduct the survey, but also whether

the conclusions drawn by the survey expert (and experts relying on the opinion of the survey expert) about the data are both consistent with the issues that the survey was designed to measure and genuinely helpful to evaluate the ultimate factual or legal issue in support of which it is proffered. To assist them with this fact-intensive and context-specific exercise, courts should require the party challenging the “survey opinion” to identify what precisely is being challenged (i.e., in the example above, the survey data (first layer), the intermediate conclusions about the tested features (second layer), or the ultimate conclusions about the patented invention (third layer)) and require the party proffering the testimony to identify how precisely the challenged material is proposed to be used.

7.4.4 Motions Seeking to Prevent Lay Witness Opinions and Expert Witness Fact Testimony

Because of the multifaceted role that expert witnesses play in patent cases, it can be difficult to draw the appropriate distinction between a technical expert witness and a technically skilled fact witness, such as an inventor. In addition to her opinions, an expert witness may have personal knowledge of facts relevant to disputed issues. Further complicating trial management, fact witnesses may be just as credentialed as expert witnesses and all too willing to offer their opinions about a multitude of subjects.

To manage this situation, the court should employ a simple guiding principle: the relationship between fact testimony and expert testimony does not change simply because a fact witness has a technical background or the expert witness has personal knowledge of relevant facts. To the extent that the witness has personal knowledge of relevant facts, she may testify about them whether or not they are technical in nature, so long as the fact-witness disclosure requirements are met. She may also testify as to lay witness opinions, but may not offer opinions of an expert nature unless she is disclosed as an expert witness. If a witness is to offer expert opinions at trial, she must satisfy both the disclosure requirements (Fed. R. Civ. P. 26(a)(2)(B) for retained experts, and 26(a)(2)(C) for other witnesses offering expert opinions, including most employee witnesses) and the reliability standards for expert testimony.

7.5 Managing Patent Trials Through Motions *In Limine*

As discussed throughout this guide, active management of patent cases is crucial at every stage of the litigation. But nowhere is such management more important than during a jury trial—just ask a befuddled juror required to apply an infringement analysis to a multiplicity of claims and accused products amid a bewildering set of technical facts. Motions *in limine* provide the court with an opportunity to establish procedures and substantive limitations that will streamline the evidence, shorten the trial, and reduce jury confusion.

Courts should consider a number of questions with respect to each motion:

- Is this a motion that needs to be decided now, or should it wait for additional context and information to be elicited at trial?
- What is the relationship between the substantive issue for which the party seeks to exclude evidence and other substantive issues in the case?
- Is the evidence sought to be excluded potentially relevant to multiple issues?
- Is the motion effectively dispositive?
- Should the motion have been brought at the summary judgment stage?

The court should bear in mind that although substantive to some degree, these motions largely implicate procedural requirements and the balancing test of Federal Rule of Evidence 403. For this reason, some courts choose to hear motions *in limine* at the outset of a trial so that they are better acquainted with the disputes that are likely to arise, and then continue some portion of them until the issues are fleshed out during the course of the proceeding. If the court takes this path, it should admonish counsel to ask for a sidebar before introducing evidence that was the subject of a continued motion. In addition, courts should be wary of simply deferring *all* evidentiary decisions because resolving them during trial can extend and interrupt the proceedings and place additional burdens on the jury.

7.5.1 Maintaining the Integrity of the Infringement/ Validity Framework

Patent cases incorporate a number of legal standards that can be difficult for an advocate to explain and even more difficult for a jury to apply. For example, as discussed in § 14.4.1.4, to determine whether an accused product infringes a particular claim, one must compare each limitation of that claim with the accused product to assess whether the limitation is satisfied, either literally or under the doctrine of equivalents. *See, e.g., Aquatex Indus., Inc. v. Techniche Sols.*, 419 F.3d 1374, 1382 (Fed. Cir. 2005). This analysis must be applied to each accused product and for each claim. In the context of a complex technology, this exercise is virtually guaranteed to confuse at least some members of a jury. No wonder, then, that parties make significant efforts to identify shortcuts to proving infringement and validity.

The first constellation of frequently filed, patent-specific motions arises as a response to these efforts. Typically styled, in whole or in part, as seeking to focus the evidence on the required legal standard, these motions ultimately seek to close shortcuts to proving infringement and invalidity. Because these issues arise in nearly every patent case, a substantial portion of pretrial filings, including motions *in limine*, is often pitched to the court as attempts to require the opposing party to adhere to the proper legal standard. But, of course, not all motions pitched that way actually aim to maintain the integrity of the legal standards. Indeed, they often seek to preclude legitimate evidence relevant to a different issue by contending that it improperly alters the infringement or validity analysis. This section highlights four commonly brought motions implicating these issues.

7.5.1.1 Motion to Bar a Comparison Between the Accused Product and an Embodying Product (or Between Prior Art and an Embodying Product)

This motion is typically brought by the accused infringer to prevent the patentee from comparing the accused product to the patentee's product, but not exclusively so. The movant generally argues that the comparison should be barred under Federal Rule of Evidence 403 because the comparison has no probative value as to infringement, and there is a substantial risk of jury confusion resulting in an improper infringement analysis.

From a substantive standpoint, a party clearly cannot be permitted to argue that a comparison between commercial products shows that the patent is or is not infringed. Of course, no sophisticated litigant would openly offer the comparison for this purpose. Instead, the respondent typically argues that the comparison has probative value for an issue other than infringement. For example, a patentee may argue that the comparison is probative of whether the infringement was willful because it shows that the accused infringer copied the patentee's product. Alternatively, after putting on evidence concerning differences between the accused products and claim limitations, an accused infringer might argue that the comparison will help the jury understand the evidence that has already been presented.

In either case, the risk of confusion is high because it is easier in most cases to compare two products than to compare the product with the often-confusing language of a patent claim. For this reason, allowing comparisons with an embodying product creates an especially high risk of confusion. Thus, at a minimum, the party that wishes to make such a comparison must be instructed that it cannot argue or attempt to imply that the comparison itself bears on infringement. Note that one or both of the parties may appropriately refer to embodying products in other contexts that do not implicate the concerns and potential confusion outlined above. For example, a patentee may refer to a commercial embodiment to argue that the alleged invention was commercially successful, thus rebutting an argument that the alleged invention was obvious. Likewise, an accused infringer may refer to a commercial embodiment to argue that the asserted claims are invalid, because a product or process embodying them was offered for sale in the United States more than a year before the application for the patent was filed.

Because of the risks of confusion, the court should consider deferring its ruling on a motion to exclude a comparison between the accused product and an embodying product until it can fully appreciate the context in which the jury will see the comparison. If the court elects to defer this or any other motion *in limine*, it should impose strict conditions on how the motion will be addressed during trial. For example, it should bar the parties from using the comparison in opening statements, and it should instruct the parties that the dispute over this evidence absolutely will not be addressed in the presence of the jury. Instead, the party offering the evidence should be required to notify the court on the day preceding the trial day when it will offer the evidence. The court should hear the motion before trial begins for that day. If the offering party or the court believes that testimony yet to be elicited will provide relevant context, the court should require the offering party to provide an offer of

proof rather than hear the motion in the middle of the trial day. These measures, strictly enforced, will help prevent the disputed evidence from being “inadvertently” elicited in the jury’s presence.

7.5.1.2 Motion to Bar Presentation of Embodying Products as Physical Exhibits

A more extreme version of the motion discussed above is to ask the court to bar introduction of the embodying product as a physical exhibit. The movant typically argues that the embodying product should be excluded under Federal Rule of Evidence 403 because it has no probative value for infringement, but this risks confusing the jury and resulting in an improper infringement analysis. The party seeking to offer the embodiment as a physical exhibit typically responds with one of two arguments. One typical argument is that the sample is relevant to an issue other than infringement. For example, a patentee might argue that the physical sample is a prototype corroborating pre-filing development work and is thus highly relevant to the patent’s priority date, which is in turn relevant to invalidity. Another typical argument is that a physical embodiment will help the jury understand the technology and thus understand the infringement and invalidity issues that it will have to decide.

Even if the embodying product has no legal relevance, this does not mean that it should be excluded, *per se*. The court should not discount the importance of providing the jury with a mechanism that will help it understand the technology and technical issues in dispute. It is entirely appropriate to admit a physical sample for this purpose. Whether the physical sample in question will help illuminate the relevant technical issues for the jury depends entirely on the context in which it is offered. In addition to evaluating the difficulty of the technology and the issues in dispute, the court may find it helpful to evaluate the quality of the other tools offered to the jury. The court should attempt to gauge the jury’s response to these tools before admitting this evidence solely for understanding the surrounding technology. As a result, the court should consider deferring resolution of the motion until it is in a position to evaluate these factors.

7.5.1.3 Motion to Bar Evidence that the Accused Infringer Has Patents of Its Own

This motion is brought by the patentee to prevent the accused infringer from introducing its own patents into evidence. The typical argument is that there is no legitimate purpose for introducing the patents because they are not relevant to any disputed issue. Thus, their introduction is a “frolic and detour” that will waste time. Moreover, the argument typically points to the risk that the jury will be confused by the introduction of the new patents and the technologies they claim. This risk is heightened dramatically, patentees typically argue, when the patents in question claim improvements over the patent being asserted (e.g., the asserted patent claims a car with round wheels and the improvement patents claim a car with round *rubber* wheels). In such a case, there is a risk that the jury will misinterpret the existence of

an improvement patent as grounds for finding no infringement. Juries can fail to grasp the fundamental concept that multiple patents can cover a single product, and thus fail to appreciate that the existence of an improvement patent does not shield its holder from liability for infringement of a more basic patent. *See, e.g., Bio-Tech. Gen. Corp. v. Genentech, Inc.*, 80 F.3d 1553, 1559 (Fed. Cir. 1996).

Of course, this argument founders if the accused infringer identifies a legitimate purpose for introducing its own patents. For example, a patent in which the accused infringer described its products as being different from the asserted patent may be relevant to the reverse doctrine of equivalents or to a lack of the intent required for inducement. In addition, the figures or description contained in an accused infringer's patent may help the jury understand aspects of the accused products better than any other piece of evidence available. This may be important where the technology is particularly complex or abstract.

Depending on the argument for relevance advanced by the accused infringer, the court may benefit from deferring the motion until some evidence has been elicited so that it may better gauge whether the purpose advanced is legitimate or pretextual. If legitimate, the court can head off jury confusion by including in its instructions the admonition that a patent gives its holder the right to exclude others from making the invention, not the right to practice it, and illustrating this point with concrete examples.

7.5.1.4 Motion to Bar Argument that Patent Is Not Infringed Because It Is Invalid

In this motion, the patentee seeks to prevent the accused infringer from arguing that it does not infringe the patent because the patent is invalid or unenforceable. Infringement and validity are separate issues that should be decided separately. *See, e.g., Cardinal Chem. Co. v. Morton Int'l*, 508 U.S. 83, 96 (1993); *Spectra-Physics, Inc. v. Coherent, Inc.*, 827 F.3d 1524, 1535 (Fed. Cir. 1987); *see also MedImmune, Inc. v. Genentech, Inc.*, 549 U.S. 118, 131 n.10 (2007). Likewise, infringement and enforceability are distinct issues. *Gardco Mfg., Inc. v. Herst Lighting Co.*, 820 F.2d 1209, 1213 (Fed. Cir. 1987). As a result, this motion should be granted.

7.5.2 Untimely Disclosures

The second constellation of frequently made motions *in limine* concerns evidence that is asserted to have been disclosed in an untimely fashion. Untimely disclosures, whether relating to documents, expert opinions, or fact witnesses, are certainly not unique to patent cases. Indeed, tardy disclosures in patent cases often result from the same root causes, and have the same effects, as tardy disclosures in other cases. But one characteristic sets patent cases apart—the relativity of the parties' basic contentions.

In patent cases, there is a fundamental tension between infringement and invalidity: the broader the claim, the more likely it is to be infringed, but the less likely it is to be valid, and vice versa. This tension causes parties to take positions that are

relative to the other party's positions. For example, a defendant may argue that an asserted claim does not cover its products because claim limitation X is different from product element Y, but that if Y is within the scope of X as the patentee asserts, then the claim is invalidated by prior art that also contains element Y. Likewise, a patentee may argue that a claim element is missing from a prior art reference, but if present as the defendant asserts, additional products containing that element infringe. More subtly, the products and prior art at issue determine which disputes are joined at the claim construction, summary judgment, and trial stages. As a result, the discovery (or exclusion from evidence) of a single prior art reference, for example, may fundamentally affect the invalidity and infringement arguments of both parties. For this reason, several jurisdictions have established local rules that require parties to exchange infringement and invalidity contentions at certain points during discovery. *See* Appendix D (summary of districts with Patent Local Rules or standard practices that affect patent cases). Courts in jurisdictions that have not adopted such rules should consider implementing similar procedures through a standing or scheduling order.

The relativity of the parties' contentions affects the way that courts should evaluate and redress complaints of untimely disclosed evidence in several ways. First, it is important that the court resolve these motions as quickly as possible—in any event before opening statements. Whether a belated disclosure is justifiable and/or excusable depends on facts that should be available to the court before trial, and so trial evidence is not likely to shed light on the proper result. Moreover, because the admission or exclusion of the evidence could fundamentally alter both parties' trial strategies, it is important that the court resolve such disputes before the parties lay out their trial themes during opening statements.

Second, a seemingly untimely disclosure may be justified in light of the circumstances. For example, the discovery and production of a prior art reference on the day before discovery closes may be timely, depending on the court's rules, but it also may warrant supplementation of interrogatory responses or disclosure of additional evidence by the opposing party after discovery closes. In cases in which the court holds claim-construction proceedings after discovery closes, an unexpected construction may trigger a cascade of new contentions and evidence.

A third, related, point is that the court should treat each belated disclosure independently. Indeed, it is often inequitable to treat both parties' disclosures the same way. For example, one party's belated expert report may be justified in light of the circumstances, while the opposing party's belated report is unjustified. Not only would applying parity to this situation be unfair, but the addition of new facts may also create new inequities. Instead, the court should first determine which belated disclosures, if any, will be excused, and then evaluate what, if any, remedial disclosures are necessary to prevent prejudice to the receiving party. For example, the court may find that it is equitable to allow a party to rebut the other party's belated report, but not to allow it to supplement its existing reports on other issues.

Finally, although the standards for disclosure vary between districts, a court should remember that the general purpose of infringement contentions and invalidity contentions is not to provide a level of detail on par with an expert report. *See, e.g.,*

Fenner Invs., Ltd. v. Hewlett-Packard Co., 2010 U.S. Dist. LEXIS 17536, 2010 WL 786606 (E.D. Tex. Feb. 26, 2010). Rather, the purpose of infringement and validity contentions is to provide notice of infringement and invalidity theories and identify evidence sufficient to illustrate how the party intends to apply those theories to the evidence, with the full scope of proof and evidence of infringement and invalidity being set forth in expert reports—prepared and served after the completion of fact discovery. *Id.*

With these principles in mind, we turn to three commonly filed motions *in limine* arising from belated disclosures.

7.5.2.1 Motion to Preclude Undisclosed Fact Witnesses

This motion seeks to exclude witnesses identified on a party's trial witness list who were not disclosed in that party's initial/supplemental disclosures or interrogatory responses. It largely implicates the same issues as do similar motions in other types of cases and should typically be handled the same way. The court should nevertheless consider the above discussion in evaluating whether the witness disclosure was timely in light of the circumstances.

7.5.2.2 Motion to Preclude Undisclosed Prior Art

In evaluating a patentee's motion to exclude undisclosed or belatedly disclosed prior art, the court should be aware of at least two patent-specific issues. The first, which derives from the Patent Act itself, is that an accused infringer must disclose the prior art that it intends to assert at trial at least 30 days prior to the first day of trial. § 282(c).⁵ The second is the substantial effect that admitting or excluding even one reference could have on the litigation. These issues are discussed in turn.

Accused infringers attempting to inject new prior art into evidence after the close of discovery typically invoke § 282(c) as justification for allowing the reference despite the late disclosure. Patentees typically respond that § 282(c) does not excuse compliance with federal rule, local rule, and court-imposed deadlines. Patentees have the better argument. “[A]lthough § 282 sets a minimum period for the identifi-

5. Section 282(c) provides, in pertinent part, that:

In an action involving the validity or infringement of a patent the party asserting invalidity or noninfringement shall give notice in the pleadings or otherwise in writing to the adverse party at least thirty days before the trial, of the country, number, date, and name of the patentee of any patent, the title, date, and page numbers of any publication to be relied upon as anticipation of the patent in suit or, except in actions in the United States Court of Federal Claims, as showing the state of the art, and the name and address of any person who may be relied upon as the prior inventor or as having prior knowledge of or as having previously used or offered for sale the invention of the patent in suit. In the absence of such notice proof of the said matters may not be made at the trial except on such terms as the court requires.

cation of prior art to be introduced as evidence of anticipation, a specific judicial directive for the timing of discovery establishes the procedures to which the parties are bound.” *ADT Corp. v. Lydall, Inc.*, 159 F.3d 534, 551 (Fed. Cir. 1998). Thus, the court should evaluate this failure to comply with its discovery schedule through the same lens as it would any other transgression to determine whether the circumstances justified the belated disclosure.

Accused infringers attempting to excuse a failure to serve a § 282(c) disclosure complying with the statute typically argue that the prior art was disclosed sufficiently through earlier discovery responses. Patentees typically argue that this is insufficient because compliance with judicially established deadlines cannot excuse a failure to comply with a statutory requirement. The patentees typically have the better of this argument, too, although it can be a much closer case. A failure to comply with § 282(c) may be grounds for exclusion, even if the prior art was produced in discovery or identified in discovery responses. *Ferguson-Beauregard v. Mega Sys. LLC*, 350 F.3d 1327, 1347 (Fed. Cir. 2003). But exclusion is not required. *See, e.g., Eaton Corp. v. Appliance Valves Corp.*, 792 F.2d 874, 879–80 (Fed. Cir. 1986); *but see Applera Corp. v. MJ Research, Inc.*, 389 F. Supp. 2d 344, 351 (D. Conn. 2005) (excluding prior art for failure to comply with § 282 and noting that the Federal Rules have tightened since *Eaton* was decided). In this situation, the court should measure whether the purpose of the rule—that the patentee be advised that the prior art will be *asserted at trial*—has been served. *Eaton*, 792 F.3d at 879 (“What counts is notice of intent to rely.”). If the patentee knew of the accused infringer’s intent to rely on the art at trial, then it *may be* equitable, depending upon the circumstances, to excuse the failure to comply with § 282(c). For example, in a jurisdiction that requires invalidity contentions by local rule, it does not seem equitable to require a later document specifically titled “Section 282 Notice” to admit a prior art reference that had been identified earlier in the case as part of those contentions. A court may well find that the invalidity contentions serve the purposes of the statute.

This motion implicates broader issues, as well: whether the belated disclosure is justifiable in light of some action on the part of the patentee or the court, and the extent to which allowing the reference will have downstream effects. Like a newly disclosed theory of infringement, a newly identified prior art reference could potentially drive the parties to refine or outright alter their positions on any issue, to add or drop claims, and to affect expert testimony presented at trial. As a result, allowing the addition of even one new prior art reference after the close of discovery can trigger a cascade of new evidence or arguments. For example, a new piece of prior art asserted as part of a combinatorial obviousness attack can require new arguments about motivations to combine, secondary considerations of nonobviousness, and the proper application of *Georgia-Pacific* factors in a damages analysis. This, in turn, can cause experts to stray beyond the bounds of their reports (to comment on evidence presented at trial) and can spawn a whole host of related evidentiary issues. In light of this follow-on effect, the court might reasonably require substantial justification before excusing the belated disclosure of prior art.

On the other hand, allowing supplemental art can be an appropriate remedy to counterbalance discovery violations on the part of the patentee. For example, in

many cases patent owners will (either with or without permission) change their infringement theories after claim construction, during expert depositions (and after expert reports), or as trial approaches. Where those changes have been either allowed or tolerated, it might be appropriate to allow the defendant to inject new prior art into the proceedings. This is true because, in many cases, a defendant's invalidity theory will depend on how the plaintiff intends to read the asserted claims on the accused product. Late changes to an infringement theory present particular difficulties where the defendant intends to make a "practicing the prior art" defense. The equities will vary with every fact pattern, so there is no "best" approach other than to consider carefully how the decision is likely to affect the trial as a whole.

7.5.2.3 Motion to Preclude Untimely Expert Opinions

The third type of commonly filed motion centers around whether and to what extent experts are permitted to testify at trial beyond the expert reports prepared according to the schedule set forth in Federal Rule of Civil Procedure 26 or by the court's scheduling order. Typically, this motion comes in one of three forms.

7.5.2.3.1 Opinions Not Disclosed in Reports

The first variant seeks to preclude experts from testifying about issues that were not identified in any timely served report. Commonly, these opinions come to light through a declaration filed in support of a summary judgment motion or a supplemental report served after the close of expert discovery.

Although the court should address this type of motion as soon as possible, many courts do not address the untimeliness of opinions included in summary judgment declarations at the summary judgment stage. Instead, they keep silent on the issue or explicitly defer a ruling until later in the case. The danger in this approach is that it effectively decides the issue in favor of admissibility: without guidance from the court, the receiving party deposes the expert, the prejudice argument is weakened, and the court ultimately allows the opinions, either alone or in connection with a trade-off that allows both parties to disclose opinions outside the normal schedule. Although a one-for-one exchange of reports may appear fair on its face, for the reasons discussed above, it may significantly handicap the receiving party. It also allows the disclosing party to circumvent the court's schedule and undermines the court's ability to manage its docket.

When belated opinions are styled as "supplemental reports," the danger is that the court will treat supplemental reports as interchangeable and adopt an "all-in or all-out" approach. While sometimes appropriate, this approach risks significant prejudice—the scope of opinions set forth in supplemental reports may differ significantly, one report may have downstream effects while the other does not, and one belated disclosure may be justified while the other is not.

7.5.2.3.2 Affirmative Opinions Disclosed in Rebuttal Reports

The second variant seeks to exclude affirmative opinions that were disclosed for the first time in “rebuttal” reports served pursuant to Federal Rule of Civil Procedure 26(a)(2)(C) or the court’s scheduling order. As Rule 26(a)(2)(C) states, these “rebuttal” disclosures are made “solely to contradict or rebut” expert opinions disclosed by the other side. Thus, it is clearly improper to label affirmative opinions as “rebuttal” in nature and to evaluate them under that standard. Instead, the court should treat such disclosures for what they are: “supplemental” opinions, which should be evaluated according to the principles set forth in § 7.5.2.3.2.

7.5.2.3.3 Limit Experts to Their Reports

The third variant seeks to prevent experts from testifying on direct examination about opinions that go beyond their reports. In principle, this motion should be granted. But, in practice, it is often difficult to draw a clear line. On the one hand, experts should not be limited to a recitation of their reports. On the other hand, the more flexibility the expert has to restate her opinions, the more likely it is that the ultimate opinion will contain substantive differences that prejudice the other party. Furthermore, context can be important to discern which departures from the report are appropriate and which are not.

For these reasons, the court should attempt to resolve this motion early, but may need to defer decision concerning certain issues until trial. Rather than grant a blanket motion stating that experts are limited to reports, which will encourage objections during the expert’s testimony, the court should address this general subject on an issue-by-issue basis. It can do so in several ways. First, if a party has concerns directed at certain issues—e.g., a function-way-result analysis of potential equivalents—before trial, the party should be required to brief these issues specifically in its motions *in limine*. If specific concerns arise during trial, but before the expert is put on the stand (e.g., through exchange of graphics or witness binders), the party opposing the testimony should be required to raise the issue in advance, outside the presence of the jury, to allow the court to evaluate the issue before the expert is called to testify. Finally, parties calling an expert should be encouraged to resolve potential disputes in advance. One way to do so would be to require an expert to move on to a completely different subject when an objection about scope is made so that the objection can be resolved outside the presence of the jury. By implementing these procedures, the court can prevent surprise testimony and reduce the number of disputes that are joined in the jury’s presence.

7.5.3 Precluding Claims/Defenses

A third constellation of motions seeks to preclude a party from presenting evidence concerning a particular claim or defense. Four examples illustrate common issues:

Doctrine of Equivalents: The accused infringer brings a motion to preclude the patentee from presenting any evidence concerning the doctrine of equivalents. The

thrust of the argument is often that there is no expert testimony (or no expert testimony that is sufficiently detailed to be admissible, *see* § 7.4.3.3.1) explaining why the element of the accused product has “insubstantial differences” from the relevant claim limitation. Without such testimony, so the argument goes, there is no evidence to show that the differences are insubstantial and, therefore, no way to prove infringement under the doctrine of equivalents. Thus, evidence or argument directed at the doctrine should be precluded as prejudicial and likely to confuse the jury.

Prosecution History Estoppel: Another common motion is predicated on prosecution history estoppel. Under that doctrine, a plaintiff who makes a narrowing amendment during prosecution is barred from relying on the doctrine of equivalents to “recapture” the scope that he surrendered. *See Trading Techs. Int’l, Inc. v. eSpeed, Inc.*, 595 F.3d 1340, 1355 (Fed. Cir. 2010) (“Under prosecution history estoppel, a patentee may not seek to recapture as an equivalent subject matter surrendered during prosecution.”); *PODS, Inc. v. Porta Stor, Inc.*, 484 F.3d 1359, 1367 (Fed. Cir. 2007) (“prosecution history estoppel limits the range of equivalents available to a patentee by preventing recapture of subject matter surrendered during prosecution of the patent”) (internal citations omitted). In many cases, prosecution history estoppel arises when an applicant adds a limitation in an attempt to distinguish prior art. It can also arise, however, where an applicant makes an express disclaimer of claim scope in an argument to the examiner. *See Medtronic Inc. v. Guidant Corp.*, 465 F.3d 1360, 1373 (Fed. Cir. 2006) (“unmistakable assertions made to the Patent Office in support of patentability can give rise to a surrender for purposes of the recapture rule”) (internal citations omitted).

Obviousness: The patentee brings a motion to preclude the accused infringer from presenting evidence that a claim is obvious in light of one or more prior art references. Typically, the patentee makes one of two arguments:

- that the accused infringer identified no evidence that one of ordinary skill in the art had a motivation to combine the references (note that evidence of a specific motivation to combine reference for obviousness purposes is no longer required, although the Supreme Court has stated that it may be helpful to the analysis; *see KSR*, 550 U.S. at 418; *see also* § 14.3.5.2); or
- that the accused infringer identified no adequate expert testimony to explain the elements of obviousness. Thus, evidence or argument directed at the specific obviousness combination—or obviousness generally—would be irrelevant, prejudicial, and likely to confuse the jury. But note that obviousness is a legal issue that does not always require expert testimony, although it may be helpful. *Moleculon Res. Corp. v. CBS, Inc.*, 793 F.2d 1261, 1270 (Fed. Cir. 1986) (argument that expert testimony is required “borders on the frivolous”).

Damages: The accused infringer brings a motion to preclude any evidence of damages prior to the filing of the lawsuit (or the date on which the patentee provided notice of the patent, if earlier). Typically, the accused infringer argues that § 287 bars pre-notice damages unless the patentee marks products covered by the patent with the patent number, and that the patentee has identified no evidence of the required “marking.” Therefore, evidence concerning pre-notice damages would be irrelevant

and prejudicial. The patentee may argue in response that a reasonable royalty analysis depends on the “time of first infringement,” and pre-notice activities must be addressed as part of that analysis.

As these examples illustrate, there is often no clean line between a true motion *in limine* and a summary judgment motion in disguise. One way to resolve this question is to focus on the differences between the motion *in limine* and summary judgment processes. At the summary judgment stage, the briefs are longer, contain more factual detail, and present a fuller explication of the relevant legal standards than at the motion *in limine* stage. Likewise, summary judgment arguments tend to be longer, and the court typically takes much more time to resolve a summary judgment motion than it does a motion *in limine*. When presented with a borderline motion *in limine*, the court should consider whether the issue would benefit from fuller examination. In most cases it will and the court should deny the motion. See *Kimball ex rel. Kimball v. RJ Reynolds Tobacco Co.*, 2006 U.S. Dist. LEXIS 27138, 2006 WL 1148506 (W.D. Wash. Apr. 26, 2006) (“The court assumes that counsel is aware of the differences between dispositive motions and motions *in limine*. The court is thus surprised and disappointed to find numerous dispositive motions pending only days before trial.”).

Merely denying the motion, though, deprives the court of an opportunity to weed out issues for which a party will not be able to carry its burden of proof. As a result, the court should advise parties during the initial case-management conference that it will treat certain exclusion/preclusion motions, such as those identified above, as summary judgment motions. See § 2.5; Appendix 2.1; Appendix 2.2a. With fair warning, parties may elect to bring these motions at the summary judgment stage, giving the court an opportunity to resolve these disputes with adequate time for evaluating the record.

7.5.4 Miscellaneous Patent-Related Motions

In addition to the three constellations of motions discussed above, several other motions *in limine* with patent-specific implications arise in many cases.

7.5.4.1 Motion to Bar Evidence/Argument Inconsistent with Claim Construction

This motion can be brought by either party and asserts that the opposing party seeks to reargue, or present evidence that conflicts with, the court’s construction of a particular claim term. Typically, the moving party argues that claim construction is an issue of law to be decided by the court and that arguing or presenting inconsistent evidence to the jury intrudes into the province of the court. Consequently, the argument goes, a party should not be permitted to ask the jury to construe a claim term or to present evidence that clearly implicates a contrary construction.

Taken at face value, the movant’s argument is sensible—claim construction is a legal exercise that must be performed by the court. See *Markman v. Westview Instruments, Inc.*, 517 U.S. 370, 391 (1996); § 5.2. This motion is often more complicat-

ed, however, because parties also employ this reasoning to exclude legitimate arguments and evidence directed at issues that do not rely on claim construction. For example, a written description defense is premised on a comparison between the construed claim and the originally filed specification to determine whether the patentee was in possession of the claimed invention at the time the application was filed. *See, e.g., Moba, B.V. v. Diamond Automation, Inc.*, 325 F.3d 1306, 1320–21 (Fed. Cir. 2003). Even if an accused infringer were to argue that the inventor was not in possession of the invention as claimed because the construed claim lacks a limitation corresponding to a feature of the embodiments discussed in the specification, the jury should not rewrite the court’s claim construction, at least expressly. The argument is directed to a different issue. Likewise, a noninfringement defense based on the reverse doctrine of equivalents is premised on a comparison of the accused product to the originally filed application. *See, e.g., Scripps Clinic & Research Found. v. Genentech*, 927 F.2d 1565, 1581 (Fed. Cir. 1991). Therefore, an accused infringer offering evidence of that comparison is not seeking to rewrite the court’s claim construction, but rather to satisfy a different legal standard.

Because the argument that an alleged infringer is seeking to diverge from the court’s claim construction is so easily used to thwart a genuine defense, it is important that the court evaluate carefully whether there is a legitimate purpose for introducing the evidence or making the argument, and not simply take the motion at face value. Moreover, because the decision may have far-reaching effects (especially if the court’s ruling has the effect of precluding a defense), the court should rule on this motion before trial begins.

7.5.4.2 Motion to Preclude Reference to an Expert’s Contrary Claim-Construction Opinion

Experts in patent cases are often asked to provide opinions at multiple stages in the case. They will, for example, often be asked at the claim-construction stage to offer an opinion directed to explaining how a person having ordinary skill in the art would have understood a term at the time the patent application was filed. Once the court has construed the claims, the experts will be asked at the “expert discovery” stage to offer opinions applying the court’s construction to reach conclusions related to infringement and validity. When multiple experts offer conflicting opinions about claim construction, at least one expert’s opinion is necessarily at odds with the court’s ultimate construction.

This motion is brought to prevent one party from cross-examining the other party’s expert based on statements made to support a losing claim-construction position. Typically, the argument is that the opinion has no relevance to infringement or validity. Moreover, the jury is likely to misunderstand why the expert is “changing” positions—because she must apply the court’s construction—and might unfairly discount the expert’s credibility. One counter-argument is that the substance of the claim construction reveals inconsistencies beyond the meaning applied to the claim term. For example, an expert might opine at the claim-construction stage that a prior art technique was widely known, but opine later in the case that the technique was

known only to a few artisans. In this example, the inconsistency—and the blow to credibility—has nothing to do with the ultimate conclusion that the expert reached about claim construction; the testimony is simply inconsistent. As a result, the court should consider allowing the use of such prior opinions based on a case-by-case balancing of probative value and potential prejudice. In some instances, the court should consider deferring decision on the motion until the direct examination of the expert is complete so as to better appreciate the import of the alleged inconsistency.

7.5.4.3 Motion to Bar Evidence/Argument About Dropped Claims/Patents

This motion is brought by the patentee and seeks to preclude any reference to the fact that the patentee initially asserted more claims or patents than it is pursuing at trial. Typically, the patentee argues that the claims/patents were dropped for efficiency and that this change does not reflect the merits of the liability arguments concerning those claims/patents in any way. As a result, the argument goes, this fact has no probative value. Moreover, there is a substantial risk of prejudice because the jury is likely to assume that the claims were dropped because the patentee believed them to be invalid or not infringed.

Accused infringers typically argue that the fact that the patentee dropped claims or patents does have probative value, at least when willful infringement or an antitrust counterclaim is asserted. In the former situation, the fact that the patentee initially asserted additional/different patents or claims before pursuing the patents/claims asserted at trial may affect the reasonableness of the accused infringer's response. Therefore, as the argument goes, this fact is relevant to whether the accused infringer reasonably believed that it had a right to continue its allegedly infringing conduct. In the antitrust counterclaim scenario, the counterclaim plaintiff may seek to show that the patentee has engaged in an unwarranted campaign to instill fear, uncertainty, and doubt into the marketplace by falsely asserting patent infringement.

There is no clear-cut way to resolve this motion. The outcome is highly fact-dependent. The accused infringer may in some cases legitimately seek to use the information to rebut willfulness or for some other purpose. Even so, this motion should be decided before opening statements. In most cases, waiting for testimony to be elicited during trial will not provide additional clarity about which side has the better argument. For antitrust counterclaims, this issue weighs in favor of bifurcating the trial (affirmative patent infringement claims tried first; antitrust counterclaims addressed in a second trial phase) so as to avoid confusing the jury.

7.5.4.4 Motion to Bar Disclosure that the Patentee Seeks an Injunction

This motion is brought by the patentee and seeks to preclude any evidence or argument to the jury disclosing that the patentee seeks an injunction. Because a request for an injunction seeks equitable relief, it is decided by the court, rather than

by the jury. Typically, the patentee argues that disclosing the request for an injunction has no probative value and would prejudice the plaintiff by potentially generating sympathy that could affect the jury's decision on liability. The accused infringer often responds that mentioning the possibility of an injunction is no more prejudicial than disclosing the size of the damages award sought (which, of course, is disclosed, unless the case is bifurcated), and that the information may be relevant to other issues in the case, such as the accused infringer's state of mind for willfulness (e.g., that the accused infringer evaluated the patent seriously because it knew the plaintiff would be seeking an injunction). If the relevance to an issue before the jury is shown, the motion should generally be denied. But the court should evaluate the motion carefully to discern whether, given the specific facts of the case, the risk of prejudice trumps the probative value of the argument or evidence.

7.5.4.5 Motion to Preclude Reference to Related Proceedings in the Patent Office

This motion is often, although not always, brought by the patentee who seeks to preclude any reference to a pending reexamination or reissue involving the patent-in-suit. Typically, the argument is that the parallel proceedings have no relevance until they are completed—when the claims are ultimately issued intact, modified, or rejected. Moreover, there is considerable risk that the jury will misunderstand the significance of the proceedings and will inappropriately weigh this evidence. In response, the opposing party typically counters that the parallel proceeding has substantial probative value concerning invalidity or inequitable conduct. For example, if the Patent Office decides to reexamine the patent-in-suit because of a particular prior art reference, that fact supports the argument that the reference is material, which is relevant to inequitable conduct. Conversely, if the Patent Office reissued a patent over a prior art reference, this supports the argument that the reference is not material. *See, e.g., Bristol-Myers Squibb Co. v. Rhone-Poulenc Rorer, Inc.*, 326 F.3d 1226, 1237 (Fed. Cir. 2003).

One common dispute that has arisen since the passage of the AIA concerns the admissibility of Patent Trial and Appeal Board (PTAB) decisions to institute, or not institute, an *inter partes* review (IPR) or covered business method review (CBMR). In this context, a patentee typically argues that a non-institution decision is probative of the patent's validity because the standard for institution (effectively, more likely than not that one or more claims is invalid) is lower than the burden for proving invalidity at trial (clear and convincing evidence of invalidity). While this argument has some surface appeal, its ultimate persuasiveness depends on the specific positions being advanced before the district court in comparison with those advanced in the IPR/CBMR petition. It is strongest where the prior art and positions being advanced at trial overlap exactly with those made in the IPR/CBMR petition; it is weakest where the prior art and positions do not overlap at all. Where, as in most cases, there is some but not complete overlap, the district court should conduct typical Rule 403 balancing based on the specific facts. Weighing the factors, district courts have come down on both sides of admissibility. Some permitted the patentee

to refer to the denial. *See, e.g., Universal Elecs. Inc. v. Universal Remote Control Inc.*, 2014 U.S. Dist. LEXIS 182754, 2014 WL 10253110 (C.D. Cal. Apr. 21, 2014) (denying defendant’s motion *in limine* to preclude any evidence regarding the USPTO’s decision not to institute *inter partes* review of one of the patents-in-suit and rejecting defendant’s argument that “introducing evidence of the PTO’s rejection of [d]efendant’s *inter partes* review petition would be irrelevant because the legal standards applicable to an *inter partes* review are different than those that apply here, and that it would increase the complexity of the trial and confuse the jury” because “[a]ny potential confusion can be addressed by appropriate jury instructions on the standard of proof applicable to patent invalidity defenses and counterclaims.”). Others precluded the use of the IPR/CBMR denial. *See, e.g., Rembrandt Wireless Techs., LP v. Samsung Elecs. Co., Ltd.*, 2015 U.S. Dist. LEXIS 20306, *19, 2015 WL 627430 (E.D. Tex. Jan. 30, 2015); *Interdigital Commc’ns, Inc. v. Nokia Corp.*, 2014 U.S. Dist. LEXIS 182856, 2014 WL 8104167 (D. Del. Sept. 19, 2014) (holding that the PTAB’s decision not to institute trial—“made by lawyers who are not persons of ordinary skill in the art”—was of marginal relevance and should be excluded under Federal Rule of Evidence 403).

Courts typically preclude defendants from referencing decisions to institute IPR/CBM proceedings on the basis that a finding that one or more of the claims is likely invalid says little or nothing about whether there is clear and convincing evidence that the patent is invalid. *See, e.g., Intellectual Ventures I LLC v. Symantec*, 2015 U.S. Dist. LEXIS 2841, at *3, 2015 WL 82052 (D. Del. Jan. 6, 2015). But in both the institution and noninstitution contexts, courts should distinguish between allowing a party to reference the Patent Office’s decisions or the existence of the IPR/CBMR process on the one hand from referencing statements made by a party (whether the patentee or the challenger) on the other hand. For example, even where a court elects to preclude a defendant from mentioning the existence of an IPR or reexamination proceeding, the purpose of that proceeding, or decisions by the Patent Office or PTAB during that proceeding, courts should—and typically do—permit the defendant to introduce statements made by the patentee in the course of those proceedings that bear on arguments being made by the parties in litigation. *See, e.g., id.* (precluding reference to reexamination proceedings but permitting introduction of “portions of the reexamination history or us[e] of same for impeachment, provided, however, that such evidence or use must be done in such a way as not to reference any reexamination”).

Regardless of the district court’s initial posture as to the use of materials related to, requested for, or instituted during post-issuance proceedings, a party might introduce evidence or make arguments that could open the door to their use at trial. For example, a patentee’s statements about prior art already having been considered by the Patent Office or excessive discussion of the presumption of validity *might* open the door to evidence showing that asserted claims currently stand rejected by the Patent Office or the PTAB in view of prior art asserted at trial. Likewise, a defendant’s statements about the Patent Office not having all the relevant information, or having not considered a specific prior art reference, during the original prosecution *might* open the door for the patentee to present evidence showing that the

PTAB denied a request to institute an IPR on the prior art asserted at trial. But in all cases, whether the statements genuinely open the door to the use of the material depends on precisely what was argued or presented and precisely how the material proffered rebuts that evidence or argument. In other words, it is highly fact-specific.

As this discussion illustrates, evidence related to post-issuance Patent Office proceedings will often have some probative value, but also some potential for prejudice. Accordingly, the court should consider carefully what evidence relating to the parallel proceedings can be used and for what exact purpose. In many instances, this judgment may be better informed once trial has begun, when the court can evaluate the precise context in which the evidence will be presented.

7.5.4.6 Motion to Preclude Evidence Concerning Undisclosed Opinions of Counsel

When it enacted the AIA in 2011, Congress revised § 298 to specify that

The failure of an infringer to obtain the advice of counsel with respect to any allegedly infringed patent, or the failure of the infringer to present such advice to the court or jury, may not be used to prove that the accused infringer willfully infringed the patent or that the infringer intended to induce infringement of the patent.

In light of this provision, the court should grant a motion *in limine* that seeks to exclude evidence that an accused infringer failed to obtain, or to disclose in the litigation, an opinion of counsel regarding the asserted patent, when that evidence is proffered for the purpose of establishing willful infringement or indirect infringement. If such evidence is proffered for some other purpose, the court should weigh carefully whether the asserted probative value of such evidence outweighs the prejudice that led Congress to enact this prohibition.

7.5.4.7 Motion to Preclude Evidence Based on Estoppel Resulting from Postgrant Proceedings

In the AIA, Congress enacted two new postgrant proceedings to replace *inter partes* reexaminations: postgrant reviews (which must be filed within nine months of issuance or reissuance of a patent) and *inter partes* review. Both new proceedings carry with them provisions that estop the party that brought them against the patent (or the real party in interest or privy) from asserting—either in a civil action in district court or in an action brought before the International Trade Commission—“that the claim is invalid on any ground that the petitioner raised or reasonably could have raised during that [postgrant review or *inter partes* review].” *See, e.g.,* AIA §§ 315 (*inter partes*), 325 (postgrant); § 14.2.5.8.1. Congress also enacted a third postgrant review process directed at business method patents (covered business method review (CBMR)), which has a more limited estoppel provision: it estops the party bringing the challenge from relitigating any issue that it actually raised in the CBMR. For all of these proceedings, the estoppels take effect once a “final written decision” has been issued in the proceeding. Because these new postgrant proceedings were not instituted until September 16, 2012, the first wave of estoppels arising

from postgrant proceedings was expected in 2014. Because the success rate for instituted proceedings has thus far been high, courts have not yet seen a substantial number of estoppel issues arising from postgrant proceedings. We expect, however, that the incidence of these issues will rise over time.

In the estoppel context, courts are likely to be presented with motions *in limine* brought by a patentee seeking to exclude argument and evidence related to invalidity arguments that were presented, or allegedly should have been presented, during a postgrant proceeding. Resolving motions directed to prior art or other invalidity arguments that were explicitly considered by the Patent Office during the proceeding should be straightforward. Motions directed to prior art or argument that the patentee alleges *should have been* raised during the proceedings will be more difficult. Although no specific standard has yet been delineated, courts should consider, among other facts, whether the basis of invalidity now asserted could actually have been raised in the postgrant proceeding (note that postgrant reviews consider a different universe of invalidity arguments than *inter partes* reviews); whether the prior art or another basis for invalidity was actually known by the requesting party when the request was made; if it was not known, the efforts made to discover bases for invalidity and the difficulty of uncovering, at that time with the resources available, the basis for invalidity now asserted; and whether expert testimony, discovery, positions taken by the patentee during litigation, and other aspects of litigation were reasonably necessary to discover the basis for invalidity or appreciate its significance.

As a practical matter, this last point is especially important. Often in litigation, the accused infringer makes the argument that prior art discloses the asserted patent claims only as those claims are interpreted by the patentee in furtherance of its infringement allegations. In other words, if properly construed, the patent claims cover neither the accused product nor the prior art, but if construed as broadly as the patentee contends, then the patent claims cover the prior art. This type of conditional argument may not arise until litigation because the patentee may not take such positions until well into the case, and long after a request for a postgrant proceeding is filed. Similarly, what diligence may be reasonable to expect of an accused infringer engaged in litigation, for example in the context of preparing patent local rule invalidity contentions, may well be unreasonable to expect of an entity before litigation begins. Conversely, reserving for potential litigation prior art that the accused infringer had identified and knew was significant to the validity of the patent claims at the time it filed the postgrant proceeding request conflicts with the clear purpose of the statute, which is to reduce the likelihood of parallel litigation. As this discussion illustrates, motions of this kind are likely to be fact-intensive. The court should weigh these and other factors pertinent to the given situation and evaluate such motions on a case-by-case basis.

7.5.4.8 Motion to Preclude Reference to Presumption of Validity

As previously noted, it is now generally considered improper to instruct a jury on the presumption of validity aside from instruction on the “clear and convincing” burden of proof. *See* § 7.3.4.3. For this same reason, defendants often ask courts to

enter an order forbidding a plaintiff from mentioning the presumption of validity. The court has broad discretion to decide for itself whether such a reference is likely to be confusing or to undermine the court's efforts to clarify concepts through its jury instructions. Courts have granted this motion to align better the arguments presented by the attorneys with the court's jury instructions. *See, e.g., Alloc, Inc. v. Pergo, Inc.*, 2007 U.S. Dist. LEXIS 5183, 2007 WL 5289735 (E.D. Wis. Nov. 21, 2007) ("In the interest of making concepts as clear to the jury as possible, the court will direct that the parties refrain from referring to the 'presumption of validity,' since the parties may refer to the same concept as the Alloc Parties' burden of proof."); *Voda v. Cordis Corp.*, 2006 U.S. Dist. LEXIS 97321, 2006 WL 5347777 (W.D. Okla. May 10, 2006) ("The court will instruct the jury on the appropriate burden of proof. Defendant's motion to preclude plaintiff from referring to the presumption of validity is therefore GRANTED.").

7.5.4.9 Motion to Preclude Use of "Patent Troll" and Other Pejorative Terms Related to Nonpracticing Entities

As public and political discourse regarding nonpracticing entities expands, evidentiary disputes regarding the propriety of referring to nonpracticing entities as "patent trolls" and related monikers are increasing. District courts will sometimes grant motions to preclude the accused infringer from referring to a nonpracticing entity by such terms. Plaintiffs will typically argue that such references are derogatory, prejudicial, and confusing to the jury. Accused infringers will respond that such terms convey to the jury aspects of a nonpracticing entities' characteristics that are relevant to secondary considerations of nonobviousness and damages calculations.

In a recent case, a district court granted the plaintiff's motion *in limine* to preclude the accused infringer from using at trial the terms "patent troll," "pirate," "bounty hunter," "bandit," "paper patent," "stick up," "shakedown," "playing the lawsuit lottery," "corporate shell game" or "a corporate shell." *GPNE Corp. v. Apple, Inc.*, ECF No. 319 at 2:17-24, No. 5:12-cv-02885-LHK (N.D. Cal. June 24, 2014). The district court also ruled, however, that, at trial, the accused infringer could refer to the plaintiff, the asserted patent, and the patentee's activities as a "nonpracticing entity," "licensing entity," "patent assertion entity," "a company that doesn't make anything" or "a company that doesn't sell anything." Citing Fed. R. Evid. 403, the district court found that its ruling "strikes the balance" between such competing considerations. *Id.* Similarly, the district court in *Intellectual Ventures I LLC v. Symantec Corp.*, ruled that the defendant was precluded from disparaging the plaintiff's business model and practices, but was permitted to present evidence and argument that the plaintiff does not practice the patents-in-suit, "which is relevant to damages" and for which issue the "concerns of Federal Rule of Evidence 403 do not outweigh the probative value of the evidence." 2015 U.S. Dist. LEXIS 2841, 2015 WL 82052 (D. Del. Jan. 6, 2015).

Appendix 7.1 Sample Pretrial Order for Patent Cases

IN THE UNITED STATES DISTRICT COURT
FOR THE _____ DISTRICT OF _____

_____		Civil Action No. _____
Plaintiff,		
vs.		

Defendant.		

PROPOSED PRETRIAL ORDER

[Instructions to parties and counsel provided in this document are enclosed within brackets and should be omitted from the document when the Proposed Pretrial Order is prepared for submission.]

Trial Counsel for the Parties

[Each party shall identify the names, law firms, addresses, telephone numbers, and email addresses for the attorneys who will try the case on behalf of that party.]

Jurisdiction

[The parties shall identify the basis for the Court's jurisdiction.]

Nature of the Action

[The parties shall provide a brief description of the nature and background of the action.]

The Parties' Contentions

[Plaintiff shall provide an identification and brief description of its contentions. In a patent-infringement case, Plaintiff's statement (or in a declaratory judgment action, Defendant's statement) shall include at least the following information:

- (1) The specific patent claims to be asserted at trial (i.e., the set or subset of previously-identified asserted claims);

- (2) The specific products to be accused of infringement at trial (i.e., the set or subset of previously-identified accused products);
- (3) Whether the patentee intends to rely at trial on the doctrine of equivalents to establish infringement for any claim;
- (4) Whether the patentee intends to assert indirect infringement at trial and, if so, under what theory (i.e., contributory infringement and/or inducement) and as to which claims and products;
- (5) The type of infringement damages to be sought at trial (i.e., lost profits, reasonable royalty, or both); and
- (6) If the accused infringer asserts that one or more of the asserted patent claims is obvious, whether the patentee intends to rely on any “secondary indicia” of nonobviousness to rebut this contention and, if so, which specific indicia (e.g., commercial success of _____ (product), recognition as shown by _____ (award), etc.).

Defendant shall provide an identification and brief description of its contentions. In a patent-infringement case, Defendant’s statement (or in a declaratory judgment action, Plaintiff’s statement) shall include at least the following information:

- (7) Whether the accused infringer intends to assert at trial that one or more of its products does not infringe one or more asserted claims; and
- (8) Whether the accused infringer intends to assert at trial that one or more of the asserted patent claims is invalid. If so, the accused infringer shall provide at least the following additional information:
- (9) The specific patents, publications, devices, or other prior art to be asserted at trial as anticipating or rendering obvious one or more of the asserted claims (i.e., the set or subset of previously-identified asserted prior art);
- (10) Whether the accused infringer will assert at trial that one or more asserted claims is invalid under 35 U.S.C. § 101; and
- (11) Whether the accused infringer will assert at trial that one or more asserted claims is invalid under 35 U.S.C. § 112 and, if so, the specific grounds to be asserted (i.e., written description, lack of enablement, and/or indefiniteness).]

Uncontested Facts and Stipulations

[The parties shall identify undisputed facts that are relevant to their contentions, as set forth in Section IV, and stipulations regarding trial procedures (e.g., exchange of demonstratives, disclosure of deposition designations and objections, and the like), the subject matter to be tried, or that otherwise bear on the trial.]

Contested Legal and Factual Issues

[Each party shall identify the specific issues of fact and law that are relevant to their contentions, as set forth in Section IV, and are contested.]

Jury and Non-Jury Issues

[The parties shall identify whether they request trial by a jury or by the Court. If the case is to be tried to a jury, the parties shall identify any equitable, legal, or other issues that they contend should be decided by the Court, through a bench trial or otherwise.]

List of Witnesses

[Each party shall submit with the Proposed Pretrial Order a list of witnesses that it will call or may call at trial, and specify for each such witness: a) whether that witness is expected to testify live or by deposition; b) whether the witnesses will provide factual or expert testimony; and c) any objections that have been made to the witness being called to testify. Plaintiff's witness list shall be submitted as Exhibit 8A to the Proposed Pretrial Order; Defendant's witness list shall be submitted as Exhibit 8B.]

List of Exhibits

[Each party shall submit with the Proposed Pretrial Order a list of exhibits that it may seek to offer into evidence at trial, along with the objections, if any, that have been made to each such exhibit. Plaintiff's exhibit list shall be submitted as Exhibit 9A to that proposed order; Defendant's exhibit list shall be submitted as Exhibit 9B.]

List of Pending Motions

[Each party shall identify the motions that it has filed that remain pending with the Court.]

Jury Instructions

[If the case is to be tried to a jury, the parties shall submit a joint set of preliminary instructions as Exhibit 11A to the Proposed Pretrial Order and a joint set of final instructions as Exhibit 11B to the Proposed Pretrial Order. The Court may use these proposed instructions to charge the jury, or may modify them or use other instructions as is warranted. The parties should exchange proposed preliminary instructions and proposed final instructions in accordance with the Court's scheduling order, and, in any event, well in advance of the submission of the Proposed Pretrial Order. The parties should meet-and-confer as necessary to reach agreement regarding a joint set of instructions. In Exhibits 11A and 11B submitted with the Proposed Pretrial Order, each instruction shall be separately numbered and no more than one instruction may be included on a single printed page (though some instructions may span multiple pages). Where the parties disagree about whether a particular instruction should be given, or about the specific language to be used in an instruction, the party proposing the instruction shall include it in the set, in the place in which it would appear if adopted, with the notation "PROPOSED BY PLAINTIFF [OR DEFENDANT]" and shall provide a brief (i.e., 1 to 2 paragraph) explanation why this instruction should be adopted, including citations to all relevant authority. Immediately following this proposed instruction, the party opposing the instruction shall

include on a separate page a similarly brief explanation why the proposed instruction should not be adopted, including citations to all relevant authority. Where the parties propose competing language for an instruction, this same procedure shall be followed consecutively for each proposed version of the instruction, such that the consecutive pages for that instruction appear as follows: 1) Instruction X, Proposal A; 2) Objection to Proposal A; 3) Instruction X, Proposal B; 4) Objection to Proposal B.]

Verdict Form

[If the case is to be tried to a jury, the parties shall submit as Exhibit 12 to the Proposed Pretrial Order a proposed verdict form. If the parties are unable to agree on a verdict form, each party shall submit a proposed verdict form, along with a short (no more than 2 pages) explanation why its proposed form should be adopted, including citations to all relevant authority. Plaintiff's proposed verdict form and accompanying argument shall be submitted as Exhibit 12A to the Proposed Pretrial Order; Defendant's proposed verdict form and accompanying argument shall be submitted as Exhibit 12B to that proposed order.]

Trial Length and Logistics

[Each party shall specify the number of hours that it contends is appropriate for each party for each of the following: a) voir dire, b) opening statements, c) presentation of evidence, and d) closing arguments. If any party intends to request phasing, bifurcation, or other procedure concerning the trial length or ordering of evidence, that party shall include such request in its statement herein, along with a short explanation of the basis for the request. A party opposing the request may include a similarly short statement explaining briefly its opposition to the request. If the request is the subject of a motion presently pending before the Court, the parties shall identify that request in this section, but omit the short statements concerning that request.]

Dated: _____.

[Counsel Signatures]

Appendix 7.2

Proposed Final Pretrial Order—Patent

(Chief Judge Leonard P. Stark, District of Delaware)

REVISED June 2014

[Note: Throughout, material in brackets is provided as guidance to counsel as to the Court's practices and/or matter that needs to be addressed in the Proposed Final Pretrial Order.]

PROPOSED FINAL PRETRIAL ORDER- PATENT

This matter comes before the Court at a final pretrial conference held pursuant to Rule 16 of the Federal Rules of Civil Procedure.

Plaintiff(s) Counsel: [List name, address, telephone number, and e-mail address]^[6]

Defendant(s) Counsel: [List name, address, telephone number, and e-mail address]^[7]

I. Nature of the Case

[The parties should prepare a brief statement of the nature of the case including identification of the parties and their claims. This statement may be used by the Court to explain the case to prospective jurors during the process of jury selection.]

II. Jurisdiction

This is an action for [state the remedy sought, such as damages or injunctive or declaratory relief].

The jurisdiction of the Court is not disputed [or, if the issue has not previously been raised, the basis on which jurisdiction is contested] and is based on [state the statutory, constitutional, or other basis of jurisdiction].

III. Facts

A. Uncontested Facts

Any party, with prior notice to all other parties, may read any or all of the uncontested facts to the jury or Court, and will be charged for the time used to do so.

The following facts are not disputed or have been agreed to or stipulated to by the parties:

[This section should contain a comprehensive statement of the uncontested facts which the parties intend to make part of the evidentiary record, either by reading to the jury, or in a bench trial reading to the Court and/or filing with the Court in conjunction with posttrial briefing.]

B. Contested Facts

[Identify the facts in issue, with a brief statement of what each party intends

6. For simplicity, "Plaintiff(s)" refers throughout this form order to the party asserting infringement of its patent(s).

7. For simplicity, "Defendant(s)" refers throughout this form order to the party accused of infringement.

to prove in support of its claims and/or defenses. These summaries should be sufficient to identify for the Court the essential facts in issue and to fairly notify the other parties of what counsel expects to prove at trial.]

IV. Issues of Law

[Include a statement of the issues of law which any party contends remain to be litigated, and a citation of authorities relied upon by each party.]

[The Court will preclude a party from seeking relief based on claims and defenses not described in the draft pretrial order.]

V. Witnesses

[Indicate which witnesses will testify in person and which by deposition. Indicate if there are any objections to a witness and, if so, briefly state the basis for the objection.] Any witness not listed will be precluded from testifying, absent good cause shown.

In the absence of an alternative agreement between the parties, fact witnesses will be sequestered. Also, unless the parties reach an alternative agreement, the order of the presentation of evidence will follow the burden of proof.

[The presumptive order of proof is:

Phase I: Plaintiff case-in-chief on infringement and damages

Phase II: Defendant response on infringement and damages, and case-in-chief on invalidity

Phase III: Plaintiff rebuttal on infringement and damages, and response on validity

Phase IV: Defendant rebuttal on invalidity]

A. List of Witnesses the Plaintiff Expects to Call

1. Expert witnesses

[For any expert witness, the Plaintiff shall indicate the precise subject matter on which it will ask the Court to recognize the witness's expertise. At trial, the Plaintiff should offer the witness as an expert on that same subject matter. No deviations as to the described subject matter will be permitted without approval of all parties or the Court, on good cause shown.]

2. Non-expert witnesses

B. List of Witnesses Defendant Expects to Call

1. Expert witnesses

[For any expert witness, the Defendant shall indicate the precise subject matter on which it will ask the Court to recognize the witness's expertise. At trial, the Defendant should offer the witness as an expert on that same subject matter. No deviations as to the described subject matter will be permitted without approval of all parties or the Court, on good cause shown.]

2. Non-expert witnesses

C. List of Witnesses Third Parties Expect to Call

[If there are any third parties to the action, they should include a list of witnesses like those contained in Parts A and B above.]

D. Testimony by Deposition

[Counsel should confer prior to the pretrial conference to determine which testimony will be offered by deposition (including videotape depositions), to agree on

the designation of those portions of the depositions to be offered into evidence, and to identify objections.] This pretrial order contains the maximum universe of deposition designations, counter-designations, and objections to admission of deposition testimony; none of the foregoing shall be supplemented without approval of all parties or leave of the Court, on good cause shown.

If there are objections that remain to be resolved, the party calling the witness by deposition shall, no later than two (2) calendar days before the witness is to be called at trial, submit, on behalf of all parties: (i) a copy of the entire deposition testimony of the witness at issue, clearly highlighting the designations, counter-designations, and pending objections; and (ii) a cover letter clearly identifying the pending objections as well as a brief indication (i.e., no more than one sentence per objection) of the basis for the objection and the offering party's response to it. Failure to comply with these procedures, absent an agreement by the parties and approval by the Court, will result in waiver of the use of the deposition testimony or waiver of objection to the use of the deposition testimony.

All irrelevant and redundant material, including colloquy between counsel and objections, will be eliminated when the deposition is read or viewed at trial.

When the witness is called to testify by deposition at trial, the party calling the witness shall provide the Court with two copies of the transcript of the designations and counter-designations that will be read or played. The parties will be charged for all time that elapses from the time the witness is called until the next witness is called, according to the proportions to be provided by the parties.

E. Impeachment with Prior Inconsistent Testimony

[The parties shall provide their position(s) as to whether the Court should allow objections to the use of deposition and other prior testimony for impeachment purposes, including objections based on lack of completeness and/or lack of inconsistency.]

F. Objections to Expert Testimony

[The parties shall provide their position(s) as to whether the Court should rule at trial on objections to expert testimony as beyond the scope of prior expert disclosures, taking time from the parties' trial presentation to argue and decide such objections; or whether the Court should instead defer ruling on all such objections unless renewed in writing following trial, subject to the proviso that a party prevailing on such a posttrial objection will be entitled to have all of its costs associated with a new trial paid for by the party that elicited the improper expert testimony at the earlier trial.]

VI. Exhibits

A. Exhibits

[The parties are to provide a list of pre-marked exhibits which each party intends to offer at trial, along with citations to the Federal Rules of Evidence to note any objections thereto lodged by any other party.] This pretrial order contains the maximum universe of exhibits to be used in any party's case-in-chief, as well as all objections to the admission of such objections, neither of which shall be supplemented without approval of all parties or leave of the Court, on good cause shown. Exhibits not listed will not be admitted unless good cause is shown.

No exhibit will be admitted unless offered into evidence through a witness, who must at least be shown the exhibit. At some point before the completion of the wit-

ness' testimony, any party that has used an exhibit with the witness and wishes that exhibit to be admitted into evidence must formally move the exhibit into evidence, by exhibit number. Exhibits may not be published, displayed, or otherwise shown to the jury until after they have been admitted into evidence. Once admitted, counsel may publish exhibits to the jury without requesting to do so.

A party will provide exhibits to be used in connection with direct examination by 6:00 p.m. the day before their intended use, and objections will be provided no later than 8:00 p.m. the night before their intended use. If good faith efforts to resolve the objections fail, the party objecting to the exhibits shall bring its objections to the Court's attention prior to the witness being called to the witness stand. Failure to comply with these procedures, absent an agreement by the parties and approval by the Court, will result in waiver of the use of an exhibit or waiver of objection to the exhibit.

Exhibits not objected to will be received into evidence by the operation of the Final Pretrial Order without the need for additional foundation testimony, provided they are shown to a witness.

On or before the first day of trial, counsel will deliver to the Courtroom Deputy a completed AO Form 187 exhibit list for each party.

B. Demonstrative Exhibits

The parties will exchange demonstratives to be used in opening statements by 8:00 p.m. two nights before opening statements. The parties will provide any objections to such demonstratives by 12:00 p.m. (noon) on the day before opening statements.

A party will provide demonstrative exhibits to be used in connection with direct examination by 6:00 p.m. the night before their intended use, and objections will be provided no later than 8:00 p.m. the night before their intended use. If any of the demonstratives change after the deadline, the party intending to use the demonstrative will promptly notify the opposing party of the change(s).

The party seeking to use a demonstrative will provide a color representation of the demonstrative to the other side in PDF form. However, for video or animations, the party seeking to use the demonstrative will provide it to the other side on a DVD or CD. For irregularly sized physical exhibits, the party seeking to use the demonstrative will provide a color representation as a PDF of 8.5 x 11 copies of the exhibits.

This provision does not apply to demonstratives created during testimony or demonstratives to be used for cross-examination, neither of which need to be provided to the other side in advance of their use. In addition, blow-ups or highlights of exhibits or parts of exhibits or testimony are not required to be provided to the other side in advance of their use.

If good faith efforts to resolve objections to demonstrative exhibits fail, the objecting party shall bring its objections to the Court's attention prior to the opening statements or prior to the applicable witness being called to the witness stand. Failure to comply with these procedures, absent an agreement by the parties and approval by the Court, will result in waiver of the use of an exhibit or waiver of objection to the exhibit.

VII. Damages

[Include an itemized statement of all damages, including special damages.]

VIII. Bifurcated Trial

[Indicate whether the parties desire a bifurcated trial, and, if so, why.]

IX. Motions in Limine

Motions in limine shall not be separately filed. All in limine requests and responses thereto shall be set forth in the proposed pretrial order. Each SIDE shall be limited to three (3) in limine requests, unless otherwise permitted by the Court. The in limine request and any response shall contain the authorities relied upon; each in limine request may be supported by a maximum of three (3) pages of argument and may be opposed by a maximum of three (3) pages of argument, and the side making the in limine request may add a maximum of one (1) additional page in reply in support of its request. If more than one party is supporting or opposing an in limine request, such support or opposition shall be combined in a single three (3) page submission (and, if the moving party, a single one (1) page reply), unless otherwise ordered by the Court. No separate briefing shall be submitted on in limine requests, unless otherwise permitted by the Court.

X. Discovery

Each party has completed discovery.

XI. Number of Jurors

There shall be eight jurors. The Court will conduct jury selection through the “struck juror” method, beginning with the Court reading voir dire to the jury panel in the courtroom, continuing by meeting with jurors individually in chambers or at sidebar and there addressing any challenges for cause, and concluding with peremptory strikes.

XII. Non-Jury Trial

[If the parties desire a detailed opinion from the Court posttrial, counsel should include a proposed posttrial briefing schedule, including page limits, in the draft pretrial order.]

Along with their initial briefs, each party shall provide proposed Findings of Fact, separately stated in numbered paragraphs, constituting a detailed listing of the relevant material facts the party believes it has proven, in a simple narrative form, along with citations to the record. The proposed Findings of Fact shall be limited to a maximum of ___ pages. No separate Conclusions of Law shall be filed.

XIII. Length of Trial

The trial will be timed. Unless otherwise ordered, time will be charged to a party for its opening statement, direct and redirect examinations of witnesses it calls, cross-examination of witnesses called by any other party, closing argument, its argument on any motions for judgment as a matter of law, and all sides’ argument on objections a party raises (outside the presence of the jury) to another party’s exhibits and demonstrative exhibits.

The Courtroom Deputy will keep a running total of trial time used by counsel. If any party uses all of its allotted trial time, the Court will terminate that party’s trial presentation.

Considering the Court’s procedures for counting time, and considering the nature and extent of the parties’ disputes, the parties request ___ hours for their trial presentation. [Indicate the number of hours the parties request for their trial presen-

tations. On days other than those involving jury selection, jury instructions, or deliberations, a typical day involves between 5 ½ and 6 ½ of trial time. In a typical bench trial, each day will involve between 6 and 7 hours of trial time. If the Court has previously set a maximum number of days that will be reserved for trial in this matter, the Court will not, absent good cause shown, allocate more hours for trial presentations than can be accommodated within the number of days reserved.]

XIV. Motions for Judgment as a Matter of Law

[The parties shall provide their position(s) as to how they will make motions for judgment as a matter of law, whether it be immediately at the appropriate point during trial or at a subsequent break, whether the jury should be in or out of the courtroom at the time such motions are made and/or argued, and whether such motions may be supplemented in writing.]

XV. Amendments of the Pleadings

[Indicate any amendments of the pleadings desired by any party, along with a statement whether the proposed amendment is objected to and, if objected to, the grounds for the objection.]

XVI. Additional Matters

[List any additional issues requiring resolution prior to trial, including whether the parties anticipate requesting that the courtroom be closed to the public for a portion of any specified witness' testimony.]

XVII. Settlement

[Provide a certification that the parties have engaged in a good faith effort to explore the resolution of the controversy by settlement, including a description of the overall extent of such efforts and identification of the date of the most recent substantive discussions regarding settlement.]

IT IS HEREBY ORDERED that this Final Pretrial Order shall control the subsequent course of the action, unless modified by the Court to prevent manifest injustice.

DATED: _____

UNITED STATES DISTRICT JUDGE

APPROVED AS TO FORM AND SUBSTANCE:

ATTORNEY FOR PLAINTIFF(S)

ATTORNEY FOR DEFENDANT(S)

Chapter 8

Trial

- 8.1 Procedural Issues 2
 - 8.1.1 Separate Trials 3
 - 8.1.1.1 Bifurcating Legal and Equitable Issues 4
 - 8.1.1.1.1 When to Bifurcate 4
 - 8.1.1.1.2 Use of an Advisory Jury 6
 - 8.1.1.2 Separate Proceeding on Willfulness 6
 - 8.1.1.3 Bifurcating Damages 7
 - 8.1.1.4 Bifurcating Different Patents 7
 - 8.1.1.5 Bifurcating Nonpatent Causes of Action 8
 - 8.1.1.6 Bifurcating to Aid Juror Comprehension 9
 - 8.1.2 Trial Logistics 9
 - 8.1.2.1 Time Limits 10
 - 8.1.2.1.1 Determining the Length of Trial 10
 - 8.1.2.1.2 Allocation of Trial Time 11
 - 8.1.2.1.2.1 Time Limits on Witness Examinations 11
 - 8.1.2.1.2.2 Time Limits on Opening and Closing Statements 12
 - 8.1.2.1.3 Modification of Time Limits 12
 - 8.1.2.2 Procedures for the Presentation of Evidence 13
 - 8.1.2.2.1 Trial Schedule 13
 - 8.1.2.2.2 Order of Trial Presentations 14
 - 8.1.2.2.2.1 Evidentiary and Witness Presentation 14
 - 8.1.2.2.2.2 Closing Statements 15
 - 8.1.2.2.2.3 Openness of Courtroom 15
 - 8.1.2.2.2.3.1 Exclusion of Witnesses 15
 - 8.1.2.2.2.3.2 Exclusion of Public 16
 - 8.1.2.2.3 Openness of Courtroom 15
 - 8.1.2.3 Procedures for Managing the Jury 16
 - 8.1.2.3.1 Jury Selection and Voir Dire 16
 - 8.1.2.3.2 Timing of Jury Instructions 17
 - 8.1.2.3.2.1 Jury Admonitions 18
 - 8.1.2.3.3 Juror Binders 19
 - 8.1.2.3.4 Jury Note-Taking 19
 - 8.1.2.3.5 Allowing Juror Questions 20
 - 8.1.2.3.6 Transition Statements by Counsel to the Jury 20
 - 8.1.2.3.7 Jury Education and Tutorials 21
 - 8.1.2.4 Special Masters, Court-Appointed Experts, or Technical Advisors 21
- 8.2 General Evidentiary Issues 24
 - 8.2.1 Witnesses 24
 - 8.2.1.1 Patent Law Experts 24
 - 8.2.1.2 Inventor and Other Technical Party Employee Testimony 25
 - 8.2.2 Exhibits 26
 - 8.2.3 Demonstratives 28
 - 8.2.4 Limits on Attorney Argument 28
- 8.3 Specific Substantive Issues 28
 - 8.3.1 Limitations on the Number of Asserted Claims 29
 - 8.3.2 Indirect Infringement 30
 - 8.3.3 Invalidity 31
 - 8.3.3.1 Presumption of Validity 31
 - 8.3.3.2 Obviousness 31
 - 8.3.4 Patent Damages 33
 - 8.3.4.1 Lost Profits 33
 - 8.3.4.2 Reasonable Royalty 34

8.3.4.2.1	Royalty Base	35
8.3.4.2.2	Royalty Rate	36
8.3.4.2.2.1	Rejection of General, Simplistic Apportionment Rules	38
8.3.4.2.2.2	Consumer Surveys and Conjoint Analysis	38
8.3.4.2.2.3	FRAND/Standard Essential Patents	39
8.3.4.2.2.4	Indirect Infringement	40
8.4	Motions for Judgment as a Matter of Law	40
8.5	Jury Deliberations	41
8.5.1	Schedule of Deliberations	41
8.5.2	Claim-Construction Considerations	42
8.5.3	Jury Access to Evidence	42
8.5.3.1	Exhibits and Demonstratives	42
8.5.3.2	Testimony	42
8.5.3.3	Juror Questions During Deliberations	43
8.5.4	Verdict Forms	43
8.5.4.1	General Verdict Forms	43
8.5.4.2	Special Verdict Forms and Special Interrogatories	43
8.6	Bench Trials	44

In previous chapters, we discussed approaches for managing patent cases during the various stages of pretrial litigation. While case management during the pretrial phase goes a long way in ensuring smooth proceedings during trial, patent trials present their own distinctive challenges.

In a patent case, the involvement of a lay jury, which typically lacks knowledge concerning the complex and highly technical issues in question, colors almost all aspects of trial. Inherent complexity and inappropriate argumentation can result in unsupportable or inconsistent findings of fact by a confused jury. An inordinate amount of time and resources after trial may be spent trying to unravel and remedy such findings. Thus trial, like all other phases of a patent case, benefits from early and close judicial management to assist the fact finder to evaluate the merits.

As the Federal Circuit has remarked, a court’s “discretion is at its broadest on matters of trial management.” *Mass. Inst. of Tech. v. Abacus Software*, 462 F.3d 1344, 1367 (Fed. Cir. 2006). This chapter reviews the procedural and substantive considerations that factor into the exercise of the court’s discretion and discusses approaches for structuring proceedings and narrowing issues to facilitate the jury’s and the court’s fact-finding role.

8.1 Procedural Issues

Before any trial can begin, the court must define the scope of trial and the ground rules governing its proceedings, including bifurcation and trial logistics. And when a jury is involved, the court should also establish procedures for assisting the jury’s comprehension of the technologies involved. These issues must be addressed to some degree in all civil trials, but are of particular import in the patent litigation context, where cases often involve numerous complex and technical claims and defenses.

This section discusses the advantages and disadvantages of particular approaches to these process issues. Specifically, we explore when to hold separate trials for the

different issues disputed in patent cases. We discuss under what circumstances particular trial schedules and organizations work best. We then consider what procedures a court can adopt to assist the jury in understanding a patent case's often highly technical trial presentations.

8.1.1 Separate Trials

The first question in any patent trial is whether all the issues involved should be resolved in a single proceeding. The trial court has broad discretion with regard to trial management. Federal Rule of Civil Procedure 42(b) provides:

[f]or convenience, to avoid prejudice, or to expedite and economize, the court may order a separate trial of one or more separate issues, claims, crossclaims, counterclaims, or third-party claims. When ordering a separate trial, the court must preserve any federal right to a jury trial.

Nonetheless, the court's discretion is not without limits. Even if multiple actions involving the same or similar issues, such as infringement of the same patent, have been consolidated for pretrial purposes, they nevertheless must be separately tried unless:

(1) any right to relief is asserted against the parties jointly, severally, or in the alternative with respect to or arising out of the same transaction, occurrence, or series of transactions or occurrences relating to the making, using, importing into the United States, offering for sale, or selling of the same accused product or process; and,

(2) questions of fact common to all defendants or counterclaim defendants will arise in the action.

§ 299; see §§ 2.2.2.1.1, 5.1.3.8. More generally, when deciding whether issues should be separately tried, trial courts must ensure that a litigant's constitutional right to a jury is preserved. "Maintenance of the jury as a fact-finding body is of such importance and occupies so firm a place in our history and jurisprudence that any seeming curtailment of the right to a jury trial should be scrutinized with the utmost care." *Dimick v. Schiedt*, 293 U.S. 474, 486 (1935).

It is generally more efficient to have one trial and one appeal. See *Johns Hopkins Univ. v. CellPro*, 160 F.R.D. 30, 35 (D. Del. 1995). Thus, bifurcation in patent cases is the exception, not the rule, and appropriate only if it will promote judicial economy and not be inconvenient or prejudicial to the parties. See *F & G Scrolling Mouse L.L.C. v. IBM Corp.*, 190 F.R.D. 385 (M.D.N.C. 1999) (burden on moving party to show bifurcation will (1) promote greater convenience to parties, witnesses, jurors, and the court, (2) be conducive to expedition and economy, and (3) not result in undue prejudice to any party); *Spectra-Physics Lasers, Inc. v. Uniphase Corp.*, 144 F.R.D. 99, 101 (N.D. Cal. 1992) (denying motion to bifurcate trial into separate liability and damages phases where defendant failed to meet its burden).

Patent cases are often complex, however, sometimes involving different technologies, nonpatent claims with overlapping facts, and various legal and equitable claims and defenses. Whether all these issues should be resolved in a single trial de-

depends on the facts and circumstances of the particular case. Factors to be considered when deciding whether to bifurcate include: whether the issues, and the evidence required for each issue, are significantly different; whether they are triable by jury or the court; whether discovery has been directed to a single trial of all issues; whether a party would be prejudiced by a single or separate trials; and whether a single trial would create the potential for jury confusion. *McDaniel v. Anheuser-Busch, Inc.*, 987 F.2d 298, 305 n.22 (5th Cir. 1993); *Angelo v. Armstrong World Indus., Inc.*, 11 F.3d 957, 964 (10th Cir. 1993); *Hirst v. Gertzen*, 676 F.2d 1252, 1261 (9th Cir. 1982); *Kimberly-Clark Corp. v. James River Corp.*, 131 F.R.D. 607, 608–09 (N.D. Ga. 1989).

Ultimately, considerations regarding the manageability and comprehensibility (particularly for jurors) of the various issues presented in the case should govern the decision to bifurcate and hold separate trials. From a case-management standpoint, bifurcation can assist the court in segregating from juror consideration evidence that may be integral for one issue, but irrelevant and prejudicial for another issue in the case. Bifurcation can also assist jurors by focusing jurors' attention on one issue at a time, helping to avoid confusion that can result from overwhelming jurors with multiple complex issues as once. At the same time, there are efficiencies that result from resolving all issues in one proceeding that should not be disregarded when deciding whether to bifurcate or even trifurcate patent cases.

8.1.1.1 Bifurcating Legal and Equitable Issues

Many of the defenses to a patent infringement action are equitable in nature. In addition to noninfringement and invalidity, many defendants assert inequitable conduct, patent misuse, laches, or equitable estoppel that would render an asserted patent unenforceable. There are also affirmative patent issues, such as joint inventorship, that are equitable in nature. While the facts underlying the merits of infringement and invalidity issues and defenses are within the province of a jury, equitable issues and defenses are exclusively within the court's purview.

8.1.1.1.1 When to Bifurcate

Because legal and equitable issues are decided by different fact finders, it is common and appropriate to hold separate jury and bench trials on the different issues. Separate trials are particularly appropriate where the equitable issues involve facts that are irrelevant or only marginally relevant to the liability issues to be decided by the jury, or which may prejudice a party's case on infringement or validity. For example, allegations of inventor misconduct before the USPTO relevant to an inequitable conduct defense, while irrelevant to infringement, may influence a jury's decision on that issue by suggesting that the inventor is untrustworthy. Separating the equitable issues for the court will avoid jury confusion and ensure that the jury's decision is based on proper and relevant evidence.

Moreover, a separate and early trial on the equitable defenses can sometimes promote resolution of the case. See *Agfa Corp. v. Creo Prods. Inc.*, 451 F.3d 1366, 1371–75 (Fed. Cir. 2006) (affirming trial court's discretion to conduct a bench trial on the equitable issue of unenforceability before infringement or validity are tried to

a jury (citing *Gardco Mfg., Inc. v. Herst Lighting Co.*, 820 F.2d 1209, 1213 (Fed. Cir. 1987)). Where the alleged infringer has a strong, equitable defense, a trial on those issues may lead to an early unenforceability finding, obviating the more expensive and technically involved jury trial phase on infringement and validity.

While holding two separate proceedings can be more burdensome, there are procedures for increasing the efficiency of multiple trials. Jury trials and bench trials can be conducted in parallel to reduce the burden on witnesses who may have relevant testimony for both phases. By trying the legal issues to the jury in the morning sessions, and then conducting the bench trial in the afternoon, the court can coordinate the availability of witnesses and conserve both judicial and party resources.

Bifurcating legal and equitable claims can, however, implicate Seventh Amendment concerns if the bench trial is held prior to a jury determination of legal claims. In this circumstance, care must be taken not to impinge on a party's right to a full jury trial on its legal claims when trying equitable claims separately. *Beacon Theatres, Inc. v. Westover*, 359 U.S. 500, 508 (1959). Facts relevant to a party's legal claims must be decided by a jury. To the extent there is significant factual overlap between the legal and equitable issues, it may be improper for the court to decide the equitable issues before a jury determines the legal issues. For example, the Federal Circuit found it improper to hold a bench trial on the equitable issue of correction of inventorship before the jury could decide the state-law fraud issue of whether the patentee misrepresented being the sole inventor of the patent to the USPTO and third parties. *See Shum v. Intel*, 499 F.3d 1272, 1277–79 (Fed. Cir. 2007). The relationship between the equitable and legal issues is the determinative factor: whether there is commonality between the factual disputes underlying the equitable and legal issues such that determination of the equitable issue by the court effectively denies a party the right to a jury trial on the legal issues. Thus, bench trials on equitable issues can be held before a jury trial on legal issues without violating the Seventh Amendment if resolution of the respective questions turns on different factual foundations. *See generally Ethicon v. U.S. Surgical Corp.*, 135 F.3d 1456 (Fed. Cir. 1998) (upholding district court's finding of improper inventorship and dismissal of infringement issue because infringement question did not share common factual foundation with the inventorship issue); *Paragon Podiatry Lab., Inc. v. KLM Labs., Inc.*, 984 F.2d 1182, 1190 (Fed. Cir. 1993) (“The defense of inequitable conduct in a patent suit, being entirely equitable in nature, is not an issue for a jury to decide A patentee has no right to a jury trial respecting the factual element of culpable intent as part of the defense of inequitable conduct.”).

Efficiency is another consideration in deciding whether to bifurcate legal and equitable issues. It may be more efficient to present all the evidence in one proceeding. For example, evidence of patent misuse, an equitable issue for determination by the judge, is often the same evidence used to support antitrust allegations, where it is used to determine factual issues by the jury. Courts should consider whether evidence that otherwise should be limited to a court hearing on equitable issues is also relevant to issues that the jury will determine. While not dispositive of the question of bifurcation, it is appropriate to consider whether efficiencies can be achieved by having the same evidence presented simultaneously to the jury and the court. Courts

should continue to consider and weigh the potential benefits of efficiency against the potential for prejudicial misuse of evidence by the jury.

8.1.1.1.2 Use of an Advisory Jury

Although reserved for the court, equitable issues need not be tried separately. All issues can go to the jury by consent of the parties. Fed. R. Civ. P. 39(c). Even without consent, the court may try the equitable issues with an advisory jury. *Id.* The jury's verdict on the equitable issues is merely advisory, and a court may consider it but is not bound by the decision. The advantage of an advisory jury is that it enables all issues to be presented within one proceeding; a major disadvantage is that it risks contaminating the jury's consideration of the legal issues (for example, invalidity) with evidence relevant only to the equitable claim (for example, inequitable conduct). Moreover, a jury's fact-finding can constrain the court's determination on equitable issues, and courts need to be conscientious not to disregard findings of fact—explicit or implicit—that implicate legal claims. *See, e.g., Kinetic Concepts, Inc. v. Smith & Nephew, Inc.*, 688 F.3d 1342 (Fed. Cir. 2012) (implied jury factual findings within verdict of obviousness).

In light of these considerations, it is often preferred to have equitable issues, such as inequitable conduct, tried separately to the court following the jury's consideration of the legal issues. A separate proceeding after the jury's fact-finding provides the court the benefit of the jury's factual determinations (avoiding any Seventh Amendment issues), while eliminating the risk of juror confusion or prejudicial misuse of evidence relevant only to the equitable issues. Only the evidence relevant to the equitable issues and not presented to the jury need be presented during the separate court proceeding. As a result, a separate court trial on inequitable conduct, for instance, typically only requires an additional one or two days. The additional time needed for a separate court trial on inequitable conduct is often counterbalanced by not having to present this additional evidence to the jury or spend time during the jury phase discussing possible limiting instructions regarding evidence relevant only to equitable issues.

8.1.1.2 Separate Proceeding on Willfulness

The Supreme Court in *Halo Electronics, Inc. v. Pulse Electronics, Inc.*, No. 14-1513 (Supreme Court June 3, 2016), removed the ultimate determination of enhanced damages from the jury, leaving the issue exclusively to the court to decide. *See* § 7.3.4.5. The Federal Circuit has since held that the factual components of the willfulness question should be resolved by the jury. *See WBIP, LLC v. Kohler Co.*, ___ F.3d ___ (Fed. Cir. July 19, 2016). As with other issues for determination by the court, proof of factors bearing on the award of enhanced damages may include evidence not relevant to the issues to be decided by the jury, such as evidence relating to the subjective intent of the alleged infringer, which may be prejudicial to a party if admitted during the jury trial. Using the analysis described above (§ 8.1.1.1.1), the court should determine whether this prejudice justifies bifurcation of the enhanced damages factors in view of the evidence the parties propose to present in a particular

case. If a court does bifurcate these issues, it may delay determination of this issue until after resolution of an appeal of the liability determination. *Robert Bosch, LLC v. Pylon Mfg. Corp.*, 719 F.3d 1305 (Fed. Cir. 2013) (en banc).

8.1.1.3 Bifurcating Damages

Liability and damages issues frequently are susceptible to bifurcation. *F & G Scrolling Mouse L.L.C v. IBM Corp.*, 190 F.R.D. 385, 388 (M.D.N.C. 1999). The determination of damages presents its own set of issues separate and apart from the complexity of the liability aspects of most patent cases. Proof of lost profits or a reasonable royalty can involve voluminous data and complicated financial analysis by economic experts. This evidence can be difficult to understand and may have little relationship to patent liability issues. Separating these issues can sometimes reduce the complexity of the case while increasing the jury's ability to understand the evidence presented.

Bifurcation of damages can also expedite a trial if the alleged infringer prevails on liability. Even if the patentee prevails on liability, there is a chance that the parties will settle the remainder of the case without the need for a damages phase. The likelihood of needing to try damages may be further diminished if the court enters judgment following the liability trial, thereby allowing an appeal of the liability issues before damages are taken up. *See Robert Bosch, LLC v. Pylon Mfg. Corp.*, 719 F.3d 1305 (Fed. Cir. 2013) (en banc).

Often, however, the patentee will seek to pursue adjudication of damages following the liability stage, which results in significant duplication of effort in staging a second trial. Furthermore, patentees have a legitimate argument that bifurcating damages can skew the verdict against them, since the jury knows it can go home earlier if it rules for the accused infringer on liability. In practice, most courts decline requests to bifurcate damages.

In some cases, resolving the damages issue likely would lead to a settlement, eliminating the need to try the lengthy panoply of liability issues. This has led some commentators and parties to suggest employing "reverse bifurcation," in which damages are bifurcated from liability and tried first. *See, e.g., In re Innovatio IP Ventures, LLC Patent Litig.*, 956 F. Supp. 2d 925, 929 (N.D. Ill. 2013); *STC UNM v. Intel Corp.*, 2011 U.S. Dist. LEXIS 15439, 2011 WL 7562686 (D.N.M. Dec. 22, 2011); J. Rantanen, *Reverse Bifurcation Practice*, <http://www.patentlyo.com/patent/2011/07/reverse-bifurcation-1.html> (July 31, 2011).

8.1.1.4 Bifurcating Different Patents

Patent cases often involve counterclaims for patent infringement. While a plaintiff may assert one set of patents, a defendant may counterclaim for infringement of its own patents. Often the technologies between the plaintiff's asserted patents and the defendant's asserted patents are the same, such that trial on both sets of infringement claims would involve the same expert witnesses and the same fact witnesses. In those cases, it may be more efficient to have both the patent infringement

claims and counterclaims go forward in one trial. See *Hilleby v. FMC Corp.*, No. C-91-0568 FMS (CW), 1992 U.S. Dist. LEXIS 20835, 1992 WL 455436, at *3 (N.D. Cal. May 13, 1992).

Where the patents asserted in the counterclaim implicate different technology, different facts, different defenses, and different witnesses, trying all these issues together in one proceeding may be inappropriate. Sorting through different technologies and the different related claims and defenses can be unmanageable for both the court and the jury. In such cases, the court should consider bifurcating the plaintiff's patent action from the defendant's patent counterclaims and holding separate trials.

Typically, the plaintiff's case should proceed first, with trial on defendant's patents following. The second trial should proceed immediately after the first to avoid any unfair advantage that may result from resolving one set of patent infringement allegations before the other.

8.1.1.5 Bifurcating Nonpatent Causes of Action

In addition to patent causes of action, parties often assert related causes of action, such as antitrust, contract, and trade secret. Separate trials for the nonpatent causes can help streamline the case and make issues more comprehensible. Whether bifurcation is appropriate depends on the interrelationships of the causes of action asserted and the specifics of the case.

Antitrust counterclaims in patent infringement actions often are bifurcated. While equitable defenses to patent infringement, such as patent misuse, can implicate antitrust issues, antitrust claims often involve a different body of law and a different factual inquiry than patent infringement or invalidity. The Federal Circuit has recognized that bifurcating antitrust claims is a common and accepted practice. See *In re Innotron Diagnostics*, 800 F.2d 1077, 1086 (Fed. Cir. 1986). When bifurcating antitrust claims, it is usually advisable to try the patent allegations first. The outcome of the antitrust trial will often depend on the resolution of the patent cause of action. Moreover, parties often assert antitrust claims in patent cases for the purpose of gaining leverage in the litigation. Resolution of the patent case will often lead the parties to settle the antitrust suit, eliminating the need for the court to expend time and resources considering claims that are of collateral or secondary importance.

Nonpatent causes of action based on contract and trade-secret law are sometimes less amenable to bifurcation. When patents are the subject of a licensing agreement or some other contract, resolution of the patent cause of action is often dispositive or at least relevant to the contract cause of action. And where a trade secret claim involves arguments that either one of the parties misappropriated closely related technology, it will usually make sense to try the causes of action together. However, if the collateral cause of action is that the patent itself resulted from a theft of secrets, it may be more sensible to try the trade-secret-misappropriation cause of action first.

8.1.1.6 Bifurcating to Aid Juror Comprehension

As discussed in §§ 8.1.1.1–8.1.1.5, the decision to bifurcate any particular issue should balance the interests of the parties, the efficiencies in holding one proceeding, the court’s ability to manage the case, and the practical ability of the jury to comprehend the complex issues in the case. Not only is the number of patent cases increasing in recent years, but so is the number of defendants named as alleged infringers in each case. As this trend continues, concerns over the jury’s ability to keep track of the patent technology and the technology of each of the many accused products will weigh more heavily in the bifurcation calculus. Naturally, the more complex the case, the more bifurcation will become a necessity to ensure manageability and juror comprehension. In very complex cases (involving multiple defendants and multiple patents), courts are now considering bifurcating not only the issues discussed in §§ 8.1.1.1–8.1.1.5, but also the issue of infringement and validity, as well as holding separate trials for separate defendants. Note that the AIA now restricts the defendants who can be joined in a single infringement case. *See* § 299; § 2.2.2.1.1.

In a one-patent, one-defendant case, the overall balance of interests usually disfavors bifurcating the jury’s determination of infringement from its determination of patent validity. When multiple defendants and multiple patents are involved, however, a jury will be asked to evaluate the various patented inventions against numerous accused products. That undertaking, combined with the introduction of numerous prior art references relevant to the validity inquiry, can be overwhelming, particularly when the asserted patents implicate complicated technology. In such cases, any economic benefit to having only one proceeding is significantly outweighed by the likelihood of juror confusion. In many complex cases, courts are now considering trying infringement separate from validity. The court can maintain some degree of consistency and efficiency by trying the issues to the same jury while allowing the jury to focus on one issue at a time through separate proceedings. With the same jury impaneled, the parties need not duplicate presentation of evidence relevant to both infringement and validity. In addition, this process may encourage settlement, as it affords the parties an opportunity to evaluate their case at each stage.

Similarly, in cases in which a plaintiff has named multiple defendants, courts may elect to hold separate trials, especially on infringement issues for individual defendants or separate groups of defendants with similar infringement issues. This will assist the jury in keeping track of the various accused products and technologies implicated by the lawsuit. Moreover, codefendants can disagree on trial strategies, and separate proceedings will enable each defendant to control its defense.

While bifurcating or trifurcating cases into more manageable units assists in juror comprehension, the associated costs to holding separate trials make bifurcation a practice best reserved for the most complex cases.

8.1.2 Trial Logistics

Whatever the scope of the trial, it is the court’s responsibility to set and enforce the guidelines that govern its proceedings. Effective management of patent trials includes establishing reasonable time limits, maintaining a daily trial schedule, and

outlining the order of the parties' presentations. With an established protocol, the parties are better able to structure and streamline their presentations to fit the court's schedule, resulting in a more understandable and efficient dispute resolution process.

8.1.2.1 Time Limits

A trial court's inherent power to control cases includes the broad authority to impose reasonable time limits during trial to focus the parties' presentation of evidence and prevent undue delay, waste of time, or needless presentation of cumulative evidence. Fed. R. Civ. P. 16(c)(15); *see also* *Applera Corp. v. MJ Research Inc.*, 389 F. Supp. 2d 344, 348 (D. Conn. 2005); *Motorola v. Interdigital Tech. Corp.*, 930 F. Supp. 952, 983 (D. Del. 1990) ("The Court's inherent power to control cases before it includes the power to set time limits for a trial."). Time limits have been recognized as a trial technique that enhances the quality of justice and improves the administrative aspects of any civil trial. *Amgen, Inc. v. Hoechst Marion Roussel, Inc.*, 339 F. Supp. 2d 202, 298 (D. Mass. 2004) (citing *The Vanishing Trial*, Discussion at the ABA Section on Litigation Symposium (Dec. 12–14, 2003)). They force the parties to evaluate what is and is not important to their case. Time limits are particularly appropriate in patent cases, where the issues are complex, and an unduly long trial would unnecessarily burden jurors and the court. *Applera*, 389 F. Supp. 2d at 348.

8.1.2.1.1 Determining the Length of Trial

What is a reasonable time for trial depends on the particulars of a case. The number of patents at issue, the complexity of the technology, the nature and number of any associated nonpatent claims, and whether issues are being bifurcated should all be taken into consideration when determining the length of trial.

To account for all these factors, a court's limits on the length of trial should be set after an informed analysis based on a review of the parties' proposed witness lists and proffered testimony, as well as their estimates of trial time. *See Duquesne Light Co. v. Westinghouse Elec. Corp.*, 66 F.3d 604, 610 (3d Cir. 1995). Time limits that are reasonable are (1) established in consultation with the parties; (2) allocated evenhandedly; (3) allotted to whatever evidence the parties deem appropriate; and (4) applied flexibly. *Id.*

Whatever the specifics of the case, a limit on the total amount of time for trial is advisable in almost every patent case. An open-ended case schedule quickly can become unmanageable in the face of so many complex issues, and imposes an unnecessary and unreasonable burden on the jury impaneled to hear the case. Therefore, the court should adopt an absolute limit on the length of trial based on input from the parties and the court's own evaluation of the case. Experience has shown that most patent cases can be fully tried within two weeks, allocating approximately twenty hours to each side, beginning with opening statements and continuing through closing arguments. (Procedures conducted by the court, mainly voir dire and instructions, typically are not clocked.)

8.1.2.1.2 Allocation of Trial Time

In general, trial time should be split evenly between the parties. The nature of patent cases is such that the burden of presenting evidence falls roughly equally on the parties. The presumed equal allocation can be adjusted for any demonstrable difference in the complexity of issues. Any time spent questioning witnesses, either on direct or cross-examination, should be counted against the questioning party, as would time spent reading that party's designated deposition transcripts into the record. *Duquesne Light Co.*, 66 F.3d at 610 (expressing concern over the district court's "puzzling" calculation of time by attributing the defendant's cross-examination of plaintiff's witnesses against plaintiff's trial time); *Applera*, 389 F. Supp. 2d at 347–48.

The key is to provide some temporal framework to motivate the parties to use trial time efficiently. How structured of a framework is required depends on the specifics of the case. In some cases, it is enough to inform the parties of their total time for trial and leave it to their discretion to determine how to utilize their time. In other cases, it may be appropriate for the court to allocate time for each phase of trial, placing time limits on opening and closing statements and each witness examination.

8.1.2.1.2.1 Time Limits on Witness Examinations

A highly managed approach with set time limits for each witness examination should be reserved for the most complex cases involving multiple patents and multiple different claims and defenses. These cases are often lengthy and have the greatest risk of jury confusion. Extending trial beyond the initial estimate can pose an undue hardship on jurors. Limiting the time for each phase of trial helps to regulate the parties' use of time, ensuring that they will stay within the time allotted for trial. Setting and requiring the parties to meet interim time limits also compels them to assess their case and the importance of each witness for each phase of the trial, which leads to clearer and more targeted presentations and examinations for the fact finder.

The difficulty with this approach, however, is that trial is a fluid process. Rigid time limits restrict the parties' ability to react to events and revelations that occur during the trial. During trial, the parties often drop witnesses or make changes to their examinations. It is harder to adapt to these changes in a case that has already divided the trial time for different witnesses. Indeed, the imposition of time limits for individual witnesses often invites additional disputes and requests during trial for adjustment of time allotments. As a result, a tool that should help a trial proceed more smoothly will, in fact, stymie the orderly progression of trial.

In almost all cases, it is sufficient to allow the parties to determine how much time to spend examining particular witnesses from their general time allotment. Permitting flexibility in witness examinations allows the parties to adjust their presentations to highlight witnesses that prove more critical and to follow up on testimony elicited during trial. Counsel in patent cases are often litigators with enough experience to manage their time without the need for limits on individual witness examinations. Thus, this type of high-level management is far more likely to promote an efficient trial and avoid ongoing requests for time adjustments.

8.1.2.1.2.2 Time Limits on Opening and Closing Statements

Time limits on opening and closing statements are more common and more feasible than trying to predict how much time is necessary and appropriate for each witness. Many courts have established time limits for opening and closing statements.

Typical time limits are less applicable in the patent context, however. Due to the complexity and the number of issues involved, opening and closing statements in a patent case usually require more time than those in a typical civil case. It is not unusual for the parties in a patent case to spend from one to two hours on an opening or closing statement. More commonly, opening arguments in patent cases fall within the thirty- to forty-five-minute range and closings from forty to sixty minutes (including rebuttal).

Thus, the ten- to thirty-minute time limit sometimes imposed in civil cases is generally not appropriate in a patent trial. The amount of time needed for useful opening and closing statements in patent cases approaches the practical time limit dictated by a jury's attention span. Thus, a fair and appropriate time limit on opening and closing statements is often superfluous, as parties rarely extend statements beyond that.

8.1.2.1.3 Modification of Time Limits

Whatever approach is taken, time limits should not to be applied so rigidly as to "sacrifice justice in the name of efficiency." *Navellier v. Sletten*, 262 F.3d 923, 941 (9th Cir. 2001). Strict adherence to time limits that prejudice a party's case can lead to new trial motions and grounds for appeal.

To ensure that the time limits imposed are reasonable, the court should monitor how much time is charged to each party and provide periodic updates to the parties. Giving periodic updates allows the parties to reassess case strategy and their allocation of time, if necessary.

It is advisable to have court staff act as the official timekeepers to avoid disputes or uncertainty that can result if the parties are left to the task. Court oversight of the trial clock enables the court to evaluate the progress of the case and ensure that the parties are on schedule. Based on the continued reassessment of the case, the court can determine if a party's request for additional time is warranted. Courts should exercise some flexibility in modifying time limits where the parties have been conscientious and expeditious in their use of time. Where, however, the lack of time available at the end of the case is the consequence of a party's mismanagement, it is not an abuse of discretion to refuse additional time. *See, e.g., Gen. Signal Corp. v. MCI Telecomms. Corp.*, 66 F.3d 1500, 1508–09 (9th Cir. 1995).

While the court need not grant additional time, it should not reduce a party's time without good cause. "[A]n allocation of trial time relied upon by the parties should not be taken away easily and without warning." *Duquesne*, 66 F.3d at 610. The parties plan trial strategy based on their time allotment. Action taken to reduce the allotment during trial leaves little opportunity to reassess trial plans. Therefore,

modifications of time limits that reduce time allotment should rarely be made, and only when a party is abusing trial time. Even then, a party should be given clear warning and indication of the consequences of its trial behavior before action is taken.

As time estimates are subject to modification, the jury should not be informed of specific time limits. It is usually advisable to inform the jurors of how long the trial is expected to last to determine whether they will be able to serve and to allow them to make necessary arrangements. See Ninth Circuit Jury Trial Improvement Committee, *Second Interim Report: Recommendations and Suggested Best Practices, Recommendation II* (October 2006). Discussions regarding specific interim time limits, however, are not information jurors need to perform their duty.

While it can be a tactic used to motivate the parties to operate within time limits, making the jury conscious of time can draw attention away from the merits of the presentation. Clocks can become a distraction and interfere with the jury's role as a neutral fact finder. Furthermore, the jury may become biased against a party that uses or requests more time. Accordingly, discussions regarding time should also be conducted outside the presence of the jury.

8.1.2.2 Procedures for the Presentation of Evidence

In addition to time limits, the court must also determine how the presentation of evidence is going to proceed during trial. The court needs to set a schedule that will facilitate the timely completion of trial. It also needs to establish the order in which the parties will use their time to present the various issues. The court should consider what will assist the jury in understanding the evidence to ensure that presentations and arguments are helpful.

8.1.2.2.1 Trial Schedule

The trial schedule adopted by the court will affect how long trial will last, and should be taken into consideration when setting time limits for trial. The trial schedule should also take into consideration the jury's attention span. Many factors go into determining an appropriate trial schedule: the potential burden on the jury, the court's availability, witness availability, holidays, and the issues being tried.

It may seem most efficient to complete trial by holding all-day proceedings five days a week. The court's obligation to other matters, however, may make it difficult to accommodate such a demanding schedule. Furthermore, many other practical considerations may make a full-time schedule infeasible, and in some cases less efficient.

Later in this chapter, we discuss the types of evidentiary issues that may arise during a patent trial. These issues must be resolved outside the presence of the jury. A full-day trial schedule leaves little time available for the court to consider disputes that arise during the course of trial. As a result, with full-day schedules, the jury may have to be kept waiting while the court resolves evidentiary or legal disputes. A half-day schedule allows the court to consider legal issues in the afternoon without wasting juror time. A court can also use the afternoon to try equitable issues without the

jury. Having the jury and bench trials proceed in parallel can help conserve resources as equitable issues often involve overlapping facts and witnesses. The advantages and disadvantages of holding parallel proceedings versus a separate bench trial following the jury trial are discussed more fully in the section on bifurcation. *See* § 8.1.1.1.

There are several additional benefits to adopting a half-day schedule that increase both the overall efficiency and quality of proceedings. The real advantage of a half-day schedule is that it allows jurors to arrange their schedules so that they can serve on the jury and still attend to their jobs or family responsibilities, reducing the hardship that would otherwise result from lengthy trials. The attention of the jury also wanes during long trial days. A half-day schedule also gives the parties more time to make their disclosures and prepare their presentations. In an abundance of caution, parties are often overinclusive in their presentations. Having more time to refine their case can eliminate a lot of needless evidence and corresponding disputes, increasing the overall efficiency of proceedings. *See* Ninth Circuit Jury Trial Improvement Committee, *Second Interim Report: Recommendations and Suggested Best Practices, Recommendation III*. Judges report that they accomplish as much, if not more, in a compressed scheduled day as in a regularly scheduled trial day, and that attorneys are usually better prepared.

Whether court is in session for four or five days a week, the goal of a trial schedule is to balance efficiency with quality. Holding full-day proceedings can certainly help to complete the trial faster. Such a rigorous schedule is best suited for shorter trials. Full-day schedules, however, can become overly demanding and burdensome for longer trials. In practice, it is rare for a typical patent trial to last for more than two weeks, particularly in light of the time limits that are becoming more common. Even for a trial that lasts two weeks or less, it is often advisable to hold at least one or two half-days during the trial week so that the court and the parties have built-in time to address evidentiary and trial logistics issues outside the presence of the jury.

8.1.2.2.2 Order of Trial Presentations

Once the trial time and schedule are set, the court should establish guidelines on how the time will be used. The court has discretion to control the order in which the parties will present proof. In typical cases, the plaintiffs go first because they bear the burden of proof. In patent cases, however, the burden of proof is shared by the parties. While plaintiffs bear the burden of proof on infringement, for example, defendants bear the burden of proof on invalidity. Therefore, the order of trial presentation and closing statements should take into account the various issues being tried.

8.1.2.2.2.1 Evidentiary and Witness Presentation

The parties' presentations should begin with the patentee's case-in-chief. As some cases are declaratory judgment actions, the patentee may not always be the plaintiff in the action. It nonetheless makes sense to have the patent owner's infringement case presented first as it is the rights conferred to a patentee that form the basis of all patent suits. The patentee must present all of its evidence on matters on

which it bears the burden of proof in its case-in-chief, including evidence of infringement and any other additional nonpatent claims.

At the close of the patentee's case, the alleged infringer will put on its case. In addition to responding to the patentee's evidence on infringement and willfulness, the alleged infringer must also present evidence on the claims on which it bears the burden of proof, such as invalidity and inequitable conduct (if tried together). Where infringement is not disputed, the defendant should usually proceed first on its invalidity defenses.

After the alleged infringer rests its case, the patentee should be allowed to present evidence restricted to responding to the alleged infringer's affirmative case (i.e., invalidity and/or inequitable conduct).

8.1.2.2.2 Closing Statements

Closing arguments should be structured similarly to the order of trial presentation. It is customary for the party with the burden of proof to open and close the arguments. *See, e.g., Moylan v. Meadow Club, Inc.*, 979 F.2d 1246, 1251 (7th Cir. 1992). With the burden of proof shifting for different claims, patent cases usually require four closing statements.

Again, the patentee usually begins, summarizing the evidence presented on its affirmative claims of infringement and damages, along with any other nonpatent causes of action. The alleged infringer then presents its closing remarks, summarizing its response to the patentee's claims and presenting its arguments on invalidity. The patentee then rebuts on infringement and damages and responds on invalidity. In some courts, the alleged infringer is allowed a final statement, restricted to rebuttal on invalidity.

8.1.2.2.3 Openness of Courtroom

8.1.2.2.3.1 Exclusion of Witnesses

The court's power to control and shape trial includes the power to sequester witnesses before, during, and after their testimony. *Geders v. United States*, 425 U.S. 80, 87 (1976). At the request of a party, the court must exclude witnesses so that they cannot hear the testimony of other witnesses. Fed. R. Evid. 615. The purpose is to prevent witnesses who have yet to testify from tailoring their testimony to that of earlier witnesses, and to increase the likelihood that testimony will be based on a witness's own recollection. *Id.*; Advisory Committee Notes.

The Federal Rules of Evidence, however, exempt a party or party representative from exclusion. *Id.* Therefore, a witness who has been designated as a company's corporate representative at trial is not excludable. The court should have the parties designate corporate representatives before the start of trial so that any issues regarding the designee's possible role as a witness can be resolved prior to trial.

The Federal Rules of Evidence also provide that a person whose presence is shown to be essential to the presentation of the party's cause should not be excluded. *Id.* This exception is most often applied to expert witnesses, but a showing that the expert's presence is essential to the case is still required. *See Malek v. Fed. Ins. Co.*,

994 F.2d 49, 53–54 (2d Cir. 1993); *Morvant v. Constr. Aggregates Corp.*, 570 F.2d 626, 629–30 (6th Cir. 1978). To avoid disputes, the court should encourage the parties to reach an agreement as to whether expert witnesses can remain in the courtroom during testimony of other witnesses.

8.1.2.2.3.2 Exclusion of Public

Separate from the issue of witness exclusion is the issue of whether the public will be excluded from the courtroom during trial. Patent cases often require presentation of confidential and proprietary technical information of a company, sometimes including third-parties' information. Protective orders governing the use of confidential competitive information are in place in almost all patent cases. Before trial begins, the court should decide what protective orders are necessary to protect trade-secret evidence introduced at trial.

While the public has a limited interest in information produced by parties during discovery, it has a strong right of access to information and documents introduced at trial. See *In re Adobe Sys., Inc. Sec. Litig.*, 141 F.R.D. 155, 165 (N.D. Cal. 1992). In general, trials should remain open and accessible to the public.

A courtroom should not be closed simply because a company's proprietary technology is involved. The public should be excluded only where there is a showing of a compelling interest in maintaining the confidentiality of documents or revelation of proprietary information through testimony. To the extent confidential documents or information are extensively and genuinely part of the case, they should be part of the public record. *Id.* at 161. The court should, however, protect against the entry of confidential information into the trial record for the sole purpose of damaging an opponent's business.

In contrast to some other areas of law in which secrecy is sought, the kind of information that the parties may want to protect in patent litigation is much more likely to be legitimate technical data that should be protected. If the court makes clear that it will grant sealing requests only when the requesting party has made an effort to "cluster" the offered evidence (so that the courtroom has to be cleared a minimum number of times), the problem becomes self-enforcing and inappropriate closure is avoided.

8.1.2.3 Procedures for Managing the Jury

While the court's decisions regarding trial logistics should always take into consideration the role of the jury, there are specific procedural mechanisms by which the court can directly address the issues of ensuring jury comprehension and guiding the conduct of the jury.

8.1.2.3.1 Jury Selection and Voir Dire

Like any other civil trial, patent jury trials are governed by the Federal Rules of Civil Procedure, which require that a jury be impaneled with a minimum of six and a maximum of twelve jurors. See Fed. R. Civ. P. 48. The decision as to how many ju-

rors will be impaneled should be finalized prior to the first day of trial and the start of the jury selection process.

As patent trials can take longer than other civil trials and are often more complex, it may prove difficult to find jurors able to commit the necessary time and attention. Such considerations weigh against impaneling a twelve-member jury. On the other hand, it is advisable to impanel more than the minimum six jurors to ensure a verdict can be taken if one or two jurors become unable to serve during trial.

The voir dire process in a patent trial is largely similar to that in other civil cases. However, given the specialized nature of the case, it is appropriate to question prospective jurors on their experience with the technology underlying the patents, experience with the patent system, and their feelings regarding patent protection.

Because both parties are likely to be interested in eliciting such information, the voir dire process can be streamlined by having the prospective jurors complete questionnaires ahead of time. The court should encourage the parties to settle on a juror questionnaire covering the information both sides are interested in eliciting before the start of trial. The parties and the court can determine whether any jurors should be excused for cause based on the responses to the juror questionnaire.

Thereafter, the court should explain the voir dire process to the prospective jurors, and allow each side a reasonable amount of time to conduct focused voir dire.

8.1.2.3.2 Timing of Jury Instructions

In the previous chapter, we discussed the process of preparing jury instructions for patent trials. Jury instructions are designed to explain the trial process to the jury and educate jurors on the law governing the issues they will be deciding. The parties have a right to have the jury instructed on the general law applicable to the case. See *Williams v. Jader Fuel Co., Inc.*, 944 F.2d 1388, 1402 (7th Cir. 1992); *H.H. Robertson Co., Cupples Prods. Div. v. V.S. DiCarlo Gen. Contractors, Inc.*, 950 F.2d 572, 578 (8th Cir. 1991). Indeed, the court has an independent duty to instruct the jury. *Belotte v. Zayre Corp.*, 531 F.2d 1100, 1102 n.1 (1st Cir. 1976).

Jury instructions must be set before closing arguments begin. Fed. R. Civ. P. 51(b). The court must allow the parties to object to instructions before the jury is instructed and before closing arguments. *Id.* Indeed, a party must object to an instruction before it can later claim an instruction was given in error. *Id.* In the past, this general rule was applied to jury instructions pertaining to the court's claim constructions. See, e.g., *Serio-US Indus., Inc. v. Plastic Recovery Techs. Corp.*, 459 F.3d 1311, 1317 (Fed. Cir. 2006) (holding that appellant failed to timely object to claim-construction jury instruction); *NTP, Inc. v. Research in Motion, Ltd.*, 418 F.3d 1282, 1312 (Fed. Cir. 2005) (recognizing defendant made a timely objection to claim-construction jury instruction) (citing *Advanced Display Sys., Inc. v. Kent State Univ.*, 212 F.3d 1272, 1281 (Fed. Cir. 2000)). The Federal Circuit has since held that a party need not renew its objections to the court's claim construction when the claim-construction jury instruction is given if the party's position was previously made clear to the court. *O2 Micro Int'l Ltd. v. Beyond Innovation Tech.*, 521 F.3d 1351, 1359 (Fed. Cir. 2008).

The court otherwise has discretion as to when it instructs the jury. Fed. R. Civ. P. 51. The timing of jury instructions can affect how useful the instructions are in educating the jury and assisting them in understanding the case.

Particular issues concerning preliminary and final jury instructions on substantive issues of law, including the requirement to instruct the jury on the court's claim constructions, are discussed in the previous chapter. *See* § 7.3. Here, we discuss jury management issues and techniques that can be employed during trial to assist the jury and improve their comprehension, including admonitions, jury binders and note-taking, and allowing juror questions and transitional statements by counsel.

8.1.2.3.2.1 Jury Admonitions

Besides preliminary and final jury instructions, there are limited instructions that the court should give to the jury during the presentation of evidence. Occasionally, evidence will be introduced for a limited purpose or through means other than witness testimony. During trial, the court should explain when the parties stipulate to testimony or facts or introduce evidence through discovery. In addition, instructions regarding the limited purpose of evidence should be given during trial at the time the evidence is introduced.

Other than that, the main instructions given during trial are admonitions to the jury. The court should inform the jurors that whenever they are allowed to separate (during breaks or at the end of each day), they should not discuss the case with anyone and should immediately inform the court if approached by anyone regarding the case. Typically, the admonition is given as part of the preliminary instructions. It is useful to remind the jury of this duty once trial begins, although it may not be necessary to admonish the jurors before each separation.

The prohibition against communications regarding the case typically extends to discussions between the jurors as well, barring any discussions of evidence until formal deliberations. The concern is that jurors may form an opinion before consideration of all evidence. Adherence to early formed beliefs is thought to prejudice defendants as plaintiffs put their case on first.

Recent studies, however, indicate that discussions before final deliberations do not lead to early verdicts. *See* Ninth Circuit Jury Trial Improvement Committee, Second Interim Report: Recommendations and Suggested Best Practices, Recommendation XV. Permitting jurors to discuss evidence during the course of trial can improve juror comprehension and reduce requests for read-back of testimony. Interim discussions also allow the jurors to clarify misunderstandings when they arise. Because private conversations between small groups of jurors can become divisive, interim discussions should only be allowed when all jurors are present.

Jury comprehension is of particular concern in patent matters. For that reason, interim jury deliberations can be a useful tool in maximizing jury comprehension. *See* Comments to Instruction 1.12, *Ninth Circuit Model Jury Instructions*. As the risk of prejudice falls more on one party than another, however, the court should consider the parties' positions on the matter before allowing interim jury discussions. In any event, the court should caution jurors to remain open-minded and not to make

a decision until all the evidence is presented. *United States v. Klee*, 494 F.2d 394 (9th Cir. 1974).

8.1.2.3.3 Juror Binders

The court can also improve the jury's understanding of the case by providing written information for the individual jurors to take with them to the jury room. The information presented in a patent case can be difficult to digest and remember. Providing jurors with binders containing key information can enhance jurors' memory and their deliberations. See Ninth Circuit Jury Trial Improvement Committee, *Second Interim Report: Recommendations and Suggested Best Practices*, Recommendation X.

The information contained in the binders should include a copy of the preliminary jury instructions. Having a copy of the preliminary instructions enables the jurors to refer back to the rules that guide their conduct and outline their duties during trial. The binders can also be updated with the final jury instructions once they are given, so that the jurors will have them as reference during deliberations. The binders can also be used as a tool to aid the jurors' memory. The parties may often refer back to the testimony of certain witnesses. Having photographs of the witnesses in the jury binders will help the jurors remember who the parties are talking about.

In a patent trial, it is also helpful to include copies of the patent at issue so that the jurors may review it during testimony or when otherwise necessary. The meaning of the terms in the patent claims are determined by the court and central to many of the issues the jury must resolve. Accordingly, a copy of the court's claim construction should also be included to assist the jurors' reading of the patent. The patent and the parties' presentations will likely include other technical terminology. It is therefore advisable for the parties to identify and prepare jointly a glossary of technical and legal terms to be included as reference.

Jury instructions, photographs, the patents, and a glossary are relatively non-partisan items that the parties can agree to include in the jury binders. The inclusion of key trial exhibits can also be helpful to the jury. Reaching agreement on a reasonable set of exhibits to include, however, may be difficult. Individual exhibits can be voluminous, and narrowing down specific exhibits can become contentious as each side will want to ensure its preferred exhibits are included. Identification and inclusion of the principal prior art references can be similarly challenging. If the parties can agree to a reasonable set, then exhibits and prior art should also be included in the binders. Otherwise, it may be best to limit the juror binder items to less controversial information.

8.1.2.3.4 Jury Note-Taking

The court should allow, even encourage, the jurors to take notes by providing notepads and pencils. Given the length and technical nature of most patent trials, having notes to review will help the jurors understand and remember the case. See, e.g., Ninth Circuit Jury Trial Improvement Committee, *Second Interim Report: Rec-*

ommendations and Suggested Best Practices, Recommendation X. It also helps to focus the jurors' attention during the proceedings.

Juror notes are confidential and should not leave the courtroom during trial. The court should instruct the jury to leave their notes in the jury room when court is not in session. The jurors should also be discouraged from sharing their notes with one another. See *United States v. Balsam*, 203 F.3d 72, 86 (1st Cir. 2000). Notes reflect individual impressions and jurors should not rely on other people's interpretation of the evidence. Indeed, jurors should be admonished not to put too much emphasis on even their own notes. *United States v. Rhodes*, 631 F.2d 43, 46 (5th Cir. 1980); Ninth Circuit Model Jury Instruction 1.11. With proper restrictions in place, however, juror note-taking can be a useful and beneficial practice in a patent jury trial.

8.1.2.3.5 Allowing Juror Questions

Courts can also allow jurors to submit questions to improve the jury's level of attentiveness and comprehension during trial. *United States v. Huebner*, 48 F.3d 376, 382 (9th Cir. 1994), *cert. denied*, 516 U.S. 816 (1995). Some courts discourage juror questioning as it risks the jury's neutrality. See, e.g., *United States v. Richardson*, 233 F.3d 1285, 1290 (11th Cir. 2000); *United States v. Ajmal*, 67 F.3d 12, 14 (2d Cir. 1995); *United States v. Sutton*, 970 F.2d 1001, 1005 (1st Cir. 1992); *DeBenedetto v. Goodyear Tire & Rubber Co.*, 754 F.2d 512, 516 (4th Cir. 1985). Allowing questions also risks the jurors' making premature decisions regarding the evidence.

If the court allows juror questioning, it should establish procedures to protect against these concerns. The court can ensure the propriety of juror questions by requiring any questions the jury may have for a witness to be submitted to the court in writing first. See, e.g., Ninth Circuit Model Jury Instruction 1.15. The questions should then be submitted to counsel outside the presence of the jury so that the jury will not attribute any changes to, or rejection of, their questions to a particular party. The court should hear from counsel before deciding whether to ask the question, reject the question, or modify it as appropriate.

The procedures for juror questions, if permitted, should be included in the preliminary jury instructions. The court should make clear that questions should be reserved for extraordinary circumstances, and that numerous questions can slow down proceedings.

8.1.2.3.6 Transition Statements by Counsel to the Jury

The court can allow counsel to make interim statements to the jury to help explain the significance of the evidence and testimony presented. The presentation of evidence in a jury trial cannot always be organized discretely by the issues the jurors must decide. It can, therefore, be difficult for jurors to synthesize information and identify the significance of evidence presented, particularly in lengthy and complex cases.

Interim attorney statements can serve as signposts for the jury, explaining the purpose of testimony and how the evidence fits into a party's overall case. Allowing

counsel before or after a witness examination to clarify the purpose of the testimony will help jurors understand the facts. This approach can be especially helpful when there is extensive expert testimony broken up into different infringement and invalidity issues.

To guard against misuse of attorney argument, the court should limit the amount of time the parties can use for such statements and should caution against argument. *See, e.g.,* Ninth Circuit Jury Trial Improvement Committee, *Second Interim Report: Recommendations and Suggested Best Practices*, Recommendation XV (recommending fifteen minutes per side to use as they wish during trial).

8.1.2.3.7 Jury Education and Tutorials

Because of the complexity of patent and technological issues at play, jury education is a serious concern in patent trials. Not only must the jury be educated in the applicable patent law, but it must also learn about the technology of the patents involved. To the extent the parties can agree on neutral tutorials, the court should encourage their use.

As noted in § 7.3.1, a video produced by the Federal Judicial Center, which provides an overview of the patent process, together with a mock sample patent for distribution to prospective jurors, has been used as part of the preliminary jury instructions to introduce patent procedure and patent law to the jury. The FJC updated that video in 2013 to address changes to patent law and implementation of the America Invents Act. This video, “The Patent Process: An Overview for Jurors,” can be found here: <https://www.youtube.com/watch?v=ax7QHQTbKQE>.

Alternatively, the court might consider requiring the parties to prepare a preliminary instruction that provides a fair and accurate overview of the current state of the law. The parties and the court can use the Northern District of California’s Preliminary Instruction A.1 (“What A Patent Is And How One Is Obtained”) as a guide in crafting such an instruction. *See* Model Patent Jury Instructions (May 2014). These instructions can be found in Appendix E. *See also* Federal Circuit Bar Association, Model Jury Instructions (Jan. 2016) (contained in Appendix E).

Neutral technology tutorials have historically been difficult to procure. Parties are rarely able to prepare and agree on nonargumentative technology tutorials. Even when the parties agree on a joint tutorial, there is risk that one party is being taken advantage of and that the tutorial is not neutral. More often, the parties will insist on presenting separate tutorials. Competing tutorials are not any more helpful to the jury than having the parties explain the technology through their witness examinations.

8.1.2.4 Special Masters, Court-Appointed Experts, or Technical Advisors

Often in patent litigation a judge needs help understanding the technology involved. The simplest solution is for the parties’ attorneys or experts to provide a tutorial on the technology. If this is not sufficient, the court has several means of obtaining more direct expert assistance: appointing a special master, appointing a court

expert, or appointing a technical advisor. We previously touched on this topic with regard to claim construction in § 5.1.2.2.2.

A special master renders initial decisions for the court on technical matters. The special master is appointed pursuant to Federal Rule of Civil Procedure 53 and can hear evidence and argument from the parties and render an initial decision on substantive matters, such as claim construction or summary judgment. The initial decision is made in the form of a report or recommendations, which are provided to the parties and the court. The parties then must be given an opportunity to make objections to the special master's report, and the report and any objections are reviewed by the court. In this process, the court may, but is not required to, receive additional evidence. The court finally adopts, rejects, or modifies the special master's report, applying a de novo standard to factual and legal decisions and an abuse-of-discretion standard to procedural decisions.

A court expert, like party experts, ultimately provides the court with expert testimony to be taken into account along with other evidence in rendering a decision. The court expert is appointed pursuant to Federal Rule of Evidence 706 and, as required by that rule, must be provided with initial written instructions by the court. See generally *Regents of the Univ. of Cal. v. Oncor Inc.*, No. C-95-3084-VRW, 1997 U.S. Dist. LEXIS 15068, 1997 WL 670674, at *18 (N.D. Cal. Aug. 19, 1997). After completing an analysis, the expert provides findings to the parties and the court, much like any expert's report. Any party may then depose the expert. Finally, the expert provides the court and, if present, the jury with the results in the form of expert testimony, subject to the same cross-examination as party experts. The Federal Circuit affirmed a district court's use of a court-appointed expert pursuant to Federal Rule of Evidence 706 in *Monolithic Power Sys., Inc. v. O2 Micro Int'l Ltd.*, 558 F.3d 1341 (Fed. Cir. 2009). The district court had allowed the parties to show cause why an expert should not be appointed, allowed the parties to mutually agree on an expert, provided detailed written instructions to the expert, and ordered the expert to make himself available for depositions and examination at trial. In addition, the court allowed the parties to continue to have their own experts and specifically instructed the jury not to assign the court-appointed expert any greater weight. Because the district court properly administered the standards set by Federal Rule of Evidence 706, the Federal Circuit held there was no abuse of discretion. The Federal Circuit noted, however, that the "predicament inherent in court appointment of an independent expert and revelations to the jury about the expert's neutral status trouble [the] court to some extent," and admonished that use of court-appointed experts should be limited to the rare and exceptional cases. For similar reasons, parties usually will not favor allowing a court-appointed expert to testify to a jury, and if the expert does testify, will not favor identifying the expert as "court-appointed" or "neutral."

A technical advisor functions as an advisor to the judge on technical matters in a manner often analogized to a law clerk, although case law views the analogy as imperfect. The advisor is appointed pursuant to the court's inherent power. It is a power to be used "sparingly," but appointment is proper in any highly technical case where the science or technology is well beyond the experience of the judge. Im-

portantly, if the advisor provides no evidence to the court, Federal Rule of Evidence 706 does not apply and, as a result, the parties have no right to a deposition or other disclosure of the advisor's opinions or communications with the court. Alternatively, a person can be appointed as both a court expert and an advisor, in which case Federal Rule of Evidence 706 applies.

Best practices for use of technical advisors are set out in a quartet of appellate court cases: *FTC v. Enforma Natural Products, Inc.*, 362 F.3d 1204, 1213–15 (9th Cir. 2004); *TechSearch LLC v. Intel Corp.*, 286 F.3d 1360, 1378–79 (Fed. Cir. 2002) (applying Ninth Circuit law); *Association of Mexican-American Educators v. California*, 231 F.3d 572, 611–14 (9th Cir. 2000) (en banc) (Tashima, J., dissenting); and *Reilly v. United States*, 863 F.2d 149 (1st Cir. 1988). See generally § 5.1.2.2.2.1. These cases focus on several procedural aspects of the technical advisor process to ensure the technical advisor does not improperly introduce new evidence unknown to the parties or influence the court's resolution of factual disputes. First, the court should assure a fair and open procedure to appoint a neutral advisor. Second, the advisor explicitly should be given a clearly defined, proper role that ensures there is no impingement on the court's role as fact finder. Third, the court should provide some assurance that the advisor remains within that proper role. Use of these procedures also facilitates appellate review of the propriety of the technical advisor's role.

To ensure fairness in the appointment, the court should identify the proposed advisor to the parties in advance of the appointment. This process can involve inviting the parties to propose advisors, either separately or together after consultation. If the parties are asked to provide potential advisors, the court should establish, in advance, limits on the contact the parties may have with prospective advisors. Alternatively, the court can identify a proposed advisor to the parties—potentially, an advisor the judge worked with previously—without prior consultation. In either case, the parties should be allowed to challenge the advisor's bias, partiality, or lack of qualification. If any challenge is raised, the court should address it on the record.

The proper role of the advisor is to be a sounding board or tutor who aids the judge's understanding of the technology. This includes an explanation of the jargon used in the field, the underlying theory or science of the invention, or other technical aspects of the evidence presented by the parties. The advisor can also assist the judge's analysis by helping think through critical technical problems. In this latter function, case law admonishes that the court must be careful to assure that the decision making is not delegated to the advisor. Although in form much like the interaction between a judge and law clerk, the situation is different in that, because of a judge's knowledge of law, a clerk cannot usurp the judicial role; in contrast, a technical advisor in an area of science unfamiliar to the judge potentially could.

Within these parameters, the advisor properly can aid the judge's understanding and analysis throughout a patent case. This can include helping the judge understand the patent specification and claims, expert affidavits and testimony provided by the parties, and scientific articles that may be offered as prior art. Proper subjects for consultation with the advisor include whether technical facts are in dispute in a summary judgment motion, claim interpretation, validity and infringement questions, the proper articulation of technical issues for jury instructions, and the admis-

sibility of proffered scientific evidence under *Daubert*. The advisor, however, may not provide evidence, either documentary or testimony, without compliance with Federal Rule of Evidence 706. The advisor’s advice therefore cannot be based on extra-record information (except the use of technology-specific knowledge and background used to educate the judge), and the advisor cannot conduct any independent investigation. Particularly in situations in which the advisor assists the judge’s efforts to resolve factual conflicts, the judge and advisor should be vigilant to avoid the advisor unduly influencing the judge’s decision making. In no circumstance, of course, should the advisor become an advocate for any party or position.

The court or advisor should confirm that the advisor’s work is done within proper parameters for the benefit of both the parties and appellate review. There is no fixed requirement how this should be accomplished. Proper means include supplying a transcript of the advisor’s communications with the judge, providing a report by the advisor of the work performed and any communications had with the judge, or obtaining an affidavit from the advisor at the outset of the work committing to perform within a description of a proper scope of work and procedures (as outlined above) and obtaining a second affidavit at the conclusion attesting to compliance with the job description in the initial affidavit.

8.2 General Evidentiary Issues

In every trial, it is inevitable that the court will have to resolve evidentiary issues. The parties may dispute whether a witness’s testimony is appropriate, whether certain exhibits should be admitted, and the proper use of demonstratives. In this section, we discuss the typical evidentiary issues that arise in a patent case and the considerations the court should keep in mind when deciding these issues.

8.2.1 Witnesses

8.2.1.1 Patent Law Experts

Parties sometimes propose presenting expert testimony regarding patent law, procedures of the USPTO, patent terminology, the prosecution history, and specific substantive (e.g., anticipation) and procedural (e.g., what a “reasonable patent examiner” would find material) issues through a patent attorney or former USPTO employee. In support of this testimony, parties often point out that the evidence rules specifically permit opinions on ultimate issues (Fed. R. Evid. 704) and the presentation of testimony without first specifying underlying facts or data (Fed. R. Evid. 705).

Testimony on issues of law by a patent law expert—as contrasted with a general description of how the patent process works—is usually deemed inadmissible. Just as in any other field, it is exclusively for the court, not an expert, to instruct the jury regarding underlying law. *See, e.g., Burkhart v. Wash. Metro. Area Transit Auth.*, 112 F.3d 1207, 1213 (D.C. Cir. 1997). Testimony regarding the procedures and terminology used in patents and file histories, on the other hand, often is allowed. *See, e.g., Bausch & Lomb, Inc. v. Alcon Labs., Inc.*, 79 F. Supp. 2d 252, 255–58 (W.D.N.Y.

2000). In many cases, however, this testimony might be redundant in light of a preliminary jury instruction explaining those procedures. Because a jury instruction is likely to be more neutral, it usually will be a preferable means of providing this information to the jury. An instruction, however, may lack sufficient specificity to explain a USPTO procedural event relevant in a particular case, and in that circumstance, expert testimony is more likely to be appropriate and helpful to the jury.

The admissibility of proffered patent expert testimony on ultimate issues will often depend on whether the expert is doing anything more than applying patent law to a presumed set of facts, essentially making the jury's determination. This particularly is true if the proffered patent expert has no relevant technical expertise. Thus, a patent expert's opinion regarding such matters as infringement, obviousness, and anticipation based on technical conclusions that are assumed or provided by a different expert is usually improper. Similarly, testimony applying patent law to issues intertwined with patent procedure, but dependent on technical conclusions supplied by others, such as the appropriate priority date of a claim in a continuation application, is usually inappropriate. On the other hand, if the patent expert also has relevant technical expertise, he or she should be equally able to provide expert testimony within that expertise as would be any nonlegal expert with similar technical expertise.

In trials to the court, when there is no concern regarding jurors' overreliance on expert testimony, courts more freely admit the testimony of patent law experts. This includes, for example, testimony regarding whether a reasonable patent examiner would deem particular prior art or statements important in an inequitable conduct determination. Courts have found such testimony helpful and allowed it. *See, e.g., Bristol-Myers Squibb Co. v. Rhone-Poulenc Rorer, Inc.*, 326 F.3d 1226, 1238 (Fed. Cir. 2003); *PerSeptive BioSystems, Inc. v. Pharmacia Biotech, Inc.*, 12 F. Supp. 2d 69, 74 (D. Mass. 1998), *aff'd*, 225 F.3d 1315 (Fed. Cir. 2000).

Finally, testimony is sometimes offered regarding the abilities of patent examiners, their workloads, time spent on applications, or similar matters. This testimony, which is meant to bolster or undermine the statutory presumption of validity, is improper. § 282; *see also Applied Materials, Inc. v. Advanced Semiconductor Materials Am., Inc.*, No. 92-20643, 1995 U.S. Dist. LEXIS 22335, 1995 WL 261407 (N.D. Cal. Apr. 25, 1995). The deference the jury should give to the actions of the patent examiners is an issue of law like any other. *See A & L Tech. v. Resound Corp.*, Case No. C 93-00107 CW, 1995 U.S. Dist. LEXIS 22443, at *11, 1995 WL 415146 (N.D. Cal. June 29, 1995) ("As a matter of law, a patent examiner is presumed to have conducted her own independent analysis of the prior art and drawn her own conclusions."); *see also Al-Site Corp. v. VSI Int'l Inc.*, 174 F.3d 1308, 1323 (Fed. Cir. 1999); *Am. Hoist & Derrick Co. v. Sowa & Sons, Inc.*, 725 F.2d 1350, 1359 (Fed. Cir. 1984). The appropriateness of that deference is not an issue for jury resolution.

8.2.1.2 Inventor and Other Technical Party Employee Testimony

Inventors and other technical employee witnesses often testify at trial regarding the invention and other technical matters. These witnesses frequently qualify as ex-

perts, and if properly disclosed as testifying experts, appropriately may provide expert testimony. Because their duties likely do not “regularly involve giving expert testimony,” no expert report is required by such employees absent special order; however, ordering such a report usually is appropriate and is a provision that might be included in the case-management conference order. *See* Fed. R. Civ. P. 26(a)(2)(B); § 2.6.

If inventors and other technical employees are not disclosed as experts, difficult line-drawing can arise regarding their testimony. For example, when an inventor or co-employee testifies regarding the invention to a jury, it usually is necessary to accompany the testimony regarding historical acts with an explanation of the technology involved. These explanations are sometimes challenged as undisclosed expert testimony. Other testimony that often draws a challenge is inventor or employee testimony regarding the nature of the prior art at the time the invention was made. While testimony about the invention and about the prior art may be highly technical, it may involve the description of historical facts without the expression of opinion. In that event, the testimony is proper without expert disclosure. Such testimony, however, is sometimes employed to attempt to introduce undisclosed opinion testimony. A similar issue is presented by testimony aimed at teaching the relevant science to a jury; this, too, may be appropriate testimony without expert disclosure, but also is an opportunity sometimes used to attempt to introduce undisclosed expert testimony.

8.2.2 Exhibits

Due to the technical nature of patent cases, the number of potential exhibits can be substantial. Parties tend to be overinclusive with their exhibit lists to minimize the risk that they will later be precluded from using a particular document during trial. A final decision on whether an exhibit will be used is often not made until the middle of trial. The sheer volume of exhibits makes it difficult for the parties and the court to arrive at any meaningful refinement of exhibits prior to trial.

In general, resolving all evidentiary issues and preadmitting exhibits prior to trial saves trial time and reduces the burden on the jurors who would otherwise have to wait while the court resolves exhibit disputes with the parties. One way the court can achieve this end is by placing the burden of agreeing on exhibits on the parties. The court can deem all exhibits admitted, unless a party raises specific objections with the court in advance of trial. The burden of having to articulate specific and defensible objections to the court often compels parties to act reasonably when conferring with the opposing side, leaving only genuine disputes for the court.

This approach, however, requires the parties and the court to expend a significant amount of time deciding the admissibility of an exhibit that the parties may ultimately never use at trial. Another approach is to defer decision on exhibits until a party intends to introduce them. The court should have the parties adopt an exhibit disclosure schedule that provides enough time for the parties to confer over objections and raise issues with the court in advance. Typically, a party should identify the

exhibits it intends to use two days in advance, giving the court a day to consider the issue if the parties cannot resolve it on their own.

A copy of any exhibits admitted into evidence should be provided to the jurors during deliberations. The court should keep a record of exhibits admitted into evidence and order the parties to prepare a set for the jury room.

Another issue that often arises in patent cases in the context of trial exhibits is the authentication of exhibits used as prior art. With the proliferation of information on the Internet, litigants often rely on prior art references located on the Internet. These prior art references are still subject to usual rules of authentication. *In re Wyer*, 655 F.2d 221, 227 (C.C.P.A. 1981) (party seeking to introduce a reference as prior art must “produce sufficient proof of its dissemination or that it has otherwise been available and accessible to persons concerned with the art to which the documents relates”).

As litigants increasingly rely on the Internet to uncover articles, papers, manuals, and other publications that they intend to rely on as prior art, disputes over authenticity are becoming more frequent. Typically publication in a scientific journal is enough to establish a reference’s date of availability to the public and status as prior art. *Duramed Pharm. Inc. v. Paddock Labs, Inc.*, 644 F.3d 1376, 1382 n.2 (Fed. Cir. 2011), citing *In re Lister*, 583 F.3d 1307, 1313 (Fed. Cir. 2009). Other types of publications retrieved from Internet sources, however, require authentication of the date of publication. A date on a document, with nothing more, is usually insufficient to authenticate the document as prior art. See *ResQNet.com, Inc. v. Lansa, Inc.*, 533 F. Supp. 2d 397, 414 (S.D.N.Y. Feb. 1, 2008) (disregarding a publication as prior art where no witness testified and no evidence was presented as to date of publication other than a date on the document itself). Some evidence from a witness or a library setting forth procedures and date of cataloging is needed for authentication. *In re Enhanced Security Research, LLC*, 739 F.3d 1347, 1354–55 (Fed. Cir. 2014) (dated software manual authenticated as prior art only when taken into consideration with declaration of software company’s CEO attesting to date of publication); *In re NTP, Inc.*, 654 F.3d 1279, 1294–96 (reference was authenticated based on attestation of university library that date-stamped and catalogued the reference).

In recent years, there has been an increased reliance on early webpages retrieved from the Wayback Machine (available at <http://archive.org/web/>) to establish prior art systems or disclosures. The Wayback Machine is operated by a company called the Internet Archive which seeks to catalogue all websites on the Internet. Party attestations as to the retrieval of screenshots, disclosures, or webpages from the Wayback Machine is insufficient to authenticate such exhibits as prior art. Instead, most courts require an affidavit from a representative of the Internet Archive with personal knowledge of the specific contents of the Internet archive at issue. See *Specht v. Google, Inc.*, 758 F. Supp. 2d 570, 580 (2010); see also *United States v. Bansal*, 663 F.3d 634, 667–68 (3d Cir. 2011) (requiring testimony on how the Wayback Machine works, its reliability, and comparison of screenshots before authenticating screenshots obtained from the Wayback Machine as evidence).

8.2.3 Demonstratives

Demonstratives can be especially useful tools in patent cases. They help the parties explain background technology to the court and the jury. Because demonstratives are not evidence, however, they are not admitted into the record and do not need to meet admissibility requirements. There must, nonetheless, be a foundation for the use of demonstratives. Specifically, demonstratives can be used if they are fair representations and assist the jury in understanding a witness's testimony.

A court has broad discretion in managing the use of demonstratives. A court can preclude the use of a demonstrative if its utility in illustrating concepts to the jury is outweighed by the risk of unfair prejudice, confusion to the jury, or undue delay of time. Fed. R. Evid. 403. As with exhibits, the court should require the parties to exchange demonstratives in advance of their intended use in court. If the parties cannot resolve any objections, the court can then decide whether any proposed demonstratives advance inappropriate arguments or are unduly prejudicial before they are presented to the jury.

Because demonstratives are not evidence, they are excluded from the jury room during deliberations. A party may, on occasion, ask that a demonstrative be admitted into evidence. Courts have discretion to admit into evidence demonstratives that summarize admissible evidence. Fed. R. Evid. 1006. The court should encourage the parties to confer about what demonstratives can be admitted into evidence.

8.2.4 Limits on Attorney Argument

Because patent trials typically are longer and more complex than most other cases, the court should take proactive measures to discourage the parties from prolonging trial with unnecessary and contentious arguments. Owing to the massive amounts of evidence involved in patent cases, disputes over arguments and objections to evidence during trial is unavoidable. The court can, however, make efforts to minimize sidebars and improper attorney argument.

To discourage extended attorney argument while the jury is present, the court should charge any time spent in sidebars and arguing objections to the party that loses the argument. The court should also remind the parties to refrain from extended argument when making objections. Giving the parties an outlet to make interim attorney arguments can reduce the likelihood that they will make improper or protracted arguments at other times during the trial.

During the course of a witness's testimony, a party may object to a particular subject of examination. The court should encourage the examining party to focus on another topic, if possible, until the jury is released. The court can then resolve the issue with the parties without wasting the jury's time.

8.3 Specific Substantive Issues

In addition to general evidentiary issues, patent trials present the court with substantive issues unique to patent law. The court must be familiar with considerations

that arise in the context of proving infringement or invalidity. The patent law also provides a patent owner with remedies other than compensatory damages that are within the court's discretion to award. This section will discuss substantive proof issues that the court should be aware of when presiding over a patent trial.

8.3.1 Limitations on the Number of Asserted Claims

Patent cases can sometimes involve dozens of patents with hundreds of claims asserted against multiple defendants. Because management of such cases can be unwieldy, the court should consider limiting the number of claims that a patentee may assert. See *Fenster Family Patent Holdings, Inc. v. Siemens Med. Sols.*, Case No. 04-0038, 2005 U.S. Dist. LEXIS 20788, 2005 WL 2304190 (D. Del. Sept. 20, 2005) (reducing number of asserted claims from ninety to ten); *Verizon Cal., Inc. v. Ronald A. Katz Tech. Licensing, L.P.*, 326 F. Supp. 2d 1060, 1066 (C.D. Cal. 2003) (requiring plaintiff to select three representative claims per asserted patent); *Auto Wax Co. v. Mark V Prods.*, Case No. 99-cv-0982, 2001 WL 292597 (N.D. Tex. Mar. 14, 2001) (limiting claims to be tried from eighty-six to nineteen); see also *LML Patent Corp. v. JPMorgan Chase & Co.*, Case No. 08-cv-448, 2010 U.S. Dist. LEXIS 136452, 2010 WL 5140823 (E.D. Tex. Oct. 12, 2010) (court's scheduling order limiting plaintiff to ten asserted claims).

While limiting the number of asserted claims may be necessary for effective and efficient case management, care must be given to avoid violating a patentee's due process rights with respect to nonselected claims. Specifically, where nonselected claims present distinct issues of infringement and invalidity not addressed by the asserted claims, a patentee should be given an opportunity to litigate those patent claims on the merits. See *In re Katz Interactive Call Processing Patent Litig.*, 639 F.3d 1303, 1312–13 (Fed. Cir. 2011) (suggesting that an order refusing to allow a plaintiff to add claims after a showing that such claims presented unique issues as to liability or damages may be subject to review or reversal). A plaintiff should furthermore be afforded sufficient opportunity to determine (through discovery or otherwise) whether particular claims may raise distinct issues of infringement and invalidity before the court imposes any claim selection order. *Id.* at 1313 n.9.

Where a plaintiff is given an opportunity, but fails either to assert or demonstrate that the nonselected claims raised issues that are not duplicative of the issues raised by the selected claims, a court is free to enter final judgment as to all claims based only on adjudication of the selected claims. *Id.* at 1313.

Where a plaintiff demonstrates that nonselected claims present unique liability or damages issues, however, the court should either sever and stay proceedings with respect to the nonselected claims or dismiss the nonselected claims without prejudice to plaintiff's ability to reassert them in a subsequent lawsuit. In the event a plaintiff decides to pursue the unselected claims, it may be more judicially efficient to sever and stay proceedings, allowing the parties and the court to retain the benefit of earlier proceedings in adjudicating the unselected claims. The parties may furthermore be able to resolve issues involving the unselected claims as part of resolution of the rest of the case.

In contrast, dismissal of unselected claims without prejudice may remove the threat of those claims from the immediate litigation, but may lead to redundant proceedings if the plaintiff elects to pursue claims in a subsequent lawsuit. With the unselected claims removed from the scope of the litigation, they are also less likely to be useful as leverage in resolving the case at hand.

8.3.2 Indirect Infringement

Patent infringement must be proven by a preponderance of evidence. The Federal Circuit requires proof of infringement to include an element-by-element analysis for each asserted claim in the patent and the accused product. In many patent cases, patent owners not only allege direct infringement, but that a defendant contributes to or induces another's infringement. The direct infringement underlying a contributory infringement or inducement claim is usually committed by a nonparty to the action. Disputes can arise during trial as to whether the evidence of the underlying direct infringement is sufficient to submit the issue to the jury.

While there must be evidence of underlying direct infringement, a nonparty's direct infringement can be proven through direct or circumstantial evidence. *Moleculon Research Corp. v. CBS, Inc.*, 793 F.2d 1261, 1271 (Fed. Cir. 1986). Circumstantial evidence of the indirect infringer's sales and dissemination of instructions for operation in an infringing manner can support a finding of direct infringement by customers. *Id.* Furthermore, there need not be evidence showing that every customer infringes; it is sufficient that the patentee present evidence from which the jury can infer that at least one customer directly infringes.

Inducement of infringement also requires proof that the alleged infringer intended to induce infringement by others. This includes proof of the infringer's actual knowledge or "willful blindness" to the existence of the patent and that the induced acts constitute infringement. *Global-Tech Appliances, Inc. v. SEB S.A.*, 131 S. Ct. 2060 (2011). Whether the infringer deemed the patent valid, however, is irrelevant. *Commil USA, LLC v. Cisco Sys., Inc.*, 135 S. Ct. 1920 (2015). Proof of intent can be inferred from the conduct of the alleged infringer. As a result, evidence that may otherwise be prejudicial for purposes of proving infringement may be admissible to show intent. If such evidence is admitted, the court should take care to give limiting instructions explaining the purpose of such evidence. Similarly, the alleged infringer may attempt to disprove an intent to infringe a valid patent with evidence from incomplete proceedings in the USPTO in which an interim ruling has found the relevant claims invalid. Evidence of such interim PTAB rulings generally is inadmissible to prove invalidity, because its probative value is substantially outweighed by the risk of unfair prejudice to the patentee (*see* § 7.5.4.5), and for the same reason it may be excluded as evidence of an alleged inducer's lack of intent. *See VirnetX, Inc. v. Cisco Sys., Inc.*, 767 F.3d 1308, 1324–25 (Fed. Cir. 2014).

8.3.3 Invalidity

8.3.3.1 Presumption of Validity

Like infringement, proof of invalidity must include an element-by-element analysis. Invalidity, however, must be shown by clear and convincing evidence as the law provides that patents are presumed valid. § 282; *Microsoft Corp. v. i4i Ltd. P'ship*, 131 S. Ct. 2238, 2242 (2011) (holding that § 282 requires an invalidity defense to be proved by clear and convincing evidence); § 7.3.4.3. This is often phrased as requiring evidence that convinces the trier of fact that it is “highly probable” that the patent is invalid. *See, e.g., Buildex, Inc. v. Kason Indus., Inc.*, 849 F.2d 1451, 1463 (Fed. Cir. 1988).

The jury does not have the discretion to disregard the presumption of validity. During trial, it is the alleged infringer’s burden to present evidence and argue that the presumption is rebutted. A party cannot argue that the presumption should not apply. *See Am. Hoist*, 725 F.2d at 1360 (stating that the statutory presumption of validity imposes a burden that “is constant and never changes and is to convince the court of invalidity by clear evidence”).

Where the prior art in question was before the USPTO during prosecution, the patent holder will argue that the presumption of validity is “especially difficult” to rebut. *See Glaxo Group Ltd. v. Apotex, Inc.*, 376 F.3d 1339, 1348 (Fed. Cir. 2004). Where the prior art in question was not considered by the USPTO during prosecution, the alleged infringer will argue that the presumption carries little weight. The burden of proof, however, remains the same regardless of whether the prior art reference was before the USPTO during prosecution. *See Microsoft Corp. v. i4i*, 131 S. Ct. at 2250 (rejecting fluctuating standard of proof based on whether evidence was considered by USPTO during prosecution). Where the evidence being considered was not before the USPTO during prosecution, it may “carry more weight” in meeting a defendant’s burden of proof, but it does not change the standard. *Id.* at 2251. Therefore, in both circumstances, the court should instruct the jury that an alleged infringer has the burden of presenting clear and convincing evidence before a patent can be found invalid. However, as discussed in § 7.3.4.3, the court should not instruct the jury about the presumption of validity itself—the court’s instruction that the jury is to weigh invalidity evidence according to a clear-and-convincing standard incorporates this presumption and is itself sufficient; advising the jury that there is a presumption risks jury confusion that the presumption is a separate hurdle, in addition to the burden of proof, that must be overcome to establish invalidity.

8.3.3.2 Obviousness

Claims of invalidity based on obviousness, in particular, often raise unique issues that require court resolution during trial. The ultimate conclusion of obviousness is a question of law, but it is premised on underlying findings of fact. *See KSR Int'l, Co. v. Teleflex, Inc.*, 550 U.S. 398, 404 (2007) (“The ultimate judgment of obviousness is a legal determination.”); § 7.3.4.4. Thus, while the ultimate conclusion rests with the court, resolution of the factual inquiries rests with the jury. The most common fac-

tual questions, known as the *Graham* factors, are: (1) the scope and content of the prior art; (2) the differences between the prior art and the claims at issue; (3) the level of ordinary skill in the art; and (4) objective evidence of nonobviousness. *Graham v. John Deere Co.*, 383 U.S. 1, 17–18 (1966). Establishing trial procedures that will assist the court in rendering a decision on obviousness will help to resolve later disputes regarding the propriety of the jury’s verdict on obviousness.

The Federal Circuit has held that submission to the jury of a question of law that is based on underlying facts, like obviousness, is proper when accompanied by appropriate instructions. *White v. Jeffrey Mining Co.*, 723 F.2d 1553, 1558 (Fed. Cir. 1983). Many courts follow this course in determining obviousness. When the jury is asked to determine obviousness, it is preferred that the jury be provided with special interrogatories regarding the *Graham* factors relevant to the case so that the jury’s underlying factual findings are known. See *Agrizap, Inc. v. Woodstream Corp.*, 520 F.3d 1337, 1343 n.3 (Fed. Cir. 2008). With the benefit of the answers to the special interrogatories, the district court on a renewed motion for judgment as a matter of law and the Federal Circuit on appeal can then review the jury’s ultimate conclusion on obviousness in light of its underlying factual determination. As explained by Justice Breyer:

Courts can help to keep the application of [the] “clear and convincing” standard within its proper legal bounds by separating factual and legal aspects of an invalidity claim, say, by using instructions based on case-specific circumstances that help the jury make the distinction or by using interrogatories and special verdicts to make clear which specific factual findings underlie the jury’s conclusions By isolating the facts (determined with help of the “clear and convincing” standard), courts can thereby assure the proper interpretation or application of the correct legal standard (without use of the “clear and convincing” standard). By preventing the “clear and convincing” standard from roaming outside its fact-related reservation, courts can increase the likelihood that discoveries or inventions will not receive legal protection where none is due.

Microsoft Corp. v. i4i Ltd., 131 S. Ct. 2238, 2253 (Breyer, J., concurring); see § 7.3.4.3. Formulating special interrogatories regarding all the relevant *Graham* factors sometimes can be difficult, for example, if multiple prior art references are asserted in multiple combinations. Because the alleged infringer usually will greatly prefer submitting special interrogatories to the jury, however, it generally is possible to negotiate with the parties a manageable number of special interrogatories for submission.

Alternatively, the court can submit only the relevant *Graham* factors to the jury for its determination through special interrogatories, with or without an advisory verdict on the legal question of obviousness, and then determine the ultimate question of obviousness itself based on the jury’s factual determinations. The model instructions of the Northern District of California (see Instruction No. 4.3b),³ for example, adopt this approach.

3. The Northern District of California’s Model Patent Jury Instructions are available online at [http://www.cand.uscourts.gov/cand/ForAttys.nsf/d07d1927bb07c86c88256d6e005ce658/4ed41e5a5972b27a88256d6e005cee5d/\\$FILE/NDmodel.101007.pdf](http://www.cand.uscourts.gov/cand/ForAttys.nsf/d07d1927bb07c86c88256d6e005ce658/4ed41e5a5972b27a88256d6e005cee5d/$FILE/NDmodel.101007.pdf).

8.3.4 Patent Damages

A patent owner is entitled to monetary damages to compensate for the infringement, as well as to the court's consideration of equitable remedies to prevent further infringement. In cases of willful infringement, the court has further discretion to increase damages to punish the infringer. Each of these remedies presents unique issues for the court. This section focuses on evidentiary issues relating to patent damages that may arise at trial. A fuller discussion of patent damages is set forth in §§ 14.4.3.2, 7.3.4.7, 7.4.3.3.2.2. We discuss enhanced damages for willful infringement or bad faith in § 9.2.2, which is addressed through a posttrial motion.

Section 284 provides that a patent owner is entitled to “damages adequate to compensate for the infringement, but in no event less than a reasonable royalty.” Even if both parties’ damages evidence is rejected, the fact finder must still determine what constitutes a reasonable royalty from the evidence. *Apple, Inc. v. Motorola, Inc.*, 757 F.3d 1286, 1327–28 (Fed. Cir. 2014) (quoting *Dow Chem. Co. v. Mee Indus., Inc.*, 341 F.3d 1370, 1381–82 (Fed. Cir. 2003)); see also *Info-Hold, Inc. v. Muzak LLC*, 783 F.3d 1365 (Fed. Cir. 2015) (reversing a summary judgment of zero damages even though the patentee’s damages expert’s report properly was struck “because there was no evidence of record supporting a zero royalty and the evidence of record which could be used to determine a non-zero royalty was ignored”).

The jury has wide discretion in awarding monetary damages within the evidentiary bounds set by the court. While the Federal Circuit has emphasized that any factual disputes relating to damages—including disputed facts within expert testimony, an expert’s choice of one of several acceptable methodologies, and issues relating to an expert’s credibility—are to be resolved by the jury, *Apple Inc. v. Motorola, Inc.*, 757 F.3d at 1313–20, the court has in recent years substantially enhanced the court’s gatekeeping role to ensure that a party’s proof of damages is not based on improper “principles and methodology, or legally insufficient facts and data,” *id.* at 1314, or a royalty base that is likely to mislead a jury, see *Ericsson, Inc. v. D-Link Sys., Inc.*, 773 F.3d 1201, 1226–27 (Fed. Cir. 2014). A patent owner can recover lost profits or a reasonable royalty or, in appropriate circumstances, a combination of the two.

8.3.4.1 Lost Profits

As set forth more fully in § 14.4.3.2.1.1, the patentee must prove a causal relationship between the infringement and its lost profits, encompassing the so-called DAMP factors: (1) demand for the patented product; (2) absence of acceptable non-infringing substitutes; (3) manufacturing and marketing capability to exploit the demand; and (4) profit he or she would have made. *Rite-Hite Corp. v. Kelley Co.*, 56 F.3d 1538, 1545 (Fed. Cir. 1995) (en banc) (citing *Panduit Corp. v. Stahlin Bros. Fibre Works, Inc.*, 575 F.2d 1152, 1156 (6th Cir. 1978)). The loss can include convoyed sales (nonpatented products and services) and price erosion owing to competition from the infringing products.

The first factor focuses on economic analysis of market conditions for the patented product. The second factor examines market definition and patent scope. With regard to the second factor, the Federal Circuit has cautioned against allowing

lost profits analyses to turn into separate full-blown infringement analyses on numerous other collateral products. See *Micro Motion, Inc. v. Kane Steel Co.*, 894 F.2d 1318, 1324 (Fed. Cir. 1990). Thus, while there needs to be at least some circumstantial evidence of the absence of noninfringing alternatives, such evidence need not include testimony by technical experts. *Dow Chem. Co. v. Mee Indus.*, 341 F.3d 1370, 1372 (Fed. Cir. 2003); *Northlake Mktg. & Supply, Inc. v. Glaverbel, S.A.*, 72 F. Supp. 2d 893, 898–99 (N.D. Ill. 1999). The question for the court is whether there is some evidence from which a jury can reasonably infer that there are no noninfringing alternatives, and that lost profits therefore are appropriate. Inventor testimony and claim charts, evidence that the alleged infringer failed to switch to noninfringing alternatives, and customer motivation to purchase the patented features have all been held sufficient. *Standard Havens Prods., Inc. v. Gencor Indus., Inc.*, 953 F.2d 1360, 1373 (Fed. Cir. 1991); *Kaufman Co. v. Lantech, Inc.*, 926 F.2d 1136, 1141–42 (Fed. Cir. 1991); *Datascope Corp. v. SMEC, Inc.*, 879 F. Supp. 820, 825 (Fed. Cir. 1989) (inventor testimony and claim charts sufficient for the jury to infer that substitutes were infringing).

The third factor focuses on engineering and marketing capacity.

The fourth factor—profit that would have been made, but for the infringement—is relatively straightforward when a single patent covers the entirety of a product, such as a drug, but can become complicated when the patent relates to but one component of a multicomponent product and is not the sole or predominant basis for consumer demand. In the latter circumstance, the loss to the patent holder must be apportioned between the patented and other features using “reliable and tangible” evidence. See *Ericsson, Inc. v. D-Link Sys., Inc.*, 773 F.3d 1201, 1226 (Fed. Cir. 2014) (citing *Garretson v. Clark*, 111 U.S. 120, 121 (1884)).

8.3.4.2 Reasonable Royalty

The reasonable royalty measure provides a floor for patent damages. It is typically the sole measure of monetary damages in cases involving nonpracticing entities, but can also arise in litigation between competitors where lost profits are difficult to prove or are an incomplete measure of the harm.

Patent law has long struggled to deal with apportioning patent value where a patent covers only one component of a larger product. See *Cincinnati Car Co. v. New York Rapid Transit Corp.*, 66 F.2d 592, 593 (2d Cir. 1933) (Learned Hand, J.) (observing that the allocation of profits among multiple components “is in its nature unanswerable”). The problem has become particularly acute in modern patent litigation as a result of the growing use of juries called on to apportion value based on complex and often widely divergent economic expert analyses.

As set forth more fully in § 14.4.3.2.1.4, a reasonable royalty may be derived from an established royalty (if one exists) or, more commonly, a hypothetical negotiation between the patentee and the infringer when the infringement began. The hypothetical negotiation, during which the asserted patent claims are assumed to be valid, infringed, and enforceable, seeks “to recreate the *ex ante* licensing negotiation scenario and to describe the resulting agreement.” *Lucent Techs., Inc. v. Gateway*,

Inc., 580 F.3d 1301, 1325 (Fed. Cir. 2009). For nearly half a century, courts have employed the vague and open-ended fifteen-factor test set forth in *Georgia-Pacific Corp. v. U.S. Plywood Corp.*, 318 F. Supp. 1116 (S.D.N.Y. 1970). See § 14.4.3.2.1.4.

The Federal Circuit has sought to prevent outsize damage awards by enhancing the judge’s gatekeeping role along several dimensions: focusing the jury’s attention on a royalty base that is closely connected to the patented component of a product, excluding unreliable damage theories, scrutinizing the admissibility of various forms of evidence, and providing limiting jury instructions.

In general, a patent holder seeking a reasonable royalty must provide substantial evidence supporting both its choice of royalty base and royalty rate. “[W]here multi-component products are involved, the governing rule is that the ultimate combination of royalty base and royalty rate must reflect the value attributable to the infringing features of the product, and no more.” *Ericsson, Inc. v. D-Link Sys., Inc.*, 773 F.3d 1201, 1226 (Fed. Cir. 2014) (citing *VirnetX, Inc. v. Cisco Sys., Inc.*, 767 F.3d 1308 (Fed. Cir. 2014)). “As a substantive matter, it is the ‘value of what was taken’ that measures a ‘reasonable royalty’ under § 284. What is taken from the owner of a utility patent (for purposes of assessing damages under § 284) is only the patented technology, and so the value to be measured is only the value of the infringing features of an accused product.” *Ericsson*, 773 F.3d at 1226 (quoting *Dowagiac Mfg. Co. v. Minn. Moline Plow Co.*, 235 U.S. 641, 648 (1915)).

8.3.4.2.1 Royalty Base

The royalty base has emerged as a critical part of reasonable royalty analysis. Where a single patent is the sole or predominant basis for consumer demand for a product, the royalty base is the value of the entire market for the product. See *Fonar Corp. v. Gen. Elec. Co.*, 107 F.3d 1543, 1552 (Fed. Cir. 1997) (citing *Rite-Hite Corp. v. Kelley Co.*, 56 F.3d 1538, 1549 (Fed. Cir. 1995) (en banc)).

Problems arise when the patent covers but one component of a complex product that cannot be shown to be the predominant driver of consumer demand for the product. In theory, the court could use the entire market value as the base and apply a sufficiently discounted royalty rate. But as the Federal Circuit has warned, “reliance on the entire market value might mislead the jury, who may be less equipped to understand the extent to which the royalty rate would need to do the work in such instances.” *Ericsson*, 773 F.3d at 1227 (citing *LaserDynamics, Inc. v. Quanta Computer, Inc.*, 694 F.3d 51, 67, 68 (Fed. Cir. 2012) (barring the use of too high a royalty base—even if mathematically offset by a “low enough royalty rate”—because such a base “carries a considerable risk” of misleading a jury into overcompensating, stating that such a base “cannot help but skew the damages horizon for the jury” and “make a patentee’s proffered damages amount appear modest by comparison” (quoting *Uniloc USA, Inc. v. Microsoft Corp.*, 632 F.3d 1292, 1320 (Fed. Cir. 2011))). The plaintiff’s expert in *Uniloc* posited a royalty base of \$19.28 billion (the entire market for Microsoft Office and Windows) to justify a reasonable royalty of over half a billion dollars for a patent on a product activation method.

To cabin the risk of outsize awards in multicomponent cases, the Federal Circuit has pushed the royalty base toward the smallest salable patent-practicing unit (SSP-

PU). In *Cornell University v. Hewlett-Packard Co.*, 609 F. Supp. 2d 279 (N.D.N.Y. 2009), the patent at issue related to software that issued multiple processor instructions at once, thereby increasing processor performance. It functioned as part of the instruction record buffer of a processor within a central processing unit (CPU) module of a CPU brick within a server—much like the flea on the hair of the tail of the dog. The plaintiff’s damages expert used the CPU brick as the royalty base, resulting in a royalty base of \$184 million. Judge Rader, sitting by designation, issued judgment as a matter of law reducing the jury’s damage award on the ground that the trial record contained “insufficient evidence to establish the required nexus between the patented aspect of the infringing processors and the entire CPU brick.” *Id.* at 292. Judge Rader remitted the jury award based on a royalty base derived from the market for the processor (\$53.4 million). While still above the instruction record buffer, the processor was the smallest saleable component relating to the patented invention.

The Federal Circuit embraced the SSPPU framework in *LaserDynamics Inc. v. Quanta Computer, Inc.*, 694 F.3d 51 (Fed. Cir. 2012), holding that “it is generally required that royalties be based not on the entire product, but instead on the ‘smallest salable patent-practicing unit.’ . . . The entire market value rule is a narrow exception to this general rule.” *Id.* at 67; *see also Commonwealth Scientific and Indus. Research Organisation v. Cisco Sys., Inc.*, 809 F.3d 1295, 1301–04 (Fed. Cir. 2015) (“CSIRO”); *VirnetX, Inc. v. Cisco Sys., Inc.*, 767 F.3d 1308, 1328–29 (Fed. Cir. 2014); *LaserDynamics, Inc. v. Quanta Computer, Inc.*, 694 F.3d 51, 66–70 (Fed. Cir. 2012); *Uniloc USA, Inc. v. Microsoft Corp.*, 632 F.3d 1292, 1320 (Fed. Cir. 2011); *Lucent Techs., Inc. v. Gateway, Inc.*, 580 F.3d 1301, 1336 (Fed. Cir. 2009).

More generally, the ultimate award “must be based on the incremental value that the patented invention adds to the end product.” *Ericsson*, 773 F.3d at 1226. Therefore, the patent holder must provide evidence that the claimed royalty base is a reasonable estimate—using such approximation as is necessary—of the value directly attributable to the elements of the product infringing one or more of the asserted patents, whether or not separately saleable. *See id.* at 1226–27; *CSIRO*, 809 F.3d at 1301–02; *VirnetX*, 767 F.3d at 1327–29; *Apple, Inc. v. Motorola, Inc.*, 757 F.3d at 1317–18. To avoid misleading the jury by placing undue emphasis on the value of the entire product, evidence of the loss to the patent holder or the gain to the alleged infringer from the entire market value of the product usually is inadmissible. *See Ericsson*, 773 F.3d at 1226–27; *LaserDynamics*, 694 F.3d at 68; *Uniloc*, 632 F.3d at 1320. This rule, however, is inapplicable when prior negotiations of a royalty rate for the patent at issue or comparable patents is offered, and those rates are based on the end product. *CSIRO*, 809 F.3d at 1302–04.

8.3.4.2.2 Royalty Rate

Beyond calibrating the royalty base to the scale of the patent practicing unit, the court must also ensure that the royalty rate is based on sound economic methodology and grounded in reliable and pertinent evidence. To establish an appropriate royalty rate, the patent owner often will “posit a ‘hypothetical negotiation’ between the patentee and adjudicated infringer and . . . ‘attempt[] to ascertain the royalty upon

which the parties would have agreed had they successfully negotiated an agreement just before infringement began.” *Aqua Shield v. Inter Pool Cover Team*, 774 F.3d 766, 770 (Fed. Cir. 2014) (quoting *Lucent Techs., Inc. v. Gateway, Inc.*, 580 F.3d 1301, 1324 (Fed. Cir. 2009)). The proof of an appropriate royalty rate using this method allows for necessary “approximation and uncertainty.” *Id.* at 771 (quoting *Lucent Techs.*, 580 F.3d at 1325). Nevertheless, it must be supported by substantial evidence, which usually will be based on the application of the *relevant*, but not necessarily the complete, list of fifteen *Georgia-Pacific* factors. See *WhitServe, LLC v. Computer Packages, Inc.*, 694 F.3d 10, 31–32 (Fed. Cir. 2012).

The open-ended *Georgia-Pacific* framework affords economic experts substantial leeway in determining a royalty rate. The most pertinent evidence is analogous license agreements. In many cases, however, the technology either has not been previously licensed or the licenses cover a broader range of technologies than the patented invention and/or multiple products or product components.

The most pertinent evidence for establishing a royalty rate will be past licenses to the infringing or comparable technology, the value of comparable features in the marketplace, an estimate of the value of the benefit provided by the infringed features by comparison to noninfringing alternatives, or an estimate of the cost to design around the patent. See *Ericsson*, 773 F.3d at 1227 (citing *Monsanto Co. v. McFarling*, 488 F.3d 973, 978 (Fed. Cir. 2007) (“An established royalty is usually the best measure of a ‘reasonable’ royalty for a given use of an invention . . .”)); *Georgia-Pacific Corp. v. U.S. Plywood Corp.*, 318 F. Supp. 1116, 1120 (S.D.N.Y. 1970) (finding that “royalties received by the patentee for the licensing of the patent in suit” is a relevant factor for the jury to consider); *VirnetX*, 767 F.3d at 1330–31; *Apple, Inc. v. Motorola, Inc.*, 757 F.3d at 1315, 1329; *ResQNet.com, Inc. v. Lansa, Inc.*, 594 F.3d 860, 871 (Fed. Cir. 2010); *Lucent Techs.*, 580 F.3d at 1327–28. The Federal Circuit noted, however, that “[p]rior licenses . . . are almost never perfectly analogous to the infringement action,” *Ericsson*, 773 F.3d at 1227 (citing *VirnetX*, 767 F.3d at 1330), but such differences “generally go[] to the weight of the evidence, not its admissibility,” *id.* (citing *Apple*, 757 F.3d at 1326).

Substantial evidence must explain why a license is sufficiently analogous to associate its royalty rate to a hypothetical license solely to the infringing technology if a purportedly comparable license is not to the infringing technology; it also includes other patents, other intellectual property, or physical products; or it was entered based on different economic circumstances. See *Ericsson*, 773 F.3d at 1227–28; *Uniloc*, 632 F.3d at 1316; *WordTech Sys. Inc. v. Integrated Networks Sols.*, 609 F.3d 1308, 1322, 1327 (Fed. Cir. 2010); *Lucent Techs.*, 580 F.3d at 1327–28. A prior license to the infringed patent with a royalty rate based on the entire market value of the product must be supported by testimony explaining how to discount the rate to account only for the value attributed to the licensed technology. Moreover, when such a license is admitted, if requested, the court should give a cautionary instruction explaining that it is for the limited purpose of helping to determine an appropriate royalty rate after apportionment to the incremental value of the product’s patented features. See *Ericsson*, 773 F.3d at 1227–28.

A license resulting from settlement of prior litigation usually is not admissible, but it can be admitted in the limited circumstance that it is the most reliable evidence available. See *LaserDynamics*, 694 F.3d at 77–78; *ResQNet.com*, 594 F.3d at 870–72. An example of this exception is a settlement that occurred after a finding that the patent is infringed. Such a settlement may be highly probative of a reasonable royalty, because its circumstance duplicates the hypothetical royalty assumptions that a patent is valid and infringed. *AstraZeneca AB v. Apotex Corp.*, 782 F.3d 1324, 1336–37 (Fed. Cir. 2015).

8.3.4.2.2.1 Rejection of General, Simplistic Apportionment Rules

As an alternative or shortcut to considering the *Georgia-Pacific* factors, some patentees have put forward general royalty theories such as the 25% rule and the Nash bargaining solution (50% split of net product value). The Federal Circuit has rejected the application of these generalized “rules of thumb.” See *Apple*, 757 F.3d at 1324–25; *VirnetX*, 767 F.3d at 1331–34 (rejecting the Nash bargaining solution); *Uniloc*, 632 F.3d at 1312 (rejecting the “25% rule”). Such evidence is inadmissible.

8.3.4.2.2.2 Consumer Surveys and Conjoint Analysis

Damages experts have begun to deploy consumer surveys to allocate value within multicomponent patented products. See Zelin Yang, Note, *Damaging Royalties: An Overview of Reasonable Royalty Damages*, 29 Berkeley Tech. L.J. 647, 664 (2014); S. Christian Platt & Bob Chen, *Recent Trends and Approaches in Calculating Patent Damages: Nash Bargaining Solution and Conjoint Surveys*, 86 Patent, Trademark & Copyright J. (BNA) 909 (Aug. 30, 2013). Marketing researchers have long used “conjoint analysis” to differentiate value within product configurations. See Paul E. Green, Abba M. Krieger & Yoram Wind, *Thirty Years of Conjoint Analysis: Reflections and Prospects*, 31 Interfaces 56 (2001); Paul E. Green and V. Srinivasan, *Conjoint Analysis in Marketing: New Developments with Implications for Research and Practice*, 54(4) J. of Marketing 3 (1990).

Conjoint analysis draws on consumer ranking of products with different features. Researchers use statistical methods to estimate consumers’ willingness to pay for particular attributes. While these methods provide a logical framework for differentiating value, the technique can be limited in practice. See Patricia Dyck, *Beyond Confusion—Survey Evidence of Consumer Demand and the Entire Market Value Rule*, 4 Hastings Sci. & Tech. L.J. 209, 226 (2012) (noting sensitivity to data collection methods and algorithms and the problem of combinatorial explosion); Lisa Cameron, Michael Cragg & Daniel McFadden, *The Role of Conjoint Surveys in Reasonable Royalty Cases*, Law360 (Oct. 16, 2013), <http://www.law360.com/articles/475390/the-role-of-conjoint-surveys-in-reasonable-royalty-cases>.

Courts have shown cautious receptivity to conjoint analysis. While recognizing the general admissibility of consumer surveys, Judge Alsup nonetheless rejected some of the expert’s conjoint analysis as unreliable while allowing some of it to be admitted in *Oracle America, Inc. v. Google, Inc.*, No. C 10-03571 WHA, 2012 U.S.

Dist. LEXIS 33619, 2012 WL 850705, at *10–14 (N.D. Cal. Mar. 13, 2012). In *TV Interactive Data Corp. v. Sony Corp.*, 929 F. Supp. 2d 1006 (N.D. Cal. 2013), Magistrate Judge Joseph Spero held the patentee’s expert testimony using conjoint analysis to be admissible. *Id.* at 1019–25.

8.3.4.2.2.3 FRAND/Standard Essential Patents

A growing number of technologies arise within the context of network industries in which standard protocols and interfaces promote technological innovation and greater consumer value. Industry standard-setting organizations such as the Institute of Electrical Electronics Engineers (IEEE) and the International Telecommunication Union (ITU) bring together company representatives to develop industry standards. To ensure that the industry standards reflect the best technologies while avoiding (or at least postponing) licensing disputes, the participants typically commit to license standard essential patents (SEPs) on “reasonable and non-discriminatory” (“RAND”) or “fair, reasonable and non-discriminatory” (“FRAND”) terms. The standard setting organizations have typically left the parameters for determining FRAND license terms undefined, see Mark A. Lemley, *Intellectual Property Rights and Standard-Setting Organizations*, 90 Cal. L. Rev. 1889, 1906 (2002), leaving courts with the difficult task of determining licensing rates for highly complex products involving potentially hundreds of patents.

The valuation of SEPs presents distinct problems. Industry standards can encompass hundreds of patented technologies of varying significance. Not surprisingly, owners of patents within a SEP pool often see their patents as particularly valuable, thereby risking hold-up and undue royalty-stacking. The challenge lies in separating the value of the particular technology from the often tremendous value of standardization. Once consumers adopt a product, they become locked into the standard to varying degrees. This could provide the patentee tremendous leverage in a negotiation. With potentially hundreds of SEPs and dozens of patent owners, the problem becomes intractable if patent owners stake out aggressive positions or refuse to propose licensing terms.

In a series of recent cases, courts have surmounted this challenge by interpreting the principal goal of standard-setting agreements to be widespread adoption of the standard by barring RAND licensors from capturing the coordination and network value of the standard. See § 14.4.3.2.1.4.2; *Microsoft Corp. v. Motorola, Inc.*, No. C10-1823JLR, 2013 U.S. Dist. LEXIS 60233, 2013 WL 2111217 (W.D. Wash. Apr. 25, 2013); see also *Ericsson*, 773 F.3d at 1229–35; *In re Innovatio IP Ventures LLC Patent Litig.*, No. 11 C 9308, 2013 U.S. Dist. LEXIS 144061, 2013 WL 5593609 (N.D. Ill. Oct. 3, 2013). The courts have adapted the *Georgia-Pacific* factors to serve the standard-setting context.

In such cases, the jury should be instructed as to what FRAND commitments have been made by the patent holder and the jury’s obligation to take those commitments into account when determining the royalty award, the need to apportion the value of the patented feature from any value added by adoption of the standard, those *Georgia-Pacific* or similar factors relevant (but *only* those relevant) in light of the evidence presented, and, if supported by the evidence, the issues of potential roy-

alty-stacking and patent hold-up. This might include directing the jury to consider a hypothetical negotiation date prior to adoption of the standard rather than at the time infringement began.

8.3.4.2.2.4 Indirect Infringement

There also are further complications when a patentee's damages are based on indirect infringement—such as the use of the patented invention by the alleged infringer's customers—particularly when the accused product is capable of non-infringing modes of operation. To recover damages based on use by customers, there need not be a one-to-one correspondence between the number of accused products sold and direct infringement by customers. *Lucent Techs.*, 580 F.3d at 1323–24; *Hilgraeve, Inc. v. Symantec Corp.*, 272 F. Supp. 2d 613, 621 (E.D. Mich. 2003); *Imagexpo, L.L.C. v. Microsoft Corp.*, 284 F. Supp. 2d 365, 370 (E.D. Va. 2003); *Black & Decker v. Bosch*, No. 04 C 7955, 2006 U.S. Dist. LEXIS 94556, at *6, 2006 WL 3883286 (N.D. Ill. Dec. 18, 2006). The patent owner, however, must present evidence sufficient for a jury to extrapolate or infer the extent of the customers' direct infringement. *Imagexpo*, 284 F. Supp. 2d at 370. Whether a party's experts' opinions comply with the requirements to prove or disprove damages often is—and may be required to be (see *Versata Software, Inc. v. SAP, Inc.*, 717 F.3d 1255 (Fed. Cir. 2013)) tested in a pretrial *Daubert* motion. See § 7.4.3.3.2.1. Whether as the result of such a motion or at trial, however, if a party fails to adhere to these standards, a court must be prepared to preclude testimony—including all of an expert's testimony, if necessary—or correct an award. See *Ericsson*, 773 F.3d at 1229–35; *ePlus, Inc. v. Lawson Software, Inc.*, 700 F.3d 509, 522–23 (Fed. Cir. 2012); *LaserDynamics*, 694 F.3d at 66–71; *Whitserve, LLC v. Comput. Packages, Inc.*, 694 F.3d 10 (Fed. Cir. 2012); *Uniloc*, 632 F.3d at 1319–20.

8.4 Motions for Judgment as a Matter of Law

As in any jury trial, once a party has completed its case-in-chief as to an issue, the party's opponent can move for judgment as a matter of law as to the issue. Fed. R. Civ. P. 50. Such motions are decided under the law of the circuit in which the district court sits. See, e.g., *Orion IP, LLC v. Hyundai Motor Am.*, 605 F.3d 967, 973 (Fed. Cir. 2010). The usual standard is that judgment will be denied if, “viewing the evidence in the light most favorable to the nonmoving party, and giving the non-movant the benefit of all reasonable inferences, there is sufficient evidence of record to support a jury verdict in favor of the non-movant.” *Honeywell Int'l Inc. v. Hamilton Sundstrand Corp.*, 370 F.3d 1131, 1139 (Fed. Cir. 2004) (en banc). These motions and their appellate implications, however, take on special significance in patent cases where each side has important claims and defenses as to which it bears the burden of proof, and where claim-construction issues often play a pivotal role.

The Federal Circuit applies the usual rule that, absent a Rule 50 motion before the case is submitted to the jury, specifically addressed to an issue, no argument can be made in posttrial motions or on appeal that the evidence is insufficient to support the jury's verdict as to that issue. *Unitherm Food Sys., Inc. v. Swift-Eckrich, Inc.*, 546 U.S. 394, 398 (2006) (“A post-trial motion for judgment can be granted only on

grounds advanced in the pre-verdict motion”); *Microsoft Corp. v. i4i Ltd. P’ship*, 598 F.3d 831, 857 (Fed. Cir. 2010), *aff’d on other grounds*, 131 S. Ct. 2238, (2011). The specificity of the predeliberations motion must be sufficient to alert the opponent as to the evidence that is omitted so that, if necessary, it may seek to reopen and provide that evidence. In the patent law context, this may require, for example, that a Rule 50 motion by an accused infringer specify the particular claim or claims as to which it asserts no infringement has been proven or the particular prior art references it contends render the patent obvious or anticipated, and that a motion by a patent owner specify the particular invalidity bases it asserts have not been proven. *Duro-Last, Inc. v. Custom Seal, Inc.*, 321 F.3d 1098, 1105–09 (Fed. Cir. 2003); *Union Carbide Chems. & Plastics Tech. Corp. v. Shell Oil Co.*, 308 F.3d 1167, 1187 (Fed. Cir. 2002); *Sw. Software, Inc. v. Harlequin Inc.*, 226 F.3d 1280, 1290 (Fed. Cir. 2000).

Circumstances in particular cases, however, may make much more cryptic motions sufficient if, in context, it is clear that the court and opposing party understood what was intended. *See, e.g., Western Union Co. v. MoneyGram Payment Sys.*, 626 F.3d 1361, 1367–68 (Fed. Cir. 2010) (holding that even a cursory motion suffices so long as it alerts the court and opposing party to the party’s position); *Orion IP, LLC*, 605 F.3d at 973–74 (“[W]e seek partial judgment as a matter of law based on prior art. And the Court has heard testimony and the argument about that” sufficient given context of motion.); *Blackboard, Inc. v. Desire2Learn, Inc.*, 574 F.3d 1371, 1379–80 (Fed. Cir. 2009) (cursory motion for anticipation and obviousness sufficient given context and court’s prompt that the motions would be taken under advisement). A predeliberations motion challenging the sufficiency of damages evidence is necessary for a posttrial objection to the reasonableness of a jury’s royalty award. *Compare Lucent Techs., Inc. v. Gateway, Inc.*, 580 F.3d 1301, 1311–16 (Fed. Cir. 2009), *with Wordtech Sys., Inc. v. Integrated Networks Sols., Inc.*, 609 F.3d 1308, 1318 (Fed. Cir. 2010), *and i4i Ltd. P’ship v. Microsoft Corp.*, 598 F.3d 831, 856–57 (Fed. Cir. 2010).

8.5 Jury Deliberations

Once the case is submitted to the jury for deliberations, there is little for the court or the parties to do except to reduce the hardship on the jury and make sure it has all the information it needs to make its decision.

8.5.1 Schedule of Deliberations

While the jury is deliberating, court is not in session. Therefore, the court should be open to modifying the daily schedule for deliberations to meet the needs of the jurors. There is no longer the need to maintain time outside the jury’s presence to resolve legal issues. Therefore, if the jurors agree, the court can allow full-day deliberations even when trial proceeded on a half-day schedule. The jurors, however, should be informed that they are under a continuing duty to serve, and the court should not adopt irregular schedules.

In multiphase trials, issues are usually phased to separate presentation of issues to prevent jury confusion. If the jury did not deliberate until all phases were con-

ducted, that would defeat much of the purpose of separating the proceedings. The jury should deliberate immediately after each phase of the trial.

8.5.2 Claim-Construction Considerations

Jury deliberations are restricted to issues of fact. Therefore, the court should make clear that the jury is not to make any determination regarding claim construction. *Markman v. Westview Instr., Inc.*, 52 F.3d 967, 976 (Fed. Cir. 1995), *aff'd*, 517 U.S. 370 (1996). Indeed, the parties cannot even argue claim-construction disputes to the jury. *Cytologix Corp. v. Ventana Med. Sys., Inc.*, 424 F.3d 1168, 1172 (Fed. Cir. 2005). Claim-construction arguments may confuse jurors and lead them to believe they should be making claim-construction determinations. The court should instruct the jury on the proper construction of claims and emphasize that it is bound by the court's construction. *Structural Rubber Prods. Co. v. Park Rubber*, 749 F.2d 707, 723 (Fed. Cir. 1984).

8.5.3 Jury Access to Evidence

During deliberations, the jurors may need additional information to arrive at a decision, whether it is exhibits, testimony, or further instructions on the law. All juror communications should be conducted through the courtroom deputy in writing, with requests passed on to the judge. Before acting on any request, the court should inform the parties and allow them to be present.

8.5.3.1 Exhibits and Demonstratives

As noted above, access to evidence admitted during trial can assist the jurors in their deliberations. A copy of the exhibits introduced at trial should be provided to the jurors in the jury room. Demonstratives, however, are not evidence. Therefore, the jurors should not be given access to them. Only demonstratives admitted into evidence as an exhibit during trial should be considered by the jurors during deliberations.

8.5.3.2 Testimony

As memories fade and disagreement may arise between jurors regarding a witness's testimony, jurors may sometimes request to have testimony read during deliberations. While allowing testimony to be read to the jury is in the court's discretion, the practice can be problematic and should not be exercised routinely. *See Dabney v. Montgomery Ward & Co., Inc.*, 761 F.2d 494, 499 (8th Cir. 1985); *Mayeaux v. Am. Mut. Liberty Ins. Corp.*, 409 F.2d 508, 509 (5th Cir. 1969).

Unlike exhibits, which are complete and available in their entirety for review, reading portions of testimony is incomplete and may give a skewed presentation of evidence. It becomes difficult to draw the line as to what testimony should be read to the jury. Jurors are often unable to articulate clearly what specific testimony they are

interested in, which can lead to requests for testimony on broad subject matters. Catering to such requests is neither practical nor helpful.

Testimony should be read to jurors only in circumstances when the jurors can identify the specific testimony in which they are interested to resolve a disagreement between the jurors. In such cases, the parties should be informed of the request and the court should consider counsels' request to have other portions of testimony read for fairness.

8.5.3.3 Juror Questions During Deliberations

Questions may arise during jury deliberations. The court should be wary of providing answers to requests for factual information and should only do so in the presence of and after consultation with the parties. Fact-finding is reserved for the jury, and neither the court nor the parties should usurp that role.

Courts are duty-bound to provide jurors with further legal instructions when requested to do so. The court should inform the parties of the question and give the parties an opportunity to jointly propose an appropriate instruction. It may be appropriate to give additional instructions or clarifying instructions to provide a full and fair response. Care should be taken, however, to avoid overinstructing and confusing the jury.

8.5.4 Verdict Forms

8.5.4.1 General Verdict Forms

Use of general verdict forms in patent cases is discouraged. The jury is charged with deciding several interrelated and complex issues. General verdict forms do not assist the jury in understanding the applicable law and maintaining consistency in its findings. A general verdict is inseparable; a single error completely destroys it. *Richardson-Vicks v. Upjohn Co.*, 122 F.3d 1476, 1485 (Fed. Cir. 1997). As a result, a significant amount of resources is spent reviewing decisions made by general verdict.

8.5.4.2 Special Verdict Forms and Special Interrogatories

The court can help guide the jury in proper application of the law and ensure consistency in its findings by using special verdict forms. Fed. R. Civ. P. 49(a). Special verdicts require a jury to make specific findings of fact from which the court applies the applicable law. Patent cases are particularly well suited for special verdicts. *Richardson-Vicks*, 122 F.3d at 1485, citing *Warner-Jenkinson Co. v. Hilton Davis Chem. Co.*, 520 U.S. 17, 39 (1997). For example, if the jury finds that an independent claim of a patent is not infringed, then it cannot find the dependent claims infringed. Use of a special verdict form allows the court to ensure consistency between findings on independent and dependent claims. A model sample verdict form for patent cases is now available as Appendix C.3 to the Model Patent Jury Instructions for the Northern District of California.

A court can also use a general verdict form with special interrogatories. Fed. R. Civ. P. 49(b). Use of special interrogatories differs from special verdicts only in that the jury, rather than the court, makes the ultimate decision when general verdicts with special interrogatories are used. There is still risk that the jury will make a decision inconsistent with its findings. In such cases, the federal rules permit the court to enter judgment consistent with the jury's findings notwithstanding the verdict. *Id.* Where the findings are inconsistent and do not support the verdict, the court can recall the jury for further consideration or order a new trial.

8.6 Bench Trials

A court may try a patent case without a jury where the parties have waived the right to a jury trial or when equitable issues have been bifurcated for the court's consideration. Waiver is rare. Most often, bench trials are held to try equitable defenses such as inequitable conduct, laches, and estoppel.

As the court is the fact finder in bench trials, there is less of a need for extensive judicial management. The court must make specific findings of facts and conclusions of law when rendering its decision. Fed. R. Civ. P. 52. It can, however, be less stringent with issues of admissibility and evidentiary objections as it is both the arbiter of those issues and the ultimate fact finder. There is less of a concern that the court will be prejudiced by certain evidence.

Chapter 9

Posttrial

- 9.1 Entry of Judgment 1
- 9.2 Posttrial Motions 2
 - 9.2.1 Permanent Injunctions 2
 - 9.2.1.1 Issuing a Permanent Injunction 2
 - 9.2.1.2 Ongoing Royalty After Denial of a Permanent Injunction 6
 - 9.2.1.3 Motion for Contempt 8
 - 9.2.2 Enhanced Damages 9
 - 9.2.2.1 Timing 9
 - 9.2.2.2 Standard 10
 - 9.2.3 Attorneys' Fees 11
 - 9.2.3.1 Timing 11
 - 9.2.3.2 Standard 11
 - 9.2.4 Motion for a New Trial 16
 - 9.2.5 Renewed Motion for Judgment as a Matter of Law 17
 - 9.2.6 Motion to Vacate Judgment in Connection with Settlement 18
- 9.3 Appeal 19
 - 9.3.1 Stay of Injunction Pending Appeal 19
 - 9.3.2 Remands 21

The court's duties do not cease after a verdict is rendered. Even following entry of judgment, the court is responsible for resolving posttrial motions and issues relating to appeal. This chapter examines the posttrial considerations that courts face in patent trials.

9.1 Entry of Judgment

In patent cases, as in every case, after a jury renders its verdict or after the court makes its decision, judgment must be entered. The federal rules require that every judgment be entered in a separate document to make clear when the time to file posttrial motions and appeal begins to run. Fed. R. Civ. P. 58. The clerk may enter judgment when a jury returns a general verdict. Where special verdicts are used, the court, not the clerk, must enter the judgment.

The court has some flexibility in the timing for entry of judgment. One option is to enter judgment in accordance with the jury's verdict soon after the verdict is rendered. While the verdict may be altered by resolution of posttrial motions, the court's ruling on the posttrial motions need not be entered in a separate document. Fed. R. Civ. P. 58(a)(1)–(4). Therefore, early entry of judgment leads to quicker resolution of posttrial motions, without the need for the court to enter a second judgment and therefore without creating additional administrative duties for the court.

In cases of willful infringement, however, the patent owner will likely move for enhanced damages. Judgment entered on the verdict will need to be amended in a separate document, should the court decide to increase damages. In such cases, it may be more efficient to set a briefing schedule with the parties for posttrial motions, as well as motions for enhanced damages, prejudgment interest, and attorneys' fees. Once all motions are resolved, the court can then enter one judgment that reflects

the verdict and the rulings on posttrial motions. *Larez v. Los Angeles*, 946 F.2d 630, 636 (9th Cir. 1991) (noting that nothing in the Federal Rules prohibits filing posttrial motions before entry of judgment); *Dunn v. Truck World, Inc.*, 929 F.2d 311, 313 (7th Cir. 1991) (same).

9.2 Posttrial Motions

In patent cases, as in most cases, trial is usually followed by a series of posttrial motions. Where there is a finding of infringement, patent owners almost always seek a permanent injunction. In cases of willful infringement, the patent owner will also typically move for enhanced damages. Because the patent statute authorizes the award of attorneys' fees in exceptional cases, posttrial motions often seek attorneys' fees. In addition, parties will likely bring motions for judgment as a matter of law and/or new trial motions on the liability issues. In this section, we discuss the particular considerations that arise in conjunction with these posttrial motions in patent cases.

9.2.1 Permanent Injunctions

In addition to monetary relief, many patentees seek entry of a permanent injunction after a finding of infringement. See § 283 (“[A court] may grant injunctions in accordance with the principles of equity to prevent the violation of any right secured by patent, on such terms as the court deems reasonable.”). Historically, courts entered injunctions as a matter of course following an infringement finding. Following the Supreme Court’s decision in *eBay Inc. v. MercExchange, L.L.C.*, 547 U.S. 388, 391–92 (2006), however, an injunction may be issued only if the patent holder satisfies a four-factor injunction test.

9.2.1.1 Issuing a Permanent Injunction

In *eBay*, the Supreme Court stated that to obtain an injunction a party “must demonstrate: (1) that it has suffered an irreparable injury; (2) that remedies available at law, such as monetary damages, are inadequate to compensate for that injury; (3) that, considering the balance of hardships between the plaintiff and defendant, a remedy in equity is warranted; and (4) that the public interest would not be disserved by a permanent injunction.” *Id.* at 391. Subsequently, the Federal Circuit held that *eBay* eliminates any presumption of irreparable injury to a patent holder after a judgment of infringement and no invalidity. *Robert Bosch LLC v. Pylon Mfg. Corp.*, 659 F.3d 1142, 1149 (2011). The Federal Circuit also has also held that there must be a “causal nexus” between any such irreparable injury and patent infringement. *Apple Inc. v. Samsung Elecs. Co. (Apple III)*, 735 F.3d 1352, 1360 (Fed. Cir. 2013). In a case in which the harm stems from lost sales to a competitor’s infringement, this requires proof that “the patented features impact consumers’ decisions to purchase the accused devices” even if they are not “the exclusive or predominant reason why consumers bought . . . [the infringing] products.” *Apple Inc. v. Samsung Elecs. Co.*, 801

F.3d 1352, 1360 (Fed. Cir. 2015). Additionally, the Federal Circuit has noted that, “[a]lthough injunctions are tools for prospective relief designed to alleviate future harm, by its terms the first *eBay* factor looks, in part, at what has already occurred.” *i4i Ltd. P’ship v. Microsoft Corp.*, 598 F.3d 831, 862 (2010), *aff’d on other grounds*, 131 S. Ct. 2238 (2011). “Past harm to a patentee’s market share, revenues, and brand recognition is relevant for determining whether the patentee ‘has suffered an irreparable injury.’” *Id.* at 861 (quoting *eBay*, 547 U.S. at 391; emphasis in original). *But see Monsanto Co. v. Geertson Seed Farms*, 561 U.S. 139, 142 (2010) (explaining that an injunction was not warranted under the *eBay* test because, “[m]ost importantly, respondents cannot show that they will suffer irreparable injury” (emphasis added)).

Although *eBay* generally forbids “broad classifications” of cases for purposes of determining when an injunction is proper or improper, *id.* at 393, courts have shown tendencies to grant or deny motions for permanent injunctions in certain types of situations. Courts often find the *eBay* test satisfied and issue an injunction in cases between direct or indirect competitors, or where, as a result of an infringing feature, the infringer’s product supplants the market for the patent holder’s product. *See Broadcom Corp. v. Emulex Corp.*, 732 F.3d 1325, 1338 (Fed. Cir. 2013); *Presidio Components, Inc. v. Am. Tech. Ceramics Corp.*, 702 F.3d 1351, 1363 (Fed. Cir. 2012); *Edwards Lifesciences AG v. CoreValve, Inc.*, 699 F.3d 1305, 1315 (Fed. Cir. 2012) (“Courts awarding permanent injunctions typically do so under circumstances where plaintiff practices its invention and is a direct market competitor”), quoting *Advanced Cardiovascular Sys. v. Medtronic Vascular, Inc.*, 579 F. Supp. 2d 554 (D. Del. 2008); *Robert Bosch LLC v. Pylon Mfg. Corp.*, 659 F.3d 1142, 1156–57 (Fed. Cir. 2011); *i4i Ltd. P’ship v. Microsoft Corp.*, 598 F.3d 831, 861–63 (Fed. Cir. 2010), *aff’d on other grounds*, 131 S. Ct. 2238 (2011); *Acumed LLC v. Stryker Corp.*, 551 F.3d 1323, 1328–29 (Fed. Cir. 2008); *Broadcom Corp. v. Qualcomm Inc.*, 543 F.3d 683, 702–03 (Fed. Cir. 2008); *Verizon Servs. Corp. v. Vonage Holdings Corp.*, 503 F.3d 1295, 1310–11 (2007). Even if the patent owner does not practice the patent, but sells a competing product, an injunction against a competitor may be proper. *Presidio Components*, 702 F.3d at 1363. Additionally, an injunction against a competitor may be proper even when the patent holder previously licensed the patent to another competitor or its customer, when other unlicensed competitors employ the patent, or when the patented product is not core to the patent holder’s business or the injunction may put an infringer out of business. *Robert Bosch LLC*, 659 F.3d at 1150–1152 (additional infringing competitors; noncore nature; small competitor potentially put out of business); *Acumed*, 551 F.3d at 1328–29 (competitor); *Broadcom Corp. v. Qualcomm Inc.*, 543 F.3d at 703 (although patent licensed to customer, injunction issued that infringing party argued could preclude it from continuing in relevant business) (citing *Windsurfing Int’l, Inc. v. AMF, Inc.*, 782 F.2d 995, 1003 n. 12 (Fed. Cir. 1986) (“One who elects to build a business on a product found to infringe cannot be heard to complain if an injunction against continuing infringement destroys the business so elected”)). In some cases, to ameliorate hardship on the infringer, the court will include a “sunset provision” that allows continued sales of the infringing product pursuant to a royalty to allow the infringer time to eliminate the disputed features from its product. *See, e.g., Broadcom Corp. v. Qualcomm Inc.*, 543 F.3d 683,

704 (Fed. Cir. 2008) (injunction allowing continued sales by infringer for twenty months). The broad use of injunctions in these competitive cases, when properly supported by other factors, stems from the fundamental nature of patents as a grant to the owner of the right to exclude. *Id.* at 1338; *Robert Bosch*, 659 F.3d at 1149–50.

Following *eBay*, courts have denied permanent injunctions in cases where the patentee merely licensed its technology and did not offer its own commercial embodiment, where only the patentee's licensee competes with an infringer, where the scope of the requested injunction was overly broad, or where an injunction created important public health concerns. See, e.g., *ActiveVideo Networks v. Verizon Commc'ns*, 694 F.3d 1312, 1337–41 (Fed. Cir. 2012) (no irreparable harm or inadequate legal remedy based on licensee's competition with infringer); *Bard Peripheral Vascular, Inc. v. W.L. Gore & Assocs.*, 670 F.3d 1171 (Fed. Cir. 2012), *on reh'g*, 682 F.3d 1003 (Fed. Cir. 2012) (injunction would preclude use of important medical devices); *Voda v. Cordis Corp.*, 2006 U.S. Dist. LEXIS 63623, 2006 WL 5347777 (W.D. Okla. Sept. 5, 2006), *aff'd*, 476 F.3d 887 (Fed. Cir. 2007) (licensor of technology); *Praxair, Inc. v. ATMI, Inc.*, 479 F. Supp. 2d 440, 442–44 (D. Del. 2007) (proposed injunction required defendant to recall products already sold to third parties); *z4 Techs., Inc. v. Microsoft Corp.*, 434 F. Supp. 2d 437, 440–41 (E.D. Tex. 2006) (licensor of technology). Also, the Federal Circuit has stated that where the jury's damages award includes monetary compensation for future infringing sales, a patent holder cannot show irreparable harm and is, therefore, not entitled to an injunction. *In-nogenetics, N.V. v. Abbott Labs.*, 512 F.3d 1363, 1380 (Fed. Cir. 2008).

In connection with standard-setting proceedings and otherwise, patent owners sometimes commit to provide a fair, reasonable and nondiscriminatory (“FRAND”) license to any potential licensee. While there is no per se rule precluding an injunction to such a patent owner, an injunction is unlikely. Establishing irreparable harm is difficult, and allowing the use of a standard resulting from a FRAND commitment better serves public interest. See *Apple Inc. v. Motorola, Inc.*, 757 F.3d 1286, 1331–32 (Fed. Cir. 2014) (noting that absent unusual circumstances, such as an infringer refusing a FRAND royalty or unreasonably delaying negotiations, it will be difficult for a patent owner subject to a FRAND commitment to establish irreparable harm or that damages are not an adequate remedy; and that even when an infringer has refused to accept any license offer, that does not necessarily justify injunctive relief).

Table 9.1 summarizes how courts have applied common fact patterns presented in cases to the four-factor test for issuing permanent injunctions.

Table 9.1
Permanent Injunction Considerations (*eBay* Factors)

Irreparable Harm	
(In situations in which the relevant patent(s) encompass only one or some features of a multifeature product, the factor is applicable only to those infringing feature(s) with a sufficiently close causal nexus to the harm (see § 3.2.2.2.4))	
Facts Tending to Establish Irreparable Harm	Facts Weighing Against Irreparable Harm
<ul style="list-style-type: none"> • Infringer is competitor • Loss of market share owing to infringement by competitor • Price erosion due to direct competition by infringer • Harm to goodwill, brand recognition, or reputation as innovator because of presence of infringer in the market • Customers are unlikely to switch in the future, and therefore infringement causes long-term loss • Patent holder's decision not to license or attempt to license patent to the infringer • Economic harm suffered by licensees of research institutes and universities; adverse effect on institution's ability to license intellectual property to finance further research and development • Economic harm to licensor by competitor even though licensor did not practice the invention 	<ul style="list-style-type: none"> • Loss of licensing revenue by a patent holder that does not compete with infringer or practice the invention • Award of money damages to patent holder that includes compensation based on future sales of infringing product • Harm to licensees • The patent holder agreed to provide FRAND licenses
Inadequate Remedy at Law	
Facts Tending to Establish Inadequate Remedy at Law	Facts Weighing Against Inadequate Remedy at Law
<ul style="list-style-type: none"> • Loss of market share, harm to reputation, price erosion • Infringer's inability to pay damages, including lack of U.S. assets with which to satisfy judgment for money damages • Patent holder's refusal to grant license, or willingness to grant license only in exceptional circumstances, and its engagement in lengthy litigation to protect that business decision 	<ul style="list-style-type: none"> • Loss of bargaining leverage by patent holder that does not practice the invention • Patent holder's willingness to license the patent to the infringer • Patent holder's policy to license the patent to others in circumstances similar to the infringer, or to obtain maximum monetary returns • Patent holder's ability to pay damages award is irrelevant (unlike its <i>inability</i> to pay)

Balance of Hardships	
Facts Tending to Establish Balance of Hardships Favoring Injunction	Facts Weighing Against Balance of Hardships Favoring Injunction
<ul style="list-style-type: none"> • Infringing product is but one of many products offered by infringer • Parties' relative size • Infringer's ability to offer a design-around • Where infringer is direct competitor, loss of right to exclude is a greater hardship than loss to infringer from interruption or even cessation of its business • Court establishes adequate time for work-around before injunction effective • Injunction not applicable to infringer's customers who purchased before injunction's effective date • Providing a provision in the injunction delaying its effective date to allow infringer to modify its product 	<ul style="list-style-type: none"> • Patented feature is but a small component of the infringing product • Harm to infringer that practices invention is greater than harm to licensing business of nonpracticing patent holder • Consequences and costs to infringer of ceasing sales of infringing product or creating design-around, except little weight if business built primarily on infringing product
Public Interest	
Facts Tending to Establish Public Interest Favoring Injunction	Facts Weighing Against Public Interest Favoring Injunction
<ul style="list-style-type: none"> • Public interest served by enforcement of patents 	<ul style="list-style-type: none"> • Lower prices for public access to pharmaceuticals not sufficient • Harm failing to rise to level of adverse public health consequences not sufficient • Precluding access to a large number of desired, noninfringing features

9.2.1.2 Ongoing Royalty After Denial of a Permanent Injunction

Consideration of the four permanent injunction factors articulated in *eBay* does not always end the inquiry. Where a court determines that a permanent injunction is not warranted, it might determine an appropriate ongoing royalty for the infringer's continued use of the patented invention (unless the jury explicitly awarded damages for future infringement).

In setting an ongoing royalty in lieu of a permanent injunction, the district court is first "encouraged[] to allow the parties to negotiate a license." *Telcordia Techs., Inv. v. Cisco Sys.*, 612 F.3d 1365, 1378 (Fed. Cir. 2010); *see also Paice LLC v. Toyota Motor Corp.*, 504 F.3d 1293, 1315 n.15 (Fed. Cir. 2007). In the event the parties are unable to reach an agreement, the court may impose an ongoing royalty. *Telcordia Techs.*, 612 F.3d at 1379; *Paice*, 504 F.3d at 1315. There is no Seventh Amendment right to have a jury determine the issue of an ongoing royalty. *Paice*, 504 F.3d at 1316. Indeed, even the jury's determination of a reasonable royalty does not bind the

court in setting an ongoing royalty. *Amado v. Microsoft Corp.*, 517 F.3d 1353, 1361–62 (Fed. Cir. 2008). This is because, as the Federal Circuit has recognized, there is a difference between a reasonable royalty for pre-verdict infringement and damages for postverdict infringement, given the change in the parties’ legal relationship and other economic factors. *Id.* Where the jury’s royalty damages award is a lump sum that includes a royalty for future sales, however, the court should not provide an ongoing royalty; the jury’s royalty determination precludes any further award. *Summit 6, LLC v. Samsung Elecs. Co.*, 802 F.3d 1283, 1300–01 (Fed. Cir. 2015). In any event, the court should provide a reasoned explanation for any ongoing royalty it imposes. In particular, the court may take additional evidence into account for any additional economic factors relevant to establishing a royalty for ongoing use of the patented invention postverdict. *Paice*, 504 F.3d at 1315.

In determining the amount of an ongoing royalty, the Federal Circuit has indicated that a district court should consider

the change in the parties’ bargaining positions, and the resulting change in economic circumstances, resulting from the determination of liability—for example, the infringer’s likelihood of success on appeal, the infringer’s ability to immediately comply with the injunction, . . . etc.—as well as the evidence and arguments found material to the granting of the injunction and the stay.

Amado, 517 F.3d at 1362. Some district courts determining ongoing royalties under this standard have used the *Georgia-Pacific* factors, see § 14.4.3.2.1.4, but modified the usual factors to assume that the hypothetical negotiation occurred after the determination of the patent’s validity and infringement, when the infringer must consider the possibility that the patent holder could force it off the market absent a license. See, e.g., *Boston Sci. Corp. v. Johnson & Johnson*, 2009 U.S. Dist. LEXIS 35372, at *7, 2009 WL 975424 (N.D. Cal. Apr. 19, 2009); but see *Amado v. Microsoft Corp.*, 2008 U.S. Dist. LEXIS 110152, at *32–33, 2008 WL 8641264 (C.D. Cal. Dec. 4, 2008) (“By not including any reference to the *Georgia-Pacific* factors [in *Amado*, 517 F.3d at 1362], the Federal Circuit implicitly rejected this approach.”). In doing so, some courts have noted that, since the pre-verdict analysis assumed the patent’s validity and infringement, this change will not alter the prejudgment running royalty set by the verdict. See, e.g., *Presidio Components, Inc. v. Am. Tech. Ceramics Corp.*, 2010 U.S. Dist. LEXIS 79039, at *16–17, 2010 WL 3070370 (S.D. Cal. Aug. 5, 2010); *Ariba, Inc. v. Emptoris, Inc.*, 567 F. Supp. 2d 914, 918 (E.D. Tex. 2008); *Orion IP, LLC v. Mercedes-Benz USA, LLC*, 2008 U.S. Dist. LEXIS 108683, at *9, 2008 WL 8856865 (E.D. Tex. Mar. 28, 2008). Other courts, relying on the Federal Circuit’s citation of the “change in the parties’ bargaining positions, and the resulting change in economic circumstances, resulting from the determination of liability” (*Amado*, 517 F.3d at 1353), have believed that the hypothetical negotiation should reflect a negative posttrial impact on the infringer’s position. See, e.g., *Boston Sci. Corp.*, 2009 U.S. Dist. LEXIS 35372 at *16; *Joyal Prods. v. Johnson Elec. North Am., Inc.*, 2009 U.S. Dist. LEXIS 15531, *39–40, 2009 WL 512156 (D.N.J. Feb. 26, 2009); *Creative Internet Advert. Corp. v. Yahoo! Inc.*, 674 F. Supp. 2d 847, 861 (E.D. Tex. 2009). Also, some district courts have suggested that the rate of the ongoing royalty should be increased because posttrial the infringement is “willful.” However, the Federal Circuit

has indicated in the analogous circumstance of determining a royalty for the period when an injunction is stayed pending appeal that “willfulness, as such, is not the inquiry when the infringement is permitted by a court-ordered stay.” *Amado*, 517 F.3d at 1362. Finally, while recognizing that the ultimate determination of the ongoing royalty is a legal issue to be determined by the court, some courts nevertheless submit the question to the jury for an advisory verdict, citing the efficiency of doing so. See, e.g., *Cummins-Allison Corp. v. SBM Co., Ltd.*, 669 F. Supp. 2d 774, 778 (E.D. Tex. 2009); *Amgen, Inc. v. F. Hoffmann–La Roche Ltd.*, 581 F. Supp. 2d 160, 210 n.12 (D. Mass. 2008), *vacated in part on other grounds*, 580 F.3d 1340 (Fed. Cir. 2009)

9.2.1.3 Motion for Contempt

Following entry of a permanent injunction, an infringing party often will modify the product or process found to infringe to design around the patent, and begin marketing the modified product. If the patent owner believes that the redesigned product infringes, it can challenge the design-around by commencing a second patent-infringement action. In limited circumstances, the patent owner alternatively can seek to have an enjoined party held in civil contempt for violating the injunction.

To prove contempt, the patent owner must provide clear and convincing evidence both that the newly accused product is not more than colorably different from the product found to infringe and that the newly accused product actually infringes. *TiVo Inc. v. EchoStar Corp.*, 646 F.3d 869, 882 (Fed. Cir. 2011) (en banc). To resolve this first, and “primary,” element, the court must determine “whether the newly accused product is so different from the product previously found to infringe that it raises ‘a fair ground of doubt as to the wrongfulness of the defendant’s conduct.’” *Id.* at 882, quoting *Cal. Artificial Stone Paving Co. v. Molitor*, 113 U.S. 609, 618 (1885). In making this determination, the court should focus on “those aspects of the accused product that were . . . a basis for the prior finding of infringement, and the modified features of the newly accused product.” If an element previously found to infringe has been modified or removed, the court should determine whether that modification is significant. *Id.*; see also *Proveris Sci. Corp. v. Innovasystems, Inc.*, 739 F.3d 1367, 1370–71 (Fed. Cir. 2014). Usually, if the change is nonobvious, it should be found to be a significant difference. *TiVo*, 646 F.3d at 883. If the product’s modification does render it more than colorably different, whether or not it still infringes the patent, there is no contempt; instead, infringement must be proven in a new jury trial. *Id.*

The test’s second, independent element is that the accused product still infringes. In making this assessment, the court should determine that each element of a claim is infringed using any claim constructions decided during the liability case. *Id.* at 883. It, however, must construe any additional claims necessary to determine the infringement issue. *Id.* at 883; *Proveris Sci. Corp.*, 739 F.3d at 1372. Finally, the court must determine whether there is clear and convincing evidence that the specific provisions of the injunction were violated. In making this determination, the injunction must be construed narrowly, with any ambiguity resolved against the patent owner.

Abbott Labs. v. Torpharm, Inc., 503 F.3d 1372, 1382–83 (Fed. Cir. 2007). The propriety of the injunction or its specific provisions, however, is not subject to challenge during the contempt proceeding. See *TiVo*, 646 F.3d at 886.

In assessing the appropriate penalty for contempt, the court has wide discretion. In exercising this discretion, it may consider the infringer’s “diligence and good faith efforts” to create a noninfringing product. While neither diligence nor good faith is a defense to contempt, these factors are relevant to the appropriate penalty. *TiVo*, 646 F.3d at 800.

As part of or following a contempt proceeding, the court may be asked to modify its injunction to assure that similar future infringement does not take place by adding a provision requiring that any subsequent claimed design-around be submitted to the patent holder or the court before public distribution. Such an order is allowed if the court determines that it is reasonably necessary to obtain compliance with the prior injunction. See *Additive Controls & Measurement Sys., Inc. v. Flowdata, Inc.*, 154 F.3d 1345, 1356 (Fed. Cir. 1998) (“Although such broad injunctions should be used only in exceptional cases, the district court reasonably concluded that such measures were necessary in this case to compel compliance with the court’s orders”).

9.2.2 Enhanced Damages

The patent statute authorizes a court to increase a damages award up to three times. § 284. The statute “contains no explicit limit or condition” as to when damages can be increased. The Supreme Court explained, however, that increased damages only should be awarded for “egregious cases of misconduct beyond typical infringement,” such as “cases typified by willful conduct,” or “deliberate or wanton” infringement. *Halo Electronics, Inc. v. Pulse Electronics, Inc.*, No. 14-1513, slip op. at 9–11, 15 (Supreme Court, June 3, 2016). Under this test, “intentional or knowing [infringement] may warrant enhanced damages.” *Id.* at 10. Willful infringement must be proven by a preponderance of evidence (*id.* at 12) and usually is based the infringer’s knowledge and conduct at the time of infringement, not, for example, the merit of arguments later asserted in litigation (*id.* at 10). Even following a finding of egregious misconduct or other circumstances that may merit an award of enhanced damages, any award of such damages, including the amount of any enhancement, remains fully in the sound discretion of the court based on the particular circumstances of the case. *Id.* at 11.

Absent other circumstances, increased damages should not be awarded to further compensate the patent holder. *Id.* at 3–4. And, because of § 298, “failure of an infringer to obtain advice of counsel . . . may not be used to prove that the accused infringer willfully infringed.”

9.2.2.1 Timing

Naturally, damages can be increased only after damages and willfulness have been determined. Courts can be inundated with various motions after a verdict is

returned. Therefore, the court should set a briefing schedule for a motion for enhanced damages, as well as posttrial motions, following the jury's verdict.

A motion for enhanced damages can be brought before or after entry of judgment. If brought after entry of judgment, the court should amend the judgment to reflect any increased damages. It is often more manageable to consider an enhanced damages motion at the same time as posttrial motions. The court's ruling on posttrial motions can affect the amount of enhancement. In addition, ruling on all the motions together allows the court to enter a single judgment reflecting all its rulings.

9.2.2.2 Standard

The decision of whether to enhance damages is based on the egregiousness of the infringer's conduct in light of the totality of the circumstances. *Jurgens v. CBK, Ltd.*, 80 F.3d 1566, 1570 (Fed. Cir. 1996); *Read Corp. v. Portec, Inc.*, 970 F.2d 816, 826 (Fed. Cir. 1992). Prior to its decision in *In re Seagate Tech., LLC*, 497 F.3d 1360 (Fed. Cir. 2007) (en banc), the Federal Circuit articulated nine factors to consider when evaluating the degree of the infringer's culpability and deciding whether to increase damages:

- (1) whether the infringer deliberately copied the ideas or design of another
- (2) whether the infringer, when he knew of the other's patent protection investigated the scope of the patent and formed a good-faith belief that it was invalid or that it was not infringed
- (3) the infringer's behavior as a party to the litigation
- (4) the defendant's size and financial condition
- (5) the closeness of the case
- (6) the duration of defendant's misconduct
- (7) remedial action by the defendant
- (8) the defendant's motivation for harm
- (9) whether the defendant attempted to conceal its misconduct

Read Corp., 970 F.2d at 827. Following *Seagate*, the Federal Circuit confirmed that these factors are appropriate to determine enhancement, noting that "[t]he [*Seagate*] test for willfulness is distinct and separate from the [*Read*] factors guiding a district court's discretion regarding enhanced damages." *i4i Ltd. P'ship*, 598 F.3d at 859; see also *Funai Elec. Co., Ltd. v. Daewoo Elecs. Corp.*, 616 F.3d 1357, 1376 (Fed. Cir. 2010). In particular, it is still appropriate to consider that the infringer timely obtained and relied on an opinion of counsel that the patent is not infringed or invalid. See *Aspex Eyewear, Inc. v. Clariti Eyewear, Inc.*, 605 F.3d 1305, 1313 (Fed. Cir. 2010); *Finisar Corp. v. DirecTV Grp., Inc.*, 523 F.3d 1323, 1339 (Fed. Cir. 2008). For patents issued on or after September 16, 2012, however, it is improper to consider that the infringer did *not* obtain such an opinion, or that the infringer did not present the opinion at trial. § 298 ("The failure of an infringer to obtain the advice of counsel with respect to any allegedly infringed patent, or the failure of the infringer to pre-

sent such advice to the court or jury, may not be used to prove that the accused infringer willfully infringed the patent . . . ”).

The court may also consider the size of the damages award in ruling on enhancement. *Riles v. Shell Expl. & Prod. Co.*, 298 F.3d 1302, 1314 (Fed. Cir. 2002). While the court is not required to enhance damages, it must state its reasons for not doing so. *Tate Access Floors, Inc. v. Maxcess Techs., Inc.*, 222 F.3d 958, 972 (Fed. Cir. 2000); *Jurgens*, 80 F.3d at 1572.

Not only does the court have discretion in determining whether to enhance damages, but it also has discretion with respect to the amount of enhancement. *SRI Int’l v. Advanced Tech. Labs., Inc.*, 127 F.3d 1462, 1468–69 (Fed. Cir. 1997) (citing *Nat’l Presto Indus. Inc. v. W. Bend Co.*, 76 F.3d 1185, 1193–94 (Fed. Cir. 1996)); *Amsted Indus., Inc. v. Buckeye Steel Castings Co.*, 24 F.3d 178, 183 (Fed. Cir. 1994). While it is common to double or triple the damages amount, courts can use a wide range of multipliers in setting the amount of enhancement, including using a non-integer or percentage calculation. *Advanced Cardiovascular Sys., Inc. v. Medtronic, Inc.*, 265 F.3d 1294, 1310–11 (Fed. Cir. 2001) (affirming 30% enhancement); *Va. Panel Corp. v. MAC Panel Co.*, 133 F.3d 860, 866–67 (Fed. Cir. 1997) (affirming 10% enhancement).

9.2.3 Attorneys’ Fees

The patent statute also authorizes the award of reasonable attorneys’ fees in exceptional cases. § 285. The purpose is to give the court the power to shift the burden of unnecessary and vexatious litigation onto the party responsible for it. Even in exceptional cases, however, an award of attorneys’ fees is not automatic. *Nat’l Presto*, 76 F.3d at 1197. Like enhanced damages, the award of attorneys’ fees lies in the trial court’s discretion. *Modine Mfg. Co. v. Allen Grp., Inc.*, 917 F.2d 538, 543 (Fed. Cir. 1990). An award of fees for violation of Rule 11 instead of, or in addition to, an award pursuant to § 285 is also possible.

9.2.3.1 Timing

Attorneys’ fees motions can be brought before or after entry of judgment, but no later than fourteen days after entry of judgment. Fed. R. Civ. P. 54(d)(2)(B). Unlike enhanced damages, separate judgment does not have to be entered upon postjudgment disposition of a motion for attorneys’ fees. Fed. R. Civ. P. 58(a)(1)(C). When brought by a patent holder, however, a motion for attorneys’ fees usually is brought together with a request for enhanced damages, as the same facts usually support both motions. The court should set a briefing schedule for these motions as well as posttrial motions. Again, it is advisable where issues overlap to consider attorneys’ fees and enhanced damages motions at the same time as posttrial motions.

9.2.3.2 Standard

Attorneys’ fees may be awarded by the court to the “prevailing party” in cases it finds “exceptional.” § 285. Rejecting previous Federal Circuit law defining this

standard, the Supreme Court in *Octane Fitness, LLC v. Icon Health & Fitness, Inc.*, 134 S. Ct. 1749 (2014), held that “an ‘exceptional’ case is simply one that stands out from others with respect to the substantive strength of a party’s litigating position (considering both the governing law and the facts of the case) or the unreasonable manner in which the case was litigated.” *Id.* at 1756. The court should make this determination in its discretion based on the “totality of the circumstances.” *Id.* In making this assessment, it may consider, as a “‘nonexclusive’ list of ‘factors’”: “frivolousness, motivation, objective unreasonableness (both in the factual and legal components of the case) and the need in particular circumstances to advance considerations of compensation and deterrence” as well as “either subjective bad faith or exceptionally meritless claims.” *Id.* at 1756 n. 6, 1757, quoting *Fogerty v. Fantasy, Inc.*, 510 U.S. 517, 534 (1994) (describing appropriate considerations for the fee provision in the Copyright Act). The district court also has discretion to decline to award fees even in exceptional cases. See *Octane Fitness, LLC v. Icon Health & Fitness, Inc.*, 576 F. App’x 1002 (Fed. Cir. Aug. 26, 2014) (nonprecedential); *Gardco Mfg., Inc. v. Herst Lighting Co.*, 820 F.2d 1209, 1215 (Fed. Cir. 1987); *S.C. Johnson & Son, Inc. v. Carter-Wallace, Inc.*, 781 F.2d 198, 201 (Fed. Cir. 1986). The district court should, however, set forth its reasons for declining to award fees despite the finding of litigation misconduct and exceptional case status. See *Oplus Techs., Ltd. v. Vizio, Inc.*, 782 F.3d 1371, 1375–76 (Fed. Cir. 2015) (stating “when, as here, a court finds litigation misconduct and that a case is exceptional, the court must articulate the reasons for its fee decision”). All aspects of the district court’s determination are reviewed under an abuse-of-discretion standard—a standard that permits “an appellate court’s correction of a district court’s legal or factual error,” but not for mere disagreement with the district court’s judgment. *Highmark Inc. v. Allcare Health Mgmt. Sys., Inc.*, 134 S. Ct. 1744, 1748–49 & n.2 (2014).

Since *Octane Fitness*, the Federal Circuit affirmed a fees award when the patentee’s allegation of infringement was ill-supported, particularly in light of communications from the alleged infringer explaining its product and the parties’ proposed claim constructions, *Lumen View Tech. LLC v. Findthebest.com, Inc.*, 2016 U.S. App. LEXIS 1087 (Fed. Cir. Jan. 22, 2016), and the patentee could not provide credible evidence of infringement in response to a summary judgment motion. *Homeland Housewares, LLC v. Sorensen Research & Dev. Tr.*, 581 F. App’x 877 (Fed. Cir. 2014). Table 9.2 summarizes the factors district courts have considered when awarding fees in light of *Octane Fitness*.

Table 9.2
Facts Considered When Awarding Fees Under § 285

Factors Considered in Awarding Fees to Alleged Infringer	Factors Considered in Awarding Fees to Patent Holder
Objectively baseless or unreasonable infringement claims, including (e.g., <i>Bayer Cropscience AG v. Dow Agrosciences LLC</i> , No. 12-256, 2015 U.S. Dist. LEXIS 30752,	<ul style="list-style-type: none"> Objectively baseless or unreasonable invalidity or noninfringement arguments (e.g., <i>Romag Fasteners, Inc. v. Fossil, Inc.</i>, No. 10-cv-1827, 2014 U.S.

Factors Considered in Awarding Fees to Alleged Infringer	Factors Considered in Awarding Fees to Patent Holder
<p>2015 WL 1197436 (D. Del. Mar. 13, 2015); <i>IPVX Patent Holdings, Inc. v. Voxernet LLC</i>, No. 13-cv-1708, 2014 U.S. Dist. LEXIS 158037, 2014 WL 5795545 (N.D. Cal. Nov. 6, 2014)):</p> <ul style="list-style-type: none"> • Lack of evidentiary support for claims (e.g., <i>Medtrica Sols. Ltd. v. Cygnus Med. LLC</i>, No. 12-cv-538 (W.D. Wash. July 11, 2014)) • Knowledge that not all method steps were performed in the U.S. (e.g., <i>Home Gambling Network Inc. v. Piche</i>, No. 05-cv-610, 2014 U.S. Dist. LEXIS 71071, 2014 WL 2170600 (D. Nev. May 21, 2014)) • Lack of or inadequate prefiling investigation (e.g., <i>UltimatePointer, LLC v. Nintendo Co. Ltd.</i>, No. 14-cv-00865, 2015 U.S. Dist. LEXIS 83625, 2015 WL 3822577 (W.D. Wash. Mar. 9, 2015)) • Alleged infringer was licensed (e.g., <i>Summit Data Sys., LLC v. EMC Corp.</i>, No. 10-749, 2014 U.S. Dist. LEXIS 138248, 2014 WL 4955689 (D. Del. Sept. 25, 2014)) • Filing suit on expired patent combined with failure to mark (e.g., <i>Universal El-ecs., Inc. v. Universal Remote Control, Inc.</i>, No. 12-cv-329, 2015 U.S. Dist. LEXIS 91403 (C.D. Cal. Mar. 10, 2015)) • Finding of inequitable conduct (e.g., <i>Intellect Wireless, Inc. v. HTC Corp.</i>, No. 09-C-2495, 2015 U.S. Dist. LEXIS 2864, 2015 WL 136142 (N.D. Ill. Jan. 8, 2015)) <p>Litigation misconduct, including:</p> <ul style="list-style-type: none"> • Propounding overbroad and burdensome discovery (e.g., <i>Cambrian Science Corp. v. Cox Commc'ns Inc.</i>, No. 11-cv-01011, 2015 U.S. Dist. LEXIS 4415, 2015 WL 178417 (C.D. Cal. Jan. 6, 2015)) • Failure to provide discovery or proving false information (e.g., <i>Digital Reg of Tex., LLC v. Adobe Sys., Inc.</i>, No. 12-1971, 2015 U.S. Dist. LEXIS 29328, 2015 WL 1026226 (N.D. Cal. Mar. 9, 2015)) 	<p>Dist. LEXIS 113061, 2014 WL 4073204 (D. Conn. Aug. 14, 2014))</p> <ul style="list-style-type: none"> • Flawed, nonsensical expert reports and relitigating rejected claim construction (e.g., <i>Intex Recreation Corp. v. Team Worldwide Corp.</i>, No. 04-cv-01785, 2015 U.S. Dist. LEXIS 2847, 2015 WL 135532 (D.D.C. Jan. 9, 2015)) • Finding of willful infringement (<i>Comaper Corp. v. Antec, Inc.</i>, No. 5-cv-1103 (E.D. Pa. July 14, 2014)) <p>Litigation misconduct, including:</p> <ul style="list-style-type: none"> • Failure to provide discovery or false discovery responses (e.g., <i>Integrated Tech. Corp. v. Rudolph Tech., Inc.</i>, No. 06-cv-2182 (D. Ariz. Aug. 8, 2014)) • Baseless motion practice (e.g., <i>Cognex Corp. v. Microscan Sys., Inc.</i>, No. 13-CV-2027, 2014 U.S. Dist. LEXIS 91203, 2014 WL 2989975 (S.D.N.Y. June 30, 2014)) • Disregard of deadlines and case-management order (<i>Ultimate Combustion Co., Inc. v. Fuecotech, Inc.</i>, No. 12-cv-60545 (S.D. Fla. June 24, 2014))

Factors Considered in Awarding Fees to Alleged Infringer	Factors Considered in Awarding Fees to Patent Holder
<ul style="list-style-type: none"> • Baseless motion practice (e.g., <i>Wave Loch, Inc. v. Am. Wave Machs., Inc.</i>, No. 08-cv-00928 (S.D. Cal. Jan. 26, 2015)). • Baseless or shifting claim-construction positions (e.g., <i>Pure Fishing, Inc. v. Normack Corp.</i>, 10-cv-2140, 2014 U.S. Dist. LEXIS 153272, 2014 WL 5474589 (D.S.C. Oct. 28, 2014)) • Practice of filing lawsuits with the strategy of extracting modest settlement fees from multiple parties (e.g., <i>TechRadium, Inc. v. FirstCallNetwork, Inc.</i>, No. 13-2487, 2015 U.S. Dist. LEXIS 23796, 2015 WL 862326 (S.D. Tex. Feb. 27, 2015); <i>Lumen View Tech., LLC v. Findthebest.com, Inc.</i>, 63 F. Supp. 3d 321 (S.D.N.Y. 2014)) • Failure to comply with local rules (e.g., <i>Logic Devices, Inc. v. Apple Inc.</i>, No. 13-2943, 2014 U.S. Dist. LEXIS 168380, 2014 WL 6844821 (N.D. Cal. Dec. 4, 2014)) • Misrepresentations about or inconsistencies with positions taken in the Patent Office (e.g., <i>Kilopass Tech., Inc. v. Sidense Corp.</i>, No. 10-cv-2066, 2014 U.S. Dist. LEXIS 112321, 2014 WL 3956703 (N.D. Cal. Aug. 12, 2014)) 	

On the other hand, courts since *Octane Fitness* also have indicated that there are continuing limitations on the availability of fee awards. In considering what knowledge a patent holder needs to justify suit, the Federal Circuit has reaffirmed that “tests or experiments on the actual accused products are not always necessary to prove infringement. In some instances, circumstantial evidence alone may suffice.” *Checkpoint Sys. v. All-Tag Sec. S.A.*, 572 F. App’x 988, 989 (Fed. Cir. 2014). Table 9.3 summarizes the factors considered by some district courts when denying fees under § 285.

Table 9.3
Facts Considered When Denying Fees Under § 285

Factors Considered in Denying Fees to Alleged Infringer	Factors Considered in Denying Fees to Patent Holder
<ul style="list-style-type: none"> • Infringement claims were reasonable, nonfrivolous, or made in good faith (e.g., <i>Site Update Sols. LLC v. Accor North America Inc.</i>, No. 11-cv-03306, 2015 U.S. Dist. LEXIS 17603, 2015 WL 581175 (N.D. Cal. Feb. 11, 2015)) • Case was a “close call” (e.g., <i>Eon Corp. IP Holdings LLC v. Cisco Sys. Inc.</i>, No. 12-cv-1011, 2014 U.S. Dist. LEXIS 101923, 2014 WL 3726170 (N.D. Cal. July 25, 2014)) • Court had to conduct extensive analysis to find in favor of alleged infringer (e.g., <i>Calypso Wireless v. T-Mobile USA Inc.</i>, No. 08-cv-00441, 2015 U.S. Dist. LEXIS 26871, 2015 WL 1022745 (E.D. Tex. Mar. 5, 2015)) • Adequate prefiling investigation (e.g., <i>CreAgri, Inc. v. PinnacLife, Inc.</i>, No. 11-cv-6635, 2014 U.S. Dist. LEXIS 77484, 2014 WL 2508386 (N.D. Cal. June 3, 2014)) • Reasonable belief in patent’s validity (e.g., <i>Collectors Universe, Inc. v. Blake</i>, No. 14-cv-333 (C.D. Cal. Mar. 18, 2015)) • Patent holder prevailed on some claim-construction issues (e.g., <i>CreAgri, Inc. v. PinnacLife, Inc.</i>, No. 11-cv-6635, 2014 U.S. Dist. LEXIS 77484, 2014 WL 2508386 (N.D. Cal. June 3, 2014)) • Claims dismissed for reasons other than the merits of claim (e.g., <i>Robinson v. Bartlow</i>, No. 12-cv-24, 2014 U.S. Dist. LEXIS 75105, 2014 WL 2468817 (W.D. Va. June 3, 2014)) • Denial of alleged infringer’s motion for summary judgment (e.g., <i>SFA Sys., LLC v. 1-800-Flowers.com, Inc.</i>, No. 09-cv-340, 2014 U.S. Dist. LEXIS 184311 (E.D. Tex. July 7, 2014)) • Alleged infringer’s failure to move for summary judgment (e.g., <i>Stragent, LLC v. Intel Corp.</i>, No. 11-cv-421, 2014 U.S. 	<ul style="list-style-type: none"> • No finding of willful infringement (e.g., <i>Ateliers de la Haute-Garonne v. Broetje Automation-USA, Inc.</i>, No. 09-cv-598, 2015 U.S. Dist. LEXIS 39850, 2015 WL 1022745 (D. Del. Mar. 30, 2015)) • No finding of exceptional or unreasonable conduct (e.g., <i>Transperfect Glob., Inc. v. Motionpoint Corp.</i>, No. 10-cv-2590, 2014 U.S. Dist. LEXIS 159805, 2014 WL 6068384 (N.D. Cal. Nov. 13, 2014)) • Both parties shifted theories throughout the case (e.g., <i>L.C. Eldridge Sales Co., Ltd. v. Jurong Shipyards PTE, Ltd.</i>, No. 11-cv-599 (E.D. Tex. Sept. 23, 2014))

Factors Considered in Denying Fees to Alleged Infringer	Factors Considered in Denying Fees to Patent Holder
<p>Dist. LEXIS 169080, 2014 WL 6756304 (E.D. Tex. Aug. 6, 2014))</p> <ul style="list-style-type: none"> • Case litigated in an efficient and cooperative manner (e.g., <i>The Tawnsaura Grp. LLC v. Maximum Human Performance LLC</i>, No. 12-cv-7189 (C.D. Cal. Sept. 4, 2014)) • Patent holder voluntarily dismissed claims (e.g., <i>Chao Tai Electron Co. Ltd. v. Ledup Enter., Inc.</i>, No. 12-10137 (C.D. Cal. Sept. 18, 2014)) • Alleged infringer’s winning argument was presented late in the case (e.g., <i>Robert Bosch LLC v. Snap-On Inc.</i>, No. 12-cv-11503 (E.D. Mich. Sept. 25, 2014)) 	

An attorneys’ fees award under the patent statute usually is restricted to the patent portion of the case. *Monolith Portland Midwest Co. v. Kaiser Aluminum & Chem. Corp.*, 407 F.2d 288, 297 (9th Cir. 1969). To the extent a case involves patent and nonpatent causes of action, no award of fees can be allowed under § 285 for the nonpatent theories unless the nonpatent theories are intertwined with the patent issues. *Id.*; *Beckman Instruments, Inc. v. LKB Producter AB*, 892 F.2d 1547, 1552 n.2 (Fed. Cir. 1989). Therefore, unless the exception applies, in considering attorneys’ fees under this provision, the court should require the moving party to separate out fees attributable to other causes of action in the case. The fees award, however, is not limited to costs of responding to “conduct found to be exceptional, . . . because it is the ‘totality of the circumstances,’ and not just discrete acts of litigation conduct, that justify the court’s award of fees.” *Homeland Housewares, LLC*, 581 F. App’x at 881.

9.2.4 Motion for a New Trial

Within twenty-eight-days after entry of judgment in a jury or court trial, with or without a motion for judgment as a matter of law, a party can move for a new trial. Fed. R. Civ. P. 59(b). As with Rule 50(b) motions, the time limit is jurisdictional and may not be extended. Fed. R. Civ. P. 6(b)(2). The motion is judged under the law of the regional circuit court of appeals, and in a patent case can be based on the same grounds as any trial. *See, e.g., Minton v. Nat’l Ass’n of Sec. Dealers, Inc.*, 336 F.3d 1373, 1378–79 (Fed. Cir. 2003). These include: (1) that the judgment is contrary to the weight of the evidence; (2) misconduct by an attorney or witness that denies an opponent fair consideration; (3) jury misconduct; (4) erroneous rulings regarding evidence, jury instructions, or trial conduct issues; (5) excessive (with or without a remittitur) or inadequate (with or without an additur) damages; and, (6) new evidence that could not have been discovered during trial. To merit granting a new trial, the subject of the motion must have caused substantial prejudice and, in virtually

all cases, have been the subject of a timely objection. *See generally* 12 Moore's Federal Practice § 59.13 (3d ed. 2007).

In patent cases, a motion for new trial is often used to challenge the claim construction provided in jury instructions. Typically, the jury instruction will simply adopt the claim construction set forth in the court's *Markman* order. Although it is usually clear from the *Markman* proceeding when a party disagrees with the court's construction, a party may still need to object to the jury instruction embodying the construction, depending on the circuit in which the trial court sits. Because regional circuit law governs Federal Rule of Civil Procedure 51 and the propriety of jury instructions, in some circuits, claim-construction briefing may not satisfy a party's obligation to object. *Serio-US Indus., Inc. v. Plastic Recovery Techs. Corp.*, 459 F.3d 1311, 1317 (Fed. Cir. 2006) (holding that appellant failed to timely object to claim construction under Fourth Circuit law even though the subject had been briefed); *Ecolab, Inc. v. Paraclipse, Inc.*, 285 F.3d 1362, 1369–70 (Fed. Cir. 2002) (deciding issue on merits (that there was no error), but noting that it would be “uncomfortable” to conclude that the Eighth Circuit would allow a futility exception in this case).

9.2.5 Renewed Motion for Judgment as a Matter of Law

Provided that a motion for judgment as a matter of law was made at the close of all the evidence (*see* § 8.4), a party may renew that motion within twenty-eight days after entry of judgment. *Jurgens v. McKasy*, 927 F.2d 1552, 1557 (Fed. Cir. 1991); *see also Wilson Sporting Goods Co. v. David Geoffrey & Assocs.*, 904 F.2d 677, 681 (Fed. Cir. 1990) (the law of the regional court of appeals determines whether the motion must be filed with the court or only served by the rule's deadline); Fed. R. Civ. P. 50(b). The rule's time limit for making the motion is jurisdictional and cannot be extended. Fed. R. Civ. P. 6(b); *see also U.S. Leather, Inc. v. H&W P'ship*, 60 F.3d 222, 224 (5th Cir. 1995). A renewed motion must be based on the same claimed failure of proof as the initial motion, and in judging it, the court should apply the same standard (*see* § 8.4). *Honeywell Int'l Inc. v. Hamilton Sundstrand Corp.*, 370 F.3d 1131, 1139 (Fed. Cir. 2004) (en banc); *Duro-Last, Inc. v. Custom Seal, Inc.*, 321 F.3d 1098, 1105–09 (Fed. Cir. 2003). The motion may be, and often is, joined with a motion for a new trial. Fed. R. Civ. P. 50(b). A joint motion permits the court to grant the new trial motion as an alternative, should the order granting judgment be reversed on appeal. Fed. R. Civ. P. 50(c)(1).

A renewed motion for judgment as a matter of law is the preferred mechanism by which the court can review the jury's decision on questions of law that are encompassed by a jury's verdict. “Many claims of invalidity rest, however, not upon factual disputes, but upon how the law applies to facts as given. . . . Where the ultimate question of patent validity turns on the correct answer to legal questions—what these subsidiary legal standards mean or how they apply to the facts as given— . . . [the clear-and-convincing burden of] proof has no application.” *Microsoft Corp. v. i4i Ltd.*, 131 S. Ct. 2238, 2253 (2011) (Breyer, J., concurring). Rather, the court must decide such embedded legal issues without any deference to the jury verdict.

For example, obviousness is a question of law, but it is often submitted to the jury because the ultimate conclusion is based on findings of fact (the *Graham* factors). If the jury was given special interrogatories addressing each of the *Graham* factors, the court can assess the propriety of the jury's findings based on the evidence presented at trial through a renewed motion for judgment as a matter of law. But even if the jury returns a general verdict of nonobviousness without further explanation, as explained in §§ 7.3.4.4.2, 14.3.5.3.5, the court must determine whether the ultimate legal conclusion is correct in light of disputed facts, implicit as well as explicit, that the jury necessarily determined. See *Kinetic Concepts, Inc. v. Smith & Nephew, Inc.*, 688 F.3d 1342 (Fed. Cir. 2012) (judging jury's implicit factual findings in general verdict of obviousness under substantial evidence standard). See also § 8.3.3.2 for a discussion regarding submission of the issue of obviousness to the jury.

9.2.6 Motion to Vacate Judgment in Connection with Settlement

Following the entry of final judgment, parties are sometimes able to settle before any appellate disposition. As part of the settlement agreement, the patentee and the accused infringer may agree to jointly ask the district court to vacate its judgment finding the patent invalid, not infringed, or unenforceable, as well as certain subsidiary rulings such as claim-construction orders that limit the patent's scope. In some cases, the parties will even make the settlement contingent upon the grant of vacatur. The motivation of the patentee in seeking vacatur is to strip any potential preclusive effect (for collateral estoppel purposes) associated with an adverse ruling regarding the patent's validity, scope, or enforceability. For the accused infringer, on other hand, this cost-free concession presumably helped it obtain monetary or other consideration from the patentee as part of the settlement. Vacatur allows it to share the anticompetitive benefits resulting from the deterrent effect of the restored patent, which could be asserted against its competitors.

Notwithstanding the fact that both parties to the litigation agree that a vacatur motion should be granted, the public interest and considerations of judicial economy often weigh against this outcome. See Jeremy W. Bock, *An Empirical Study of Certain Settlement-Related Motions for Vacatur in Patent Cases*, 88 Ind. L. J. 919 (2013) (synthesizing case law and analyzing empirical data on settlement-related motions for vacatur in patent cases over a five-year period); cf. *Lear, Inc. v. Adkins*, 395 U.S. 653, 674 n.19 (1969) (noting “the public's interest in the elimination of specious patents”); *Cardinal Chem. Co. v. Morton Int'l*, 508 U.S. 83, 100 (1993) (“[O]ur prior cases have identified a strong public interest in the finality of judgments in patent litigation.”); Jill E. Fisch, *Rewriting History: The Propriety of Eradicating Prior Decisional Law Through Settlement and Vacatur*, 76 Cornell L. Rev. 589, 593 (1991) (“[T]he effect of vacatur on the litigation process extends beyond judicial waste; it perverts the judicial decision into a negotiable commodity, engendering distortion of, and disrespect for, the role of the courts.”).

The alleged benefit of approving the vacatur request is that it will buy peace and reduce the costs of further judicial proceedings, such as appeal. These benefits, how-

ever, are speculative at best and more likely illusory. The empirical evidence, *see* Bock, 88 Ind. L. J. 919, and anecdotal evidence indicate that the parties will likely settle the matter even if the vacatur request is denied. More significantly, vacating the court's decisions construing the patent claims and/or ruling claims invalid or not infringed could well result in satellite litigation against other parties—possibly even competitors of the defendant.

Vacating any judgment based on the parties' settlement is an "extraordinary remedy" that should be granted only in "exceptional circumstances" that go beyond the parties' desire to include such a remedy in their settlement. *U.S. Bancorp Mortg. Co. v. Bonner Mall P'ship*, 513 U.S. 18, 26, 29 (1994). This is because "[j]udicial precedents are presumptively correct and valuable to the legal community as a whole. They are not merely the property of private litigants and should stand unless a court concludes the public interest would be served by a vacatur." *Id.* at 26 (citations omitted). Indeed, Federal Rule of Civil Procedure 60(b)(6), under which a settlement-related motion for vacatur is typically brought, requires a showing of "extraordinary circumstances." *See Liljeberg v. Health Servs. Acquisition Corp.*, 486 U.S. 847, 864 (1988) (observing that Rule 60(b)(6) "should only be applied in 'extraordinary circumstances'" (internal citations and quotation marks omitted). Moreover, a party that voluntarily declines to pursue an appeal by reason of settlement is not entitled to relief under Rule 60(b)(6). *See Ackermann v. United States*, 340 U.S. 193, 200 (1950) (holding that petitioner was not entitled to relief under Rule 60(b)(6) because of his "voluntary, deliberate, free, untrammelled choice . . . not to appeal"). Thus, absent exceptional circumstances, a motion to vacate a final judgment that is filed in connection with a settlement should be denied. *See Ohio Willow Wood Co. v. Thermoply, Inc.*, 629 F.3d 1374, 1376–77 (Fed. Cir. 2011) (Moore, J., concurring).

9.3 Appeal

After resolution of posttrial motions and entry of final judgment, a party may choose to appeal the judgment. While a notice of appeal to the Federal Circuit removes a patent matter from the district court's jurisdiction, there are a few issues a court must take up in conjunction with an appeal.

9.3.1 Stay of Injunction Pending Appeal

Injunctions are an often-requested remedy in patent cases. When an injunction has been issued and an appeal taken, the defendant will often request that the injunction be stayed pending appeal. Federal Rule of Civil Procedure 62(c) authorizes a district court, in its discretion, to stay an injunction when an appeal is taken. Moving for a stay of injunction in the district court pursuant to the Federal Rules is a prerequisite to requesting a stay in the Federal Circuit. Fed. R. App. P. 8.

While the literal reading of Rule 62(c) contemplates a request for a stay of injunction to be made following the filing of a notice of appeal, a court can, as a matter of judicial economy, consider a stay at the same time as the motion for permanent injunction. *See, e.g., A & L Tech. v. Resound Corp.*, 1995 U.S. Dist. LEXIS 22442, at

*9, 1995 WL 415146 (N.D. Cal. Mar. 15, 1995) (citing *Moxness Prods., Inc. v. Xomed Inc.*, 1988 U.S. Dist. LEXIS 16060, 1988 WL 193213 n.1 (N.D. Fla. 1988)); *Polaroid Corp. v. Eastman Kodak Co.*, 641 F. Supp. 828 (D. Mass. 1985), *aff'd*, 833 F.2d 930 (Fed. Cir. 1986).

In considering whether to grant a stay, the court must apply four factors:

- (1) whether the stay applicant has made a strong showing that he is likely to succeed on the merits
- (2) whether the applicant will be irreparably injured absent a stay
- (3) whether issuance of the stay will substantially injure the other parties interested in the proceeding
- (4) where the public interest lies

Standard Haven Prods., Inc. v. Gencor Indus., 897 F.2d 511, 512 (Fed. Cir. 1990); *E.I. DuPont deNemours & Co. v. Phillips Petroleum Co.*, 835 F.2d 277, 278 (Fed. Cir. 1987). The four factors should be weighed using a flexible balancing approach. *Standard Haven*, 897 F.2d at 512; *Arthrocare Corp. v. Smith & Nephew, Inc.*, 315 F. Supp. 2d 615, 619 (D. Del. 2004).

The requirement of showing irreparable injury to obtain a stay of an injunction is applied stringently because the court has already conducted an analysis finding an injunction appropriate. See *Malarkey v. Texaco, Inc.*, 794 F. Supp. 1248, 1250 (S.D.N.Y. 1992); *Crucible, Inc. v. Stora Kopparbergs Bergslags AB*, 594 F. Supp. 1249, 1264 (W.D. Pa. 1985), *aff'd in relevant part*, 793 F.2d 1565 (Fed. Cir. 1986) (“[The] plaintiff now is entitled to its injunction and [the defendant], therefore, should not be heard to complain of that which it had every reason to anticipate would be the result if it lost its gamble.”). Thus, irreparable harm for the purposes of a stay of injunction usually is not found unless the injunction will put the defendant out of business in the period pending appeal. A stay of injunction may be more appropriate if the defendant has a design-around, particularly if the patented feature is but one component in a multicomponent product. Under those circumstances, a court may stay the injunction and impose an ongoing royalty for the interim period to allow the defendant to continue its business while transitioning to the release of its design-around. The ongoing royalty amount should expressly take into account the fact that any ongoing use of the patented invention takes place following the grant of an injunction. *Amado*, 517 F.3d at 1362.

In the event that the district court denies a stay pending appeal, a party likely will ask the Federal Circuit to grant the stay. See generally Fed. R. App. P. 8. In conjunction with the request to the Federal Circuit, the party also may request that the district court grant a short stay allowing time for the party to prepare and obtain a ruling on its request from the Federal Circuit. In the event the district court does not grant this request, the party likely also will seek an interim stay from the Federal Circuit. *Id.*

9.3.2 Remands

Following review by the Federal Circuit, cases are often returned to a district court with more to do than simply enter an affirmed or other specified judgment. Rather, explicitly or implicitly, matters often are remanded to the district court for further unspecified proceedings consistent with the appellate court's mandate and opinion.

A remand not setting forth any specified action has the effect of broadly returning jurisdiction of the case to the district court. While anything encompassed explicitly or implicitly by the Federal Circuit's mandate must be followed, any action by the district court beyond the scope of the mandate is largely unfettered. In those proceedings, the district court can decide any issue not decided by the Federal Circuit. Even as to explicit direction given by the appellate court in the mandate, compliance is subject to a general rule of flexibility under the general law of the courts of appeal. A district court's action generally will not be reversed if the result is within that contemplated by the general terms of the mandate and not contrary to its explicit terms. *See, e.g., United States v. Kellington*, 217 F.3d 1084, 1095 n.12 (9th Cir. 2000).

Many remands from the Federal Circuit are essentially directions to the district court to reconsider its decision in light of the law as set out in the Federal Circuit's opinion. No outcome is implied by such a remand. It is entirely appropriate that further district court proceedings following a remand lead to an ultimate outcome other than that which would result from solely complying with the appellate mandate, or even a result reversed by an explicit mandate. For example, following reversal of a finding of patent invalidity based upon specified prior art, it is entirely proper for the district court to consider and find the patent invalid based upon other prior art, or otherwise in further proceedings to reach the result that the patent is invalid and enter judgment for the defendant. Similarly, for example, it is proper following reversal of a verdict of infringement for the district court in further proceedings to allow the addition of another patent to the suit and enter a judgment of infringement based upon it. Even as to the claims specifically considered by the Federal Circuit, further proceedings sometimes may result in entry of a judgment the same as that reversed: for example, an appellate reversal of a summary judgment does not preclude the district court's granting a second summary judgment motion based upon an altered claim construction or additional evidence; an appellate ruling that a claim or defense lacks sufficient evidence does not preclude hearing further evidence and finding the missing element is met.

In addition to the appellate mandate, an important limit on further district court proceedings following a remand is the "law of the case" rule. This rule provides that, once a case has been decided on appeal, the decision explicitly or implicitly adopted by the appellate court (excluding dicta) is to be applied, right or wrong, absent exceptional circumstances, in all subsequent proceedings of the lawsuit. *See, e.g., Gindes v. United States*, 740 F.2d 947, 949 (Fed. Cir. 1984). One important example of application of this rule is provided by claim constructions adopted by the Federal Circuit, including those of the district court affirmed by the Federal Circuit, which govern further proceedings whether within or outside the appellate court's mandate. *See, e.g., Ethicon Endo-Surgery, Inc. v. U.S. Surgical Corp.*, 149 F.3d 1309, 1315 (Fed.

Cir. 1998). Even here, however, while the district court may not alter the Federal Circuit's claim constructions, it properly may elaborate on the meaning intended by the Federal Circuit in further proceedings. *See, e.g., E-Pass Techs., Inc. v. 3Com Corp.*, 473 F.3d 1213, 1217–20 (Fed. Cir. 2007).

The limiting law-of-the-case rule does not apply when one of three exceptional circumstances exist: (1) the evidence in a subsequent trial is substantially different; (2) controlling authority has since made a contrary decision of the law applicable to the issues; or (3) the earlier ruling was clearly erroneous and would work a manifest injustice. *Ormco Corp. v. Align Tech., Inc.*, 498 F.3d 1307, 1319 (Fed. Cir. 2007). These departures from the law of the case properly are rare. *Toro Co. v. White Consol. Indus.*, 383 F.3d 1326, 1336–37 (Fed. Cir. 2004). For new evidence to justify a departure, it must be substantial and previously unavailable, a test the Federal Circuit has equated with that required for new evidence to justify a new trial pursuant to Federal Rule of Civil Procedure 60(b). *See Smith Int'l v. Hughes Tool Co.*, 759 F.2d 1572, 1579 (Fed. Cir. 1985). The law-of-the-case rule also does not apply to Federal Circuit opinions regarding preliminary injunctions; claim constructions, along with all other findings of fact and conclusions of law made or affirmed at the preliminary injunction stage, are subject to change by the district court as the case progresses. *See, e.g., Guttman, Inc. v. Kopykake Enters.*, 302 F.3d 1352, 1361 (Fed. Cir. 2002).

Chapter 10

ANDA and Biologics Cases: Patent Infringement Actions Involving FDA-Approved Drugs

10.1	Hatch-Waxman Act Statutory Scheme	2
10.1.1	Abbreviated New Drug Applications (ANDA) and Paragraph IV Certifications	4
10.1.2	Approval of ANDAs and First ANDA Filer's 180-Day Exclusive Marketing Period	7
10.1.3	The § 505(b)(2) Pathway for Drug Approval	9
10.2	The Hatch-Waxman Act's Impact on Patent Litigation	10
10.2.1	Personal Jurisdiction to Resolve Patent Issues in ANDA Cases	10
10.2.2	Subject-Matter Jurisdiction to Resolve Patent Issues in ANDA Cases	11
10.2.2.1	Jurisdiction over Infringement Actions by NDA Holders Arising from Paragraph IV Certifications	11
10.2.2.2	Declaratory Judgment Jurisdiction Arising from Paragraph IV Certifications	12
10.2.2.2.1	Declaratory Judgment Actions by First ANDA Filers	13
10.2.2.2.2	Declaratory Judgment Actions by Subsequent ANDA Filers	13
10.2.3	Case Management	14
10.2.3.1	Scheduling and Timing of Judgment	14
10.2.3.2	Order of Trial Presentation	15
10.2.3.3	Remedies in ANDA Litigation	16
10.2.3.4	Local Patent Rules in Hatch-Waxman Act Cases	16
10.2.3.5	Scheduling Orders in Hatch-Waxman Case Management: Chief Judge Stark, District of Delaware	18
10.2.4	Settlement of Hatch-Waxman Patent-Infringement Lawsuits	19
10.2.4.1	Reverse Payments (Pay-for-Delay Settlements)	19
10.2.4.2	Antitrust Issues with Reverse Payments Pre- <i>Actavis</i>	20
10.2.4.3	<i>FTC v. Actavis, Inc.</i> : Reverse-Payment Settlements May Be Anticompetitive	21
10.2.4.4	Hatch-Waxman Litigation Post- <i>Actavis</i> : Disputed Terms and Settlements	21
10.2.4.4.1	Legal Definitions of "Reverse Payment" and "Large"	22
10.2.4.4.2	FTC's Role in Reverse-Payment Settlement Cases	23
10.2.4.4.3	State Antitrust Law's Interaction with <i>Actavis</i>	24
10.3	Biologics and the BPCIA	24
10.3.1	Patent Infringement Actions Involving Biosimilar Products Under the BPCIA	24
10.3.2	The Biosimilar Application Pathway	25
10.3.2.1	Definition of a Biologic	26
10.3.2.2	The Pioneer Biologic License Application (BLA)	26
10.3.2.3	Period of Exclusivity for the Pioneering Company ("Reference-Product Exclusivity")	26
10.3.2.4	Approval of the § 351(k) Biosimilar or Interchangeable BLA	27
10.3.3	Premarket Litigation Procedures Under § 351(l) of the Public Health Services Act (42 U.S.C. § 262(l))	28
10.3.3.1	Information Provided by the Biosimilar Applicant	30
10.3.3.2	Exchange of Patent Contentions	30
10.3.3.3	Supplementation of Patent Contentions	31
10.3.3.4	Selection of Patents for First Phase of Litigation	31
10.3.3.5	Litigation of the First-Phase Patents	32
10.3.3.6	Notice of Commercial Marketing and Second Phase of Litigation	32
10.3.3.7	Remedies	33
10.3.4	Current Cases Testing the Boundaries of the BPCIA Prelitigation Procedures	33
Appendix 10.1	Glossary of Hatch-Waxman-Related Terms	37
Appendix 10.2	ANDA Scheduling Order from Chief Judge Stark	39
Appendix 10.3	ANDA-Specific Local Patent Rules	47

The interplay of FDA regulation of pharmaceutical products and the Patent Act produces several distinctive issues for patent case management. (It also produces its own distinctive vocabulary, glossed in Appendix 10.1.) Most issues result from Congress's efforts to streamline generic drug manufacturers' competition with drugs encompassed only by expired or invalid patents in the Drug Price Competition and Patent Term Restoration Act of 1984 (more commonly known as the Hatch-Waxman Act). Prior to the passage of the Hatch-Waxman Act, a generic drug manufacturer that wanted to challenge a patent encompassing a marketed drug typically needed first to obtain marketing approval from the FDA. Once this was allowed, it could begin to manufacture and sell the generic drug in this country, and thus create the basis for federal jurisdiction to adjudicate a pharmaceutical patent's validity, enforceability, and scope. The cost of obtaining such approval, as well as the uncertainty regarding a patent's validity and scope, discouraged entry by generic manufacturers until after a patent expired. The FDA approval process thus extended the effective term of patents encompassing an innovative drug for several years after the patents' expiration.

To address this unintended patent-term extension, the Hatch-Waxman Act established a unified framework to coordinate drug approval and resolution of patent rights relating to generic versions of patented drugs. *See* 21 U.S.C. § 355(j). The Act expedites litigation regarding potential patent infringement of generic drugs to quickly resolve validity and infringement issues. It thereby helps generic drug manufacturers to begin marketing noninfringing products sooner. Understanding this statutory and policy scheme and the economic effects it exerts on the pharmaceutical industry can assist the management of cases involving pharmaceutical patents.

In 2010, Congress supplemented this legislation with the Biologics Price Competition and Innovation Act to provide a similar scheme for biologics litigation. Unlike the identical, small-molecule generic drugs the Hatch-Waxman Act governs, biologics are "highly similar." *See* § 10.3 below.

10.1 Hatch-Waxman Act Statutory Scheme

Congress passed the Hatch-Waxman Act to strike "a balance between two competing policy interests: (1) inducing pioneering research and development of new drugs, and (2) enabling competitors to bring low-cost, generic copies of those drugs to market." *Andrx Pharm., Inc. v. Biovail Corp.*, 276 F.3d 1368, 1371 (Fed. Cir. 2002); *see also In re Barr Labs., Inc.*, 930 F.2d 72, 76 (D.C. Cir. 1991) ("Congress sought to get generic drugs into the hands of patients at reasonable prices—fast."). To meet these objectives, the Act rewards pioneering drug companies with protection of their patent rights. However, it also encourages generic drug companies to enter the market at the earliest possible time consistent with these patent rights by providing for a potentially shortened and cheaper regulatory approval process for generic drugs. The key move legislators made in developing Hatch-Waxman was to permit the ANDA filer to rely on the pioneering drug company's clinical data. Before Hatch-Waxman, few generics were available on the market because there is little economic

incentive in generating data and completing clinical trials on a product that cannot be patented.

A pioneering pharmaceutical company seeking FDA approval of a new drug must submit a New Drug Application (NDA) that includes extensive test data, usually from a series of human clinical trials, proving the safety and efficacy of the drug. 21 U.S.C. § 355(b). The FDA designates a drug approved based on human clinical trials as a Reference Listed Drug (RLD). Generic competitors instead are permitted to submit an Abbreviated New Drug Application (ANDA) that shortcuts this process by relying on the clinical trial data submitted for the NDA. The ANDA applicant need not conduct independent human trials or other tests. It can prove the safety and efficacy of the generic drug through evidence that it is equivalent to the pioneering drug. 21 U.S.C. § 355(j)(2)(A). The Hatch-Waxman Act motivates generic drug manufacturers to challenge any applicable patent rights held by the NDA-holder, by granting the first ANDA filer a 180-day market exclusivity period following the ANDA's approval by the FDA if the patent challenge succeeds. During this exclusivity period, only the first ANDA challenger, the NDA-holder and companies licensed by the NDA-holder may market their drugs. 21 U.S.C. § 355(j)(5)(B)(iv).

Resolution of patent rights is an important element of ANDA proceedings. The Hatch-Waxman Act protects the pioneering drug company's patent rights by providing that the act of filing an ANDA that challenges an NDA-holder's patent rights is an "artificial act of infringement" that "enables the judicial adjudication" of claims for infringement and patent invalidity. *Eli Lilly & Co. v. Medtronic, Inc.*, 496 U.S. 661, 678 (1990); *see also* § 271(e)(2)(A). Under normal circumstances, no ANDA will be approved until approximately thirty months after a patent infringement suit has been filed by the NDA holder against the ANDA applicant under § 271(e). 21 U.S.C. § 355(j)(5)(B)(iii). This provision encourages any dispute about the validity and applicability of an NDA-holder's patent rights to be adjudicated before the FDA approves a generic company's ANDA.

The statutory scheme envisions that ANDA patent litigation will be resolved before the thirty-month stay expires. Often, however, the litigation extends beyond the thirty-month stay. If the thirty-month stay expires while litigation remains pending, some ANDA-holders may attempt to launch, although they risk infringing the drug's patent. Likewise, NDA-holders will often seek a preliminary injunction to prevent an at-risk launch when the stay period expires. Launching at risk substantially changes an ANDA case because now the eventual trial could occur before a jury because postlaunch damages will be available to the plaintiff/NDA holder. When only prospective injunctive relief is in play, before the "at-risk" launch, the case would be tried before a judge.

The Hatch-Waxman Act also allows some ANDA applicants to reach the market without litigation. Under § (viii) of the statutory scheme, an ANDA applicant can carve out applicable method-of-use patents from its proposed drug label. It thereby avoids the "artificial act of infringement" under § 271(e), so long as there also are other, unpatented uses of the drug substance. 21 U.S.C. § 355(j)(2)(A)(viii); *see generally AstraZeneca Pharm. LP v. Apotex Corp.*, 669 F.3d 1370, 1376–80 (Fed. Cir. 2012). If a drug's label does not include an infringing use, the drug's manufacturer

does not infringe or induce infringement of a method-of-use patent simply by making and selling the drug. See *Warner-Lambert Co. v. Apotex Corp.*, 316 F.3d 1348 (Fed. Cir. 2003). Even with a carve-out, however, if a generic drug manufacturer makes statements on its labels or engages in other actions that promote the infringing use of the drug, the generic company can be liable for inducing infringement. See *AstraZeneca LP v. Apotex, Inc.*, 633 F.3d 1042 (Fed. Cir. 2010). A § (viii) ANDA filer is not subject to the thirty-month stay in approval, but neither is it entitled to the 180-day exclusivity period.

10.1.1 Abbreviated New Drug Applications (ANDA) and Paragraph IV Certifications

Before an ANDA filer can obtain FDA approval of its application, it must establish that its generic drug will not infringe valid patents for the equivalent pioneering drug. To accomplish this, the Hatch-Waxman Act provides that a pioneering drug company's NDA must disclose all patents that cover the drug or a method of using the drug in a manner encompassed by the NDA. 21 U.S.C. § 355(b)(1), (c)(2). The FDA lists all such patents in a publication (available online at www.fda.gov/cder/ob/default.htm), commonly referred to as the "Orange Book," providing notice of the pioneering drug company's patents to the public. For patented methods of use, the NDA holder also must submit a "use code description," for the FDA-approved uses or indications of the drug that are patented. 21 C.F.R. § 314.53. The FDA determines whether a carve-out under § (viii) (21 U.S.C. § 355(j)(2)(A)(viii)) is appropriate based on the use-code description supplied by the NDA holder. NDA filers may not list methods of manufacturing the drug in the Orange Book. 21 C.F.R. § 314.53. The FDA does not audit what the NDA filer lists on the Orange Book in any way; this position has been upheld by courts. 21 C.F.R. § 314.53(f); see, e.g., *aaiPharma, Inc. v. Thompson*, 296 F.3d 227, 235–44 (4th Cir. 2001).

As part of an ANDA filing, a generic drug manufacturer must submit certifications addressing each of the patents listed in the Orange Book that cover the relevant listed drug. 21 U.S.C. § 355(j)(2)(A)(vii); see *Eli Lilly*, 496 U.S. at 677. Specifically, the ANDA filer must certify:

- (i) that the [NDA-required] patent information has not been filed;
- (ii) that such patent has expired;
- (iii) the date on which such patent will expire; or
- (iv) that such patent is invalid or will not be infringed by the manufacture, use, or sale of the new drug for which the ANDA application is submitted.

21 U.S.C. § 355(j)(2)(A)(vii). Alternatively, the ANDA filer may file a § (viii) statement certifying that a method of use patent listed by the pioneering drug company "does not claim a use for which the applicant is seeking approval." 21 U.S.C. § 355(j)(2)(A)(viii); *AstraZeneca*, 669 F.3d at 1374. The ANDA filer may also split a particular patent, making a Paragraph IV certification as to a particular listed use and a § (viii) carve-out statement as to a second listed use.

A certification that an Orange Book–listed patent is invalid or not infringed is commonly known as a Paragraph IV certification. For each patent as to which an ANDA filer makes a Paragraph IV certification, it must provide “a detailed statement of the factual and legal basis for the opinion of the applicant that the patent is invalid or will not be infringed” or is unenforceable to both the patent owner and the NDA holder. 21 U.S.C. § 355(j)(2)(B)(iv)(II); *see* 21 C.F.R. 314.95(c)(6). Only by filing such a Paragraph IV certification can an ANDA filer obtain FDA approval to market a generic version of a listed drug for a patented use before the expiration or invalidation of an Orange Book–listed patent. *Eli Lilly*, 496 U.S. at 677. Because the Hatch-Waxman Act requires a detailed legal statement, it does not waive privilege, even when drafted by or based on the opinion of an attorney. *See Nycomed, Inc. v. Glenmark Generics Ltd.*, 2009 U.S. Dist. LEXIS 95780, 2009 WL 3334365, at *2 (E.D.N.Y. Oct. 14, 2009).

The Patent Act makes the filing of a Paragraph IV certification an act of patent infringement and allows the Orange Book–listed patent holder to initiate an infringement suit before the generic manufacturer sells any product. § 271(e)(2); *AstraZeneca*, 669 F.3d at 1377; *Glaxo Grp. Ltd. v. Apotex, Inc.*, 376 F.3d 1339, 1351 (Fed. Cir. 2004). A § (viii) filing, however, does not create a cause of action, and therefore, a patent holder cannot initiate suit in response. *See AstraZeneca*, 669 F.3d at 1379–80. If the Orange Book–listed patent holder files an infringement action within forty-five days of receiving notice of a Paragraph IV certification for any patent listed in the Orange Book prior to when the ANDA was filed, then the effective date of the FDA’s approval of the generic company’s ANDA application is automatically stayed for up to thirty months from the date of receipt of notice of the application to the patent owner and NDA holder. For patents filed by the NDA holder in the Orange Book after the ANDA is filed, the ANDA holder still must submit a Paragraph IV certification or § (viii) statement (21 C.F.R. § 314.94(12)(viii)(C)), but the late-listed, or “pop-up,” patent does not trigger an automatic stay. *See Eli Lilly & Co. v. Teva Pharm. USA*, 557 F.3d 1346, 1351 n.1 (Fed. Cir. 2009).

Filing an ANDA is only a “technical act of infringement,” as noted above, that establishes jurisdiction under § 271(e). To prove actual infringement, an NDA holder has the burden to prove the product to be sold will infringe patent claims. *See Ferring B.V. v. Watson Labs., Inc.*, 764 F.3d 1401 (Fed. Cir. 2014). Courts analyze the product to be sold against the asserted patent claims, and drug manufacturers must sell only products that comply with the ANDA drug description. *Id.* at 1408. Sometimes the ANDA specification will describe a drug that meets every claim limitation, but where the ANDA specification does not establish infringement outright, the Federal Circuit has endorsed the use of evidence such as tests of the product (in *Ferring*, tests submitted to the FDA). *Id.* at 1408–09. Evaluation of infringement focuses only on the final product complying with the terms of the ANDA—not on test drugs—because only the final product can be sold. *Id.* at 1409 (*see also Tyco Healthcare Grp. LP v. Mutual Pharm. Co.*, 762 F.3d 1338, 1344 (Fed. Cir. 2014) (finding that a patent owner may “allege infringement under § 271(e)(2)(A) if the patent owner has evidence that the as-marketed commercial ANDA product will infringe, even though the hypothetical product specified in the ANDA could not infringe”)).

When the ANDA does not describe the potentially infringing product, the patentee must demonstrate by a preponderance of the evidence that the ANDA applicant “would likely sell an infringing composition pursuant to an approved ANDA.” *Ferring*, 764 F.3d at 1388 (quoting *Glaxo, Inc. v. Novopharm, Ltd.*, 110 F.3d 1562, 1570 (Fed. Cir. 1997)).

If the applicant files an amended ANDA during the course of the FDA’s consideration, the “application” consists of the ANDA as filed and all amendments allowed by the FDA during the litigation. *Id.* at 1390. Allowing an amendment “is within the discretion of the district court.” *Id.* at 1390–91. But where an amendment has been allowed, and where the original ANDA literally infringed a patent at issue, but the amended ANDA and product to be sold do not infringe, there is no infringement. *Id.*

Any FDA approval of the ANDA during the thirty-month stay period is “tentative,” and does not become a “final approval” allowing actual marketing of the drug unless prior to expiration of the thirty months, all the relevant patents expire, the ANDA applicant obtains a favorable district court or Federal Circuit judgment, or the suit is settled with an agreement that the ANDA applicant’s marketing can commence. 21 U.S.C. § 355(j)(5)(B)(iii). A district court also has discretion to shorten or extend the thirty-month stay if “either party to the action failed to reasonably cooperate in expediting the action.” *Id.*; see *Eli Lilly & Co. v. Teva Pharm. USA*, 557 F.3d 1346 (Fed. Cir. 2009) (affirming six-month extension of automatic stay following generic manufacturer’s alteration of its product just before and production of samples and records of the altered product after close of discovery). Alternatively, a court can enjoin marketing of the ANDA filer’s generic drug under the usual preliminary injunction standards. § 271(e)(4)(B); see, e.g., *Altana Pharma AG v. Teva Pharm. USA, Inc.*, 566 F.3d 999, 1005 (Fed. Cir. 2009); see generally Chapter 3. And the thirty-month stay on final FDA approval will be extended if the NDA holder’s drug is either: (1) a new chemical entity (NCE), that is, a chemical compound not previously approved for marketing by the FDA, in which case the stay is extended to seven and a half years after the NCE was approved for marketing (21 U.S.C. § 355(j)(5)(F)(ii)); or (2) a drug with pediatric-specific labeling supported by a clinical trial involving children, in which case the stay is extended six months (which may be added to the NCE period for a total of eight years) (21 U.S.C. § 355a(b)).

If no infringement action is filed during the 45-day period after the ANDA filer provides notice of its filing, the FDA may approve the ANDA within 180 days after the ANDA application was filed (a period which is often extended by agreement between the FDA and ANDA filer), and the approval is immediately effective. 21 U.S.C. § 355(j)(5)(A), (B)(iii). In that circumstance, the ANDA first-filer may be entitled to the 180 days of market exclusivity described in the next section.

Under this statutory scheme, “‘Orange Book listing elevates every patent as a potential source of delay to generic competition,’ because listing gives ‘the patentee/NDA holder almost automatic injunctive relief for even marginal infringement claims.’” *Andrx Pharm.*, 276 F.3d at 1378 n.6. The potential delay sometimes has motivated questionable conduct by NDA holders, such as listing in the Orange Book patents of doubtful validity or applicability to the listed drug. See generally *Caraco Pharm. Labs. v. Novo Nordisk*, 132 S. Ct. 1670, 1678 (2012). If an ANDA applicant

disputes an Orange Book listing to the FDA, the agency will do no more to determine the propriety of a listing of a patent or its indicated use code than to require the NDA holder to confirm the correctness of the listing. *See* 21 C.F.R. § 314.53(f); *Bayer Schering Pharma AG v. Lupin, Ltd.*, 676 F.3d 1316, 1324 (Fed. Cir. 2012) (FDA does not determine whether patents should be listed); *Apotex, Inc. v. Thompson*, 347 F.3d 1335, 1347–50 (Fed. Cir. 2003) (the FDA is not required to determine the correctness of patent listings). As a result, to obtain correction the ANDA applicant must make a Paragraph IV certification and litigate the listed patent’s scope. The Orange Book listing’s potential for delay also has encouraged some NDA owners to attempt to “evergreen” the delay of generics by listing patents sequentially obtained on additional uses of the same basic drug over several years. *See Andrx Pharm.*, 276 F.3d at 1378 n.6. As long as an added patent is listed in the Orange Book before the relevant ANDA application is filed, it will result in a thirty-month stay of FDA approval if litigation is filed.

10.1.2 Approval of ANDAs and First ANDA Filer’s 180-Day Exclusive Marketing Period

The effectiveness of a tentative FDA approval of a second or later-filed ANDA application also can be substantially delayed by the Hatch-Waxman Act’s 180-day exclusive marketing period granted to the first ANDA applicant filing a Paragraph IV certification challenging the validity or infringement of Orange Book-listed patents encompassing a product. This delay can be substantially longer than 180 days, and potentially can become an indefinite period before later ANDA filers can obtain FDA approval and begin marketing their drugs. *See, e.g., Dey Pharma, LP v. Sunovian Pharm. Inc.*, 677 F.3d 1158, 1164–65 (Fed. Cir. 2012); *Caraco Pharm. Labs., Ltd. v. Forest Labs. Inc.*, 527 F.3d 1278, 1285 (Fed. Cir. 2008); *Apotex, Inc. v. Pfizer Inc.*, 385 F. Supp. 2d 187, 190 (S.D.N.Y. 2005) (“Some brand name drug manufacturers have succeeded in ‘parking’ the 180-day marketing exclusivity period, indefinitely delaying ANDA approvals and bottlenecking the market. Federal Trade Commission, ‘Generic Drug Entry Prior to Patent Expiration,’ vi–vii (July 2002).”), *aff’d*, 159 F. App’x 1013 (Fed. Cir. 2005), *cert. denied*, 549 U.S. 970 (2006).

This 180-day period of market exclusivity is provided to encourage a generic drug company to take on the potential burden and expense of challenging an Orange Book-listed patent via a Paragraph IV certification, helping to open the door for itself and other generic drug companies to enter the market with lower-cost drugs. 21 U.S.C. § 355(j)(5)(B)(iv). The period of exclusivity is effected by delaying the effective date of an FDA approval of any later-filed ANDA’s generic drug based on the same NDA until the expiration of the first ANDA filer’s period of exclusivity. *Id.* § 355(j)(5)(B)(iv)(II)(bb). Thus, the ANDA first-filer has exclusivity, but only against subsequent Paragraph IV filers. Its exclusivity does not prevent competitive drugs sold by the patentee, entities licensed by the patentee, or (if the FDA concludes a carve-out is available) § (viii) filers.

For ANDA applications filed before December 8, 2003, the period of exclusivity began either on the date the first Paragraph IV ANDA filer began marketing its ge-

neric or on the date of a final court decision finding the relevant Orange Book-listed patents invalid or not infringed (a decision that could occur either in a suit brought by the initial or a later ANDA filer (*see Minn. Mining & Mfg. Co. v. Barr Labs., Inc.*, 289 F.3d 775, 780 (Fed. Cir. 2002)), whichever is first. 21 U.S.C. § 355(j)(5)(B)(iv) (2000). This exclusivity period applies regardless of whether the first ANDA filer is successful in establishing the Orange Book-listed patents as invalid or not infringed.

For ANDA applications filed after December 8, 2003, the first Paragraph IV ANDA filer's marketing of the generic is the only trigger for the exclusivity period. 21 U.S.C. § 355(j)(5)(B)(iv) (2003). The exclusivity period, however, can be surrendered under certain circumstances. Most importantly, the exclusivity period is forfeited if the first ANDA filer fails to begin marketing its drug before the later of two statutorily defined dates. 21 U.S.C. § 355(j)(5)(D)(i)(I). The first of these dates is the earlier of:

- (i) 75 days after effective FDA approval of the first ANDA filer's application; or,
- (ii) 30 months after submission of the first ANDA application.

Id. The second of the statutorily defined dates is seventy-five days after the date one of the following occurs as to all the patents in the first ANDA filer's Paragraph IV certification:

- (i) a decision, final except for possible review by the Supreme Court, in a suit by the first or a later, tentatively-FDA approved ANDA filer that each Orange Book-listed patent in the first ANDA filer's Paragraph IV certification (the relevant patents) is invalid or not infringed;
- (ii) entry of an agreed judgment, pursuant to a settlement agreement, that each of the relevant patents is invalid or not infringed; or,
- (iii) withdrawal by the NDA holder of the relevant patents from listing in the Orange Book.

Id. Because the statute specifies that marketing must commence before the *later* of the two defined dates, if no event in the second group of dates occurs (because, for example, the NDA holder and ANDA applicant reach a settlement agreement that does not include entry of a judgment regarding the status of the patents), the FDA has taken the position that there is no forfeiture of the 180-day marketing period even though the first date has passed. *See* Teva North America, FDA Decision Letter: ANDA 77-165: Granisetron Hydrochloride Injection, 1mg/mL, Docket No. 2007N-0389 (Jan. 17, 2008), *available at* <http://www.fda.gov/ohrms/dockets/DOCKETS/07n0389/07n-0389-let0003.pdf>. As a result, the period by which the first ANDA filer must begin marketing to avoid forfeiture of the 180-day exclusivity period can be extended indefinitely under this provision.

The exclusivity period can also be forfeited by other events, although they are relatively rare: (1) withdrawal of the first ANDA application; (2) amendment of the first ANDA filer's Paragraph IV certification to remove all the relevant patents; (3) failure of the first ANDA filer to obtain approval of its application within thirty months of filing; (4) the first ANDA filer entering into an agreement found by the FTC or Attorney General, and affirmed in a judgment final except for possible Su-

preme Court review, to violate the antitrust laws; or (5) expiration of all the relevant Orange Book–listed patents. *See* 21 U.S.C. § 355(j)(5)(D). The FTC and Justice Department take the position that settlement agreements between first ANDA filers and holders of an NDA involving reverse payments violate the antitrust laws, and the Supreme Court implicated antitrust scrutiny for reverse payments in the 2013 *FTC v. Actavis, Inc.* decision. *See* § 10.2.4 below.

A further complication is that there can be multiple “first” ANDA filers as to a particular NDA. While only one “first” ANDA application can be filed per “drug,” 21 U.S.C. § 335(j)(5)(B)(iv)(bb), each different dose, for example, is considered a different “drug.” *See* 21 C.F.R. § 314.3 (“Drug product means a finished dosage form, for example, tablet, capsule, or solution, that contains a drug substance, generally, but not necessarily, in association with one or more other ingredients.”). Thus, it is possible to have multiple first ANDA filers with 180-day exclusive marketing periods for dosages or forms of the same underlying drug product that originally was approved under a single NDA. Multiple ANDA filers can share exclusivity on the same drug if they file on the same day and also file a Paragraph IV certification on at least one of the patents. Guidance for Industry: 180-Day Exclusivity Window When Multiple ANDAs Are Submitted on the Same Day (July 2003), <http://www.fda.gov/downloads/drugs/guidancecomplianceregulatoryinformation/guidances/ucm072851.pdf>. Multiple subsequent ANDA filers may challenge patents within the first ANDA filer’s Paragraph IV certifications.

10.1.3 The § 505(b)(2) Pathway for Drug Approval

As described above, most drug manufacturers seek FDA approval to market their drugs through either the NDA pathway for branded drugs, or through the ANDA pathway for generics. The Hatch-Waxman Act provides a third way for manufacturers to seek FDA approval to market a drug, the § 505(b)(2) pathway, if the drug is not entirely “new” but is also not a generic version of a branded drug. Typically, these drugs may have changes from the branded version and are not ANDA-eligible, but these changes (such as different dosage, strength, route of administration or substitution of one ingredient of a combination product) are slight, such that the manufacturer can rely in part on the “full reports of investigations” into the original drug on safety and efficacy issues. 21 U.S.C. § 355(b)(1). A manufacturer of such a drug is permitted to file an NDA under § 505(b)(2) on the drug even though the manufacturer did not conduct the original investigations on the drug, and the manufacturer “has not obtained a right of reference or use” from the original investigator(s). 21 U.S.C. § 355(b)(2).

A manufacturer submitting a § 505(b)(2) NDA application must provide the FDA with additional information showing that any differences between the original and § 505(b)(2) drugs will not affect the safety or efficacy of the § 505(b)(2) drug. A major advantage of this pathway is that the applicant can usually avoid certain types of clinical trials required for full NDA applications. 21 C.F.R. § 314.54(a). Finally, a § 505(b)(2) NDA applicant must certify whether its drug will infringe Orange Book–listed patents. 21 U.S.C. § 355(b)(2)(A). Like the filing of an ANDA application (*see*

§ 10.1.1), the filing of a § 505(b)(2) application for the purpose of commencing commercial manufacture, use or sale of a patented drug while a listed patent is in effect constitutes a technical act of infringement, allowing the patent owner to immediately commence suit before commercial activity begins.

10.2 The Hatch-Waxman Act's Impact on Patent Litigation

The substantive rights granted under the Hatch-Waxman Act greatly influence the litigation and marketing strategies of pharmaceutical companies. The statutory provisions significantly affect not only the litigation and market relationship between the pioneering drug NDA filer and the first generic drug ANDA filer, but also subsequent ANDA filers (i.e., later generic drug companies seeking entry into the market after the 180-day period of exclusivity). Drug companies have developed litigation strategies that attempt to take advantage of the benefits granted by the Hatch-Waxman Act while circumventing the countervailing purposes of the statute. Management of ANDA cases should take these issues into consideration. These strategies often have involved attempted manipulation of the ability of ANDA filers to obtain the requisite effective FDA approval of their applications and begin marketing by (1) avoiding resolution of all relevant Orange Book-listed patents, and thus the effective date of FDA approval of an ANDA with a Paragraph IV certification relating to those patents; and (2) extending, potentially indefinitely, the commencement of the first ANDA filer's 180-day exclusivity period.

The Hatch-Waxman Act also alters patent litigation in that suits under the Act usually involve no damages (*see* § 271(e)(4)(C); 21 U.S.C. § 355(j)(5)(c)(iii)), and thus, there is no right to a jury trial. *See Tegal Corp. v. Tokyo Electron Am. Inc.*, 257 F.3d 1331, 1339–41 (Fed. Cir. 2001); *In re Andrx Pharm., Inc.*, 399 F. App'x 582, 584 (Fed. Cir. 2010); *In re Apotex, Inc.*, 49 F. App'x 902, 903 (Fed. Cir. 2002).

10.2.1 Personal Jurisdiction to Resolve Patent Issues in ANDA Cases

Chapter 2.3.1 notes that under *Daimler AG v. Bauman*, ANDA plaintiffs must establish that a defendant is “essentially at home” in the forum state. *See* 134 S. Ct. 746 (2014).

This decision may cause more generic company defendants to challenge personal jurisdiction in jurisdictions that are neither the generic's place of incorporation or principal place of business. This decision may affect the distribution of ANDA cases nationally.

Since *Daimler*, district courts have continued to find personal jurisdiction in ANDA cases, either through specific contacts related to the filing of the ANDA or by consent. For example, in *AstraZeneca AB v. Mylan Pharmaceuticals*, No. 14-664-GMS, 2014 WL 5778016 (D. Del. Nov. 5, 2014), Judge Sleet found that there was specific personal jurisdiction. The court reasoned that the lawsuit arose out of Mylan's Paragraph IV certification sent to AstraZeneca in Delaware, and that Mylan should have “reasonably anticipate[d] being haled into court” in Delaware. *Id.* at 7.

Moreover, the court found that AstraZeneca “would be substantially burdened if forced to bring lawsuits against each ANDA filer in the defendants’ home states.” *Id.* As of the time of this publication, the issue of personal jurisdiction in this case has been certified for interlocutory appeal. *AstraZeneca AB v. Aurobindo Pharma Ltd.*, No. 14-664-GMS, 2014 WL 7533913, at *1 n.1 (D. Del. Dec. 17, 2014); *see also Eli Lilly & Co. v. Mylan Pharm.*, No. 14-cv-00389-SEB-TAB, 2015 WL 1125032 (S.D. Ind. Mar. 12, 2015) (finding specific personal jurisdiction in Indiana because of Mylan’s act of filing an ANDA and directing a Paragraph IV notice letter to Eli Lilly in Indiana, and because Eli Lilly would be burdened to bring suit in each ANDA filer’s home state).

A number of district court cases have adopted, to varying degrees, the reasoning that compliance with business registration statutes indicated consent to personal jurisdiction. *See Acorda Therapeutics, Inc. v. Mylan Pharm. Inc.*, 1-14-cv-00935-30, 2015 WL 186833 (D. Del. Jan. 14, 2015) (finding specific personal jurisdiction as well as finding that Mylan had consented to personal jurisdiction by complying with Delaware’s business registration statutes); *see also Forest Labs., Inc. v. Amneal Pharm.*, No. CV 14-508-LPS, 2015 WL 880599 (D. Del. Feb. 26, 2015) (finding Mylan had consented to personal jurisdiction by complying with business registration statutes); *Otsuka Pharm. Co. v. Mylan, Inc.*, No. Civ.A. 14-4508 JBS, 2015 WL 1305764, *12 (D.N.J. Mar. 23, 2015) (finding that certain Mylan entities consented to personal jurisdiction by complying with business registration statutes); *Senju Pharm. Co. v. Metrics, Inc.*, Civ. No. 14-3962 (JBS/KMW), 2015 WL 1472123 (D.N.J. Mar. 31, 2015) (finding Metrics had consented to personal jurisdiction by not only complying with New Jersey’s business registration statutes, but also by accepting service in New Jersey).

10.2.2 Subject-Matter Jurisdiction to Resolve Patent Issues in ANDA Cases

10.2.2.1 Jurisdiction over Infringement Actions by NDA Holders Arising from Paragraph IV Certifications

The Hatch-Waxman Act, in conjunction with the Patent Act, creates an artificial patent infringement cause of action and grants federal courts jurisdiction over that action once a Paragraph IV ANDA filer provides notice to a patent holder that the ANDA applicant believes the relevant Orange Book-listed patents are invalid or not infringed. 28 U.S.C. § 1338(a); § 271(e)(2); *see AstraZeneca Pharm. LP v. Apotex Corp.*, 669 F.3d 1370, 1376–77 (Fed. Cir. 2012). If the patent holder files an infringement suit within forty-five days of the ANDA filing, the Hatch-Waxman Act delays the effectiveness of FDA approval of the ANDA application for thirty months unless the litigation is ended earlier than that. 21 U.S.C. § 355(j)(5)(B). Not surprisingly, holders of Orange Book-listed patents often initiate patent infringement suits upon the filing of ANDA applications. They have strong incentives to delay the resolution of such litigation to prolong the stay of FDA approval for generic versions of

patented drugs for the full thirty months of possible delay. See FTC, Generic Drug Entry Prior to Patent Expiration: An FTC Study 49 (July 2002).

10.2.2.2 Declaratory Judgment Jurisdiction Arising from Paragraph IV Certifications

While it has always been clear that suit can be filed as to patents listed in a Paragraph IV certification, disputes over jurisdiction arise when the Paragraph IV certification implicates more than one Orange Book-listed patent and the NDA patent holder brought suit on fewer than all of them. Furthermore, although NDA patent holders have a strong incentive to file suit to trigger the thirty-month stay, they also have a strong incentive to avoid a litigation result that may allow the first ANDA filer to enter the market and start the 180-day period, after which subsequent ANDA filers may flood the market with generics.

Consequently, in cases where multiple Orange Book-listed patents are implicated, NDA patent holders sometimes initiate suit on fewer than all of the listed patents, typically the patent or patents with the earliest expiration date. By initiating suit, the NDA holder usually obtains an automatic thirty-month stay before FDA approval of the generic is effective. And even if the litigated patent or patents are found invalid or not infringed, the first ANDA filer still runs the risk of infringing the NDA-holder's other, unlitigated patents if it goes to market. This may discourage the first ANDA filer from beginning to market, and the 180-day period before other subsequent ANDA filers can enter the market will not be triggered by market entry. Nor is a finding of invalidity or noninfringement as to less than all of the Orange Book patents enough to trigger the start or potential forfeiture of the 180-day exclusivity period; this requires that all the relevant Orange Book-listed patents be found invalid or not infringed. 21 U.S.C. § 355(j)(5)(D)(i)(I); *Caraco Pharm. Labs., Ltd. v. Forest Labs. Inc.*, 527 F.3d 1278, 1287 (Fed. Cir. 2008). As a result, this strategy enables NDA holders to take advantage of the provisions for a thirty-month stay of effectiveness of FDA approval of generics without the corresponding risk of losing their market position. See *Teva Pharm. USA, Inc. v. Novartis Pharm. Corp.*, 482 F.3d 1330, 1343 (Fed. Cir. 2007) (patent holder suing on less than all its listed patents “has tried to simultaneously leverage the benefits provided to a patentee under the Hatch-Waxman Act and avoid the patentee’s accompanying responsibilities,” by “invok[ing] the statutory automatic 30-month stay and . . . concurrently insulating the . . . patents [not sued upon] from a validity challenge” or “any judicial determination of the metes and bounds of the scope of the claims”).

To prevent this strategy, Congress amended the Hatch-Waxman Act in 2003 to include a “civil action to obtain patent certainty” provision (CAPC) that allows an ANDA filer to file a declaratory judgment claim regarding all relevant Orange Book-listed patents if the NDA holder fails to sue upon all of them within the forty-five-day period. ANDA filers can use the CAPC provision to initiate declaratory judgment actions with respect to any relevant, unasserted Orange Book patent. If the declaratory judgment action asserts noninfringement, as opposed to solely invalidity, the ANDA filer must first make an “offer for confidential access,” allowing the NDA patent holder confidential access to its ANDA application to allow the patent holder

to determine whether to bring suit. 21 U.S.C. § 355(j)(5)(C)(i); see *Teva Pharm.*, 482 F.3d at 1330 (holding that in such circumstances there exists a justiciable case or controversy).

Also, if an NDA holder does file suit on a patent, an ANDA filer can file a declaratory judgment counterclaim to require the NDA holder to correct its NDA to remove an improperly listed patent or change its use code to describe more accurately the scope of a listed patent. 21 U.S.C. § 355(j)(5)(C)(ii); *Caraco Pharm. Labs. v. Novo Nordisk*, 132 S. Ct. 1670 (2012). Whether the Hatch-Waxman Act's counterclaim provision extends beyond requiring corrections in FDA listings and use codes is unsettled.¹

10.2.2.2.1 Declaratory Judgment Actions by First ANDA Filers

First ANDA filers desiring to take their generic drugs to market without the risk of infringement may use the CAPC provision to counterclaim or initiate actions for declaratory judgment of invalidity or noninfringement with respect to the relevant Orange Book patents not asserted by the NDA holders. See *Teva Pharm. USA, Inc. v. Novartis Pharm. Corp.*, 482 F.3d 1330, 1346 (Fed. Cir. 2007) (approving such suits). Among the reasons for the Federal Circuit's decision was that the NDA holder's suit on less than all the relevant patents was contrary to the intent of the provisions of the Hatch-Waxman Act. *Id.* at 1342–43. Specifically, the Federal Circuit found that the NDA holder was trying to “simultaneously leverage the benefits provided to a patentee under the Hatch-Waxman Act and avoid the patentee's accompanying responsibilities.” *Id.* at 1343.

10.2.2.2.2 Declaratory Judgment Actions by Subsequent ANDA Filers

Subsequent ANDA filers also have an interest in early resolution of patent rights due to the 180-day exclusivity period afforded to a successful first ANDA filer. Indeed, when first ANDA filers are unable or unwilling to bring their generics to market or obtain a court judgment of invalidity or noninfringement with respect to all relevant Orange Book patents, the only way a subsequent ANDA filer can start the 180-day exclusivity period is by obtaining its own court judgment of invalidity or noninfringement through a declaratory judgment action.

The Federal Circuit first addressed the issue of a subsequent ANDA filer's standing to bring declaratory judgment actions in *Caraco Pharmaceutical Laboratories, Ltd. v. Forest Laboratories, Inc.*, 527 F.3d 1278 (Fed. Cir. 2008). Forest (the NDA

1. District courts have held that the Hatch-Waxman Act's counterclaim provision only authorizes counterclaims seeking to delist patents from the Orange Book, and does not authorize other counterclaims (such as patent misuse) based on improper Orange Book listings. See *BrainTree Labs., Inc. v. Amruthan, Inc.*, Case No. 11-01854 (E.D. Pa. Feb. 24, 2012).

holder) sued on one of its Orange Book patents, but not the other. *Id.* at 1286. When the first ANDA filer failed to bring a declaratory judgment action regarding the other patent, Caraco, a subsequent ANDA filer, brought one. *Id.* at 1286–88. In an attempt to remove any case or controversy, Forest unilaterally granted Caraco a covenant not to sue. *Id.* at 1288. The Federal Circuit nevertheless found that even with Forest’s covenant not to sue, Caraco had standing to bring the action. *Id.* at 1291–92. Specifically, by seeking to prevent the FDA from approving ANDAs of generic drug manufacturers, Forest was effectively excluding Caraco from offering what it claimed to be a noninfringing generic drug. *Id.* at 1292. The Federal Circuit found this to be a restraint from the free exploitation of noninfringing goods, which has been recognized as a cognizable injury. *Id.* (citing *Red Wing Shoe Co. v. Hockerson-Halberstadt, Inc.*, 148 F.3d 1355, 1360 (Fed. Cir. 1998)). Subsequently, the Federal Circuit held that the same rule applied even if the declaratory judgment action alone was insufficient to allow the ANDA filer to market its drug, and it additionally would have to prevail in separate litigation brought by the NDA holder over other Orange Book patents. *Dey Pharma, LP v. Sunovian Pharm. Inc.*, 677 F.3d 1158 (Fed. Cir. 2012). By contrast, the Federal Circuit has held there is no jurisdiction for a subsequent ANDA filer’s declaratory judgment suit seeking only to eliminate the 180-day exclusivity period of the first ANDA filer. *Janssen Pharmaceutica, NV v. Apotex, Inc.*, 540 F.3d 1353 (Fed. Cir. 2008).

10.2.3 Case Management

10.2.3.1 Scheduling and Timing of Judgment

The Hatch-Waxman statutory framework affects not only the incentives for bringing suit but also the conduct of the parties during the litigation.

A Paragraph IV certification requires an ANDA filer to provide the NDA holder with a detailed statement of the factual and legal basis for its invalidity, unenforceability or noninfringement opinions. 21 U.S.C. § 355(j)(2)(B)(iv)(II); 21 C.F.R. § 314.95(c)(6). The parties to a patent lawsuit brought under the Hatch-Waxman Act therefore usually have more information at the start of the litigation than what is available at the start of a typical patent suit. For this reason, courts should be able to push for quicker resolution of issues than in a typical patent case.

An approach to case management that recognizes and utilizes the early availability of information is particularly important because NDA holders have strong motivation to delay resolution of the litigation at least until the thirty-month stay expires. During the thirty-month stay period, unless there is a final court judgment that the relevant Orange Book-listed patents are invalid or not infringed, the first ANDA filer cannot obtain FDA approval and take its generic to market. Therefore, by delaying resolution of the litigation until after the stay expires (and perhaps then seeking a preliminary injunction to prevent an at-risk launch), the NDA holder can delay market entry by the first ANDA filer and delay the start of the 180-day period before any subsequent ANDA filers can bring their generics to market. This has the effect of extending the NDA-holder’s monopoly on sales of the listed drug.

First ANDA filers may not necessarily oppose this delay. A court judgment of invalidity or noninfringement will start the clock on a first ANDA filer's 180-day exclusivity period. The first ANDA filer will want to delay that start until it is ready to market its drug to maximize its time as the sole generic provider. Subsequent ANDA filers, in contrast, are almost always interested in a speedy resolution to ensure an early trigger of the 180-day exclusivity period and thus an earlier time to entry of subsequent generic filers. Thus, in cases between an NDA holder and the first ANDA filer, a court may be required to manage a lawsuit in which neither party is interested in early resolution but are using the litigation to advance other objectives.

Courts can combat the strong incentive to delay by adopting expedited case schedules that take advantage of the invalidity, unenforceability and noninfringement contentions already available to the parties in the Paragraph IV certification and notice. Unlike many patent defendants, ANDA filers should be able to exchange their invalidity and noninfringement positions almost immediately upon commencement of the lawsuit, having prepared their required notice to the NDA holders. NDA holders similarly should be able to exchange their infringement and validity contentions at the commencement of litigation having had notice, usually for forty-five days before the suit is filed.

Courts can also directly combat attempts by the parties to delay litigation. The Hatch-Waxman Act explicitly grants courts the discretion to adjust the thirty-month stay period based on the parties' conduct during litigation. 21 U.S.C. § 355(j)(5)(B)(iii). Where a patent holder attempts to extend its patent exclusion through extensive litigation, a court may shorten the thirty-month period. *See Allergan, Inc. v. Alcon Labs., Inc.*, 324 F.3d 1322, 1337 n.5 (Fed. Cir. 2003) (Schall, J., concurring). Similarly, where an ANDA filer delays and fails to cooperate in discovery for example, the court may extend the period before the FDA may approve the ANDA. *See Eli Lilly & Co. v. Teva Pharm. USA, Inc.*, 557 F.3d 1346 (Fed. Cir. 2009). In exercising this discretion, the court should limit its considerations to the conduct of the parties in the litigation and not to positions taken before the FDA. *See Andrx Pharm., Inc. v. Biovail Corp.*, 276 F.3d 1368, 1376 (Fed. Cir. 2002). With this in mind, courts can establish disclosure and discovery deadlines that promote early resolution of ANDA cases.

10.2.3.2 Order of Trial Presentation

ANDA cases differ from most other patent cases in that, while the patent owner typically is the plaintiff, it is the ANDA defendant—the generic drug company—that bears the burden of proof on the issues that will be tried. This is because the gist of the usual ANDA case is invalidity or unenforceability, not noninfringement. The ANDA generic drug and associated label must be identical to the NDA-holder's drug and label, so if the patent covers the NDA-holder's drug, it very likely also covers the ANDA drug. Because of this reversal of the usual burden of proof (as discussed in § 8.1.2.2.2), it also may be appropriate to reverse the order of proof.

10.2.3.3 Remedies in ANDA Litigation

In many circumstances, courts are required to provide no remedy beyond a declaratory judgment at the conclusion of an ANDA case. If, before any final FDA approval, the NDA holder wins and the patent is declared valid and infringed, the FDA will not approve the ANDA application until the patent expires (§ 271(e)(4)(A)). This is accomplished by switching the ANDA filer's Paragraph IV certification to a Paragraph III certification. *See, e.g., Mylan Labs., Inc. v. Thompson*, 389 F.3d 1272, 1282–83 (D.C. Cir. 2004). If the district court judgment comes after the thirty-month stay expired and the ANDA holder began marketing its drug in an at-risk launch, the FDA will revoke the final approval and instead tentatively approve the ANDA drug, which has the effect of precluding further sales. Notwithstanding that the FDA's action precludes lawful sale of the ANDA applicant's drug, some courts additionally grant an injunction. *See, e.g., Sanofi-Synthelabo v. Apotex Inc.*, 294 F. Supp. 2d 353, 397 (S.D.N.Y. 2007), *aff'd*, 5590 F.3d 1075 (Fed. Cir. 2008), *cert. denied*, 130 S. Ct. 493 (2009).

If, on the other hand, the ANDA applicant wins in the district court, upon entry of the judgment any remaining part of the thirty-month stay is terminated, and, without more, the FDA will change its tentative approval of the ANDA to a final approval allowing the drug to be marketed. 21 U.S.C. § 355(j)(5)(B)(iii)(I)(aa). The FDA will grant this final approval even if the district court judgment is “stayed” pending appeal. *Sanofi-Aventis LLC v. Sandoz, Inc.*, 345 F. App'x 594 (Fed. Cir. 2009). If, following FDA approval, the ANDA holder markets its drug and the Federal Circuit subsequently reverses the district court judgment, finding infringement of a valid patent, the usual patent remedies—injunctive relief and damages—apply. Similarly, if the ANDA holder began marketing upon receiving FDA approval at the conclusion of a thirty-month stay before any district court judgment and the district court subsequently finds infringement of a valid patent, these usual remedies apply.

10.2.3.4 Local Patent Rules in Hatch-Waxman Act Cases

As discussed previously in Chapter 2, one way to facilitate the early resolution—or at least efficient resolution—of patent cases is the adoption or use of specialized local rules, which have proven to be a powerful case-management tool. Several courts have adopted patent local rules specific to Hatch-Waxman litigation. *See* D.N.J. L. Pat. R. 3.6; E.D. Tex. P. R. 3-8; N.D. Ohio L. P. R. 3.9; Dist. Idaho Loc. Patent R. 3-6; D. Md. Pat. L. R. 805.3; E.D. Mo. Local Patent R. 3-1(a)(viii); W.D. Tenn. LPR 3.10 (all printed in Appendix 10.3). The rules of these courts recognize the different availability of information in ANDA cases, and therefore reverse the typical order and timing for disclosure of infringement and invalidity contentions.

Ordinarily, plaintiff–patent holders have the initial advantage in patent litigation, controlling the timing of the litigation and having the opportunity to prepare and plan the infringement case well in advance of filing suit. Defendants, on the other hand, must investigate and develop noninfringement and invalidity positions while already in the throes of litigation. Consequently, typical local patent rules (including the District of New Jersey and Eastern District of Texas's rules governing

non-ANDA patent cases) require the plaintiff early in the litigation to provide detailed infringement contentions first, allowing the defendant some reasonable time thereafter to prepare and serve invalidity contentions.

The situation is somewhat reversed in Hatch-Waxman cases, however. It is the defendant in Hatch-Waxman cases that dictates the timing and scope of litigation through its ANDA filing. In addition, unlike a typical defendant, a defendant in a patent case brought under the Hatch-Waxman Act already has a “detailed statement of the factual and legal basis for the opinion of the applicant that the patent is invalid or will not be infringed” or is unenforceable prepared as part of its Paragraph IV certification. *See* 21 U.S.C. § 355(j)(2)(B)(iv)(II); 21 C.F.R. § 314.95(c)(6). Moreover, unlike the usual situation, a Hatch-Waxman plaintiff—the patent owner—may have little information about the defendant’s generic drug. There usually is no publicly available product from the generic company, so often the plaintiff knows only the information about the generic product required to be included in the Paragraph IV certification—that the generic is bioequivalent, has the same dosage, and uses the same route of administration.

Because a defendant in an ANDA case already has detailed invalidity and non-infringement contentions by the time suit is filed, the ANDA local patent rules require the defendant to provide its invalidity contentions first. *See* D.N.J. L. Pat. R. 3.6; E.D. Tex. P.R. 3-8. In addition, they impose a new obligation on an ANDA defendant to also provide its noninfringement contentions. Specifically, District of New Jersey Local Patent Rule 3.6 requires ANDA defendants to:

- (1) produce the entire ANDA that is the basis of the case by the initial scheduling conference;
- (2) provide the written basis for their “Invalidity Contentions” within 14 days after the initial scheduling conference; and
- (3) provide the written basis (including claim charts) for their “Non-Infringement Contentions” within 14 days after the initial scheduling conference.

Id. Forty-five days thereafter, the plaintiff is required to provide its infringement contentions. *Id.* Eastern District of Texas Local Rule 3-8 contains similar requirements on the same timetable.

In addition, both New Jersey Local Patent Rule 3.6(j) and Eastern District of Texas Local Patent Rule 3-8(e) amend the disclosure requirements for Hatch-Waxman cases. Both rules require parties with pending ANDA applications that form the basis for a litigation to notify the FDA of motions for injunctive relief no later than three business days after filing the motion. These parties must also provide a copy of correspondence between the FDA and any party regarding the ANDA application to each party bringing an infringement claim, or must “set forth the basis of any claim of privilege” for the correspondence, no later than seven days after receiving or sending correspondence. This rule is intended to aid in the coordination of FDA proceedings and district court litigation, and to avoid discovery issues about the production of FDA correspondence during litigation proceedings.

Apart from these changes in the disclosure order and times, ANDA cases are subject to the remaining patent local rules in both New Jersey and the Eastern District of Texas. The ANDA rules, for example, are silent with regard to the order of proof at trial.

The reversal of disclosure obligations and the additional requirement to provide noninfringement contentions was the subject of much discussion during the comment period for the District of New Jersey's local patent rules. Critics questioned the practice of requiring ANDA defendants to provide noninfringement contentions before knowing a plaintiff's theory of infringement, particularly when plaintiffs bear the burden of proving infringement. The requirement imposes an obligation on ANDA defendants to address patent claims that ultimately may not even be asserted by the plaintiff. Proponents argued the rules appropriately accounted for the special nature and availability of information in Hatch-Waxman cases. Because generics are not available on the market for a patent holder to conduct a thorough infringement analysis, plaintiffs should not be required to provide infringement contentions without full-disclosure of the ANDA filing and noninfringement arguments required by the local rules.

The District of New Jersey local patent rules were adopted after consideration of these concerns, and serve as a helpful guideline for management of Hatch-Waxman patent cases. Whether or not a disclosure schedule similar to the one proposed by the District of New Jersey is adopted, an understanding of the mechanics of the Hatch-Waxman Act can help courts fashion case-management techniques to take advantage of and address the particular incentives and interests of the parties and assist in the early resolution of ANDA cases.

10.2.3.5 Scheduling Orders in Hatch-Waxman Case Management: Chief Judge Stark, District of Delaware

Chief Judge Stark of the District of Delaware issued ANDA-specific scheduling orders on July 1, 2014. He elected to not apply several of the July 2014 patent procedures (printed in Appendices 7.1 and E) to ANDA cases, and thus these orders differ from his standard patent scheduling orders in several ways. First, the ANDA scheduling order removes the disclosures section present in the July 2014 patent instructions, and instead specifies dates by which the plaintiff and defendant shall produce or provide information such as identification of accused products, production of core technical documents, production of initial claim charts, and production of initial invalidity, final infringement, and final invalidity contentions.

In addition, the court will not hear case-dispositive motions in ANDA cases, absent agreement between the parties (this reflects how bench trials are typically handled in the District of Delaware). The ANDA-specific instructions also do not include any specific discussion about jury instructions, voir dire, and special verdict forms, given that typically these ANDA cases are bench trials. These instructions do not include a specific section on judgment on the verdict, or posttrial status reports. Finally, the orders do not give standard posttrial briefing instructions or page limits because these instructions and limits are determined on a case-by-case basis, usually

at the end of the trial. Both sides must attend posttrial briefing. A full copy of these rules is included in Appendix 10.2.

10.2.4 Settlement of Hatch-Waxman Patent Infringement Lawsuits

10.2.4.1 Reverse Payments (Pay-for-Delay Settlements)

Other than the automatic thirty-month stay on FDA approval of the ANDA, an NDA holder has little incentive to engage in litigation. Because the generic drug company is not yet selling a competing drug, an NDA holder cannot receive any damages, yet it still runs the risk of having its patents invalidated. In the best-case scenario, the NDA holder is in the same position it would be in without a lawsuit. And in the worst-case scenario, it loses its patent rights. For a generic ANDA holder, however, litigation is a low-risk proposition. In the worst-case scenario, apart from litigation expenses, the generic company is in the same position it was without litigation. In the best-case scenario, it can enter the market before expiration of the Orange Book-listed patents with a period of market exclusivity. Thus, in Hatch-Waxman patent lawsuits, the NDA holder bears the majority of the risk, creating risk-assessment that differs greatly from other patent cases. See *In re Ciprofloxacin Hydrochloride Antitrust Litig.*, 544 F.3d 1323, 1338, (Fed. Cir. 2008), *cert. denied*, 129 S. Ct. 2828 (2009).

In particular, NDA filers are highly motivated to settle in a manner that avoids the first ANDA filer's early market entry, not only to avoid the risk of having its patents found invalid or not infringed, but also because it has the incentive to delay market entry by all other generics. Because of the 180-day exclusivity period granted to first ANDA filers, by delaying a first ANDA filer's generic entry, the NDA holder can delay entry by all generics. As a result of this dynamic, NDA holders and first ANDA filers have economic incentives to reach settlement agreements that run counter to the goals of the Hatch-Waxman Act.

In the 1990s, NDA holders started entering into settlement agreements with first ANDA filers known as reverse-payment settlements. In contrast to typical patent case settlements in which payments flow from the alleged infringer to the patent holder, a reverse-payment settlement involves the patent owner (NDA holder) making payments² to the alleged infringer (the first ANDA filer) to settle the patent in-

2. Early reverse-payment settlements (those conducted before the mid-2000s) generally consisted of cash payments as considerations. Settlements since this time have become far more complicated. Settlements may use such terms as additional contract terms, agreements regulating other pharmaceutical products, or no cash used as consideration. Other provisions may include an intellectual property license, supply and distribution agreements, or co-promotion of brand-name products. One particular type of agreement under current investigation in several pending actions is the "no authorized generic" ("No-AG") agreement, in which the brand-name company agrees to not market its own generic brand against a generic manufacturer's product. See C. Scott Hemphill, *An Aggregate Approach to Antitrust: Using New Data and Rulemaking to Preserve Drug Competition*, 109 Colum. L. Rev. 629 (2009); C. Scott

fringement. The reverse payment would be made in exchange for the first ANDA filer's promise not to enter the market for a time period negotiated by the parties. Because of the exclusivity provisions of the Hatch-Waxman Act, such settlements allow NDA holders to pay one ANDA filer to delay entry by all other ANDA filers, effectively extending the term of protection for the NDA holder.

This scheme allows the NDA holder to avoid litigation risk and to guarantee market exclusivity for a period of time regardless of the merits of its patents. At the same time, the first ANDA filer is compensated for its delayed market entry and still enjoys a 180-day period of generic exclusivity once it enters the market.

10.2.4.2 Antitrust Issues with Reverse Payments Pre-Actavis

Prior to 2013, courts of appeal were deeply divided over the legality of reverse-payment settlements of Hatch-Waxman lawsuits under the antitrust laws. The Federal Trade Commission, joined by the United States Attorney General, continued to challenge such settlements as violations of the antitrust laws.³

In *In re Schering-Plough Corp.*, 136 F.T.C. 956 (2003), the FTC challenged a settlement whereby the NDA holder agreed to pay \$60 million in return for the generic's agreement not to enter the market for four years, even though the thirty-month stay (before the FDA could approve the generic) would expire in only one year. The commission found that the settlement agreement amounted to an unlawful restraint on trade. *Id.* at 1061. The Eleventh Circuit, however, reversed that decision, finding that the FTC failed to consider the exclusionary power of the patent, and the relative risk assessments created by the Hatch-Waxman Act, in assessing whether the settlement violated antitrust laws. *Schering-Plough Corp. v. FTC*, 402 F.3d 1056 (11th Cir. 2005). What must be considered is "the extent to which the exclusionary effects of the agreement fall within the scope of the patent's protection." *Id.* at 1076.

The Third Circuit reached a different conclusion in a later civil suit arising from the same agreement as *Schering-Plough*. *In re K-Dur Antitrust Litig.*, 686 F.3d 197 (3d Cir. 2012). In the Third Circuit's view, any payment from a patent-holding pharmaceutical company to a generic maker which agrees to hold off on entering the market is a prima facie restraint of trade and therefore evidences an antitrust violation. *Id.* at 218. Similar results were reached in decisions by the D.C. and Sixth Circuits. *In re Cardizem CD Antitrust Litig.*, 332 F.3d 896 (6th Cir. 2003); *Andrx Pharm., Inc. v. Biovail Corp. Int'l*, 256 F.3d 799 (D.C. Cir. 2001).

In contrast, decisions from the Second, Ninth, Eleventh, and Federal Circuit Courts of Appeals have upheld reverse-payment agreements in the face of antitrust challenges. See *In re Tamoxifen Citrate Antitrust Litig.*, 429 F.3d 370 (2d Cir. 2005)

Hemphill, *Drug Patent Settlements Between Rivals: A Survey* 1-49 (Columbia Law School, Working Paper, 2007), available at http://papers.ssrn.com/sol3/papers.cfm?abstract_id=969492.

3. The Federal Trade Commission can investigate and stop certain behaviors that violate the Sherman and Clayton Acts under the Federal Trade Commission Act. The FTC Act authorizes the FTC to bring suit against parties who enter into anticompetitive reverse-payment settlements. *FTC v. Brown Shoe Co.*, 384 U.S. 316, 322 (1966).

(holding that reverse-payment settlements are not necessarily unlawful restraints on commerce and do not represent anticompetitive agreements, particularly when the scope of the agreement falls within the coverage of the relevant patents); *Ark. Carpenters Health & Welfare Fund v. Bayer AG*, 604 F.2d 98 (2d Cir.) (applying *Tamoxifen* to affirm summary judgment against challengers of reverse-payment settlement), *reh'g denied*, 625 F.3d 779 (2d Cir. 2010); *Kaiser Found. Health Plan Inc. v. Abbott Labs., Inc.*, 552 F.3d 1033 (9th Cir. 2009) (jury finding of no antitrust injury from reverse-payment settlement agreement; independent *Walker Process* claim allowed to proceed); *FTC v. Watson Pharm., Inc.*, 677 F.3d 1298, 1311 (11th Cir. 2012), *rev'd sub nom. FTC v. Actavis, Inc.*, 133 S. Ct. 2223 (2013) (holding that reverse-payment agreement is valid, reiterating its view that “absent sham litigation or fraud in obtaining the patent, a reverse-payment settlement is immune from antitrust attack so long as its anticompetitive effects fall within the scope of the exclusionary potential of the patent”); *In re Ciprofloxacin Hydrochloride Antitrust Litig.*, 544 F.3d 1323 (Fed. Cir. 2008).

10.2.4.3 *FTC v. Actavis, Inc.*: Reverse-Payment Settlements May Be Anticompetitive

In June 2013, the Supreme Court held in a five-to-three decision that the FTC’s *FTC v. Watson Pharmaceuticals* lawsuit in the Eleventh Circuit should have proceeded, as reverse-payment settlements may be anticompetitive in some situations. *FTC v. Actavis, Inc.*, 133 S. Ct. 2223, 2225 (2013).

The decision mandated the use of a modified version of the antitrust “rule-of-reason” but did not hold that reverse-payment settlements are always presumptively unlawful. *Id.* at 2236–37. Instead, the Court ordered lower courts to apply a modified “rule-of-reason” antitrust analysis to these cases. *Id.* at 2237–38. The rule-of-reason test requires the plaintiff to demonstrate agreement between two or more persons intended to restrain or harm competition, actual injury to competition, and that the restraint or harm is “unreasonable.” *Cal. Dental Ass’n v. FTC*, 224 F.3d 942, 947 (9th Cir. 2000). The unreasonableness factor is determined by balancing injury against pro-competitive effects of the restraint. *See id.* Defendants bear the burden of proving any justifications or pro-competitive effects of a settlement; plaintiffs bear the burden of proving that the anticompetitive effects of a settlement outweigh any pro-competitive effects. *See id.*

The Court left development of the application of the “rule-of-reason” in reverse-payment cases to the lower courts, directing that lower courts should focus on the “basic question” of whether a settlement has “significant unjustified anticompetitive consequences.” *Actavis*, 133 S. Ct. at 2237.

10.2.4.4 Hatch-Waxman Litigation Post-*Actavis*: Disputed Terms and Settlements

Post-*Actavis*, lower courts have struggled to interpret the decision in a consistent manner, largely because the Court left much of the interpretation of the decision to them. This area of the law is under constant development, and a number of cases not

discussed below will have upcoming rulings that shape the law and interpretation in this field. Judges should make a thorough survey of the current state of the field at the outset of such a case, particularly since how courts should apply the rule of reason in these cases is a hotly debated issue.

10.2.4.4.1 Legal Definitions of “Reverse Payment” and “Large”

Much of the debate thus far has been over what the meaning of a “reverse payment” is under *Actavis*—in particular, whether nonmonetary compensation settlements implicate *Actavis*-based antitrust liability and what a “large” payment is. In addition, the Federal Trade Commission has shown renewed interest in bringing litigation actions in these types of cases. Finally, a few cases already have addressed the intersection of federal and state antitrust law in reverse-payment cases. These issues are discussed below.

As noted earlier, the *Actavis* decision did not specify what types of settlements qualify as “reverse payments.” In particular, the decision did not give guidance on whether the modified rule-of-reason analysis should apply to cases in which the settlements under consideration do not consist solely of cash payments. Courts have diverged significantly on whether nonmonetary compensation falls under the *Actavis* regime.

Only two district court decisions, one of which has been reversed, have restricted the definition of “reverse payment” to include settlements wherein only cash constituted the consideration. *In re Lamictal Direct Purchaser Antitrust Litig.*, No. 12-cv-995, 2014 WL 282755, at *1 (D.N.J. Jan. 24, 2014), *vacated*, *King Drug Co. of Florence, Inc. v. Smithkline Beecham Corp.*, No. 14-1243, 2015 WL 3967112 (3d Cir. June 26, 2015); *In re Loestrin 24 Fe Antitrust Litig.*, No. 1:13-md-2472-S-PAS, 2014 WL 4368924 (D.R.I. Sept. 4, 2014).

Most of the decisions thus far applying *Actavis* have acknowledged there may be antitrust liability for settlements including nonmonetary compensation. *See In re Nexium (Esomeprazole) Antitrust Litig.*, 968 F. Supp. 2d 367, 392 (D. Mass. 2013) (finding that the Supreme Court did not require that a reverse-payment settlement include a monetary exchange, noting that a “broader interpretation” of “payment” better reflected the current reality of settlements that oftentimes include terms beyond cash); *In re Niaspan Antitrust Litig.*, No. 13-MD-2460, 2014 WL 4403848 (E.D. Pa. Sept. 5, 2014) (holding that *Actavis* applies to reverse-payment settlements whether they involve cash or noncash payments); *In re Effexor Antitrust Litig.*, No. 11-cv-5479 (PGS), 2014 WL 4988410 (D.N.J. Oct. 6, 2014) (granting defendants’ motion to dismiss, as the plaintiff’s allegations failed to properly estimate the value of the alleged reverse payment, and thus the allegations were not plausible); *In re Lipitor Antitrust Litig.*, No. 3:12-cv-02389 (PGS), 2014 WL 4543502 (D.N.J. Sept. 12, 2014) (dismissing the claims after finding that plaintiffs had not reasonably estimated the cash value of the settlement at issue); *United Food & Commercial Workers Local 1776 & Participating Emp’rs Health and Welfare Fund v. Teikoku Pharma USA, Inc.*, No. 14-md-02521-WHO, 2014 WL 6465235, at *11 (N.D. Cal. Nov. 17, 2014) (interpreting the *Actavis* discussion on reverse payments to encompass nonmonetary settlement terms).

In June 2015, the Third Circuit became the first circuit court to rule on the applicability of *Actavis* to a nonmonetary payment in a reverse-payment settlement. *King Drug Co. of Florence, Inc. v. Smithkline Beecham Corp.*, No. 14-1243, 2015 WL 3967112 (3d Cir. June 26, 2015). The court examined the 2014 *Lamictal* decision mentioned earlier to determine whether *Actavis* liability applied to a settlement term in which the brand-name company agreed to relinquish its right to produce an authorized generic as a settlement term, and found that in this case, *Actavis* liability should apply. *Id.* at *1–2. The panel ruled that “this [no-authorized generic] agreement falls under *Actavis*’s rule because it may represent an unusual, unexplained reverse transfer of considerable value from the patentee to the alleged infringer and may therefore give rise to the inference that it is a payment to eliminate the risk of competition,” thereby implicating the *Actavis* rule-of-reason analysis for the settlement term. *Id.* at *2. The decision agreed with the majority of district court decisions that have found that the *Actavis* holding “can[not] be limited to reverse payments of cash.” *Id.* at *10.

The *Actavis* decision also did not define the term “large” in the context of payments; lower courts have begun to interpret this term. See *In re Lipitor*, 2014 WL 4543502, at *22 (holding that the plaintiffs did not provide “a measure of damages accepted within the industry and a discussion of the settlement factors relating to the claim.”); *In re Effexor*, 2014 WL 4988410, at *12 (holding that a loss estimate from an unrelated drug did not “specifically value the monetary amount of the no-authorized generic agreement in the instant case”). Finally, some courts have required complaints to meet the *Twombly* and *Iqbal* pleading standard by defining the value of the settlement. *In re Lipitor*, 2014 WL 4543502, at *25; *In re Effexor*, 2014 WL 4988410, at *15, *23.

10.2.4.4.2 FTC’s Role in Reverse-Payment Settlement Cases

Although the *Actavis* decision did not uphold the FTC’s preferred “presumption of illegality” standard from *In re K-Dur*, the Court’s rejection of the “scope of the patent” test encouraged the FTC to further investigate settlements and begin litigation.

The Federal Trade Commission has expressed its approval of the *Actavis* decision, stating that it would reexamine settlements in light of *Actavis* to determine whether further investigation was warranted. *Prepared Statement of the Federal Trade Commission on Pay-for-Delay Deals: Limiting Competition and Costing Consumers Before the United States Senate Comm. on the Judiciary, Subcomm. on Antitrust, Comp. Policy and Consumer Rights*, 113th Cong. 3 (July 23, 2013). Interestingly, the FTC reported that in fiscal year 2013, fewer potential reverse-payment settlements were reported than in the previous year. *FTC Bureau of Competition, Agreements Filed with the Federal Trade Commission under the Medicare Prescription Drug, Improvement, and Modernization Act of 2003, Overview of Agreements Filed in FY 2013*. But no good data are available yet on the frequency of reverse-payment settlements post-*Actavis*.

The FTC has pursued several actions post-*Actavis* against parties who allegedly entered into illegal reverse-payment settlements. *FTC v. Actavis, Inc.*, 133 S. Ct. 2223

(2013); *FTC v. Cephalon, Inc.*, No. 2:08-cv-02141 (E.D. Pa. 2014) (settled between the FTC and Cephalon by disgorgement for \$1.2 billion and an agreement to not settle patent disputes using pay-for-delay settlements in the future, 2015 WL 1724597 (E.D. Pa. Apr. 15, 2015)); *FTC v. AbbVie Prods., Inc.*, No. 14-5151 (E.D. Pa. 2014) (partially dismissed because the agreements at issue did not amount to pay-for-delay settlements, No. 14-5151, 2015 WL 2114380 (E.D. Pa. May 6, 2015)). Prior to *Actavis*, the FTC had brought suit in *FTC v. Cephalon*, an alleged reverse-payment settlement deal on Provigil, and it continued its activities in litigating the remand of the *Actavis* case itself. In September 2014, the FTC brought its first post-*Actavis* reverse-payment settlement suit against AbbVie and others based on an alleged agreement to delay the launch of generic Androgel. *AbbVie Prods., Inc.*, No. 14-5151 (E.D. Pa. 2014). On March 31, 2016, the FTC brought a suit against Endo Pharmaceuticals and multiple generic companies, alleging that the no-authorized generic settlement terms in agreements settling litigation on painkillers Opana ER and Lidoderm are reverse-payments prohibited under *Actavis*. *FTC v. Endo Pharms. Inc.*, No. 16-cv-1440-PD (E.D. Pa. 2016).

10.2.4.4.3 State Antitrust Law’s Interaction with *Actavis*

In a state antitrust law class action based on an alleged reverse payment, the court ruled that no federal question jurisdiction arose because the resolution of the plaintiffs’ *Actavis*-based claims did not require the litigation of patent law issues. *Time Ins. Co. v. AstraZeneca AB*, No. 14-4149, 2014 WL 4933025, at *1 (E.D. Pa. Oct. 1, 2014). Here the court did not find it necessary to litigate the validity of AstraZeneca’s patents in order to determine whether state antitrust law had been violated. *Id.* at *2.⁴

10.3 Biologics and the BPCIA

10.3.1 Patent Infringement Actions Involving Biosimilar Products Under the BPCIA

The Public Health Service Act (PHSA), as amended in 2010 by the Biologics Price Competition and Innovation Act (BPCIA), sets out a complex scheme for evaluation of biosimilar⁵ products. It also contains extensive provisions addressed to

4. The California Supreme Court recently held that pay-for-delay settlements can be challenged under state antitrust law, following the decision in *Actavis*. The court drew parallels between federal antitrust law and state antitrust law in making its decision, determining that nothing in California antitrust law precedent suggested that it was more limited than the federal law discussed in *Actavis*. The court instructed lower courts to use the rule-of-reason test to analyze these settlements. *In re Cipro Cases I & II*, No. S198616, 2015 WL 2125291 (Cal. Sup. Ct. 2015).

5. A “biosimilar” product is one that is “highly similar to the reference product notwithstanding minor differences in clinically inactive components,” and as to which there

patent infringement litigation between the reference-product sponsor company and those seeking to produce a biosimilar product. Much as in the Hatch-Waxman context governing small-molecule drugs, the specialized statutory scheme governing biosimilar products has important implications for biosimilar patent case management.

Biosimilar patent disputes under the BPCIA differ from those governed by the Hatch-Waxman Act in a number of important ways, all of which are discussed in more detail in the following sections.

First, the BPCIA sets out a unique, bilateral, and complex prelitigation “patent dance,” intended to provide robust exchange of information, and narrowing of issues, well in advance of litigation. However, whether and to what extent these prelitigation exchanges are mandatory is the subject of ongoing litigation.

Second, there is no central listing of relevant patents like the Orange Book in the biologics context; the statute contemplates that the patents to be litigated are defined in the prelitigation exchanges between the parties. In addition, there are no limitations on the types of patents (assuming that they potentially cover the biologic at issue) that can be asserted in these exchanges.⁶

Third, and related, the statute contemplates the possibility of a two-phase litigation, with different patents litigated in each phase. The parties select in prelitigation negotiations the patents to be litigated in each phase. Under the statute, the parties negotiate and determine the patents to be asserted in an initial phase of litigation. If there are relevant patents that were identified in the prelitigation exchanges but not litigated in the first phase of litigation, those patents may be litigated after the biosimilar sponsor provides a statutorily mandated notice that it intends to market its biosimilar product.

As can be seen from the above description, case management for BPCIA cases is likely to be complex and challenging. Active case management will be essential to successful disposition of these cases.

At the time of this writing, the biosimilar and patent litigation provisions of the BPCIA are largely untested in the courts, and the provisions, while detailed, leave many unanswered questions regarding how biosimilar patent cases will proceed. A number of recent cases squarely present some of these issues, and are discussed in detail below.

10.3.2 The Biosimilar Application Pathway

A background understanding of the pathway for biosimilar applications (codified as § 351(k) of the BPCIA) is helpful to contextualize and understand the timing and impact of the statute’s patent litigation provisions.

are no clinically meaningful differences from the reference product in terms of safety, purity, or potency. 42 U.S.C. § 262(i), PHSA § 351(i)(2).

6. Both of these features suggest that more patents may be asserted in any given BPCIA matter than in a Hatch-Waxman matter.

10.3.2.1 Definition of a Biologic

Under the BPCIA, a biological product is “a virus, therapeutic serum, toxin, antitoxin, vaccine, blood, blood component or derivative, allergenic product, protein (except any chemically synthesized polypeptide), or analogous product, or arsphenamine or derivative of arsphenamine (or any other trivalent organic arsenic compound), applicable to the prevention, treatment, or cure of a disease or condition of human beings.” 42 U.S.C. § 262(i)(1), BPCIA § 351(i)(1).⁷ The FDA has defined a “protein” as “any alpha amino acid polymer with a specific defined sequence that is greater than 40 amino acids in size.” Chemically synthesized polypeptides are “any alpha amino acid polymer that (1) is made entirely by chemical synthesis; and (2) is less than 100 amino acids in size.” Biosimilars: Questions and Answers Regarding Implementation of the Biologics Price Competition and Innovation Act of 2009 (Guidance for Industry) (Apr. 2015), <http://www.fda.gov/downloads/Drugs/GuidanceComplianceRegulatoryInformation/Guidances/UCM444661.pdf>

In other words, biologics generally are manufactured through biologic synthesis—they are manufactured in or extracted from living systems. Such biological products also are usually “drugs” for purposes of the Food and Drug Cosmetic Act (FDCA). They are exempted from the NDA provisions of that Act, although they are subject to the other FDCA provisions that apply to drugs and to those provisions that expressly apply to biologics. 42 U.S.C. § 262(j), BPCIA § 351(j). Certain biologics have in the past been the subject of approved NDAs under the FDCA, rather than BLAs, and will shift to the BLA pathway in 2020 pursuant to transition provisions included in the BPCIA.

10.3.2.2 The Pioneer Biologic License Application (BLA)

A pioneering company seeking to market a new biologic shall submit to the FDA a Biologic License Application (BLA), analogous to an NDA in the drug context, called a § 351(a) BLA. 42 U.S.C. § 262(a), BPCIA § 351(a). A § 351(a) BLA normally includes exhaustive data demonstrating the proposed product’s safety, purity, and potency, as well as manufacturing data and consent to the inspection of the manufacturing facility. *Id.* If the § 351(a) BLA is approved, the approved drug is referred to as the “reference product” for purposes of any subsequent biosimilar BLA.⁸ 42 U.S.C. § 262(i)(4), BPCIA § 351(i)(4).

10.3.2.3 Period of Exclusivity for the Pioneering Company (“Reference-Product Exclusivity”)

A § 351(k) BLA may not be filed until four years after the approval of the reference product, and may not be approved until twelve years after approval of the refer-

7. For ease of reference, citations in this section will be to both Title 42 of the U.S. Code and the corresponding section of the BPCIA.

8. The biosimilar BLA pathway is set out in the BPCIA’s § 351(k), and is referred to as a “section 351(k) BLA.”

ence product. 42 U.S.C. § 262(k)(7)(A)–(B), BPCIA § 351(k)(7)(A)–(B).⁹ This period of exclusivity is wholly independent of patent protection. *Id.*

The BPCIA prevents the sponsor of a reference drug from extending exclusivity based on small changes to the biologic where the sponsor or a related entity seeks a subsequent § 351(a) BLA on (1) a nonstructural change resulting in a new indication, dosage form, dosing schedule, delivery device or system, route of administration, or strength, or (2) a structural change that does not result in a difference in safety, purity, or potency. 42 U.S.C. § 262(k)(7)(C); BPCIA § 351(k)(7)(C).¹⁰ This provision prevents multiple extensions of exclusivity based on small changes to the original biologic.

10.3.2.4 Approval of the § 351(k) Biosimilar or Interchangeable BLA

A § 351(k) applicant may file an application for licensure as a biosimilar or interchangeable biological product. 42 U.S.C. § 262(k); BPCIA § 351(k). The application is intended to demonstrate sufficient similarity between the reference and biosimilar biologic product to permit reliance on the approval of the reference product BLA. To that end, to determine biosimilarity, the FDA shall determine whether the proposed biologic is “highly similar” to the reference product “notwithstanding minor differences in clinically inactive components” and “has no clinically meaningful differences from the reference product in safety, purity, or potency.” 42 U.S.C. § 262(i)(2); BPCIA § 351(i)(2).¹¹

The statutory scheme also provides for approval of biologics that are “interchangeable” with the reference product. 42 U.S.C. § 262(k)(4); BPCIA § 351(k)(4). To be determined interchangeable with the reference product, the biologic shall be (1) biosimilar and (2) expected to produce the same clinical result as the reference product in any given patient. *Id.* In addition, if the product is to be administered more than once, there must be no greater risk in terms of safety or diminished efficacy in switching between the reference product and the product under examination than there is in using the reference product without such a switch.

A biological product found to be interchangeable is entitled to a period of exclusivity, during which no other product may be approved as an interchangeable under the statute. 42 U.S.C. § 262(k)(6); BPCIA § 351(k)(6).

9. Under certain circumstances, an additional six months of exclusivity based on pediatric testing extends these periods. 42 U.S.C. § 262(k)(7)(A) & (B). Seven-year orphan exclusivity, which runs concurrently with reference-product exclusivity, also may apply.

10. The FDA has indicated it may not issue exclusivity decisions at the time of licensure, particularly in difficult or complex cases, and as a result duration of exclusivity may not be settled prior to litigation. FDA, Draft Guidance for Industry, Reference Product Exclusivity for Biological Products Filed Under Section 351(a) of the PHS Act (Aug. 2014) at 7.

11. Such differences, permissible under the statute, may lead to more claims of non-infringement in the BPCIA context than in the Hatch-Waxman context.

10.3.3 Pre-Market Litigation Procedures Under § 351(l) of the Public Health Services Act (42 U.S.C. § 262(l))

An application submitted under § 351(k) of the BPCIA is subject to the patent litigation provisions of § 351(l) of that Act.¹² As discussed above, those provisions are quite different from the prelitigation procedures of the Hatch-Waxman Act.

Broadly speaking, § 351(l) sets out three stages of prelitigation procedures. First, the biosimilar applicant shall provide its application and information about its manufacturing process to the reference-product sponsor, subject to default statutory confidentiality provisions. Second, the parties may engage in detailed exchanges of contentions relating to patents potentially covering the biosimilar product. Finally, the parties identify a set of patents for a first phase of litigation.¹³ The U.S. Court of Appeals for the Federal Circuit has held that these prelitigation procedures are not mandatory and that it is permissible under the statute for a biosimilar applicant to decline to participate in the prelitigation procedures. *Amgen Inc. v. Sandoz Inc.*, 794 F.3d 1347, 1354–57 (Fed. Cir. 2015).

Where followed, the exchanges pursuant to the prelitigation provisions of the BPCIA force the parties to develop and test their contentions, and identify critical issues, prior to litigation. Moreover, the exchanges under § 351(l) are bilateral and the information provided to the reference-product sponsor significantly more complete than in the Hatch-Waxman context, discussed earlier. As a result, the parties should be even better situated to resolve the matter with minimal delay.

The exchanges also set the stage for the litigation in important ways. They define the patents that may be litigated, the timing of the litigation, and the remedies that may be sought by the reference-product sponsor.

To the extent that the biosimilar applicant declines to engage in the statute's prelitigation procedures, the consequence is exposure on the part of the biosimilar applicant to an immediate infringement suit brought by the reference-product sponsor.¹⁴

Tables 10.1 and 10.2 provide a visual diagram of the steps of patent litigation outlined in further detail.

12. The BPCIA does not contemplate reliance on the litigation provisions of § 351(l) by § 351(a) applicants, despite the fact that patent infringement actions may arise out of products licensed under § 351(a).

13. Ultimately, if there are any remaining relevant patents, those patents may be litigated in the months before market entry by the biosimilar product.

14. *See id.*

Table 10.1
First Phase of Litigation Steps: Immediate Patent Infringement Action
After Applicant Is Notified that FDA Has Accepted Biosimilar Application

Time	Action	Notes
Within 20 days	Applicant provides application and manufacturing information (42 U.S.C. § 262(l)(2); BPCIA § 351(l)(2))	N/A
Within 60 days	Reference-product sponsor discloses patent list (42 U.S.C. § 262(l)(3)(A); BPCIA § 351(l)(3)(A))	Later-issued or licensed patents must be identified in a supplemental list no later than 30 days from the issuance/ licensing (42 U.S.C. § 262(l)(7); BPCIA § 351(l)(7))
Within 60 days	Applicant discloses patent list and detailed statement(s) (42 U.S.C. § 262(l)(3)(B); BPCIA § 351(l)(3)(B))	Reference-product sponsor shall supplement BPCIA § 351(l)(3) list with later-issued or exclusively licensed patents within 30 days of issuance or licensing; applicant shall respond with detailed statement(s) within 30 days (42 U.S.C. § 262(l)(7); BPCIA § 351(l)(7))
Within 60 days	Reference-product sponsor responds to applicant detailed statement(s) (42 U.S.C. § 262(l)(3)(C); BPCIA § 351(l)(3)(C)) Parties negotiate on list of patents for immediate infringement action (42 U.S.C. § 262(l)(4); BPCIA § 351(l)(4))	
Within 15 days from start of negotiation	If no agreement, exchange lists based on number of patents applicant listed (42 U.S.C. § 262(l)(5); BPCIA § 351(l)(5))	
Within 30 days	First phase patent litigation commences (42 U.S.C. § 262(l)(6); BPCIA § 351(l)(6))	

Table 10.2
Second Phase of Litigation Steps

<ul style="list-style-type: none">• Applicant provides notice to the reference-product sponsor no later than 180 days before the date of first commercial marketing (42 U.S.C. § 262(l)(8)(A); BPCIA § 351(l)(8)(A))
<ul style="list-style-type: none">• After receiving notice of commercial marketing, the reference-product sponsor may seek a preliminary injunction on the basis of any patent that was listed under (l)(3) or (l)(7) and not included on the lists for BPCIA § 351(l)(4) or (l)(5) (42 U.S.C. § 262(l)(8)(B); BPCIA § 351(l)(8)(B))

10.3.3.1 Information Provided by the Biosimilar Applicant

Under the patent litigation provisions of § 351(l), a § 351(k) applicant shall provide a copy of its application and information about its manufacturing process to the reference-product sponsor within twenty days after the FDA notifies the applicant that its application has been accepted for review. 42 U.S.C. § 262(l)(2); BPCIA § 351(l)(2). Until adoption of a protective order governing confidentiality, the materials provided to the reference-product sponsor are subject to default confidentiality provisions under § 351(l)(1)(A), though the parties can agree to modifications of the rules. 42 U.S.C. § 262(l)(1)(A); BPCIA § 351(l)(1)(A).

The statute provides that, if a § 351(k) applicant provides the relevant materials, neither the applicant nor the reference-product sponsor may bring a declaratory judgment action until the reference-product sponsor receives a notice of commercial marketing under the statute or the applicant fails to comply with certain of the patent litigation provisions under § 351(l). 42 U.S.C. § 262(l)(9); BPCIA § 351(l)(9).

However, if the § 351(k) applicant “fails” to provide the materials required by the statute to the reference-product sponsor, the reference-product sponsor can bring an immediate declaratory judgment action. BPCIA § 351(l)(9)(C); 42 U.S.C. § 262(l)(9)(C).

As discussed below in § 10.3.4, the Federal Circuit has found that the exchange detailed in § 351(l)(2)(A) is permissive and not mandatory. *Amgen Inc.*, 794 F.3d at 1354–57.

10.3.3.2 Exchange of Patent Contentions

Within sixty days of receipt of the § 351(k) applicant’s application and manufacturing information, the reference-product sponsor shall provide a list of patents it believes that it could reasonably assert against the applicant (the reference-product sponsor’s “initial list”). BPCIA § 351(l)(3)(A); 42 U.S.C. § 262(l)(3)(A). It shall also indicate whether it would be willing to license the patents listed. *Id.* The reference-product sponsor’s initial list is of critical importance, as the owner of a patent that should have been, but was not, included on the reference-product sponsor’s list will

be precluded from bringing suit on that patent as to the biologic at issue. § 271(e)(6)(C).¹⁵

Within sixty days of receipt of the reference-product sponsor's initial list, the biosimilar applicant shall respond with either (1) detailed, claim-by-claim contentions regarding any claim of noninfringement, invalidity, or unenforceability; or (2) a statement that it will not market its product until patent expiry. BPCIA § 351(l)(3)(B); 42 U.S.C. § 262(l)(3)(B). It may also provide a list of patents upon which it believes the reference-product sponsor could bring an infringement claim (the biosimilar applicant's "initial list"). BPCIA § 351(l)(3)(A); 42 U.S.C. § 262(l)(3)(A). If the reference-product sponsor has made an offer to license, the biosimilar applicant shall respond to the offer. BPCIA § 351(l)(3)(B)(iii); 42 U.S.C. § 262(l)(3)(B)(iii). Failure by the § 351(k) applicant to provide this response can form the basis for a declaratory judgment action. BPCIA § 351(l)(9); 42 U.S.C. § 262(l)(9).

Within sixty days of receiving the applicant's contentions, the reference-product sponsor shall in turn respond with detailed contentions regarding infringement, validity, and enforceability. BPCIA § 351(l)(3)(C); 42 U.S.C. § 262(l)(3)(C). These contentions shall also be set out on a claim-by-claim basis. *Id.*

10.3.3.3 Supplementation of Patent Contentions

If, after the reference-product sponsor provides its initial list of patents to the applicant, a relevant patent issues or is exclusively licensed to the reference-product sponsor, the reference-product sponsor shall supplement its list within thirty days. BPCIA § 351(l)(7); 42 U.S.C. § 262(l)(7). The biosimilar applicant shall respond within thirty days, providing detailed noninfringement, invalidity and/or unenforceability contentions. Any patents on the supplemental list will not be litigated in the first phase of litigation, but will be addressed, if at all, in the second phase of litigation. BPCIA § 351(l)(7); 42 U.S.C. § 262(l)(7).

10.3.3.4 Selection of Patents for First Phase of Litigation

From the exchanges described above, the parties identify a set of patents for the first phase of litigation. For the fifteen days following the response of the reference-product sponsor, the parties shall negotiate in good faith to identify the patents that will be litigated immediately. BPCIA §§ 351(l)(4)(A), (B); 42 U.S.C. §§ 262(l)(4)(A), (B). If they agree, the reference-product sponsor shall bring suit on those patents within thirty days (the "agreed list for litigation"). BPCIA § 351(l)(6)(A); 42 U.S.C. § 262(l)(6)(A).

If the parties cannot agree on the patents to be litigated in the first round, they again exchange patent lists (the "separate lists for litigation"). Before the exchange of lists, the biosimilar applicant shall notify the reference-product sponsor of the number of patents it will list. BPCIA § 351(l)(5)(A); 42 U.S.C. § 262(l)(5)(A). Then, with-

15. It appears that the section is written to bind both the reference-product sponsor and any third party who had granted an exclusive license to the patent owner. § 271(e)(6)(C).

in five days of providing this number, the parties simultaneously exchange their respective lists of patents that they believe should be the subject of immediate litigation. BPCIA § 351(l)(5)(B); 42 U.S.C. § 262(l)(5)(B). The reference-patent sponsor may not include more patents on its list than the applicant includes, except in the case where the applicant includes none. Where the applicant includes none, the reference-product sponsor may include one. BPCIA § 351(l)(5)(B); 42 U.S.C. § 262(l)(5)(B).

10.3.3.5 Litigation of the First-Phase Patents

The reference-product sponsor shall, within thirty days of the final patent list exchange, bring an infringement action with respect to each patent included on the agreed or separate list for litigation. BPCIA § 351(l)(6)(B); 42 U.S.C. § 262(l)(6)(B).

The biosimilar applicant shall then provide the complaint to the FDA, which is published in the Federal Register. BPCIA § 351(l)(6)(C); 42 U.S.C. § 262(l)(6)(C). If the applicant fails to do so, the reference-product sponsor may bring an immediate declaratory judgment action on any of the patents in its initial or supplemental patent lists. BPCIA § 351(l)(9)(B); 42 U.S.C. § 262(l)(9)(B).

10.3.3.6 Notice of Commercial Marketing and Second Phase of Litigation

Not later than 180 days before “the first commercial marketing of the biological product licensed under subsection (k),” the applicant shall provide the reference-product sponsor with notice of intent to market the biosimilar. BPCIA § 351(l)(8); 42 U.S.C. § 262(l)(8). The reference-product sponsor may then initiate a second phase of litigation. In this action, the reference-product sponsor may seek a preliminary injunction on patents included in the reference-product sponsor’s initial list, but not included in the lists of patents to be litigated that were exchanged by the parties. BPCIA § 351(l)(8)(B); 42 U.S.C. § 262(l)(8)(B).

The timing of the second phase of litigation has been disputed. The statute provides that the notice should come “not later than” 180 days before commercial marketing; thus, there is a question whether the biosimilar applicant can provide the notice years before any product is actually sold and potentially disrupt the statutory litigation scheme.

This question arose at the district court level in *Sandoz Inc. v. Amgen Inc.*, 2013 WL 6000069 (N.D. Cal. Nov. 12, 2013), a patent infringement matter concerning the biologic etanercept. In that matter, the biosimilar applicant argued that the statute permitted it to provide a notice of commercial marketing and bring a declaratory judgment action, prior to submitting its § 351(k) application. *Id.* at *2. In this manner, it essentially bypassed the prelitigation procedures of § 351(l) altogether. *See id.* The district court disagreed, finding that the notice of commercial marketing did not properly issue because the product was not “licensed under subsection (k),” as required by the statutory provision. *Id.* In other words, the district court found that the notice can only issue after the FDA approves the biosimilar product. *See id.* Because the biosimilar cannot be approved until the end of the exclusivity period, this approach arguably may have the effect of adding an additional six months before the biosimilar

applicant may market its product. *See id.* at *2.¹⁶ The Federal Circuit did not address the issue on review. *Sandoz Inc. v. Amgen Inc.*, 773 F.3d 1274 (Fed. Cir. 2014).

Recently, however, the Federal Circuit had another opportunity to address this question in a different matter involving these same parties. In *Amgen Inc.*, 794 F.3d at 1357–58, the Federal Circuit held the notice of commercial marketing is effective only after licensure of the biosimilar, and that such notice is mandatory under the BPCIA (see discussion in § 10.3.4).

10.3.3.7 Remedies

Assuming that the prelitigation procedures are invoked, the remedies available to the reference-product sponsor in the event of a finding of infringement and validity will depend upon the reference-product sponsor's compliance with the prelitigation provisions. As discussed above, if the reference-product sponsor fails to include a patent in its initial list, suit by the patent owner on that patent will be barred. § 271(e)(6)(C).¹⁷

If a patent was included in the agreed or separate lists for litigation, and the reference-product sponsor brought suit on the patent within thirty days of the production of the lists, injunctive relief is available. Where there has been a final court decision of infringement and validity, and the exclusivity period for the reference-product has not yet expired, injunctive relief is mandatory. § 271(e)(4)(D).

If the patent owner does not bring suit within thirty days on a patent included in the separate or agreed lists for litigation, the patent owner may only seek a reasonable royalty as to those patents, and injunctive relief is not available. § 271(e)(6)(B). Likewise, only a reasonable royalty may be recovered if an action on such patents was dismissed without prejudice or was not prosecuted in good faith. *Id.*

10.3.4 Current Cases Testing the Boundaries of the BPCIA Prelitigation Procedures

At the time of writing, only a handful of cases have addressed the BPCIA's prelitigation procedures.

The first case on the BPCIA's prelitigation provisions considered by the Federal Circuit was *Sandoz Inc. v. Amgen Inc.*, 773 F.3d 1274 (Fed. Cir. 2014). As discussed above, in this matter, a § 351(k) applicant, before filing its biosimilar application, brought an action for declaratory judgment on patents potentially covering its biosimilar product. At the time it filed suit, biosimilar applicant Sandoz was in clinical trials to test a biologic containing etanercept. Etanercept is the nonproprietary name for Amgen's product Enbrel, a human tumor necrosis factor receptor. Sandoz argued

16. The district court also rejected the biosimilar's attempt to bring a declaratory judgment action on a number of other bases.

17. The language of the statute suggests that the patent owner will be barred even if the owner is not the reference-product sponsor, but the reference-product sponsor is instead an exclusive licensee.

that it intended to file a § 351(k) application for its etanercept product as a biosimilar to Enbrel at the conclusion of clinical trials.

Amgen moved to dismiss on the basis that the action was barred both by the Article III case-and-controversy requirement and by the provisions of the BPCIA. The district court agreed on both points. *Sandoz Inc. v. Amgen Inc.*, 2013 WL 6000069 at *1 (N.D. Cal. Nov. 12, 2013). The district court found that there was no case or controversy because Amgen had never threatened to sue Sandoz, and Sandoz's intent to file an application with the FDA was insufficient to create a case or controversy between the parties. *Id.* at *2. It also found that a biosimilar applicant is not entitled to bring a declaratory judgment action under the BPCIA until it has complied with its obligation to participate in the initial prelitigation exchange of information. *Id.*

The Federal Circuit affirmed, but did not address the district court's interpretation of the BPCIA. Instead, it addressed whether, on the facts presented, Sandoz showed a case or controversy. It found that Sandoz had not, pointing to the lack of a § 351(k) application, as well as the potential for failure of Sandoz's clinical trial. It also raised the possibility that, particularly if the clinical trial failed, the content of the potential application could change, affecting the content of any patent dispute. *Sandoz Inc. v. Amgen Inc.*, 773 F.3d at 1280. The Federal Circuit also noted that Sandoz failed to show any immediate adverse impact from not being able to pursue its declaratory judgment action. *Id.* at 1281–82.

In two other cases predating the Federal Circuit's opinion in the *Sandoz* matter by a few days, the Southern District of New York considered similar issues in a similar factual posture. In the first matter, *Celltrion Healthcare Co., Ltd. v. Kennedy Trust for Rheumatology Research*, the court evaluated a motion to dismiss a declaratory judgment action brought by a biosimilar applicant that had not, at the time it filed its complaint, yet submitted its § 351(k) application. Opinion & Order (S.D.N.Y. Dec. 1, 2014), Case No. 14 Civ. 2256 (PAC) (Dkt. No. 32). However, in contrast to the *Sandoz* matter, the biosimilar applicant sued not the reference-product sponsor, but the patent holder that had granted an exclusive license to the reference-product sponsor. *Id.* at 9. The district court found that this was a distinction without difference for purposes of the application of the BPCIA's patent litigation procedures. *Id.*

The district court ultimately held, consistent with the Federal Circuit's opinion in the *Sandoz* matter, no case or controversy under Article III. *Id.* at 8. The district court also considered the BPCIA and whether its prelitigation procedures barred the suit. The court stopped short of finding that the BPCIA categorically foreclosed the lawsuit. It held only that, if a case or controversy existed, it would exercise its discretion not to consider it, given that doing so would be contrary to the complex statutory structure and goals of the BPCIA.

In the related *Hospira, Inc. v. Janssen Biotech, Inc.* matter, the same district court considered the situation in which the coexclusive marketer of the Celltrion biosimilar brought a declaratory judgment action against the reference-product sponsor. Opinion & Order (S.D.N.Y. Dec. 1, 2014), Case No. 14 Civ. 7049 (PAC) (Dkt. No. 60). The district court dismissed this action on the same basis, finding that Hospira, despite not being the § 351(k) applicant, "seeks to utilize the BPCIA pathway for approval of its biosimilar drug, yet disavows the BPCIA's authority over patent disputes." *Id.* at 3.

It was not long before the Federal Circuit addressed the BPCIA prelitigation provisions head on. In another case involving Amgen and Sandoz—this time relating to Amgen’s Neupogen (filgrastim) product—Sandoz submitted a § 351(k) application to FDA but did not provide a copy of its application and manufacturing process information to Amgen. Instead, Sandoz provided notice of its intent to market the biosimilar prior to the biosimilar’s approval by the FDA.¹⁸ In response, Amgen brought claims alleging violation of California’s Unfair Competition Law (“UCL”), conversion, and patent infringement. Amgen argued that Sandoz’s failure to comply with the statute’s prelitigation procedures and its notice of intent to market prior to receiving approval from the FDA amounted to unlawful conduct sufficient to invoke the UCL. Amgen also argued that Sandoz’s reliance on Amgen’s FDA license for the reference product, without compliance with the statutory prelitigation procedures, constituted a “wrongful act” sufficient to maintain a claim for conversion.

The district court dismissed Amgen’s UCL and conversion claims, finding that Sandoz was entitled under the statute to decline to follow the prelitigation procedures. *Amgen Inc. v. Sandoz Inc.*, Case No. 14-cv-04741-RS, 2015 WL 1264756, at *11 (N.D. Cal. Mar. 19, 2015). The court found that the statutory provisions, rather than setting out mandatory prelitigation procedures, set out a system providing two potential pathways, each with potential costs and benefits. *Id.* at *3. The district court also found that Sandoz’s decision to provide notice of intent to market prior to approval by the FDA was permissible, as to hold otherwise would “tack an unconditional extra six months of market exclusivity onto the twelve years reference-product sponsors already enjoy under 42 U.S.C. § 262(k)(7)(A).” *Id.* at *8. Amgen appealed.

In a fractured opinion, the Federal Circuit affirmed in part and reversed in part the district court’s decision. First, the court agreed that the BPCIA’s exchange-of-information provisions are not mandatory, and thus a biosimilar applicant may choose whether to follow the prelitigation procedures in § 351(l). *Amgen Inc.*, 794 F.3d at 1354–57. The court noted that, when read in isolation, the “shall” provision in § 351(l)(2)(A) appeared to mean that a biosimilar applicant “must” disclose its application and manufacturing information to the reference-product sponsor by the statutory deadline. *Id.* at 1355. However, because the BPCIA expressly contemplates that a biosimilar applicant might fail to do this and provides a consequence for such a failure—that is, the reference-product sponsor, but not the biosimilar applicant, may bring a declaratory judgment action for patent infringement—the “shall” in § 351(l)(2)(A) does not mean “must” and the biosimilar applicant has the option of whether to engage in the BPCIA’s prelitigation exchange-of-information procedures. *Id.* at 1355–56. The court affirmed the dismissal of Amgen’s UCL and conversion claims on this ground. *Id.* at 1360–61.

Second, the Federal Circuit reversed the district’s court ruling on the BPCIA’s 180-day intent-to-market notification requirement, holding that a biosimilar applicant can provide effective notice of commercial marketing to the reference-product

18. On March 6, 2015, the FDA approved Sandoz’s biosimilar application for Zarxio (filgrastim-sndz).

sponsor only after the biosimilar has been licensed by FDA. *Id.* at 1357–58. The court found instructive that the BPCIA’s 180-day notification provision in § 351(l)(8)(A) refers to the product as “the biological product licensed under subsection (k),” rather than “the biological product that is the subject of the application,” as the BPCIA does in other provisions in subsection (l). *Id.* The court also noted that it would be “counterintuitive to provide that notice of commercial marketing be given at a time before one knows when, or if, the product will be approved, or licensed.” *Id.* at 1358. In contrast to its holding with respect to the prelitigation exchange-of-information procedures, the court held that the 180-day intent-to-market notification is mandatory under the BPCIA. *Id.*

Judge Newman concurred in part and dissented in part, agreeing that the 180-day notice is mandatory and must occur after licensure, but disagreeing that the BPCIA’s prelitigation exchange-of-information procedures are optional. *Id.* at 1363. According to Judge Newman, “[t]his designated exchange of information is fundamental to the BPCIA purposes of efficient resolution of patent issues,” and a biosimilar applicant must comply with these provisions. *Id.* at *1364. Judge Chen dissented in part, explaining that the 180-day marketing notification should not be read as a standalone provision, but rather as part of the optional procedures set forth in § 351(l). *Id.* at 1367–70. Similar to the district court’s reasoning, Judge Chen concluded that to read the provision otherwise would afford reference-product sponsors “an inherent right to an automatic 180-day injunction,” *id.* at 1370, and “an extra-statutory exclusivity windfall,” *id.* at 1371. Petitions for certiorari were filed in early 2016 in this case.

On July 5, 2016, the Federal Circuit ruled in *Amgen Inc. v. Apotex Inc.* that all § 262(k) applicants must provide reference product sponsors with 180 days’ notice under § 262(l)(8)(A) before commercially marketing a biosimilar product, regardless of whether the § 262(k) applicant provided the reference product sponsor with notice of FDA review under § 262(l)(2). No. 16-1308, ___ F.3d ___ (Fed. Cir. 2016). As noted above, the Federal Circuit had made clear in *Amgen v. Sandoz* that § 262(l)(8)(A) notice is mandatory when a § 262(k) applicant elects to not provide the required § 262(l)(2) notice, and furthermore that issuance of the commercial marketing notice under § 262(l)(8)(A) starting the 180-day clock must follow licensure. 794 F.3d at 1357–58. Now, the Federal Circuit has determined that “the commercial marketing provision [outlined in § 262(l)(8)(A)] is mandatory and enforceable by injunction even for an applicant” who has followed the steps outlined in § 262(l), including notice under § 262(l)(2). *Amgen Inc. v. Apotex Inc.*, No. 16-1308, ___ F.3d ___ (Fed. Cir. 2016) (slip op. at 4). In addition, the court rejected the argument that a declaratory judgment action is the exclusive remedy for a § 262(l)(8)(A) violation, based on the provisions of § 262(l)(9)(B). *Id.* at 21. Therefore, courts may grant injunctive relief to prevent a § 262(k) applicant from entering the market until (1) it has provided the reference product sponsor with notice after the FDA has issued the relevant license under § 262(l)(8)(A) violation, and (2) it has then waited 180 days. *Id.* at 25.

It is very likely that, in the coming months, additional relevant case law will develop as more § 351(k) applications are submitted and more disputes arise.

Appendix 10.1

Glossary of Hatch-Waxman Related Terms

180-day exclusive marketing period: The period awarded to certain ANDA filers as a reward for successfully challenging a patent holder's claim that marketing a drug would infringe the patent holder's Orange Book-listed patent. § 10.1.2.

abbreviated new drug application (ANDA): The FDA application filed by a generic drug manufacturer seeking approval to market a follow-on drug by showing it is the same as a Reference Listed Drug, and relying on the clinical trial and other safety and efficacy data submitted by the original drug filer in its New Drug Application. § 10.1.

artificial act of infringement: Filing a Paragraph IV certification in an ANDA application stating that an NDA-holder's listed patent will not be infringed or is invalid. § 10.1.

at-risk launch: Commencing marketing a generic drug pursuant to a finally-approved ANDA before litigation is final. § 10.1.

carve-out: A statement by an ANDA filer that it seeks to market the drug only for uses not encompassed by the use code descriptions of patents listed by the NDA holder in the Orange Book. Same as a *Section (viii) statement*. § 10.1.

civil action to obtain patent certainty (CAPC): A declaratory judgment counterclaim brought by an ANDA applicant seeking a judgment that a patent listed by the NDA holder in the Orange Book, but not sued on by the NDA holder, is invalid, unenforceable or not infringed. § 10.2.2.2.

final approval: FDA approval to begin commercial sales of a regulated drug. § 10.1.1.

new chemical entity (NCE): A chemical compound not previously approved for marketing by the FDA. § 10.1.1.

new drug application (NDA): The drug application filed by a pharmaceutical company seeking approval to market a new drug, and supported by clinical trials showing the drug's safety and efficacy. § 10.1.

offer for confidential access: An offer by a generic drug manufacturer to an NDA holder to allow the NDA holder to review the generic company's ANDA in order to determine whether the NDA holder wishes to file a suit asserting infringement of its patents. § 10.2.2.2.

Orange Book: The FDA publication and online website containing NDA patent owners' claimed patents covering each drug or its uses. § 10.1.1.

Paragraph IV certification: A statement in an ANDA that the generic drug infringes no Orange Book-listed patent, or that the listed patents are invalid. § 10.1.1.

pop-up patent: A patent added by an NDA holder to its Orange Book listing of patents after the date the relevant ANDA was filed. § 10.1.1.

reference listed drug (RLD): An innovative drug approved by the FDA pursuant to an NDA based on the applicants' human clinical trials. § 10.1.

reverse payments: Payments by an NDA holder to a generic drug company as part of a settlement in which the generic drug company agrees to withhold marketing its drug for a period. § 10.2.4.1.

Section (viii) statement: Same as a *carve-out*, above. § 10.1.

tentative approval: Substantive approval by FDA to market a generic drug, but precluding commercial sales of the drug until termination of patent (Paragraph III certification), expiration of thirty-month period (if Paragraph IV certification and litigation within 45-day window), expiration of 180-day exclusivity of prior ANDA filer, or expiration of a period of exclusivity for the brand name drug (*e.g.*, New Chemical Entity). § 10.1.

use code/use code description: a description filed by an NDA holder of which FDA-approved uses or indications of the drug are encompassed by an Orange-Book listed method of use patent. § 10.1.1.

Appendix 10.2

ANDA Scheduling Order from Chief Judge Stark

REVISED July 1, 2014

REVISED PATENT FORM SCHEDULING ORDER (ANDA)

[NOTE: text in brackets is for guidance and should be deleted from proposed schedules submitted for the Court's consideration]

This ___ day of _____, 201_, the Court having conducted a Case Management Conference/Rule 16 scheduling and planning conference pursuant to Local Rule 16.2(a) and Judge Stark's Revised Procedures for Managing Patent Cases (which is posted at <http://www.ded.uscourts.gov>; see Chambers, Judge Leonard P. Stark, Patent Cases) on _____ 201_, and the parties having determined after discussion that the matter cannot be resolved at this juncture by settlement, voluntary mediation, or binding arbitration;

IT IS HEREBY ORDERED that:

1. Rule 26(a)(1) Initial Disclosures and E-Discovery Default Standard. Unless otherwise agreed to by the parties, the parties shall make their initial disclosures pursuant to Federal Rule of Civil Procedure 26(a)(1) within five (5) days of the date of this Order. If they have not already done so, the parties are to review the Court's Default Standard for Discovery, Including Discovery of Electronically Stored Information ("ESI") (which is posted at <http://www.ded.uscourts.gov>; see Other Resources, Default Standards for Discovery, and is incorporated herein by reference).

2. Joinder of Other Parties and Amendment of Pleadings. All motions to join other parties, and to amend or supplement the pleadings, shall be filed on or before _____, 201_.

3. Application to Court for Protective Order. Should counsel find it will be necessary to apply to the Court for a protective order specifying terms and conditions for the disclosure of confidential information, counsel should confer and attempt to reach an agreement on a proposed form of order and submit it to the Court within ten (10) days from the date of this Order. Should counsel be unable to reach an agreement on a proposed form of order, counsel must follow the provisions of Paragraph 8(g) below.

Any proposed protective order must include the following paragraph:

Other Proceedings. By entering this order and limiting the disclosure of information in this case, the Court does not intend to preclude another court from finding that information may be relevant and subject to disclosure in another case. Any person or party subject to this order who becomes subject to a motion to disclose another party's information designated "confidential" [the parties should list any other level of designation, such as "highly confidential," which may be provided for in the protective order] pursuant to this order shall promptly notify that party of the motion so that the party may have an opportunity to appear and be heard on whether that information should be disclosed.

4. Papers Filed Under Seal. In accordance with section G of the Administrative Procedures Governing Filing and Service by Electronic Means, a redacted version of any sealed document shall be filed electronically within seven (7) days of the filing of the sealed document.

Should any party intend to request to seal or redact all or any portion of a transcript of a court proceeding (including a teleconference), such party should expressly note that intent at the start of the court proceeding. Should the party subsequently choose to make a request for sealing or redaction, it must, promptly after the completion of the transcript, file with the Court a motion for sealing/redaction, and include as attachments (1) a copy of the complete transcript highlighted so the Court can easily identify and read the text proposed to be sealed/redacted, and (2) a copy of the proposed redacted/sealed transcript. With their request, the party seeking redactions must demonstrate why there is good cause for the redactions and why disclosure of the redacted material would work a clearly defined and serious injury to the party seeking redaction.

5. Courtesy Copies. Other than with respect to “discovery matters,” which are governed by paragraph 8(g), and the final pretrial order, which is governed by paragraph 20, the parties shall provide to the Court two (2) courtesy copies of all briefs and one (1) courtesy copy of any other document filed in support of any briefs (i.e., appendices, exhibits, declarations, affidavits etc.). This provision also applies to papers filed under seal.

6. ADR Process. This matter is referred to a magistrate judge to explore the possibility of alternative dispute resolution.

7. Discovery. Unless otherwise ordered by the Court, the limitations on discovery set forth in Local Rule 26.1 shall be strictly observed.

a. Discovery Cut Off. All discovery in this case shall be initiated so that it will be completed on or before _____, 201_.

b. Document Production. Document production shall be substantially complete by _____, 201_.

c. Requests for Admission. A maximum of ___ requests for admission are permitted for each side.

d. Interrogatories.

i. A maximum of ___ interrogatories, including contention interrogatories, are permitted for each side.

ii. The Court encourages the parties to serve and respond to contention interrogatories early in the case. In the absence of agreement among the parties, contention interrogatories, if filed, shall first be addressed by the party with the burden of proof. The adequacy of all interrogatory answers shall be judged by the level of detail each party provides; i.e., the more detail a party provides, the more detail a party shall receive.

e. Depositions.

i. Limitation on Hours for Deposition Discovery. Each side is limited to a total of ___ hours of taking testimony by deposition upon oral examination.

ii. Location of Depositions. Any party or representative (officer, director, or managing agent) of a party filing a civil action in this district court must ordinarily

be required, upon request, to submit to a deposition at a place designated within this district. Exceptions to this general rule may be made by order of the Court. A defendant who becomes a counterclaimant, cross-claimant, or third-party plaintiff shall be considered as having filed an action in this Court for the purpose of this provision.

f. Disclosure of Expert Testimony.

i. Expert Reports. For the party who has the initial burden of proof on the subject matter, the initial Federal Rule 26(a)(2) disclosure of expert testimony is due on or before _____, 201_. The supplemental disclosure to contradict or rebut evidence on the same matter identified by another party is due on or before _____, 201_. Reply expert reports from the party with the initial burden of proof are due on or before _____, 201_. No other expert reports will be permitted without either the consent of all parties or leave of the Court. Along with the submissions of the expert reports, the parties shall advise of the dates and times of their experts' availability for deposition.

ii. Expert Report Supplementation. The parties agree they [will] [will not] [CHOOSE ONE] permit expert declarations to be filed in connection with motions briefing (including case-dispositive motions).

iii. Objections to Expert Testimony. To the extent any objection to expert testimony is made pursuant to the principles announced in *Daubert v. Merrell Dow Pharm., Inc.*, 509 U.S. 579 (1993), as incorporated in Federal Rule of Evidence 702, it shall be made by motion no later than the deadline for dispositive motions set forth herein, unless otherwise ordered by the Court. Briefing on such motions is subject to the page limits set out in connection with briefing of case dispositive motions.

g. Discovery Matters and Disputes Relating to Protective Orders.

i. Any discovery motion filed without first complying with the following procedures will be denied without prejudice to renew pursuant to these procedures.

ii. Should counsel find, after good faith efforts—including verbal communication among Delaware and Lead Counsel for all parties to the dispute—that they are unable to resolve a discovery matter or a dispute relating to a protective order, the parties involved in the discovery matter or protective order dispute shall submit a joint letter in substantially the following form:

Dear Judge Stark:

The parties in the above- referenced matter write to request the scheduling of a discovery teleconference.

The following attorneys, including at least one Delaware Counsel and at least one Lead Counsel per party, participated in a verbal meet-and-confer (in person and/or by telephone) on the following date(s): _____

Delaware Counsel: _____

Lead Counsel: _____

The disputes requiring judicial attention are listed below:

[provide here a non-argumentative list of disputes requiring judicial attention]

iii. On a date to be set by separate order, generally not less than forty-eight (48) hours prior to the conference, the party seeking relief shall file with the Court a letter, not to exceed three (3) pages, outlining the issues in dispute and its position on those issues. On a date to be set by separate order, but generally not less than twenty-four (24) hours prior to the conference, any party opposing the application for relief may file a letter, not to exceed three (3) pages, outlining that party's reasons for its opposition.

iv. Each party shall submit two (2) courtesy copies of its discovery letter and any attachments.

v. Should the Court find further briefing necessary upon conclusion of the telephone conference, the Court will order it. Alternatively, the Court may choose to resolve the dispute prior to the telephone conference and will, in that event, cancel the conference.

8. Motions to Amend.

a. Any motion to amend (including a motion for leave to amend) a pleading shall NOT be accompanied by an opening brief but shall, instead, be accompanied by a letter, not to exceed three (3) pages, describing the basis for the requested relief, and shall attach the proposed amended pleading as well as a "blackline" comparison to the prior pleading.

b. Within seven (7) days after the filing of a motion in compliance with this Order, any party opposing such a motion shall file a responsive letter, not to exceed five (5) pages.

c. Within three (3) days thereafter, the moving party may file a reply letter, not to exceed two (2) pages, and, by this same date, the parties shall file a letter requesting a teleconference to address the motion to amend.

9. Motions to Strike.

a. Any motion to strike any pleading or other document shall NOT be accompanied by an opening brief but shall, instead, be accompanied by a letter, not to exceed three (3) pages, describing the basis for the requested relief, and shall attach the document to be stricken.

b. Within seven (7) days after the filing of a motion in compliance with this Order, any party opposing such a motion shall file a responsive letter, not to exceed five (5) pages.

c. Within three (3) days thereafter, the moving party may file a reply letter, not to exceed two (2) pages, and, by this same date, the parties shall file a letter requesting a teleconference to address the motion to strike.

10. Tutorial Describing the Technology and Matters in Issue. Unless otherwise ordered by the Court, the parties shall provide the Court, no later than the date on which their opening claim-construction briefs are due, a tutorial on the technology at issue. In that regard, the parties may separately or jointly submit a DVD of not more than thirty (30) minutes. The tutorial should focus on the technology in issue and should not be used for argument. The parties may choose to file their tutorial(s)

under seal, subject to any protective order in effect. Each party may comment, in writing (in no more than five (5) pages) on the opposing party's tutorial. Any such comment shall be filed no later than the date on which the answering claim-construction briefs are due. As to the format selected, the parties should confirm the Court's technical abilities to access the information contained in the tutorial (currently best are "mpeg" or "quicktime").

11. Claim Construction Issue Identification. On _____, 201_, the parties shall exchange a list of those claim term(s)/phrase(s) that they believe need construction and their proposed claim construction of those term(s)/phrase(s). This document will not be filed with the Court. Subsequent to exchanging that list, the parties will meet and confer to prepare a Joint Claim Construction Chart to be submitted on _____, 201_. The parties' Joint Claim Construction Chart should identify for the Court the term(s)/phrase(s) of the claim(s) in issue, and should include each party's proposed construction of the disputed claim language with citation(s) only to the intrinsic evidence in support of their respective proposed constructions. A copy of the patent(s) in issue as well as those portions of the intrinsic record relied upon shall be submitted with this Joint Claim Construction Chart. In this joint submission, the parties shall not provide argument.

12. Claim Construction Briefing. The parties shall contemporaneously submit initial briefs on claim construction issues on _____, 201_. The parties' answering/responsive briefs shall be contemporaneously submitted on _____, 201_. No reply briefs or supplemental papers on claim construction shall be submitted without leave of the Court. Local Rule 7.1.3(4) shall control the page limitations for initial (opening) and responsive (answering) briefs.

13. Hearing on Claim Construction. Beginning at _____ .m. on _____, 201_, the Court will hear argument on claim construction. The parties shall notify the Court, by joint letter submission, no later than the date on which their answering claim construction briefs are due: (i) whether they request leave to present testimony at the hearing; and (ii) the amount of time they are requesting be allocated to them for the hearing.

Provided that the parties comply with all portions of this Scheduling Order, and any other orders of the Court, the parties should anticipate that the Court will issue its claim construction order within sixty (60) days of the conclusion of the claim construction hearing. If the Court is unable to meet this goal, it will advise the parties no later than sixty (60) days after the conclusion of the claim construction hearing.

14. Interim Status Report. On _____, 201_, counsel shall submit a joint letter to the Court with an interim report on the nature of the matters in issue and the progress of discovery to date. Thereafter, if the Court deems it necessary, it will schedule a status conference.

15. Supplementation. Absent agreement among the parties, and approval of the Court, no later than the parties must finally supplement, *inter alia*, the identification of all accused products and of all invalidity references.

16. Case Dispositive Motions. [Absent agreement between the parties, the Court will generally not hear case dispositive motions in ANDA cases.]

17. Applications by Motion. Except as otherwise specified herein, any application to the Court shall be by written motion filed with the Clerk. Any non-dispositive motion should contain the statement required by Local Rule 7.1.1.

18. Pretrial Conference. On _____, 201_, the Court will hold a pretrial conference in Court with counsel beginning at _____ m. [The parties should request a date approximately 2–4 weeks prior to their requested trial date.] Unless otherwise ordered by the Court, the parties should assume that filing the pretrial order satisfies the pretrial disclosure requirement of Federal Rule of Civil Procedure 26(a)(3). The parties shall file with the Court the joint proposed final pretrial order with the information required by the form of Revised Final Pretrial Order – Patent, which can be found on the Court’s website (www.ded.uscourts.gov), on or before _____, 201_. [The parties should insert a date no less than seven (7) days before the requested pretrial conference date.] Unless otherwise ordered by the Court, the parties shall comply with the timeframes set forth in Local Rule 16.3(d)(1)–(3) for the preparation of the joint proposed final pretrial order.

The parties shall provide the Court two (2) courtesy copies of the joint proposed final pretrial order and all attachments.

As noted in the Revised Final Pretrial Order – Patent, the parties shall include in their joint proposed final pretrial order, among other things:

a request for a specific number of hours for their trial presentations, as well as a requested number of days, based on the assumption that in a typical bench trial day there will be 6 to 7 hours of trial time;

their position as to whether the Court should allow objections to efforts to impeach a witness with prior testimony, including objections based on lack of completeness and/or lack of inconsistency;

their position as to whether the Court should rule at trial on objections to expert testimony as beyond the scope of prior expert disclosures, taking time from the parties; trial presentation to argue and decide such objections, or defer ruling on all such objections unless renewed in writing following trial, subject to the proviso that a party prevailing on such a post-trial objection will be entitled to have all of its costs associated with a new trial paid for by the party that elicited the improper expert testimony at the earlier trial; and

their position as to how to make motions for judgment as a matter of law, whether it be immediately at the appropriate point during trial or at a subsequent break and whether such motions may be supplemented in writing.

19. Motions in Limine. Motions *in limine* shall not be separately filed. All *in limine* requests and responses thereto shall be set forth in the proposed pretrial order. Each **SIDE** shall be limited to three (3) *in limine* requests, unless otherwise permitted by the Court. The *in limine* request and any response shall contain the authorities relied upon; each *in limine* request may be supported by a maximum of three (3) pages of argument and may be opposed by a maximum of three (3) pages of argument, and the side making the *in limine* request may add a maximum of one (1) additional page in reply in support of its request. If more than one party is supporting or opposing an *in limine* request, such support or opposition shall be combined in a single three (3) page submission (and, if the moving party, a single one (1) page

reply), unless otherwise ordered by the Court. No separate briefing shall be submitted on *in limine* requests, unless otherwise permitted by the Court.

20. Trial. This matter is scheduled for a ___ day bench trial beginning at 8:30 a.m. on _____, 201_, with the subsequent trial days also beginning at 8:30 a.m. The trial day will end no later than 5:00 p.m. each day.

21. Post-Trial Briefing. The parties will address the post-trial briefing schedule and page limits in the proposed final pretrial order.

UNITED STATES DISTRICT JUDGE

Appendix 10.3

ANDA-Specific Local Patent Rules

United States District Court: District of New Jersey Local Patent Rule 3.6

3.6 Disclosure Requirements for Patent Cases Arising Under 21 U.S.C. § 355 (commonly referred to as “the Hatch-Waxman Act”).

The following applies to all patents subject to a Paragraph IV certification in cases arising under 21 U.S.C. § 355 (commonly referred to as “the Hatch-Waxman Act”). This rule takes precedence over any conflicting provisions in L. Pat. R. 3.1 to 3.5 for all cases arising under 21 U.S.C. § 355.

(a) On the date a party answers, moves, or otherwise responds, each party who is an ANDA filer shall produce to each party asserting patent infringement the entire Abbreviated New Drug Application or New Drug Application that is the basis of the case in question.

(b) Not more than seven days after the initial Scheduling Conference, each party asserting patent infringement shall serve on all parties a “Disclosure of Asserted Claims” that lists each claim of each patent that is allegedly infringed by each opposing party, including for each claim the applicable statutory subsections of 35 U.S.C. § 271 asserted.

(c) Not more than 14 days after the initial Scheduling Conference, each party opposing an assertion of patent infringement shall provide to each party asserting patent infringement the written basis for its “Invalidity Contentions,” for any patents referred to in the opposing party’s Paragraph IV Certification, which shall contain all disclosures required by L. Pat. R. 3.3.

(d) Any “Invalidity Contentions” disclosed under L. Pat. R. 3.6(c), shall be accompanied by the production of documents required under L. Pat. R. 3.4(b) and (c).

(e) Not more than 14 days after the initial Scheduling Conference, each party opposing an assertion of patent infringement shall provide to each party asserting patent infringement the written basis for its “Non-Infringement Contentions,” for any patents referred to in the opposing party’s Paragraph IV Certification which shall include a claim chart identifying each claim at issue in the case and each limitation of each claim at issue. The claim chart shall specifically identify for each claim which claim limitation(s) is/(are) literally absent from each opposing party’s allegedly infringing Abbreviated New Drug Application or New Drug Application.

(f) Any “Non-Infringement Contentions” disclosed under L. Pat. R. 3.6(e), shall be accompanied by the production of any document or thing that each party who is an ANDA filer intends to rely on in defense against any infringement contentions by each party asserting patent infringement.

(g) Not more than 45 days after the disclosure of the “Non-Infringement Contentions” as required by L. Pat. R. 3.6(e), each party asserting patent infringement shall provide each opposing party with a “Disclosure of Infringement Contentions,” for all patents referred to in each opposing party’s Paragraph IV Certification, which shall contain all disclosures required by L. Pat. R. 3.1. The infringement contentions shall be limited to the claims identified in L. Pat. R. 3.6(b).

(h) Any “Disclosure of Asserted Claims and Infringement Contentions” disclosed under L. Pat. R. 3.6(g), shall be accompanied by the production of documents required under L. Pat. R. 3.2.

(i) Not more than 45 days after the disclosure of “Invalidity Contentions” as required by L. Pat. R. 3.6(c), the party defending the validity of the patent shall serve on each other party its “Responses to Invalidity Contentions” as required under L. Pat. R. 3.4A.

(j) Each party that has an ANDA application pending with the Food and Drug Administration (“FDA”) that is the basis of the pending case shall: (1) notify the FDA of any and all motions for injunctive relief no later than three business days after the date on which such a motion is filed; and (2) provide a copy of all correspondence between itself and the FDA pertaining to the ANDA application to each party asserting infringement, or set forth the basis of any claim of privilege for such correspondence pursuant to L. Civ. R. 34.1, no later than seven days after the date it sends same to the FDA or receives same from the FDA.

United States District Court for the Eastern District of Texas Patent Rule 3-8

3-8. Disclosure Requirements for Patent Cases Arising Under 21 U.S.C. § 355 (Hatch-Waxman Act).

The following provision applies to all patents subject to a Paragraph IV certification in cases arising under 21 U.S.C. § 355 (commonly referred to as “the Hatch-Waxman Act”). This provision takes precedence over any conflicting provisions in P.R. 3-1 to 3-5 for all cases arising under 21 U.S.C. § 355.

(a) At or before the Initial Case Management Conference, the Defendant(s) shall produce to Plaintiff(s) the entire Abbreviated New Drug Application or New Drug Application that is the basis of the case in question.

(b) Not more than 14 days after the Initial Case Management Conference, the Defendant(s) shall provide to Plaintiff(s) the written basis for their “Invalidity Contentions” for any patents referred to in Defendant(s) Paragraph IV Certification. This written basis shall contain all disclosures required by P.R. 3-3 and shall be accompanied by the production of documents required by P.R. 3-4.

(c) Not more than 14 days after the Initial Case Management Conference, the Defendant(s) shall provide to Plaintiff(s) the written basis for any defense of noninfringement for any patent referred to in Defendant(s) Paragraph IV Certification. This written basis shall include a claim chart identifying each claim at issue in the case and each limitation of each claim at issue. The claim chart shall specifically identify for each claim those claim limitation(s) that are literally absent from the Defendant(s) allegedly infringing Abbreviated New Drug Application or New Drug Application. The written basis for any defense of noninfringement shall also be accompanied by the production of any document or thing that the Defendant(s) intend to rely upon in defense of any infringement allegations by Plaintiff(s).

(d) Not more than 45 days after the disclosure of the written basis for any defense of noninfringement as required by P.R. 3-8(c), Plaintiff(s) shall provide Defendant(s) with a “Disclosure of Asserted Claims and Infringement Contentions,” for all patents referred to in Defendant(s) Paragraph IV Certification, which shall

contain all disclosures required by P.R. 3-1 and shall be accompanied by the production of documents required by P.R. 3-2.

(e) Each party that has an ANDA application pending with the Food and Drug Administration (“FDA”) that is the basis of the pending case shall: (1) notify the FDA of any and all motions for injunctive relief no later than three business days after the date on which such a motion is filed; and (2) provide a copy of all correspondence between itself and the FDA pertaining to the ANDA application to each party asserting infringement, or set forth the basis of any claim of privilege for such correspondence, no later than seven days after the date it sends or receives any such correspondence.

Northern District of Ohio Local Patent Rule 3.9

3.9 Disclosure Requirements for Patent Cases Arising Under 21 U.S.C. § 355 (commonly referred to as “the Hatch-Waxman Act”).

The following provision applies to all patents subject to a Paragraph IV certification in cases arising under 21 U.S.C. § 355 (commonly referred to as “the Hatch-Waxman Act”). This provision takes precedence over any conflicting provisions in L. P. R. 3.1 to 3.8 for all cases arising under 21 U.S.C. § 355.

(a) At or before the Case Management Conference, the Defendant(s) shall produce to Plaintiff(s) the entire Abbreviated New Drug Application or New Drug Application that is the basis of the case in question.

(b) Not less than fifteen (15) calendar days after the Case Management Conference, the Defendant(s) shall provide to Plaintiff(s) written Invalidity Contentions, for any patents referred to in Defendant(s) Paragraph IV Certification. At a minimum, these Invalidity Contentions should include those items required by L. P. R. 3.5(a-d);

(c) Any Invalidity Contentions disclosed under L. P. R. 3.9(b) shall be accompanied by the production of any document or thing that each Defendant intends to rely on to show invalidity. At a minimum, this disclosure should comply with L. P. R. 3.6(a).

(d) Not less than thirty (30) calendar days after the Case Management Conference, the Defendant(s) shall provide to Plaintiff(s) the written basis for their Noninfringement Contentions for any patents referred to in Defendant(s) Paragraph IV Certification which shall include a claim chart as required by L. P. R. 3.3(a) identifying each claim at issue in the case and each limitation of each claim at issue. The claim chart shall specifically identify for each claim which claim limitation(s) are literally absent from the Defendant(s) allegedly infringing Abbreviated New Drug Application or New Drug Application

(e) Any Noninfringement Contentions disclosed under L. P. R. 3.9(d) shall be accompanied by the production of any document or thing that the Defendant(s) intend to rely on in defense against any infringement contentions by Plaintiff(s), including those items required by L. P. R. 3.4(a).

(f) Not less than forty-five (45) calendar days after the disclosure of the Noninfringement Contentions as required by L. P. R. 3.9(d), Plaintiff(s) shall provide Defendant(s) with Infringement Contentions for all patents referred to in Defendant(s)

Paragraph IV Certification, including, at a minimum, those items required by L. P. R. 3.1.

(g) Any Infringement Contentions disclosed under L. P. R. 3.9(f) shall be accompanied by the production of documents required under L. P. R. 3.2.

District of Idaho Local Patent Rule 3-6

3.6. Disclosure Requirements for Patent Cases Arising Under 21 U.S.C. § 355 (commonly referred to as “the Hatch-Waxman Act”).

The requirements of this Dist. Idaho Loc. Patent R. 3.6 apply to all patents subject to a Paragraph IV certification in cases arising under 21 U.S.C. § 355 (commonly referred to as “the Hatch-Waxman Act”). This provision takes precedence over any conflicting provisions in Dist. Idaho Loc. Patent R. 3.1 to 3.5 for all cases arising under 21 U.S.C. § 355.

(a) At or before the initial scheduling conference, the Defendant(s) shall produce to Plaintiff(s) the entire Abbreviated New Drug Application or New Drug Application that is the basis of the case in question.

(b) Not more than 14 days after the initial scheduling conference, the Defendant(s) shall provide to Plaintiff(s) the written basis for their “Invalidity Contentions,” for any patents referred to in Defendant(s) Paragraph IV Certification which shall contain all disclosures required by Dist. Idaho Loc. Patent R. 3.3.

(c) Any “Invalidity Contentions” disclosed under Dist. Idaho Loc. Patent R. 3-6(b), shall be accompanied by the production of documents required under Dist. Idaho Loc. Patent R. 3.4.

(d) Not more than 14 days after the initial scheduling conference, the Defendant(s) shall provide to Plaintiff(s) the written basis for their “Non-Infringement Contentions,” for any patents referred to in Defendant(s) Paragraph IV Certification which shall include a claim chart identifying each claim at issue in the case and each limitation of each claim at issue. The claim chart shall specifically identify for each claim which claim limitation(s) are literally absent from the Defendant(s) allegedly infringing Abbreviated New Drug Application or New Drug Application.

(e) Any “Non-Infringement Contentions” disclosed under Dist. Idaho Loc. Patent R. 3.6(d), shall be accompanied by the production of any document or thing that the Defendant(s) intend to rely on in defense against any infringement contentions by Plaintiff(s).

(f) Not more than 42 days after the disclosure of the “Non-Infringement Contentions” as required by Dist. Idaho Loc. Patent R. 3.6(d), Plaintiff(s) shall provide Defendant(s) with a “Disclosure of Asserted Claims and Infringement Contentions,” for all patents referred to in Defendant(s) Paragraph IV Certification, which shall contain all disclosures required by Dist. Idaho Loc. Patent R. 3.1.

(g) Any “Disclosure of Asserted Claims and Infringement Contentions” disclosed under Dist. Idaho Loc. Patent R. 3.6(f), shall be accompanied by the production of documents required under Dist. Idaho Loc. Patent R. 3.2.

District of Maryland Patent Local Rule 805.3

3. Cases Arising Under the Hatch-Waxman Act (21 U.S.C. § 355)

Unless otherwise ordered by the Court, in all cases alleging patent infringement based upon a Paragraph IV certification under 21 U.S.C. § 355:

a. Sixty (60) days from the date of the Scheduling Order, the Defendant shall serve the Plaintiff with a Claim Chart containing the following:

i. The identity of each item of prior art that allegedly anticipates each asserted claim or renders it obvious. Each prior art patent shall be identified by its number, country of origin, and date of issue. Each prior art publication shall be identified by its title, date of publication, and where feasible, author and publisher. Prior art under 35 U.S.C. § 102(b) shall be identified by specifying the item offered for sale or publicly used or known, the date the offer or use took place or the information became known, and the identity of the person or entity which made the use or which made and received the offer, or the person or entity which made the information known or to whom it was made known. Prior art under 35 U.S.C. § 102(f) shall be identified by providing the name of the person(s) from whom and the circumstances under which the invention or any part of it was derived. Prior art under 35 U.S.C. § 102(g) shall be identified by providing the identities of the person(s) or entities involved in and the circumstances surrounding the making of the invention before the patent applicant(s);

ii. Whether the prior art anticipates the claim or renders it obvious. If a combination of prior art references makes a claim obvious, that combination must be identified;

iii. Where, specifically, within each item of prior art each element of the claim is found; and

iv. All grounds of invalidity other than anticipation or obviousness. This identification must be as specific as possible. For example, each party asserting an enablement defense must set forth with particularity what is lacking in the specification to enable one skilled in the art to make or use the invention, specifically citing information or materials obtained in discovery to the extent feasible. Each party asserting an enablement defense must set forth with particularity what is lacking in the specification to enable one skilled in the art to make or use the invention.

b. Sixty (60) days from the date of the Scheduling Order, the Defendant shall serve the Plaintiff with a Proposed Claim Construction Statement containing the following information for each claim in issue:

i. Identification of any special or uncommon meanings of words or phrases in the claim;

ii. All references from the specification that support, describe, or explain each element of the claim;

iii. All material in the prosecution history that describes or explains each element of the claim; and

iv. Any extrinsic evidence that supports the proposed construction of the claim, including, but not limited to, expert testimony, inventor testimony, dictionary definitions and citations to learned treatises, as permitted by law.

c. Ninety (90) days from the date of the Scheduling Order, the Plaintiff shall serve upon the Defendant a Responsive Proposed Claim Construction Statement containing the following:

i. Identification of any special or uncommon meanings of words or phrases in the claim in addition to those disclosed in the Proposed Claim Construction Statement;

ii. All references from the specification that support, describe, or explain each element of the claim in addition to or contrary to those described in the Proposed Claim Construction Statement;

iii. All material in the prosecution history that describes or explains each element of the claim in addition to or contrary to those described in the Proposed Claim Construction Statement; and

iv. Any extrinsic evidence that supports the proposed construction of the claim, including, but not limited to, expert testimony, inventor testimony, dictionary definitions and citations to learned treatises, as permitted by law.

d. Amendment of a Claims Chart or a Responsive Claims Chart may be made only on stipulation of all parties or by Order of the Court, which shall be entered only upon a showing of excusable subsequent discovery of new information or extraordinary good cause.

e. One hundred twenty (120) days from the date of the Scheduling Order, the parties, having met and conferred on claim construction, the parties shall file a Joint Claim Construction Statement which shall contain the following information:

i. The construction of those claims and terms on which the parties agree;

ii. Each party's proposed construction of each disputed claim and term, supported by the same information that is required in the respective claim construction statements; and

iii. For any party who proposes to call one or more witnesses at any claim construction hearing, the identity of each such witness, the subject matter of his or her testimony, and an estimate of the time required for the testimony.

f. One hundred twenty (120) days from the date of the Scheduling Order, the parties shall file and serve opening briefs with supporting evidence and identification of any proposed Claim Construction Hearing witnesses.

g. One hundred fifty (150) days from the date of the Scheduling Order, the parties shall file and serve any responsive brief and supporting evidence directly rebutting their opponents supporting evidence and identifying any additional proposed Claim Construction Hearing witnesses.

Eastern District of Missouri Local Patent Rule 3-1(a)(viii)

(viii) In patent cases arising under 21 U.S.C. § 355, at or before the initial Rule 16 Scheduling Conference, the Alleged Infringer shall produce to the Patent Claimant the entire Abbreviated New Drug Application or New Drug Application that is the basis of the case. The Court recognizes that, in cases brought under 21 U.S.C. § 355, scheduling and sequencing provisions distinct from those set forth in these Local Patent Rules may be appropriate.

Western District of Tennessee Local Patent Rule 3.10

3.10 Disclosure Requirements for Patent Cases Arising Under 21 U.S.C. § 355 (commonly referred to as “the Hatch-Waxman Act”).

The following provisions apply to all patents subject to a Paragraph IV certification in cases arising under 21 U.S.C. § 355 (commonly referred to as “the Hatch-Waxman Act”). These provisions take precedence over any conflicting provisions in LPR 3.1–3.8 for all cases arising under 21 U.S.C. § 355.

(a) Production of New Drug Application. At or before the Patent Scheduling Conference, Defendant(s) shall produce to Plaintiff(s) the entire Abbreviated New Drug Application or New Drug Application that is the basis of the case in question.

(b) Invalidity Contentions. Within 14 days after the Patent Scheduling Conference, Defendant(s) shall provide to Plaintiff(s) written Invalidity Contentions for any patents referred to in Defendant(s) Paragraph IV Certification. At a minimum, these Invalidity Contentions should include those items required by LPR 3.5(a)-(d).

(c) Production of Materials Supporting Invalidity Contentions. Any Invalidity Contentions disclosed under LPR 3.10(b) shall be accompanied by the production of any document or thing that each Defendant intends to rely on to show invalidity. At a minimum, this disclosure should comply with LPR 3.6(a).

(d) Non-Infringement Contentions. Within 30 days after the Patent Scheduling Conference, Defendant(s) shall provide to Plaintiff(s) the written basis for their Non-Infringement Contentions for any patents referred to in Defendant(s) Paragraph IV Certification, which shall include a claim chart as required by LPR 3.3(a) identifying each claim at issue in the case and each limitation of each claim at issue. The claim chart shall specifically identify for each claim which claim limitation(s) are literally absent from the Defendant(s) allegedly infringing Abbreviated New Drug Application or New Drug Application.

(e) Production of Materials Supporting Non-Infringement Contentions. Any Non-infringement Contentions disclosed under LPR 3.10(d) shall be accompanied by the production of any document or thing that each Defendant intends to rely on in defense against any infringement contentions by Plaintiff(s), including those items required by LPR 3.4(a).

(f) Infringement Contentions. Within 45 days after the disclosure of the Non-Infringement Contentions as required by LPR 3.10(d), Plaintiff(s) shall provide Defendant(s) with Infringement Contentions for all patents referred to in Defendant(s) Paragraph IV Certification, including, at a minimum, those items required by LPR 3.1.

(g) Production of Materials Supporting Infringement Contentions. Any Infringement Contentions disclosed under LPR 3.10(f) shall be accompanied by the production of documents required under LPR 3.2.

Chapter 11

Design Patents

- 11.1 Substantive Law 2
 - 11.1.1 Statutory Basis 2
 - 11.1.2 Requirements for Patentability 2
 - 11.1.2.1 Definition of a Design 2
 - 11.1.2.2 Definition of an Article of Manufacture 2
 - 11.1.2.3 Ornamentality 3
 - 11.1.2.4 Inventorship 3
 - 11.1.2.5 Double Patenting 4
 - 11.1.3 Specification and Claim 4
 - 11.1.3.1 The Design Patent Claim 5
 - 11.1.3.2 Intersection of Design Patents and Related IP Laws 6
- 11.2 Case Management 7
 - 11.2.1 Infringement 7
 - 11.2.1.1 Ordinary Observer Test 9
 - 11.2.1.2 Claim Construction 9
 - 11.2.1.3 Product Scope 10
 - 11.2.2 Invalidity 10
 - 11.2.2.1 Functionality 10
 - 11.2.2.2 Anticipation 11
 - 11.2.2.3 Obviousness 11
 - 11.2.3 Patent Local Rules 13
 - 11.2.4 Remedies 13
 - 11.2.4.1 Injunctive Relief 13
 - 11.2.4.2 Damages 14

In 1842, Congress extended patent protection to “new and original designs for articles of manufacture” in a bill that borrowed heavily from the British Copyright of Designs Act.¹ The defined subject matter was

any new and original design for a manufacture, whether of metal or other material or materials, or any new and original design for the printing of woolen, silk, cotton, or other fabrics, or any new and original design for a bust, statue, or bas relief or composition in alto or basso relievo, or any new original impression or ornament to be placed on any article of manufacture, the same being formed in marble or other material, or any new and useful pattern, or print, or picture, to be either worked into or worked on, or printed or painted or cast or otherwise fixed on any article of manufacture or any new and original shape or configuration of any article of manufacture.

Act of Aug. 29, 1842, ch. 263, § 3, 5 Stat. 543, 543–44 (1842). Congress amended the design patent statute in 1902 to define the subject matter as simply “any new, original, and ornamental design for an article of manufacture.” Design patent protection was carried forward in the 1952 Patent Act without any substantive change. *See Falcon Indus., Inc. v. R. S. Herbert Co.*, 128 F. Supp. 204, 210 (E.D.N.Y. 1955).

1. See Jason J. Du Mont & Mark D. Janis, *The Origins of American Design Patent Protection*, 88 Ind. L.J. 837 (2013), for a fuller explication of the Act’s origins and the blending of patent language and examination procedures with copyright concepts.

11.1 Substantive Law

11.1.1 Statutory Basis

Design patent protection is available for “any new, original and ornamental design for an article of manufacture.” 35 U.S.C. § 171. Whereas the subject matter of a utility patent is how the article works or is used, the subject matter of a design patent is how the article looks—the overall *ornamental* appearance of an article. *L.A. Gear, Inc. v. Thom McAn Shoe Co.*, 988 F.2d 1117, 1123 (Fed. Cir. 1993). Like utility patents, design patents provide the exclusive rights to the ornamental features. § 171 (“The provisions of this title relating to patents for inventions shall apply to patents for designs, except as otherwise provided.”). Under § 173, the term of design patents is fourteen years from the date of issuance for applications filed before May 13, 2015, and fifteen years for applications filed on or after May 13, 2015.

The United States joined the Hague Union, effective May 13, 2015. *See* Patent Law Treaties Implementation Act of 2012, Pub. L. 112-211, 126 Stat. 1527 (2012). The Hague Agreement permits applicants to file a single international design application with either the World Intellectual Property Office (WIPO) or the USPTO to obtain design protection in member states. To implement the Hague Agreement, the term of design patents has been extended to fifteen years from issuance.

Certain design patents have been granted perpetual or renewable rights. Congress renews protection for the seal of the American Legion (U.S. Patent No. D54,296) every fourteen years, while the Red Cross symbol (U.S. Patent No. D54,308) was made perpetual by 18 U.S.C. § 706 (2012).

11.1.2 Requirements for Patentability

11.1.2.1 Definition of a Design

A patentable design consists of the configuration, surface ornamentation, or both, embodied in or applied to an article of manufacture. A design must be definite and reproducible. Designs that change in appearance during an article’s use—such as animated designs for graphical user interfaces—may be protected, typically by the use of illustrations that show the different stages of the design’s appearance. A design may be embodied in or applied to an entire article of manufacture, or only a portion thereof. *See In re Zahn*, 617 F.2d 261, 267–69 (C.C.P.A. 1980).

11.1.2.2 Definition of an Article of Manufacture

A design must be embodied in or applied to an article of manufacture. “Article of manufacture” has been interpreted broadly to encompass tools, machines, and any “manufacture” within the meaning of § 101. *See In re Koehring*, 37 F.2d 421, 424 (C.C.P.A. 1930) (holding that a compact and symmetrical design for a concrete truck possessed “more grace and pleasing appearance than existed in the prior art” and thus should be accorded a design patent). A manufacture is “anything made ‘by the hands of man’ from raw materials, whether literally by hand or by machinery or by

art.” *In re Hruby*, 373 F.2d 997 (C.C.P.A. 1967) (upholding a design created by the flow of water in a fountain as patentable). A design may be for only part of an article. See *In re Zahn*, 617 F.2d at 267–69. After some initial resistance, the PTO adopted guidelines that recognize that “computer-generated icons” may constitute articles of manufacture. See Guidelines for Examination of Design Patent Applications for Computer-Generated Icons, 61 FR 11380 (1996); see William J. Seymour & Andrew W. Torrance, *(R)evolution in Design Patentable Subject Matter: The Shifting Meaning of “Article of Manufacture,”* 17 Stan. Tech. L. Rev. 183, 200–05 (2014).

11.1.2.3 Ornamentality

Although § 171 requires that designs be ornamental to be patentable, most courts have assessed ornamentality by asking whether the design is dictated by functional considerations. See, e.g., *Best Lock Corp. v. Ilco Unican Corp.*, 94 F.3d 1563 (Fed. Cir. 1996); *In re Carletti*, 328 F.2d 1020, 1022 (C.C.P.A. 1964); see also Jason J. Du Mont & Mark D. Janis, *Functionality in Design Protection Systems*, 19 J. Intell. Prop. L. 261 (2012) (analyzing the ornamentality cases). A design must be the product of “aesthetic skill and artistic conception.” *Blisscraft of Hollywood v. United Plastics Co.*, 294 F.2d 694, 696 (2d Cir. 1961); see also *In re Koehring*, 37 F.2d 421 (C.C.P.A. 1930) (upholding the design for a concrete mixer as patentable because the design created a “more symmetrical and compact whole”).

Patentability may be barred where designs are hidden or obscured while in use or where their appearance cannot be a matter of concern. Compare *Ex parte Jaffe*, 147 U.S.P.Q. 45 (PTO Bd. App. 1964) (denying a patent application for a functional circuit board covered during use) with *In re Webb*, 916 F.2d 1553 (Fed. Cir. 1990) (upholding patentability of the design for a femoral hip stem prosthesis because its appearance could be a matter of concern at the point of sale, even though it would ultimately be concealed). The patented design must be considered as a whole, encompassing all ornamental features *visible* at any time during normal use. *Contessa Food Prods., Inc. v. Conagra, Inc.*, 282 F.3d 1370, 1379 (Fed. Cir. 2002) (abrogated on other grounds). “Normal use” is not limited to only one phase or portion of the lifetime of a product. See *Int’l Seaway Trading Corp. v. Walgreens Corp.*, 589 F.3d 1233 (Fed. Cir. 2009). “‘Normal use’ in the design patent context extend[s] over ‘a period in an article’s life beginning after completion of manufacture or assembly and ending with the ultimate destruction, loss or disappearance of the article.’” *Contessa Food Prods.*, 282 F.3d at 1379 (quoting *In re Webb*, 916 F.2d 1553, 1557–58 (Fed. Cir. 1990)).

The USPTO’s policy is to reject applications for designs that could be deemed offensive to any race, religion, sex, ethnic group, or nationality.

11.1.2.4 Inventorship

A design patent may be obtained by “whoever invents any new, original and ornamental design for an article of manufacture.” *Hoop v. Hoop*, 279 F.3d 1004 (Fed. Cir. 2002). Merely suggesting a design concept is not sufficient. The standard of inventorship is the same for both utility and design patents. An inventor is the person

who conceives the invention. A person who assists an inventor after the conception of the invention cannot gain inventorship. Similarly, after conception, an inventor may use the services, ideas, and aid of others in the process of perfecting his or her invention without losing inventorship. In the case of interference, the ultimate test for design-patent inventorship is whether the second asserted invention is “substantially similar” to the first. *See id.*

11.1.2.5 Double Patenting

As with utility patents, the double-patenting doctrine precludes a person from obtaining more than one design patent for the same invention or obvious modifications to his or her invention. For multiple design patents issued to the same inventor, “same invention”-type double patenting occurs if “identical designs with identical scope” are twice claimed. If the designs are not identical, the obviousness-type double-patenting inquiry is whether the two designs are patentably distinct. In the case of non-identical designs, an applicant may overcome an obviousness-type double-patenting rejection by filing a terminal disclaimer, whereby the applicant agrees that the later-filed application will expire at the same time as the prior patent (or application). *See* § 14.2.5.1. A same-invention-type double-patenting rejection is statutory and may not be overcome with a terminal disclaimer.

The doctrine of double patenting may also preclude separate design and utility patents on related subject matter. In the case of same invention-type double patenting and some instances of obviousness-type double patenting (those in which the application at issue is the earlier filed of the two), a two-way unpatentability standard is used to determine double patenting: the claimed subject matter of each patent must be identical or obvious in light of the subject matter of the other. *See In re Dembiczak*, 175 F.3d 994 (Fed. Cir. 1999); *Carman Indus., Inc. v. Wahl*, 724 F.2d 932 (Fed. Cir. 1983). Double patenting can be found in the case of a design patent application over an earlier-issued utility patent (*see, e.g., In re Barber*, 81 F.2d 231, 28 U.S.P.Q. 187 (C.C.P.A. 1936)) or a utility patent application over an earlier-issued design patent (*see, e.g., In re Thorington*, 418 F.2d 528 (C.C.P.A. 1969)).

11.1.3 Specification and Claim

Like utility patents and unlike copyrights, design patents are examined and not merely registered. *See* USPTO, Manual of Patent Examining Procedure, part 1500 *et seq.* The § 112 requirements of adequate disclosure and definite claiming also apply to design patents. *See In re Owens*, 710 F.3d 1362 (Fed. Cir. 2013). In the case of design patents, both disclosure and definiteness are accomplished through the drawings. Only one claim is permitted in design patent applications. This claim takes the form of “the ornamental design of the specified article as shown.” Although only one claim is permitted, a design application may illustrate multiple embodiments of a design if they involve a single inventive concept. *See In re Rubenfield*, 270 F.2d 391 (C.C.P.A. 1959).

The USPTO requires an applicant to “designate the particular article” for which a design patent is sought, although the patent need not depict the article and can represent it generically (as in the case of surface ornamentation). The degree of spec-

ificity with which an applicant must describe and claim the article is not straightforward. See *Ex parte Fulda*, 1913 Comm'n Dec. 206 (Comm'r Dec. Pat. 1913); *Ex parte Cadey*, 1916 Comm'n Dec. 57 (Comm'r Dec. Pat. 1916); *Ex parte Andrews*, 1917 Comm'n Dec. 13 (Comm'r Dec. Pat. 1916); *Ex parte Ginzburg*, 1925 Comm'n Dec. 159 (Comm'r Dec. Pat. 1925). For designs of “an ornament, impression, print or picture to be applied to an article of manufacture,” an applicant may make a broad claim to the use of the ornament on more than one article. See *In re Schnell*, 46 F.2d 203 (C.C.P.A. 1931). In this case, the applicant must teach the manner of applying the design to show reduction to practice. *Id.* For designs that consist of a shape or configuration for an article of manufacture, the claim and specification must be narrower. *Id.*

Drawings must contain a “sufficient number of views to constitute a complete disclosure of the appearance of the design.” 37 C.F.R. § 1.152(a) (2014). If the drawings are insufficient, a patent may be declared invalid under § 112.

11.1.3.1 The Design Patent Claim

The solid lines of a drawing define the scope of the claimed invention. The dotted or dashed lines merely provide context; they do not limit the scope of the claimed design. The illustration below reflects a typical design patent:

Figure 1
U.S. Patent No. D517,789 S

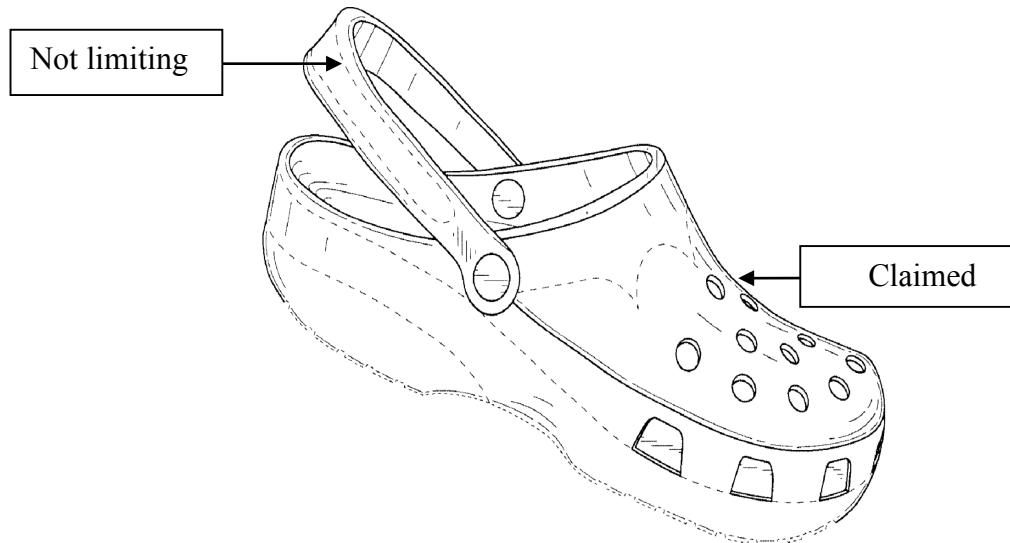

11.1.3.2 Intersection of Design Patents and Related IP Laws

Design patent protection and trade dress protection are conceptually similar in that both are ways of protecting the visual impression that products (or, sometimes, services) convey. Design patents and trade dress, however, serve different functions: a design patent encourages design innovation by rewarding inventors with a time-limited right to exclude infringers. Trade dress law instead protects consumers' expectation that a product with a particular configuration comes from a particular source. Thus, while design patent infringement requires only a showing that the accused product appears to embody the patented design as depicted in the patent's drawings, trade dress infringement further requires proof of secondary meaning (that is, that the design has come to identify its source of manufacture or supply) and a likelihood of consumer confusion.

At present, there is no requirement that a designer elect between design patent protection and trade dress protection for the same design. Several decades ago, the C.C.P.A. held that the existence of a design patent does not preclude an applicant from registering a product shape on the Principal Register (see *In re Mogen David Wine Corp.*, 328 F.2d 925, 929 (C.C.P.A. 1964), *aff'd*, 372 F.2d 539, 152 U.S.P.Q. 593 (C.C.P.A. 1967); *In re Morton-Norwich Prods., Inc.*, 671 F.2d 1322 (C.C.P.A. 1982)), and this remains the USPTO's practice. On the other hand, the Supreme Court has made clear that the obstacles to protecting product design through trade dress are substantial. See *Wal-Mart Stores, Inc. v. Samara Bros., Inc.*, 529 U.S. 205 (2000) (product design trade dress is distinctive only upon a showing of secondary meaning); *Traffix Devices, Inc. v. Mktg. Displays, Inc.*, 532 U.S. 23 (2001) (product design trade dress is nonfunctional only if it is not essential to the use or purpose of the product, and that it does not affect the cost or quality of the product). Accordingly, many designs that are protectable under design patent law might fail to satisfy the tests for protectable trade dress. See, e.g., *Apple Inc. v. Samsung Elecs. Co.*, 786 F.3d 983 (Fed. Cir. 2015) (upholding design patents against a functionality challenge but striking down trade dress on functionality grounds).

Design patents and copyrights protect similar types of works. The critical distinction here is that a copyright only extends to the actual sculptural work and derivations of it. Moreover, copyright infringement requires proof of *copying*, not merely of similarity of protectable features viewed as a whole. However, a design patent does not preclude protection for the same design under trademark and copyright law. See *Rosenthal v. Stein*, 205 F.2d 633, 635 (9th Cir. 1953) ("The area in which a thing would be either a copyrightable work of art or a patentable design, but not the other, is perhaps unsurveyable. Whether a thing is a work of art or a patentable design, or is a patentable design and not a work of art, cannot be determined by excluding one from the other. A thing is a work of art if it appears to be within the historical and ordinary conception of the term art. A thing is a design by the same token. The two are not necessarily distinct one from the other. Neither goes to the functioning of a utility."). Thus, the Statue of Liberty was formerly protected by U.S. Design Patent No. D11,023 as well as Copyright Registration No. 9939-G.

11.2 Case Management

11.2.1 Infringement

Design patent infringement is a question of fact, which must be proven by a preponderance of the evidence. See *L.A. Gear, Inc.*, 988 F.2d at 1124. Infringement of a design patent is determined by applying the “ordinary observer” test:

[I]f, in the eye of an ordinary observer, giving such attention as a purchaser usually gives, two designs are substantially the same, if the resemblance is such as to deceive such an observer, inducing him to purchase one supposing it to be the other, the first one patented is infringed by the other.

Gorham Co. v. White, 81 U.S. 511, 528 (1871); *Egyptian Goddess, Inc. v. Swisa, Inc.*, 543 F.3d 665, 670 (Fed. Cir. 2008) (en banc). The ordinary observer is “deemed to view the differences between the patented design and the accused product in the context of the prior art.” *Egyptian Goddess*, 543 F.3d at 676–77.

When the differences between the claimed and accused design are viewed in light of the prior art, the attention of the hypothetical ordinary observer will be drawn to those aspects of the claimed design that differ from the prior art. And when the claimed design is close to the prior art designs, small differences between the accused design and the claimed design are likely to be important to the eye of the hypothetical ordinary observer.

Id. at 676.

Under *Egyptian Goddess*, where the accused design is not plainly dissimilar to the patented design, reference to the prior art can provide a useful tool to analyze infringement. See *id.* at 678. Particular care should be given in crowded fields with many prior-art designs. Even subtle differences may become significant. *Id.* There may also be instances where the accused design is sufficiently distinct from the patented design such that no comparison to the prior art is necessary. *Id.* It is typically useful for a court to review the nearest prior art, just as with utility patents. *Lytton Sys. Inc. v. Whirlpool*, 728 F.2d 1423, 1444 (Fed. Cir. 1984). By contrast, the analysis for design patents is purely visual, so the court should expect to compare exemplars of both the accused product and any relevant prior-art products. See *Richardson v. Stanley Works*, 597 F.3d 1288, 1296 (Fed. Cir. 2010) (emphasizing “the decisive importance of drawings in a design patent”). The design-patented product is less important because the infringement analysis compares the design patent *claims/drawings* and the accused product—not the patented *product* and the accused one. The court, therefore, should carefully consider how to ensure that the trier of fact has access to these embodiments and the appropriate comparisons.

It is customary in design patent cases to use a “visual claim chart,” showing the patented images next to the accused products, using the same angles depicted in the design patent. For example:

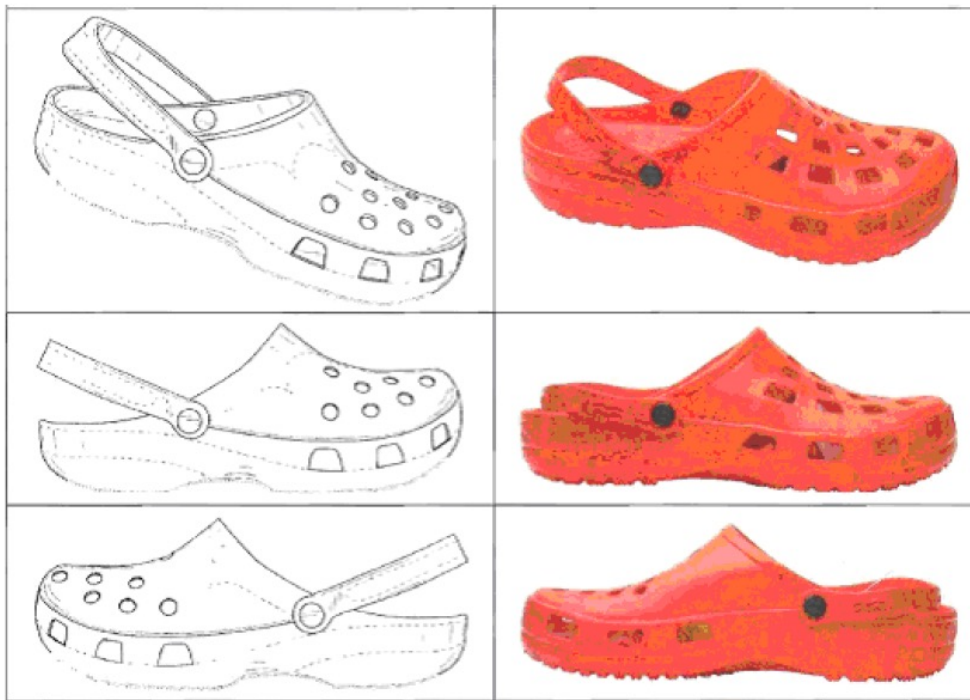

A visual claim chart will typically contain a comparison from each angle depicted in the design patent. See *Crocs, Inc. v. Int’l Trade Comm’n*, 598 F.3d 1294 (Fed. Cir. 2010); see also *Richardson*, 597 F.3d at 1296 (“design patents are typically claimed according to their drawings, and claim construction must be adapted to a pictorial setting”).

A court should compare the overall effect of the patented and accused designs. *Crocs, Inc.*, 598 F.3d at 1303. “In other words, ‘the deception that arises is a result of the similarities in the overall design, not of similarities in ornamental features in isolation.’” *Id.* (quoting *Amini Innovation Corp. v. Anthony Cal., Inc.*, 439 F.3d 1365, 1371 (Fed. Cir. 2006)). When a design contains functional elements alongside ornamental aspects, a court should exclude those functional elements provided the infringement test still evaluates the similarities in overall design between the accused product and claimed design, rather than comparing the two on an element-by-element basis. See *Richardson*, 597 F.3d at 1296.

Because the infringement test hinges on the reactions of an ordinary observer, courts have approved—but do not in all cases require—the use of customer surveys or other evidence of consumer motivation to establish infringement or injury. *Apple, Inc. v. Samsung Elecs. Co.*, 678 F.3d 1314, 1338–39 (Fed. Cir. 2012).

The principles of equivalency apply to design patents, according to the Federal Circuit, but not as a separate doctrine of equivalents. Rather, the notion of equivalency is subsumed within the *Gorham* substantial similarity standard and within the

statutory language extending infringement liability to “colorable imitations” of the patented design. *Lee v. Dayton-Hudson Corp.*, 838 F.2d 1186, 1189 (Fed. Cir. 1988); § 289. Having decided that equivalency principles applied to design patents, the Federal Circuit has also decided that a version of the doctrine of prosecution history estoppel should likewise apply to design patents. *See Pac. Coast Marine Windshields Ltd. v. Malibu Boats, LLC*, 739 F.3d 694, 701 (Fed. Cir. 2014).

11.2.1.1 Ordinary Observer Test

Similarity between a patented design and an accused design is determined from the perspective of the “ordinary observer.” The pertinent “observers” are the ordinary purchasers of the accused article. *Goodyear Tire & Rubber Co. v. Hercules Tire & Rubber Co., Inc.*, 162 F.3d 1113 (Fed. Cir. 1998).

The ordinary observer test is subject to several refinements and qualifications. Similarities must relate to the claimed design, not the plaintiff’s particular embodiment. *See OddzOn Prods., Inc. v. Just Toys, Inc.*, 122 F.3d 1396 (Fed. Cir. 1997). Furthermore, similarity must arise from the nonfunctional aspects of a design. *See id.* at 1404–06. With respect to the determination of similarity, older authorities make clear that similarity between the patented and accused designs is not necessarily to be determined in a side-by-side comparison. *See, e.g., Ashley v. Weeks-Numan Co.*, 220 F. 899 (2d Cir. 1915). More recently, the Federal Circuit has seemed to signal a preference for a side-by-side comparison. *See, e.g., Arminak & Assoc., Inc. v. Saint-Gobain Calmar, Inc.*, 501 F.3d 1314, 1327 (Fed. Cir. 2007)

The Federal Circuit’s en banc decision in *Egyptian Goddess* held that the *Gorham* ordinary observer test is the sole test for determining infringement of a design patent, specifically overturning the former “point of novelty” test. The Federal Circuit has held that *OddzOn*, which excluded functional elements of a design in an infringement analysis, is not undermined by *Egyptian Goddess*. *See Richardson*, 597 F.3d at 1293.

11.2.1.2 Claim Construction

Because design patents “typically are claimed as shown in drawings,” trial courts are no longer required “to provide a detailed verbal description of the claimed design, as is typically done in the case of utility patents.” *Egyptian Goddess*, 543 F.3d at 679 (citations omitted). *Egyptian Goddess* was an important change from prior law, in which the court was expected to describe the design-patented features in writing. *Egyptian Goddess* and its progeny make clear that a detailed verbal description of the asserted patent is unnecessary and that it is appropriate to “rely upon the illustrations set out in the [the patent], as they better represent the claimed design.” *Arc’teryx Equip., Inc. v. Westcomb Outerwear, Inc.*, 2008 U.S. Dist. LEXIS 90228, 2008 WL 4838141 (D. Utah Nov. 4, 2008); *see also Dexas Int’l, Ltd. v. Office Max, Inc.*, 2009 WL 252164, 2009 U.S. Dist. LEXIS 6642, at *19–20 (E.D. Tex. Jan. 30, 2009) (same). The preferred approach is to limit the detail in any verbal description of a design patent. *Egyptian Goddess*, 543 F.3d at 679; *Crocs*, 598 F.3d at 1302 (“This court has cautioned, and continues to caution, trial courts about excessive reliance on a detailed verbal description in a design infringement case.”). Nevertheless, the

level of detail a court uses to describe a claimed design is a matter of discretion, and “absent a showing of prejudice, [a] court’s decision to issue a relatively detailed claim construction will not be reversible error.” *Egyptian Goddess*, 543 F.3d at 679.

A court may also, to the extent it would be helpful either to a jury or in the court’s own analysis, describe the features of the claimed design as they relate to the accused product and prior art or to explain various conventions in design patent drafting, such as the use of solid and broken lines, aspects of the prosecution history, or any functional features. *Id.* at 680.

11.2.1.3 Product Scope

Section 289 provides that infringement occurs when the patented design is applied to “any article of manufacture.” Design patent infringement may be found even when the accused infringer’s products are not directly competitive with the patentee’s. *See Avia Grp. Int’l, Inc. v. L.A. Gear Cal., Inc.*, 853 F.2d 1557, 1565 (Fed. Cir. 1988) (“To find infringement, the accused articles need only appropriate a patentee’s protected design, not a patentee’s market as well.”). “[I]ndeed, an infringer is liable even when the patent owner puts out no product.” *Id.*

11.2.2 Invalidity

Like utility patents, design patents are also subject to validity challenges, which must be proven by clear and convincing evidence. The same general invalidity arguments can apply, including written description, enablement, and indefiniteness challenges under § 112, as well as anticipation under § 102 and obviousness challenges under § 103. A design patent can also be deemed invalid for lacking ornamentality or for claiming a design that is purely functional. The most common challenges are functionality, anticipation, and obviousness.

11.2.2.1 Functionality

Design patents protect only ornamental or “nonfunctional” designs. The design of an article is deemed to be “functional” when the appearance is dictated by the use or purpose of the article. *See L.A. Gear*, 988 F.2d at 1123; *In re Carletti*, 328 F.2d 1020, 1022 (C.C.P.A. 1964) (when a configuration is the result of functional considerations only, the resulting design is not patentable as an ornamental design—even where the result is “pleasing to look upon”). A patent for a design that is primarily functional rather than ornamental is invalid. *See Richardson*, 597 F.3d at 1293–94.

While a design may be part of an object or device that has a function (e.g., a hammer with specific design), the design aspect itself must be nonfunctional. The determination of whether the patented design is dictated by the function of the article ultimately rests on an analysis of its overall appearance. *See PHG Techs., LLC v. St. John Cos.*, 469 F.3d 1361, 1366 (Fed. Cir. 2006). In determining whether a design feature is purely functional, courts consider factors such as: (1) whether there are alternate ways to design the article to achieve the same function, *see Seiko Epson Corp. v. Nu-Kote Int’l, Inc.*, 190 F.3d 1360, 1368 (Fed. Cir. 1999) and *Rosco, Inc. v.*

Mirror Lite Co., 304 F.3d 1373, 1378 (Fed. Cir. 2002); (2) the existence of any concomitant utility patents, see *Traffix Devices, Inc. v. Mktg. Displays, Inc.*, 532 U.S. 23, 29 (2001) (“A utility patent is strong evidence that the features therein claimed are functional.”); (3) whether the design is aesthetically pleasing and not dictated by function alone, see *Bonito Boats, Inc. v. Thunder Craft Boats, Inc.*, 489 U.S. 141, 148 (1989); (4) whether alternative designs would adversely affect the utility of the article, see *PHG Techs.*, 469 F.3d at 1366; and (5) whether there are any elements in the design or an overall appearance clearly not dictated by function, see *id.*

11.2.2.2 Anticipation

In considering whether a design patent is anticipated by the prior art under § 102, the “ordinary observer” test is applied. See *Int’l Seaway Trading Corp. v. Walgreens Corp.*, 589 F.3d 1233, 1240 (Fed. Cir. 2009) (holding that the same tests must be applied to infringement and anticipation). As with infringement, the test applies only to those aspects of the design that are visible at some point during the “normal use lifetime” of the product and prior art, which includes from the point of sale through any use by consumers. *Id.* at 1241.

Anticipation requires a showing that a single prior-art reference is “identical in all material respects” to the claimed invention. *OddzOn Prods., Inc. v. Just Toys, Inc.*, 122 F.3d 1396, 1404 (Fed. Cir. 1997). First, the claim must be construed. Then the construed claim is compared to the design disclosed in the allegedly anticipatory prior-art reference, assuming that reference has qualified as prior art under the applicable provisions of § 102. If the claimed design and the alleged prior-art design are substantially the same, the alleged prior-art design anticipates the claimed design. Designs are “substantially the same” when their resemblance is deceptive to the extent that it would induce the ordinary observer to purchase an article, supposing it to be the other. *Door-Master Corp. v. Yorktowne, Inc.*, 256 F.3d 1308, 1313 (Fed. Cir. 2001). Once identity is established, a prior design will anticipate even if it is an article having a different use or is in a nonanalogous art. See *In re Glavas*, 230 F.2d 447, 450 (C.C.P.A. 1956).

The experimental use exception to the § 102(b) “public use” and “on sale” bars has limited application to design patents. See §§ 14.3.4.1.1, 14.3.4.1.5.1, 14.3.4.1.5.2. An ornamental design alone for an article of manufacture cannot qualify under the experimental use exception. *In re Mann*, 861 F.2d 1581 (Fed. Cir. 1988) (“obtaining the reactions of people to a design, whether they like it or not, is not experimentation”). However, where experimentation is directed to the functional features of an article, the use may fall within the experimental use exception. See *Tone Bros., Inc. v. Sysco Corp.*, 28 F.3d 1192 (Fed. Cir. 1994); § 14.3.4.1.5.1.

11.2.2.3 Obviousness

Like utility patents, design patents must also meet the nonobviousness requirement of § 103. See *Titan Tire Corp. v. Case New Holland, Inc.*, 566 F.3d 1372, 1380 (Fed. Cir. 2009). Challenges to a design patent under § 103 may include evidence from one skilled in the art regarding prior-art references and whether and how those references would be combined to form a design that compares to the claimed design.

The test for obviousness is different from the test for infringement and anticipation. Whereas the comparison of the claimed design to an accused article or potentially anticipatory prior art is seen through the eyes of the “ordinary observer,” the comparison of the claimed design to the prior art for obviousness purposes is seen through the eyes of the “ordinary designer.” *High Point Design LLC v. Buyers Direct, Inc.*, 730 F.3d 1301, 1311 (Fed. Cir. 2013); *Apple*, 678 F.3d at 1324 (“In addressing a claim of obviousness in a design patent, the ultimate inquiry is whether the claimed design would have been obvious to a designer of ordinary skill who designs articles of the type involved.”). In *High Point Design*, the Federal Circuit held that it was error to apply the “ordinary observer” standard to assess obviousness, and suggested that *International Seaway* was not to the contrary. 730 F.3d at 1312 & n.2.

Federal Circuit decisions set forth a two-step process for the obviousness inquiry, which includes a “primary reference” requirement. In the first step, one must find a single prior-art reference that has design characteristics “basically the same as the claimed design” (the “primary reference”). In the second step, “other references may be used to modify it to create a design that has the same overall visual appearance as the claimed design.” *High Point*, 730 F.3d at 1311 (quoting *Durling v. Spectrum Furniture Co.*, 101 F.3d 100, 103 (Fed. Cir. 1996)) (internal quotations omitted); *MRC Innovations, Inc. v. Hunter Mfg., LLP*, 747 F.3d 1326, 1331–32 (Fed. Cir. 2014).

The pertinent references sought to be combined to show obviousness need not be analogous arts in the mechanical sense, but must be so related that the “appearance of certain ornamental features in one would suggest the application of those features to another.” *In re Glavas*, 230 F.2d 447 (C.C.P.A. 1956). It remains unsettled to what extent the Supreme Court’s ruling in *KSR International v. Teleflex, Inc.*, 550 U.S. 398 (2007), should be applied to design patents. See *Titan Tire*, 566 F.3d at 1384–85; see also Petition for Writ of Certiorari at i, 5–6, *MRC Innovations, Inc. v. Hunter Mfg., LLP*, 135 S. Ct. 182 (2014) (No. 14–5), 2014 U.S. LEXIS 6444, 2014 WL 2986575, at *I, *5–*6 (presenting question whether *KSR* requires court to articulate a basis for combining known elements to find design patent invalid). In applying the “so related” requirement, the Federal Circuit has continued to rely on its pre-*KSR* jurisprudence. See, e.g., *MRC Innovations*, 747 F.3d at 1334 (Fed. Cir. 2014) (quoting *In re Borden*, 90 F.3d 1570, 1574 (Fed. Cir. 1996) (“In order for secondary references to be considered, there must be some suggestion in the prior art to modify the basic design with features from the secondary references.”)).

Some decisions suggest that more weight should be given to secondary considerations, particularly commercial success, than in the case of utility patents. Design patent law specifically aims “to encourage ornamentation and beautification in manufactured articles so as to increase their salability and satisfy the aesthetic sense of the purchasers.” *Forestek Plating & Mfg. Co. v. Knapp-Monarch Co.*, 106 F.2d 554, 559 (6th Cir. 1939). However, it must be clear “that the commercial success is attributable to the design, and not to some other factor, such as a better-recognized brand name or improved function.” *Litton Sys., Inc. v. Whirlpool Corp.*, 728 F.2d 1423, 1443 (Fed. Cir. 1984).

11.2.3 Patent Local Rules

Most patent local rules (PLRs) are directed to utility patent cases. *See, e.g.*, N.D. Ga. Pat. L.R. 1.2(b) (limiting PLRs to utility patent cases); N.D. Ill. Pat. L.R. 1.1 (same); E.D. Tex. Pat. L.R. 1-2 (same), E.D. Mo. Pat. L.R. 1-2(b) (same). Several districts allow parties to extend their PLRs to non-utility patent disputes where appropriate. *See, e.g.*, N.D. Cal. Pat. L.R. 1-2; S.D. Cal. Pat. L.R. 1-3, 1-4. The District of New Jersey specifically excludes design patents from the more detailed pretrial patent proceedings, including claim construction, infringement contentions, and invalidity contentions. *See* D.N.J. Pat. L.R. 3.1(c) & (e), 3.3(c), 3.4A(c), 4.1(c), 4.2(e), 4.3(g), 4.4, & 4.5(d) (2011). The District of New Jersey Local Patent Rules Committee noted that, in light of the Federal Circuit decision in *Egyptian Goddess v. Swisa*, 543 F.3d 665 (2008), a trial court should not provide a detailed verbal description of the claimed design and that it was not appropriate to apply “certain of the Local Patent Rules which call for a narrative claims chart, claim construction contentions and a claim construction hearing” to design patent cases. *See* District of New Jersey, Report of the Local Patent Rules Committee, Explanatory Notes for 2011 Amendments, *available at* <http://www.njd.uscourts.gov/sites/njd/files/PatentRuleAmendment2011.pdf>.

The Northern District of New York also excludes design patents from the more detailed claim-construction procedures (N.D.N.Y. Pat. L.R. 4.1), but requires design patent holders to provide specific infringement contentions (N.D.N.Y. Pat. L.R. 3.1(c)(ii)) (“For each design patent or variety of plant patent claim that is alleged, a chart displaying each view of the design or variety of plant patent drawings and a view of the accused design or variety of plant from every available angle for all embodiments.”) and defendants must respond by explaining any denial of substantial similarity (N.D.N.Y. Pat. L.R. 3.3(a)) and by providing specific invalidity contentions. N.D.N.Y. Pat. L.R. 3.3(b)(1) (invalidity contentions must contain the “identity of each item of prior art that allegedly anticipates each asserted claim or renders it obvious, including in the case of a design or variety of plant patent a view from every available angle and all available embodiments”).

11.2.4 Remedies

All of the remedies available for utility patent infringement are available for design patent infringement. § 171 (2012) (“The provisions of this title relating to patents for inventions shall apply to patents for designs, except as otherwise provided.”). Design patentees can recover damages under § 284, obtain injunctive relief under § 283, reasonable attorney fees in exceptional cases under § 285, and so forth, so long as they comply with the same formalities (e.g., marking under § 287).

Section 289 provides a special additional damages remedy for design patent infringement, which is discussed below.

11.2.4.1 Injunctive Relief

A design patent plaintiff must satisfy the *eBay* test for preliminary or permanent injunctive relief, just as in a utility patent case. *See* §§ 3.2, 9.2.1. Because the analysis focuses

on the *ornamental design* depicted in the patent, the patentee must make a slightly different factual showing with respect to the first *eBay* factor, irreparable injury: the design patentee must show “some causal nexus between” the defendant’s *design* and the plaintiff’s alleged injury. *Apple*, 678 F.3d at 1324; *cf.* §§ 3.2.2.2.4, 9.2.1.1. It also is possible to demonstrate irreparable harm by showing “design dilution,” meaning that the presence of similar substitutes diminishes the value of the patented design. *Id.* at 1325 (noting, however, that the lower court properly had not found design dilution in the case at bar).

11.2.4.2 Damages

There is a special additional remedy available to design patentees:

Whoever during the term of a patent for a design, without license of the owner, (1) applies the patented design, or any colorable imitation thereof, to any article of manufacture for the purpose of sale, or (2) sells or exposes for sale any article of manufacture to which such design or colorable imitation has been applied shall be liable to the owner to the extent of his *total* profit, but not less than \$250, recoverable in any United States district court having jurisdiction of the parties.

Nothing in this section shall prevent, lessen, or impeach any other remedy which an owner of an infringing patent has under the provisions of this title, but he shall not twice recover the profit made from the infringement.

§ 289 (emphasis added). Thus, a design patent owner can obtain the infringer’s *total* profits for sale of an article to which the infringing design has been applied, but no less than \$250. § 289; *see Apple Inc. v. Samsung Elecs. Co., Ltd.*, 786 F.3d 983 (Fed. Cir. 2015) (rejecting contention that § 289 incorporates an apportionment requirement under basic causation principles); *see also Schnadig Corp. v. Gaines Mfg. Co.*, 620 F.2d 1166, 1171 (6th Cir. 1980); *Henry Hanger & Display Fixture Corp. of Am. v. Sel-O-Rak Corp.*, 270 F.2d 635, 643–44 (5th Cir. 1959); *Bergstrom v. Sears, Roebuck & Co.*, 496 F. Supp. 476, 495 (D. Minn. 1980).

To establish profits under § 289, the patentee need only demonstrate the defendant’s total sales. The defendant typically then demonstrates what portion of those sales is not attributable to the infringing design. Importantly, § 289(2) applies to any entity that “sells or exposes for sale any article of manufacture to which such design or colorable imitation has been applied.” This means that distributors and retailers can be liable for *their* total profit, which likely far exceeds the manufacturer’s total profit. Thus, design patent cases often give rise to indemnity disputes between manufacturers and retailers, because the possible total exposure for accused items with significant retail markups can easily surpass the manufacturer’s total revenue, to say nothing of its total profit.

While § 289 is an additional remedy available to design patent holders, a design patentee cannot “twice recover” an infringer’s profits. *See* § 289 (“Nothing in this section shall prevent, lessen, or impeach any other remedy which an owner of an infringed patent has under the provisions of this title, but he shall not twice recover the profit made from the infringement.”). For example, a patentee is not entitled to both a reasonable royalty *and* the infringer’s profits. *See Catalina Lighting, Inc. v. Lamps Plus, Inc.*, 295 F.3d 1277, 1291 (Fed. Cir. 2002). Similarly, when a utility patent and a design patent are asserted against the same accused product, a patentee can only recover damages for the single infringing act. *See id.* at 1292.

Chapter 12

Plant Patents

12.1	Substantive Law	2
12.1.1	Statutory Basis	2
12.1.1.1	Plant Patent Act	2
12.1.1.2	Plant Variety Protection Act	2
12.1.1.3	Utility Patents	3
12.1.2	The Plant Patent Claim	3
12.1.3	The PVP Certificate	3
12.1.4	Utility Patent Claims Related to Plants	4
12.2	Case Management	5
12.2.1	Plant Patents	5
12.2.1.1	Eligibility Requirements	5
12.2.1.2	Determination of Infringement of Plant Patents	5
12.2.1.2.1	Meaning of the Term “Variety”	6
12.2.1.2.2	Meaning of “Asexual Reproduction”	6
12.2.1.3	Invalidity of Plant Patents	7
12.2.1.3.1	Anticipation	7
12.2.1.3.2	Obviousness	8
12.2.1.4	Remedies Under the Plant Patent Act	8
12.2.2	Plant Variety Protection	8
12.2.2.1	Determination of Infringement Under the PVPA	8
12.2.2.1.1	Essentially Derived Varieties	9
12.2.2.1.2	PVPA Exemptions	9
12.2.2.2	Invalidity of PVP Certificates	10
12.2.2.3	Remedies Under the PVPA	10
12.2.3	Utility Patent Issues Related to Plants	11
12.2.3.1	Patent Exhaustion	11
12.2.3.2	Patent Misuse	11
12.2.3.3	Indirect Infringement	12
12.2.4	Other Plant-Related IP Issues: Variety Names and Trademarks	12

Prior to 1930, inventions in plants faced two obstacles to patentability. First, some commentators believed that plants might not qualify as eligible subject matter for patent protection because they are products of nature. *See, e.g., Ex parte Latimer*, 1889 Comm’n Dec. Pat. 123 (1889) (fiber from the needle of evergreen tree unpatentable product of nature). The second barrier was that plants were not thought amenable to patent law’s “written description” requirement. Congress addressed these issues in enacting the Plant Patent Act of 1930, 46 Stat. 703, codified at §§ 161–164, which covers new varieties of plants, but excludes tuber-propagated plants. Congress enacted a second statutory system in 1970—the Plant Variety Protection Act, codified at 7 U.S.C. §§ 2321–2582 (2012)—to protect plant varieties that are sexually reproduced by seed.

12.1 Substantive Law

12.1.1 Statutory Basis

Three forms of intellectual property protection are available for plants in the United States: (1) plant patents, (2) plant variety protection, and (3) utility patents. See Mark D. Janis, Herbert H. Jervis, & Richard Peet, *Intellectual Property Law of Plants* (2014) (discussing these regimes in U.S. and foreign law).

12.1.1.1 Plant Patent Act

The Plant Patent Act (PPA) grants patent rights to “[w]hoever invents or discovers and asexually reproduces any distinct and new variety of plant, including cultivated sports, mutants, hybrids, and newly found seedlings, other than a tuber propagated plant or a plant found in an uncultivated state” § 161. Thus, to obtain a plant patent, the statute requires that the patentee (1) invent or discover a new and distinct variety of plant and (2) asexually reproduce the plant.

The PPA affords a patentee exclusive rights over *asexually* reproduced plants. Asexual reproduction includes reproduction by layering, budding, grafting, and inarching. The PPA does not grant rights over sexually reproduced plants—plants that are reproduced from seeds or propagated from tubers (such as the Irish potato and the Jerusalem artichoke). Moreover, the PPA does not cover plants found in an uncultivated state, which has generally been interpreted as the wild. No case law to date, however, defines “uncultivated state.”

Plant patents are granted by the USPTO. Plant patents remain in effect for twenty years from the filing date of the application. Unlike utility patents, they are not subject to maintenance fees.

12.1.1.2 Plant Variety Protection Act

The Plant Variety Protection Act (PVPA) protects sexually reproduced and tuber propagated plant varieties. See §§ 2321–2582. Whereas the PPA authorizes the issuance of plant patents, the PVPA authorizes the issuance of Plant Variety Protection (PVP) certificates. PVP certificates are issued by the Secretary of Agriculture, rather than the USPTO.

A PVP certificate affords plant breeders the right “to exclude others from selling the variety, or offering it for sale, or reproducing it, or importing it, or exporting it, or using it in producing (as distinguished from developing) a hybrid or different variety” § 2483(a). A PVP certificate remains in effect for twenty years from the date of issuance, or twenty-five years in the case of a tree or vine. See § 2483(b). The United States adheres to the 1991 Convention of the International Union for the Protection of New Plant Varieties (UPOV), which the United States ratified in 1999. For an overview of UPOV systems, see generally Mark D. Janis, Herbert H. Jervis, & Richard Peet, *Intellectual Property Law of Plants*, ch. 4 (2014); see also § 12.2.4

12.1.1.3 Utility Patents

A novel plant variety can also be protected as a new “composition of matter” under the general utility Patent Act. *See* § 101. Utility patents offer the potential for broader protection for plants than do either the PPA or PVPA because utility patents can include trait claims, breeding method claims, seed deposit claims, and food product claims. For example, utility patents can protect plants bred to feature desirable traits such as heat tolerance. *See, e.g.*, U.S. Patent No. 6,294,715. Alternatively, utility patents can protect genetically engineered plants, such as plants designed to tolerate herbicide exposures, providing protection beyond the methods and tools for their production. *See, e.g.*, U.S. Patent No. 5,866,775.

Newly developed plant varieties are not limited to one statutory basis of protection. Specifically, the Supreme Court has held that neither the PPA nor the PVPA limits the scope of the coverage in § 101. *See J.E.M. Ag Supply, Inc. v. Pioneer Hi-Bred Int’l, Inc.*, 534 U.S. 124, 145 (2001). As such, sexually reproducing plants, for example, are patentable as utility patents and protectable under the PVPA.

12.1.2 The Plant Patent Claim

A plant patent consists of only one claim directed to a distinct and new variety of the plant specified, as described and illustrated in the specification, and can also recite the principal distinguishing characteristics. The claim must meet the requirements of § 101. The statute, however, relaxes the requirement of a § 112-compliant disclosure, recognizing that a written description in the case of plant patents may not enable one having skill in the art to reproduce the variety exactly. *See* § 162 (“No plant patent shall be declared invalid for noncompliance with section 112 of this title if the description is as complete as is reasonably possible.”).

A typical plant patent claim is as follows: “1. A novel and distinct variety of grapevine rootstock plant designated ‘9365-85’ having the characteristics described and illustrated herein.” *See* U.S. Patent No. PP 021,358.

12.1.3 The PVP Certificate

Unlike plant and utility patents, PVP certificates have no claims. A PVP certificate is granted for a plant variety that is new, distinct, uniform, and stable. *See* 7 U.S.C. § 2402(a) (2012).

The “new” requirement is similar in some ways to the statutory bar rule as it existed in utility patent law under the 1952 Act, § 102(b). A “new” variety “has not been sold or otherwise disposed of to other persons, by or with the consent of the breeder, or the successor in interest of the breeder, for purposes of exploitation of the variety” more than a specified period of time before the application filing date. *See* 7 U.S.C. § 2402(a)(1). If the sale or disposal is in the United States, the specified period is one year. *See* 7 U.S.C. § 2402(a)(1)(A). If the sale or disposal is outside of the United States, the specified period is four years or six years in the case of a tree or vine. *See* 7 U.S.C. § 2402(a)(1)(B).

A “distinct” variety “is clearly distinguishable from any other variety the existence of which is publicly known or a matter of common knowledge” as of the application filing date. *See* 7 U.S.C. § 2402(a)(2).

A “uniform” variety is one wherein “any variations are describable, predictable, and commercially acceptable.” *See* 7 U.S.C. § 2402(a)(3).

A “stable” variety is one, “when reproduced, will remain unchanged with regard to the essential and distinctive characteristics of the variety with a reasonable degree of reliability commensurate with that of varieties of the same category in which the same breeding method is employed.” *See* 7 U.S.C. § 2402(a)(4).

The three requirements are often referred to collectively as the “DUS” requirements. Of the three, distinctness is perhaps the most technical. It relies on comparisons between physiological or other characteristics between the varieties. To facilitate these comparisons, UPOV has developed distinctness guidelines for nearly 300 species.

12.1.4 Utility Patent Claims Related to Plants

Utility plant patent claims may include seed deposit claims, claims directed to entire or parts of plants and isolated cells, trait claims, and breeding method claims.

An example of a seed deposit claim is as follows:

Claim 1: A broccoli seed designated 393-2-19 and having ATCC Accession Number 203533.

See U.S. Patent No. 6,294,715.

An example of a claim directed at a plant and its parts is as follows:

Claim 2: A broccoli plant or its parts produced by the seed of claim 1.

See U.S. Patent No. 6,294,715.

Typical trait claims are as follows:

Claim 3: A regenerated broccoli plant regenerated from tissue culture of the broccoli plant of claim 2 wherein said regenerated plant comprises a center head having a diameter of 3 to 8 inches at maturity when said regenerated plant is exposed to a maximum temperature of at least 85° F for 15 days during the growth cycle of said regenerated plant.

Claim 4: Progeny seed produced from crossing the plant of claim 2 with another broccoli plant wherein said progeny seed produces a progeny plant comprising a center head having a diameter of 3 to 8 inches at maturity when said progeny plant is exposed to a maximum temperature of at least 85° F for 15 days during the growth cycle of said progeny plant.

See U.S. Patent No. 6,294,715.

An example of a breeding method claim is as follows:

Claim 9: A method for producing hybrid corn seed comprising the steps of a) planting in pollinating proximity seeds of corn inbred line NP982 having ATCC Accession No. 209453 and a second inbred line, not NP982.

See U.S. Patent No. 5,792,905.

12.2 Case Management

12.2.1 Plant Patents

12.2.1.1 Eligibility Requirements

Unlike the eligibility requirements for utility patents, § 161 provides that “[w]hoever invents or discovers and asexually reproduces any distinct and new variety of plant” may be eligible for a plant patent. Section 161 also specifies that the “distinct and new variety of plant” includes “cultivated sports, mutants, hybrids, and newly found seedlings” but does not include “a plant found in an uncultivated state.” Both phrases were added to the statute in 1954 in an apparent effort to resolve a controversy over whether plants found by chance and then propagated could constitute eligible subject matter for a plant patent. The language seemed to distinguish between the act of finding a plant in a cultivated plot (an act that could potentially lead to a plant patent) and finding it in the wild (an act that could not lead to a plant patent). However, in *In re Beineke*, 690 F.3d 1344 (Fed. Cir. 2012), the Federal Circuit held that the subject matter at issue was ineligible because it could not have constituted a “cultivated” sport, mutant, or hybrid, nor could it have qualified as a “newly-found seedling.” Mr. Beineke had observed two 100-year-old white oak trees growing in the front yard of a residence and had asexually reproduced these trees by planting acorns from each of these trees. *Id.* at 1346. Mr. Beineke certainly had not cultivated these trees from their inception, nor could he provide that anyone else had. According to the court, this disqualified the trees from constituting “cultivated” sports, mutants, or hybrids. Moreover, Mr. Beineke did not even attempt to argue that the mature trees were “seedlings,” so he could not rely on that category either.

12.2.1.2 Determination of Infringement of Plant Patents

The PPA grants to plant patentees “the right to exclude others from asexually reproducing the plant, and from using, offering for sale, or selling the plant so reproduced, or any of its parts, throughout the United States, or from importing the plant so reproduced, or any parts thereof, into the United States.” § 163. Each act specified in this section constitutes an independent act of infringement. *See Yoder Bros., Inc. v. Cal.-Fla. Plant Corp.*, 537 F.2d 1347, 1383 (5th Cir. 1976).

Prior to the Plant Patent Amendments Act of 1998, however, a plant patent covered the entire plant, and one did not directly infringe by selling or using the asexually reproduced plant. Congress extended the plant patent scope in 1998 to include using, offering to sell, selling, and importing an asexually reproduced plant or any of its parts. This amendment is effective for plant patents issued on or after October 27, 1998, the date the amendments were enacted. *See Pub. L. 105-289*, § 3, 112 Stat. 2781 (1998).

To prove infringement of a plant patent, the patentee must show that the alleged infringing plant resulted from asexual reproduction, i.e., that it is the progeny of the patented plant. *See Yoder*, 537 F.2d at 1380. The patentee, however, does not need to prove that one or more parts of the patented plant taken by the infringer, either directly or indirectly, actually matured into the patented plant variety. *See id.* at 1383.

Moreover, the alleged infringer does not need to know of the patent or the source of the plant. See *Kim Bros. v. Hagler*, 167 F. Supp. 665, 668 (S.D. Cal. 1958), *aff'd*, 276 F.2d 259 (9th Cir. 1960).

In determining infringement, courts consider the scope of protection of the plant patent and then compare the properly construed plant patent claim to that which is asserted to infringe. See *Imazio Nursery Inc. v. Dania Greenhouses*, 69 F.3d 1560, 1564–65 (Fed. Cir. 1995).

12.2.1.2.1 Meaning of the Term “Variety”

The meaning of the term “variety” informs the scope of protection of plant patents. Although the PPA does not specifically define the term “variety,” the statute states that new plant varieties include “cultivated sports, mutants, hybrids, and newly found seedlings.” § 161. “Sports” refers to plant varieties that result from bud variation rather than seed variation. “Mutants” refers to varieties that result from seedling variation by self-pollination of the species. “Hybrids” refers to varieties that result from seedlings of cross-pollination of two species, two varieties, or of a species and variety. “Newly found seedlings” refer to cultivated seedlings that have not previously been recognized as a new variety. See *Imazio Nursery*, 69 F.3d at 1566; see also *Ex parte Moore*, 115 U.S.P.Q. (BNA) 145, 147 (Pat. Off. Bd. App. 1957).

By contrast, the PVPA defines “variety” as a group of plants that have the same essential and distinctive characteristics. Courts, however, have rejected the argument that the term “variety” under the PPA should be interpreted in the same manner as defined under the PVPA. Even though the PPA and the PVPA both use the term “variety” and both grant some form of intellectual property protection for plant varieties, courts note that the two statutes differ significantly in their purposes.

The term “variety” in both statutes cannot be read divorced from the very different circumstances in which that term is used. Those circumstances, asexual reproduction in the case of plant patents, and sexual reproduction in the case of plant variety protection, mandate the protection afforded under these different statutory provisions.

Imazio Nursery, 69 F.3d at 1568; see also *J.E.M. Ag Supply, Inc. v. Pioneer Hi-Bred Int’l, Inc.*, 534 U.S. 124 (2001); Mark D. Janis and Stephen Smith, *Technological Change and the Design of Plant Variety Protection Systems*, 82 Chi.-Kent L. Rev. 1557 (2008).

In light of this clear difference between the PPA and the PVPA, courts have focused on the meaning of “asexual reproduction” in determining the meaning of “variety” and the scope of plant patent protection.

12.2.1.2.2 Meaning of “Asexual Reproduction”

To assert plant patent infringement, the patentee must prove that the alleged infringing plant is either a direct or an indirect asexual reproduction of the patentee’s original parent plant. A defendant does not infringe by sexually reproducing the patented plant, i.e., by reproducing the patented plant using seeds. Instead, the defendant has to physically take, either directly or indirectly, one or more parts from the

patented plant to produce the progeny of the patented plant. For example, the defendant may grow a new plant from plant cuttings or graft a new plant from buds or nodes of the patented plant variety. The plant produced from asexual reproduction is the same plant, in contrast to sexual reproduction, which produces a different plant that may be like the parent plant. *See Yoder Bros., Inc. v. Cal.-Fla. Plant Corp.*, 537 F.2d 1347, 1380 (5th Cir. 1976) (“Asexual reproduction is literally the only way that a breeder can be sure he has reproduced a plant identical in every respect to the parent.”).

A defendant, however, does not infringe by independently breeding a variety that closely resembles the characteristics of the patentee’s variety. Independent creation is a defense to plant patent infringement. *See Imazio Nursery*, 69 F.3d at 1570.

12.2.1.3 Invalidity of Plant Patents

Like utility patents, plant patents are presumed valid. *See* § 282. Furthermore, validity challenges must be proven by clear and convincing evidence. *See Cal. Table Grape Comm’n v. RB Sandrini, Inc.*, No. 1:06-cv-00842-OWW-TAG, 2007 WL 1847631, 2007 U.S. Dist. LEXIS 48362, at *35 (E.D. Cal. June 27, 2007). The same general invalidity arguments for utility patents also apply to plant patents, although § 162 relaxes the written description for plant patents. *See* §§ 14.1.1.2–14.1.1.3.

12.2.1.3.1 Anticipation

The statutory bar provisions under § 102 apply to plant patents. Specifically, the public use or sale of a plant variety one year prior to the plant patent application date will bar a plant patent. Similar to utility patent cases, however, exceptions such as secret use may apply in plant patent cases. *See, e.g., Cal. Table Grape Comm’n v. RB Sandrini, Inc.*, 2007 U.S. Dist. LEXIS 48362 (E.D. Cal. 2007). An asexually reproduced plant variety cannot be perfected or improved in an ordinary sense and consequently any use must be of the complete invention. *Bourne v. Jones*, 114 F. Supp. 413, 419 (S.D. Fla. 1951), *aff’d*, 207 F.2d 173 (5th Cir. 1953).

In *Delano Farms Co. v. California Table Grape Commission*, 778 F.3d 1243 (Fed. Cir. 2015), the Federal Circuit considered whether plant varieties were “accessible to the public” more than one year before the plant patent applications were filed. The Federal Circuit held that the cultivation of the plant varieties openly in a field was not considered accessible to the public, because the growers had knowingly obtained the plant varieties without authorization and, in this case, had agreed not to reveal that they had possession of the varieties. Further, while the growers propagated the plant varieties in locations that were visible from the public road, the vines were not labeled such that members of the public would have been able to discern these plants from others in the field. Since the purpose of the public use bar is to prevent removal from the public domain of inventions the public has come to believe are freely available, the federal court stated that such bar does not apply when the public is not informed of the inventions and cannot readily discern the claimed features.

The printed publication provisions in § 102 present a special challenge when applied to plant varieties because a written description of a new plant variety may not

be enough to enable one skilled in the art to reproduce the claimed variety. For example, the United States Court of Customs and Patent Appeals held that a publication with “a color picture of the rose clear enough to establish identity in appearance” was not an enabling disclosure of the new rose variety. See *In re LeGrice*, 301 F.2d 929, 944 (C.C.P.A. 1962) (reasoning that the instant publications were incapable of placing these roses in the public domain by their descriptions when interpreted in the light of the knowledge possessed by plant breeders). In another case, however, the Federal Circuit held that “evidence of the foreign sale of a claimed reproducible plant variety may enable an otherwise non-enabled printed publication disclosing that plant, thereby creating a § 102(b) bar.” *In re Elsner*, 381 F.3d 1125, 1128 (Fed. Cir. 2004).

12.2.1.3.2 Obviousness

Like utility patents, plant patents must also meet the nonobviousness requirement of § 103. In *Yoder*, 537 F.2d at 1378, the Fifth Circuit Court of Appeals recognized the challenge of applying the traditional three-part test for obviousness, as set out in *Graham v. John Deere Co.*, 383 U.S. 1 (1966), to plants. With respect to the first two criteria of the *Graham* framework—the scope and content of the prior art, and the differences between the prior art and the claims at issue—the Fifth Circuit noted that they could consider the characteristics of prior plants of the same general type, and the differences between the prior plants and the claims at issue. See *Yoder*, 537 F.2d at 1379. The Fifth Circuit, however, saw “no meaningful way to apply the third criterion to plants—i.e. the level of ordinary skill in the prior art.” *Id.* As a result, the Fifth Circuit applied an “invention” requirement to the obviousness analysis, recognizing that “the ‘invention’ of a new plant is the discovery of new traits *plus* the foresight and appreciation to take the step of asexual reproduction.” *Id.* at 1380 (emphasis in original). Courts have yet to address the manner and extent to which the Supreme Court’s ruling in *KSR International v. Teleflex, Inc.*, 550 U.S. 398 (2007), applies to plant patents.

12.2.1.4 Remedies Under the Plant Patent Act

All of the remedies available for utility patent infringement are available for plant patent infringement, including royalties, lost profits, injunctions, and treble damages. See §§ 161, 281–297. The calculation of damage awards and considerations of equity in plant patent infringement cases mirror the theories developed in the course of utility patent litigation. For example, courts are reluctant to award increased damages in cases where the issue of patentability is close and litigated in good faith. See *Yoder*, 537 F.2d at 1383.

12.2.2 Plant Variety Protection

12.2.2.1 Determination of Infringement Under the PVPA

To prove infringement of a PVP certificate, the plaintiff must show by a preponderance of the evidence that the defendant committed one or more of the acts con-

stituting infringement defined in 7 U.S.C. § 2541. See *Delta & Pine Land Co. v. The Sinkers Corp.*, 177 F.3d 1343, 1347 (Fed. Cir. 1999). Infringing acts include, for example, selling, importing, or exporting novel plant varieties.

Furthermore, a plaintiff must show marking or actual notice. See 7 U.S.C. § 2567. Thus, a plaintiff can only sue under the PVPA once the variety is distributed with notice of PVP pending or after the PVP certificate issues. See *Syngenta Seeds v. Delta Cotton Co-operative, Inc.*, 457 F.3d 1269, 1276 (Fed. Cir. 2006).

12.2.2.1.1 Essentially Derived Varieties

Unlike the utility patent system, the PVPA affords certificate holders little scope beyond the “disclosed embodiment.” Although infringement of PVP certificates may extend to a variety “essentially derived from a protected variety” under 7 U.S.C. § 2541(c), this provision does not operate analogously to patent law’s doctrine of equivalents.

This “essentially derived” provision prevents infringers from escaping liability merely by making trivial changes to a protected variety. In other words, the “essentially derived infringement” provision prevents one party from identifying a successful PVPA-protected variety, altering a nonessential characteristic of that PVPA-protected variety, and then undercutting the PVPA-holder’s rights by selling the copy.

The statute defines “essentially derived variety” as a variety that “is predominantly derived from another variety or from a variety that is predominantly derived from the initial variety, while retaining the expression of the essential characteristics that result from the genotype or combination of genotypes of the initial variety.” 7 U.S.C. § 2401(a)(3)(A)(i). The statute specifies that the PVPA infringement provisions extend not only to the protected variety, but also to “any variety that is essentially derived from a protected variety, unless the protected variety is an essentially derived variety.” 7 U.S.C. § 2541(c)(1). In other words, the PVPA establishes two tiers of protection: an initial variety “A” (meaning a variety that is not essentially derived from other varieties) gets PVPA protection for all EDVs of that variety (A(1), A(2), A(3), etc.); while an essentially derived variety (A(2), for example) does not get PVPA protection for varieties essentially derived from it (and so would not get protection over A(3), for example). This is referred to as a principle of limited dependency. See Mark D. Janis, Herbert H. Jervis, & Richard Peet, *Intellectual Property Law of Plants*, ¶¶ 4.95–4.106.

12.2.2.1.2 PVPA Exemptions

The PVPA exempts various acts that might otherwise be considered infringement under § 2541. See 7 U.S.C. §§ 2542–2545.

Section 2542, known as the “Grandfather Clause,” authorizes a person to reproduce or sell a plant variety if he or she developed that variety more than one year before the effective filing date of the adverse application for a PVP certificate. For this section to apply, the person must at least have a good-faith claim to the seed variety at issue or be a successor in interest to the original developer. See *N. Star Genet-*

ics, Ltd. v. Bata, No. CIV. A3-00-57, 2001 WL 1820380, 2001 U.S. Dist. LEXIS 20065, at *5–6 (D.N.D. Aug. 9, 2001).

Section 2543 is the “saved seed” provision, also known as the crop exemption, and authorizes a person to save seeds of a legally purchased plant variety, if the seed is replanted on the purchaser’s own property. The current provision came into effect in 1995 as a result of 1994 legislation. Prior to that time, some growers took the position that the saved seed exemption permitted growers to save and resell seed in unlimited amounts to other farmers, but that view was rejected even under the pre-1994 version of the provision in *Asgrow Seed Co. v. Winterboer*, 513 U.S. 179 (1995).

Section 2544, usually referred to as the breeder’s exemption, exempts from infringement the “use and reproduction of a protected variety for plant breeding and other bona fide research.” Because the PVPA includes a separate provision exempting “any act done privately and for noncommercial purposes,” 7 U.S.C. § 2541(e), it is clear that the breeder’s exemption extends to commercial activity in the form of plant breeding using a protected variety to create another variety. This section has been interpreted to permit a breeder’s competitor to use the protected seed to create new varieties without permission. See *Monsanto Co. v. Byrd*, No. 7:99-CV-154-F1, 2000 WL 33952260, 2000 U.S. Dist. LEXIS 22793, at *10 (E.D.N.C. Dec. 11, 2000).

Section 2545 is directed to carriers and advertisers, the scope of which has yet to be determined by courts.

12.2.2.2 Invalidity of PVP Certificates

Similar to a utility or plant patent, a PVP certificate enjoys a presumption of validity. See 7 U.S.C. § 2561 (“If a variety is sold under the name of a variety shown in a certificate, there is a prima facie presumption that it is the same variety.”). As a defense to infringement, the defendant bears the burden to establish invalidity of the PVP certificate. See *Genecorp, Inc. v. Progeny Advanced Genetics, Inc.*, No. C 97-20706 RMW, 1998 WL 1108155, 1998 U.S. Dist. LEXIS 21910, at *12–13 (N.D. Cal. Apr. 14, 1998).

12.2.2.3 Remedies Under the PVPA

Courts may issue an injunction under 7 U.S.C. § 2563, as well as award monetary damages, treble damages, and reasonable attorney fees under 7 U.S.C. § 2564. See, e.g., *Heart Seed Co. v. Seeds, Inc.*, No. C-84-336-SPM, 1987 WL 41982, 1987 U.S. Dist. LEXIS 13969, at *9–10 (E.D. Wash. Jan. 29, 1987) (discussing injunctive relief, reasonable royalty, lost profits, treble damages, and attorney fees); *Bud Antle, Inc. v. Scattini Seed Co.*, No. C-85-20699-WAI, 1985 WL 6440, 1985 U.S. Dist. LEXIS 12587, at *6–8 (N.D. Cal. Dec. 20, 1985). Courts, however, are precluded from awarding damages for infringement prior to the issuance of the PVP certificate if the court finds that the infringer had innocent intentions. See 7 U.S.C. § 2564(d); see also *BASF Agrochemical Prods. v. Unkel*, No. 05 CV 1478, 2006 WL 3533133, 2006 U.S. Dist. LEXIS 88672, at *16 (W.D. La. Dec. 7, 2006).

12.2.3 Utility Patent Issues Related to Plants

As discussed in previous chapters, courts will often have to determine infringement or invalidity of a utility patent. Recent utility patent cases involving plants have also focused on several important patent law doctrines, including exhaustion, tying and patent misuse, and indirect infringement.

12.2.3.1 Patent Exhaustion

In *Monsanto Co. v. McFarling (McFarling I)*, 302 F.3d 1291, 1299 (Fed. Cir. 2002), the Federal Circuit held that the first sale doctrine of exhaustion of the patent right was not implicated where new seeds grown from the original batch had never been sold. *Id.* Specifically, the original sale of the seeds did not confer a license to construct new seeds. Since the new seeds were not sold by the patentee, they entailed no principle of patent exhaustion. *Id.*

In *Bowman v. Monsanto*, 133 S. Ct. 1761 (2013), the Supreme Court affirmed the Federal Circuit's holding that one who purchases patented seeds may not "reproduce them through planting and harvesting without the patent holder's permission." The *Bowman* case involved the use of genetically modified soybean seeds. *Id.* at 1764. Soybeans are considered "self-replicating," because when soybean seeds are planted, additional soybean seeds are produced, and each new generation of soybean seeds will have substantially the same traits as the previous generation. *Id.* at 1768–69. This is because soybeans tend to be self-pollinating.

The Supreme Court rejected Bowman's argument that the authorized sale of a product exhausted Monsanto's patent rights in the product. According to the Court, the exhaustion doctrine "restricts a patentee's rights only as to the 'particular article' sold; it leaves untouched the patentee's ability to prevent a buyer from making new copies of the patented item." *Id.* at 1766. The Court rejected the argument that exhaustion applied because the seeds in question naturally self-replicate unless stored in a controlled manner and thus it was the soybeans and not Bowman that caused the invention to be practiced. The Court dismissed the "blame-the-seed" defense, noting that Bowman saved the seeds for replanting and replanted them, thereby controlling the reproduction of Monsanto's patented invention. *See id.* at 1768–69. The Court noted, however, that its holding was limited to these facts and did not necessarily govern how the exhaustion doctrine would apply to other self-replicating technologies. *See id.* at 1769.

12.2.3.2 Patent Misuse

The Federal Circuit addressed the issue of tying and patent misuse in *Monsanto Co. v. McFarling (McFarling II)*, 363 F.3d 1336 (Fed. Cir. 2004). The court held that a contractual prohibition on the replanting of second generation seeds does not impermissibly extend a patentee's rights, where the patent at issue also reads on the second and all subsequent generations of seeds. *See id.* at 1343.

12.2.3.3 Indirect Infringement

Courts have also found indirect patent infringement of utility plant patents under an inducement theory. For example, the Northern District of Indiana addressed the issue of inducement in a plant case, holding that the cleaning of patent-protected seeds in furtherance of unauthorized replanting constituted an inducement of patent infringement. *See Monsanto Co. v. Parr*, 545 F. Supp. 2d 836, 842 (N.D. Ind. 2008) (issuing a permanent injunction to halt the unauthorized seed cleaning).

12.2.4 Other Plant-Related IP Issues: Variety Names and Trademarks

When dealing with plant-related intellectual property cases, courts often encounter variety name and trademark issues.

When a new plant variety is developed, the varietal name for the new variety is differentiated from a trademark or brand that is intended to be used ultimately to market the variety. The Convention of the International Union for the Protection of New Plant Varieties (UPOV), to which the United States is a party, requires that “each new plant variety shall be designated by a denomination which will be its generic designation.” *See* Convention of the International Union for the Protection of New Plant Varieties, art. 20, Mar. 19, 1991, U.S.T. 104–17 [hereinafter UPOV]. UPOV further requires that each member of the Union register the generic designation of the new plant variety at the same time it issues the protection for the new variety. *Id.* Accordingly, under United States law, the generic or varietal designation must be listed in the plant patent application or application for a PVP certificate covering the new plant material. *See* USPTO, Manual of Patent Examining Procedure § 1612 (8th ed. 2010); *see also* U.S. Department of Agriculture, Agricultural Marketing Service, <http://www.ams.usda.gov> (providing information about the USDA guidelines for PVP applications).

UPOV provides criteria on the selection of the new varietal, which requires that it (1) not mislead or cause confusion concerning the nature of the variety of the identity of the breeder, (2) not interfere with prior rights of third parties, including trademark rights of third parties, and (3) differs from all other denominations used by other members of UPOV for the same or closely related categories of plants. UPOV, art. 20. Examination of varietal names is somewhat *ad hoc* in the United States as there is no registry of all varietal name designations that exist in the United States. UPOV has a database on CD-ROM of varietal names designated in plant variety protection applications that can be ordered from the UPOV site. *See* International Union for the Protection of New Varieties of Plants, <http://www.upov.int>. In addition, there are various databases specific to certain plant categories that may be examined to help locate conflicts.

The USPTO examiners will review the UPOV database and United States patent and trademark filings to determine whether a varietal designation can be accepted. Likewise, the USDA will “pre-clear” a varietal name intended to be included in an application for a PVP certificate. The failure of the USPTO or USDA to identify a

conflict does not insulate the applicant from a challenge from a third party who might object to the use of the varietal name on the ground that it conflicts or causes confusion with respect to an existing varietal designation or trademark right.

While patent and PVP certificate holders may have exclusivity of use of the generic designation while the rights of the PVP or patent are valid and only those rights holders can market and sell the protected variety, when those rights expire the generic or varietal designation may be used by competitors in connection with their own use and sale of the formerly protected varietal. See *In re KRB Seed Co.*, 76 U.S.P.Q.2d (BNA) 1156 (T.T.A.B. 2005) (recognizing that the PVPA and UPOV require that once a breeder's protection period for a new plant expires, those who sell plants must be able to call the plant by its varietal name so that consumers will know what they are buying). It is not possible to extend the exclusivity in using the generic designation beyond the life of the plant protection by asserting trademark rights in the varietal designation. UPOV, art. 20 ("Each contracting state shall ensure that . . . no rights in the designation registered as the denomination of the variety shall hamper the free use of the denomination in connection with the variety, even after expiration of the breeder's right.").

Any application to register a trademark relating to a plant or varietal that consists of a term that was used as the varietal designation in a PVP certificate or plant patent for that plant or varietal will be rejected by the USPTO. See USPTO, Trademark Manual of Examining Procedure § 1202.12 (7th ed.) ("If the examining attorney determines that wording sought to be registered as a mark for live plants, agricultural seeds, fresh fruits or vegetables comprises a varietal or cultivar name, then the examining attorney must refuse registration, or require a disclaimer, on the ground that the matter is a varietal name of the goods and does not function as a trademark . . ."); see also *In re Pennington Seed, Inc.*, 466 F.3d 1053 (Fed. Cir. 2006) (affirming the USPTO's refusal to register REBEL as a trademark for use on grass and grass seed owing to the fact that REBEL was designated in a PVP certificate as varietal name, despite evidence of extensive marketing and advertising of term by applicant).

Chapter 13

Patent Suits Against the United States

- 13.1 Introduction 1
 - 13.1.1 Legal Foundation 1
 - 13.1.2 United States Court of Federal Claims 2
 - 13.1.2.1 History 2
 - 13.1.2.2 General Statistics 3
- 13.2 Jurisdiction 3
 - 13.2.1 Scope of § 1498 3
 - 13.2.1.1 Historical Development 3
 - 13.2.1.2 Authorization and Consent 4
 - 13.2.2 Interplay with District Court Jurisdiction 6
 - 13.2.2.1 Section 1500's Bar on Simultaneous Suits 6
 - 13.2.2.2 Section 1498 as a Defense 6
- 13.3 Substantive Differences Between Patent Suits in District Court and the Court of Federal Claims 7
 - 13.3.1 Infringement 7
 - 13.3.2 Third-Party Practice 7
 - 13.3.3 Damages 8
 - 13.3.4 Costs and Attorney Fees 9
- 13.4 Early Case Management 9
- 13.5 Discovery 10

13.1 Introduction

13.1.1 Legal Foundation

For over a century, 28 U.S.C. § 1498 (2012) has allowed patent owners to assert patents against the United States for unauthorized use of patented inventions. Patent infringement claims against the United States are based in eminent domain, not tort.¹ Although patent infringement has long been understood as a tort, the United States has not consented to be sued for patent infringement on a tort theory. See *Schillinger v. United States*, 155 U.S. 163 (1894). And, as a sovereign entity, the United States is immune from suit without consent. See *United States v. Mitchell*, 445 U.S. 535, 538 (1980). Congress has instead “authorize[d] the Government to take, through exercise of its power of eminent domain, a license in any United States patent.” *Decca Ltd. v. United States*, 640 F.2d 1156, 1166 (Ct. Cl. 1980). “[T]he sole

1. See *Leesona Corp. v. United States*, 599 F.2d 958 (Ct. Cl. 1979); see also *Crozier v. Fried. Krupp Aktiengesellschaft*, 224 U.S. 290, 307 (1912) (“[W]e think there is no room for doubt that [Section 1498] makes full and adequate provision for the exercise of the power of eminent domain for which considered in its final analysis it was the purpose of the statute to provide.”); *Motorola, Inc. v. United States*, 729 F.2d 765, 768 (Fed. Cir. 1984) (“This is a 28 U.S.C. § 1498 action, and as such, the patent owner is seeking to recover just compensation for the Government’s unauthorized taking and use of his invention. The theoretical basis for his recovery is the doctrine of eminent domain.”); *Irving Air Chute Co. v. United States*, 93 F. Supp. 633, 635 (Ct. Cl. 1950) (“The Government urges, rightly, that 28 U.S.C.A. § 1498, is in effect, an eminent domain statute . . .”).

remedy available to a patentee for an eminent domain taking of a license in his patent” is an action for monetary recovery under § 1498. *Id.* That action must be brought in the United States Court of Federal Claims.

13.1.2 United States Court of Federal Claims

The United States Court of Federal Claims is an Article I court, with judges appointed to fifteen-year terms. Because there are no juries in the Court of Federal Claims, all patent cases are tried to the bench. Although the court is based in Washington, D.C., it has nationwide jurisdiction and subpoena power. Accordingly, it can, and often does, sit anywhere in the nation that makes sense—given the location of trial witnesses—to minimize plaintiffs’ expenses. The court has also scheduled sessions out of town to hear a group of witnesses, such as those called in the plaintiff’s case, and then reconvened in Washington, D.C., to hear the government’s witnesses. When the court sits outside of Washington, D.C., it borrows other districts’ courtrooms.

13.1.2.1 History

The U.S. Court of Federal Claims traces its existence to its predecessor, the United States Court of Claims,² which was created by the Act of February 24, 1855. Ch. 122, 10 Stat. 612 (1855) (amended by the Act of March 3, 1863, 12 Stat. 765 (1863) to permit the court to issue final judgments). The Court of Claims was intended to relieve pressure on Congress from claimants’ requests for private bills providing for relief. See Stanton J. Peelle, *History and Jurisdiction of the United States Court of Claims*, 19 Recs. of the Colum. Hist. Soc. 1 (1916). At that time, however, it consisted of three judges who would investigate claims and provide proposed legislation to Congress to pay claims. James F. Davis, *U.S. Court of Claims Patent Practice* 2 (3d ed. Patent Res. Grp. 1970); see also *Pocono Pines Assembly Hotels Co. v. United States*, 73 Ct. Cl. 447 (1932). Thus, as originally established, it lacked the judicial power to enter judgments.

In the Act of March 3, 1863, at the urging of President Lincoln, Congress empowered the Court of Claims to adjudicate claims and enter judgments. 12 Stat. 765 (1863). It also increased the size of the court to four associate judges and a chief judge. See *Pocono Pines*, 73 Ct. Cl. at 467–68. In 1887, Congress passed the Tucker Act, which firmly established the Court of Claims’ jurisdiction to hear cases arising under implied or express contracts, or under the Constitution or any statute, not

2. The United States Court of Appeals for the Federal Circuit also traces its existence to the Court of Claims. See Federal Courts Improvement Act of 1982, Pub. L. No. 97-164, § 133, 96 Stat. 40 (1982). The Federal Circuit assumed the appellate functions of the Court of Claims, while its trial responsibilities were passed on to the Court of Federal Claims (which was formerly known as the United States Claims Court). See *id.* §§ 101, 105(a), 96 Stat. 25, 27; Federal Courts Administration Act of 1992, Pub. L. No. 102-572, § 902, 106 Stat. 4506, 4516 (1992).

sounding in tort. Ch. 359, § 1, 24 Stat. 505 (1887) (codified at 28 U.S.C. § 1491 (2012)).

13.1.2.2 General Statistics

During fiscal year 2014, the Court of Federal Claims disposed of 703 complaints, as well as 562 petitions filed under the vaccine compensation program. *Report to the Administrative Office of U.S. Courts for FY 2014*, available at <http://www.uscfc.uscourts.gov/sites/default/files/AO2014Stats.pdf>. The total amount of judgments rendered by the court was nearly \$13 billion. *Id.* In addition to monetary judgments, the court disposed of 124 contract cases in which injunctive or declaratory relief was sought. *Id.*

While the bulk of the court's caseload consists of contract cases (not including vaccine cases, which are handled by special masters), there were eighteen copyright and patent cases filed in Fiscal Year (FY) 2014. During FY 2014, there were fifteen copyright and patent cases disposed of, leaving thirty-eight such cases pending. *Id.* at 2.

There are eleven active judges on the Court of Federal Claims, along with seven senior judges. See *Judges – Biographies*, Fed. Cl., available at <http://www.uscfc.uscourts.gov/judicial-officers> (last visited Feb. 4, 2016). There are pending nominations for four others to become active judges. See U.S. Senate, *Judicial Nominations*, available at <http://www.judiciary.senate.gov/nominations/judicial> (last visited Feb. 4, 2016).

13.2 Jurisdiction

13.2.1 Scope of § 1498

Section 1498 confers upon the Court of Federal Claims exclusive jurisdiction for patent infringement actions against the United States. See *Crater Corp. v. Lucent Techs. Inc.*, 255 F.3d 1361, 1364 (Fed. Cir. 2001). This includes jurisdiction over use or manufacture of a patented invention “by” or “for” the United States. A government contractor's use of an invention shall be deemed use “for” the United States if the use was “for the Government and with the authorization and consent of the Government.” 28 U.S.C. § 1498(a).

13.2.1.1 Historical Development

Prior to 1910, the Court of Claims did not have jurisdiction to hear patent infringement claims. 12 Stat. 765 (1863). While the Court of Claims had heard cases founded upon an implied contract with the patent owner under which an agreement to pay for use of an invention could be inferred, it lacked jurisdiction to hear general claims of patent infringement by the government. *Leesona Corp. v. United States*, 599 F.2d 958, 966 (Ct. Cl. 1979). In *Schillinger v. United States*, 155 U.S. 163 (1894), the Court held that patent infringement was a tort for which the Court of Claims lacked jurisdiction, and also held that it was not cognizable as a Fifth Amendment takings claim.

In 1910, Congress established a remedy for the recovery of reasonable compensation whenever an invention described in and covered by a patent was used by the United States without authorization or lawful right. 36 Stat. 851 (1910). Consistent with the Court of Claims' jurisdiction to render money judgments against the government, the remedy provided was reasonable compensation and not injunctive relief. See *Leesona*, 599 F.2d at 966–67. This remedy is based on the government's eminent domain power to take property, and reasonable compensation has been viewed as equivalent to just compensation under the Fifth Amendment. *Id.* at 967.

The Act of 1910, however, left the government's contractors also exposed to infringement suits, which could result in an injunction that could delay or prevent the government from obtaining needed materials or supplies. See *Cramp & Sons v. Int'l Curtis Marine Turbine*, 246 U.S. 28 (1918) (enjoining government contractor). During World War I, naval manufacturers expressed concern about patent infringement suits. See *Zoltek Corp. v. United States*, 672 F.3d 1309, 1315–16 (Fed. Cir. 2012). Acting Secretary of the Navy Franklin D. Roosevelt observed that these manufacturers faced the threat of “prohibitive injunction payment of royalties” and “punitive damages,” instead of the “just and adequate compensation” available to patentees in the Court of Claims. *Id.* Congress reacted quickly, amending the Act of 1910:

[W]henever an invention described in and covered by a United States patent shall . . . be used or manufactured by or for the United States without . . . lawful right . . . such owner's remedy shall be by suit in the United States Court of Claims for the recovery of his reasonable and entire compensation for such use and manufacture.

Act of July 1, 1918, Pub. L. No. 65-182, 40 Stat. 704, 705 (1918). In providing this remedy, Congress sought to avoid harm to the war effort by providing that the entire remedy for unauthorized use or manufacture of a patented invention lay against the government for the recovery of reasonable compensation. See *Leesona*, 599 F.2d at 967.

Courts considering claims under the Act of 1918 voiced some concerns over the government being subjected to liability for patent infringement that it did not intend. This led to the concept of authorization or consent as a limitation on the extent to which a government contractor might be insulated from any private suit for patent infringement. See *Wood v. Atl. Gulf & Pac. Co.*, 296 F. 718 (S.D. Ala. 1924). In turn, statutory language was added to § 1498(a) stating that

the use or manufacture of an invention described in and covered by a patent of the United States by a contractor, subcontractor, or any person, firm or corporation for the Government and with the authorization or consent of the Government, shall be construed as use or manufacture for the United States.

13.2.1.2 Authorization and Consent

A common way to confer authorization and consent is to include a provision in the contract, which is required to be included (“flowed down”) in subcontracts. The Federal Acquisition Regulations (FAR) prescribe two main authorization and consent provisions—a broad one used for research and development contracts, and a

narrower one for procurement contracts. The “broad clause,” referred to as FAR 52.227-1 Alternate I, is required for R&D contracts and simply confers authorization and consent for “all manufacture and use” of a patented invention in performance of the contract or any subcontract. The narrower clause in FAR 52.227-1 applies to contracts for procurement of supplies or services, and in its current form provides authorization and consent for manufacture or use of any patented invention (1) embodied in an article delivered to and accepted by the government, or (2) resulting from use of machinery, tools, methods required by contract specs and provisions, or a contracting officer’s written direction.

In the absence of an express contractual provision, authorization and consent can be implied only in limited circumstances “where particular government specifications required a particular patent infringement.” *Windsurfing Int’l v. Ostermann*, 534 F. Supp. 581, 588 (S.D.N.Y. 1982); *see also Auerbach v. Sverdrup Corp.*, 829 F.2d 175, 177 (D.C. Cir. 1987) (“[T]he government waiver of immunity by authorization and consent requires explicit acts or extrinsic evidence sufficient to prove the government’s intention to accept liability for a specific act of infringement.”); *Larson v. United States*, 26 Cl. Ct. 365, 368–69 (1992) (same). “[I]f the government requirements can be satisfied without an infringement, authorization or consent [for patent infringement] will not be implied,” *Windsurfing Int’l*, 534 F. Supp. at 588, because “governmental waivers of liability must be construed narrowly,” *Auerbach*, 829 F.2d at 179. Further, authorization and consent will not be implied if the governmental benefit from infringement is “too remote.” *See Windsurfing Int’l*, 534 F. Supp. at 588 (holding that the government’s general interest in the success of the Olympic Games was “simply too remote from the purposes underlying § 1498 to support the conclusion that the use of sailboards [at the Games] is use ‘for’ the United States entitling the patentee to sue the government for compensation.”); *Larson*, 26 Cl. Ct. at 368–69 (holding that the federal government’s general interest in Medicare did not mean that medical devices used to treat Medicare patients were used “for” the government); *see also Riles v. Amerada Hess Corp.*, 999 F. Supp. 938, 940 (S.D. Tex. 1998) (holding that even though the federal government had a national interest in developing public lands and derived a royalty from a lease for private drilling on those public lands, the drilling was not performed “for the government” under § 1498 because “the primary purpose of § 1498(a) is to allow the United States Government to purchase goods and services for performance of Governmental functions”).

Where the government has accepted delivery of and used an allegedly infringing device, however, courts have found implied authorization and consent. *See, e.g., Stelma, Inc. v. Bridge Elec. Co.*, 300 F.2d 761, 762 (3d Cir. 1962); *Bereslavsky v. ESSO Standard Oil Co.*, 175 F.2d 148, 151 (4th Cir. 1949); *Croydon Co., Inc. v. Unique Furnishings, Ltd.*, 831 F. Supp. 480, 484–85 (E.D.N.C. 1993). *See generally* 5 Donald Chisum, *Chisum on Patents*, § 16.06[3][c] at 16–289 (2004). In such a case, the government could be subject to suit under § 1498 for its use of an allegedly infringing device, so these holdings avoid the prospect of the government’s supplier also being subject to suit for making the device that was delivered to the government.

Finally, courts have found authorization and consent where the government has intervened in an action and asserts that authorization and consent exists. *See Ad-*

vanced Software Design Corp. v. Fed. Reserve Bank of St. Louis, 583 F.3d 1371, 1377–78 (Fed. Cir. 2009); *see also IRIS Corp. v. Japan Airlines Corp.*, 769 F.3d 1359, 1362 (Fed. Cir. 2014) (holding that authorization and consent existed where the government agreed that the statute required performance of allegedly infringing activities).

13.2.2 Interplay with District Court Jurisdiction

13.2.2.1 Section 1500’s Bar on Simultaneous Suits

One aspect of litigating patent claims against the government that differs from private infringement actions is 28 U.S.C. § 1500, which prevents a plaintiff from simultaneously pursuing cases “based on substantially the same operative facts” in multiple jurisdictions against the United States or its proxy. *United States v. Tohono O’Odham Nation*, 131 S. Ct. 1723, 1731 (2011). The statute provides:

The United States Court of Federal Claims shall not have jurisdiction of any claim for or in respect to which the plaintiff or his assignee has pending in any other court any suit or process against the United States or any person who, at the time when the cause of action alleged in such suit or process arose, was, in respect thereto, acting or professing to act, directly or indirectly under the authority of the United States.

28 U.S.C. § 1500.

The combined effect of §§ 1498 and 1500 can limit plaintiffs’ abilities to seek redress for injuries. For example, in *Croydon Co., Inc. v. Unique Furnishings, Ltd.*, 831 F. Supp. 480 (E.D.N.C. 1993), a plaintiff asserted claims against a government contractor for violating its patent rights, the Lanham Act, and state unfair-competition laws. The court held that it could not hear the patent count because § 1498 vested the Court of Federal Claims with exclusive jurisdiction over patent claims. *Id.* at 486–87. Section 1500, however, prevented the court from transferring the patent count to the Court of Federal Claims while the Lanham Act and unfair competition counts remained pending in the district court because all three counts arose out of the same operative facts. *Id.* at 489–90.

In *Trusted Integration, Inc. v. United States*, 659 F.3d 1159 (Fed. Cir. 2011), however, the Federal Circuit held that a previously filed district court complaint against the government, which alleged Lanham Act and breach of fiduciary duty counts, created a § 1500 bar to a suit in the Court of Federal Claims for counts alleging breach of implied contract and breach of the duty of good faith, but did not bar the suit from proceeding on a breach of express contract count. While there was some overlap in the allegations pleaded in both actions, the Federal Circuit held that the allegations in the district court complaint would not have sufficed to establish liability for the surviving count of the Court of Federal Claims action. *See id.* at 1170.

13.2.2.2 Section 1498 as a Defense

Government contractors sued outside the Court of Federal Claims can assert § 1498 as an “affirmative defense rather than a jurisdictional bar” to suit. *Toxgon Corp. v. BNFL, Inc.*, 312 F.3d 1379, 1381 (Fed. Cir. 2002). *But see O’Rourke v. Smith-*

sonian Inst. Press, 399 F.3d 113, 123 (2d Cir. 2005) (affirming dismissal based on lack of subject-matter jurisdiction).

13.3 Substantive Differences Between Patent Suits in District Court and the Court of Federal Claims

In § 1498(a) actions for unauthorized use or manufacture of a patented invention, the Court of Federal Claims applies the same principles and substantive law that governs private patent infringement actions. *Lemelson v. United States*, 752 F.2d 1538, 1548 (Fed. Cir. 1985). Many of the procedural practices in pretrial disclosure of infringement and invalidity contentions, and *Markman* hearing practice in the Court of Federal Claims, are similar, if not identical, to those used by district courts. However, the eminent domain underpinnings of § 1498 actions lead to several substantive differences between patent infringement actions in district courts and those in the Court of Federal Claims.

13.3.1 Infringement

Infringement suits against the government under § 1498 are limited to the types of infringement over which the government has consented to suit. *See, e.g., Motorola, Inc. v. United States*, 729 F.2d 765, 769 n.3 (Fed. Cir. 1984) (holding that the United States has not consented to indirect infringement suits brought under 35 U.S.C. § 271(b) & (c) (2012)). The limited nature of this sovereign immunity waiver leaves open the possibility that a patentee may have no statutory remedy for acts defined as infringement under § 271 that do not find corresponding language in 28 U.S.C § 1498(a).

It is unsettled whether the Fifth Amendment provides such a patentee with a constitutional remedy. The Federal Circuit held that there was no Fifth Amendment remedy for such infringement. *Zoltek Corp. v. United States*, 442 F.3d 1345 (Fed. Cir. 2006), *vacated on other grounds, Zoltek Corp. v. United States*, 672 F.3d 1309, 1317 (Fed. Cir. 2012) (en banc in part). The reasoning contained in the now-vacated panel decision has been criticized for applying an obsolete understanding of the Fifth Amendment. *See* Justin Torres, Note, *The Government Giveth and The Government Taketh Away: Patents, Takings, and 28 U.S.C. § 1498*, 63 NYU Annual Survey of Am. L. 315 (2008). On the other hand, the government, in opposing a petition for certiorari from the *Zoltek* panel decision contended, *inter alia*, that because patent rights are a creature of federal statute, any statutory limitations on them define the property right, rather than constitute a taking of some preexisting right. Brief for the United States in Opposition at 19, *Zoltek Corp. v. United States* (No. 06-1155), available at <http://www.justice.gov/sites/default/files/osg/briefs/2006/01/01/2006-1155.resp.pdf>.

13.3.2 Third-Party Practice

Although the government assumes the liability of its contractors through § 1498, many contractors in turn indemnify the government for patent infringement. Court

of Federal Claims Rule 14 offers a mechanism for providing notice to interested parties, such as third-party indemnitors. Because indemnitors may be bound by infringement and validity determinations reached in the Court of Federal Claims, government contractors frequently elect to join the case as third-party defendants by filing answers and asserting affirmative defenses. Third-party defendants, however, are not permitted to assert counterclaims. *Rolls-Royce Ltd. v. United States*, 364 F.2d 415, 417–18 (Ct. Cl. 1966).

The Federal Circuit, in *In re Uusi LLC*, 549 F. App'x 964 (Fed. Cir. 2013), reaffirmed the vitality of Rule 14(b) as a means of providing notice to a potentially interested third-party and affording an opportunity to enter the case, even though the prior statute that explicitly authorized this procedure, 41 U.S.C. § 114(b) (2012), had been repealed when Title 41 was reenacted.

In this regard a third-party defendant, while it may participate in the defense of a § 1498 action, has a more limited role than a third-party defendant has in a private infringement action. *In re Uusi*, 549 F. App'x at 967 (citing *Penda Corp. v. United States*, 44 F.3d 967, 970–71 (Fed. Cir. 1994)). The government will retain control of the litigation, as required by 28 U.S.C. § 516, but the third-party defendant can offer additional evidence and advance arguments on its behalf. See *Penda*, 44 F.3d at 970. A third-party defendant may not, however, appeal from an adverse judgment of the Court of Federal Claims where the government has declined to appeal. See *id.* at 971.

13.3.3 Damages

Section 1498's roots in eminent domain limit the damages theories available to patentees in the Court of Federal Claims. Damages claims under § 1498 usually cannot be based on the benefit the patented invention conferred on the government because “the proper measure in eminent domain is what the owner has lost, not what the taker has gained.” *Leesona*, 599 F.2d at 969; *Dow Chem. Co. v. United States*, 226 F.3d 1334, 1338 (Fed. Cir. 2000). Thus, a reasonable royalty is the normal measure of compensation in § 1498 actions. Although lost profits have not been awarded in a § 1498 action since the 1930's, the Federal Circuit in *Gargoyles, Inc. v. United States*, 113 F.3d 1572, 1575–77 (Fed. Cir. 1997), declined to hold that lost profits could never be awarded in a § 1498 action.

Section 1498 establishes that patentees are entitled to “reasonable and entire compensation” for the unauthorized use of their inventions. That standard has been equated to just compensation under the Fifth Amendment, in light of the eminent domain foundation of § 1498. See *Motorola*, 729 F.2d at 768, n.3. Thus, reasonable compensation would include compensation for the taking of the patent license, normally in the form of a reasonable royalty, along with “delay compensation” as remuneration for the government's delay in taking the license. See *Decca Ltd. v. United States*, 640 F.2d 1156, 1167–68 (Ct. Cl. 1980). However, enhanced damages for willful infringement are not available against the government, and willfulness is not an issue in § 1498 cases. See *Leesona*, 599 F.2d at 969.

In determining a reasonable royalty, the Court of Federal Claims has considered the likely outcome of a hypothetical negotiation and weighed evidence relating to the

Georgia-Pacific factors. See *Gargoyles*, 113 F.3d at 1580–81. In this regard, a determination of a reasonable royalty in § 1498 cases parallels the same determination in a private infringement action. See § 14.4.3.2.1.4. Likewise, when plaintiffs have sought lost profits as the measure of reasonable compensation, the Court of Federal Claims has examined the various factors set forth in *Panduit Corp. v. Stahl Bros. Fibre Works*, 575 F.2d 1152, 1156 (6th Cir. 1978) (the *Panduit* factors). See, e.g., *Gargoyles*, 113 F.3d at 1577–79.

13.3.4 Costs and Attorney Fees

Section 1498(a) provides for an award of reasonable costs, including attorney and expert witness fees, to certain plaintiffs prevailing in patent cases. The award of reasonable costs is provided to successful claimants who are independent inventors, non-profit organizations, or entities having fewer than 500 employees during the five years preceding the date when the government first manufactured or used the patented invention.

However, where the action has been pending in the Court of Federal Claims for ten years or less, the statute only raises a presumption of entitlement to reasonable costs and attorneys' fees. The government may rebut this presumption by showing that the position of the United States was substantially justified or that specific circumstances exist that would make such an award unjust. The presumption of entitlement and the showing that is necessary to overcome that presumption are identical to the provisions of the Equal Access to Justice Act. See 28 U.S.C. § 2412(d). The presumption becomes irrebuttable when the case has been pending before the court for more than ten years.

The award of reasonable costs under § 1498 is made as part of the “reasonable and entire compensation” awarded for the government’s manufacture or use of the patented invention. As such, the award of reasonable costs is made as part of a comprehensive judgment on the merits and not the result of a separate proceeding.

13.4 Early Case Management

The Court of Federal Claims has its own rules (RCFC), which largely mirror the Federal Rules of Civil Procedure. The current set of rules is available at <http://www.uscfc.uscourts.gov/rules>. RCFC 16 governs the Court of Federal Claims’ scheduling and early case management. It, in turn, refers to submission of a Joint Preliminary Status Report (JPSR) within forty-nine days of the filing of an answer. RCFC 16(b)(1)(A); RCFC Appendix A § 4. The JPSR reflects the results of an early meeting of counsel to discuss various issues and attempt to arrive at a schedule to propose to the court.

The Court of Federal Claims will normally schedule a preliminary status conference, either in person if counsel are local or, more often, over the telephone. These conferences are individually arranged for each case. Unlike larger district courts, the Court of Federal Claims does not normally hold status calls in which multiple cases are scheduled for brief status conferences at the same time. At a preliminary status

conference, the court will discuss proposed scheduling and attempt to resolve differences.

While the Court of Federal Claims does not have a uniform pretrial order governing the exchange of infringement and invalidity contentions, along with proposed constructions of claim terms, the parties will usually propose a schedule that calls for these exchanges and leads to a *Markman* hearing. Some judges have used a pretrial schedule based generally on the local rules of the Northern District of California. See § 2.1.3.2.

13.5 Discovery

Discovery issues in the Court of Federal Claims are similar to those in district court practice. See Chapter 4. Unlike district courts, however, the Court of Federal Claims judges do not have magistrate judges to handle discovery matters. Thus, judges directly resolve disputes based on their individual practices. A common approach is for one or both parties to request a telephonic status conference to raise a dispute. While this can ultimately require a motion to be filed, the judge can, where appropriate, forgo formal procedures and resolve the dispute informally. Some judges have invited the parties to call, particularly if a dispute arises during a deposition.

In § 1498 cases, the problem of asymmetric burdens can arise, since the government can have numerous agencies involved in a given case and voluminous (and possibly redundant) records. Similarly, e-discovery, particularly of e-mail, can pose a problem. In several cases, an e-discovery order has been entered along the lines of the Federal Circuit Advisory Council's model e-discovery order (contained in Appendix 4.2).

At the conclusion of discovery, the Court of Federal Claims will hold a post-discovery conference to determine how the case will proceed to resolution, either by trial or possibly by dispositive motions. RCFC Appendix A § 11. If the case will proceed to trial, Appendix A sets forth a series of steps to be taken, including the submission of pretrial findings of fact and conclusions of law. *Id.* §§ 13–17. The court may, and often does, call for the submission of posttrial briefs along with findings of fact that are annotated with citations to the record. *Id.* § 18.

Chapter 14

Patent Law Primer

- 14.1 The Patent 5
 - 14.1.1 The Patent Document 5
 - 14.1.1.1 The First Page—Administrative Details 7
 - 14.1.1.2 Drawings 7
 - 14.1.1.3 The Specification 7
 - 14.1.1.3.1 Claims 7
- 14.2 Patent Prosecution and the Patent Lifecycle 9
 - 14.2.1 Institutional Aspects 9
 - 14.2.1.1 The Patent Office 9
 - 14.2.1.2 The Patent Bar 10
 - 14.2.1.3 The Patent Trial and Appeal Board (PTAB) 10
 - 14.2.1.4 Laws Governing the USPTO and the Manual of Patent Examining Procedure (MPEP) 11
 - 14.2.2 Filing a Patent Application 11
 - 14.2.2.1 Overview of Patent Examination 11
 - 14.2.2.2 The Application 12
 - 14.2.2.2.1 Elements of a Nonprovisional Patent Application 12
 - 14.2.2.2.2 Disclosure of Prior Art 13
 - 14.2.2.2.2.1 Prior Art Disclosure by Applicant—Information Disclosure Statement 13
 - 14.2.2.2.2.2 Prior Art Disclosure by Third Parties—Preissuance Submissions 13
 - 14.2.2.2.3 Priority Date 13
 - 14.2.2.2.4 Nonstandard Applications 13
 - 14.2.2.3 Restriction Requirements and Divisional Applications 14
 - 14.2.2.4 Publication 14
 - 14.2.3 The Prosecution History or “File Wrapper” 15
 - 14.2.3.1 Office Actions 15
 - 14.2.3.1.1 Affidavits 15
 - 14.2.3.1.2 Interview Report 15
 - 14.2.3.2 Request for Continued Examination (RCE) 16
 - 14.2.3.3 Continuation Applications 16
 - 14.2.3.4 Continuation-in-Part (CIP) Applications 16
 - 14.2.3.5 PTO Petition and Appeals 17
 - 14.2.4 Patent Duration 17
 - 14.2.4.1 Patent-Term Adjustments 18
 - 14.2.4.2 Patent-Term Restoration 18
 - 14.2.5 Postissuance Corrections and Administrative Proceedings 18
 - 14.2.5.1 Disclaimers 18
 - 14.2.5.2 Certificate of Correction 19
 - 14.2.5.3 Supplemental Examination 19
 - 14.2.5.4 Reissue 20
 - 14.2.5.4.1 Narrowing Reissues 21
 - 14.2.5.4.2 Broadening Reissues 21
 - 14.2.5.4.2.1 The Recapture Rule 21
 - 14.2.5.4.2.2 Intervening Rights 22
 - 14.2.5.5 Reexamination 23
 - 14.2.5.5.1 The Reexamination Process 23
 - 14.2.5.5.2 Ex Parte Reexamination 24
 - 14.2.5.5.3 Inter Partes Reexamination 24
 - 14.2.5.5.4 Reexamination and Concurrent Litigation 24
 - 14.2.5.6 Inter Partes Review (IPR) 25
 - 14.2.5.7 Postgrant Review (PGR) 26

- 14.2.5.7.1 Covered Business-Method Review (CBMR) 26
- 14.2.5.7.2 Postgrant, Inter Partes, and Covered Business-Method Review and Concurrent Litigation 27
- 14.2.6 The Presumption of Validity 28
- 14.3 Validity 29
 - 14.3.1 Patentable Subject Matter (§ 101) 29
 - 14.3.1.1 Modern Core Principles: Ineligible Subject Matter and Inventive Application 30
 - 14.3.1.2 The Evolution of Patentable Subject-Matter Limitations 31
 - 14.3.1.2.1 Early Development of Patent-Eligibility Limitations 32
 - 14.3.1.2.2 *Funk Brothers* (1948): The Emergence of Inventive Application 34
 - 14.3.1.2.3 The New Technological Age 36
 - 14.3.1.2.4 The Rise of the Federal Circuit and Dismantling of Patentable Subject-Matter Limitations 40
 - 14.3.1.2.5 The Supreme Court’s Revival of Subject-Matter Limitations 41
 - 14.3.1.3 Patent-Eligibility Conundrums 44
 - 14.3.1.4 Subject Matter Expressly Excluded by Statute 45
 - 14.3.1.4.1 Tax Strategies 45
 - 14.3.1.4.2 Human Organisms 45
 - 14.3.2 Utility (§ 101) 45
 - 14.3.3 Disclosure (§ 112) 46
 - 14.3.3.1 Written Description 47
 - 14.3.3.1.1 Policing Continuation Practice 47
 - 14.3.3.1.2 Biotechnology Patents 48
 - 14.3.3.2 Enablement 48
 - 14.3.3.3 Best Mode 50
 - 14.3.3.4 Claim Definiteness 50
 - 14.3.4 Novelty and Statutory Bars (§ 102) 51
 - 14.3.4.1 The First-to-Invent Regime 51
 - 14.3.4.1.1 First to Invent—§ 102(a) 52
 - 14.3.4.1.1.1 “Known or Used” 53
 - 14.3.4.1.1.2 Printed Publication 53
 - 14.3.4.1.2 Novelty—First to Invent—§ 102(g) 54
 - 14.3.4.1.2.1 Conception 55
 - 14.3.4.1.2.2 Reduction to Practice 55
 - 14.3.4.1.2.3 Reasonable Diligence 56
 - 14.3.4.1.2.4 Abandoned, Suppressed, or Concealed 56
 - 14.3.4.1.2.5 Section 102(g)—Summary 56
 - 14.3.4.1.3 Novelty—“Secret Prior Art”—§ 102(e) 57
 - 14.3.4.1.4 Novelty—Derivation—§ 102(f) 57
 - 14.3.4.1.5 Statutory Bars—Timely Filing—§ 102(b) 57
 - 14.3.4.1.5.1 Experimental Use 58
 - 14.3.4.1.5.2 On Sale Bar 58
 - 14.3.4.1.6 Statutory Bars—Abandonment—§ 102(c) 60
 - 14.3.4.1.7 Statutory Bars—International Filing—§ 102(d) 60
 - 14.3.4.2 The First-to-File Regime 60
 - 14.3.4.2.1 Novelty and Prior Art—§ 102(a) 60
 - 14.3.4.2.2 Novelty—Grace Period and Exceptions to Prior Art—§ 102(b) 61
 - 14.3.4.2.3 Novelty—Joint Research—§ 102(c) 62
 - 14.3.4.2.4 Effective Date of Patent Prior Art—§ 102(d) 63
 - 14.3.4.2.5 Derivation Proceedings 63
 - 14.3.5 Nonobviousness—§ 103 63
 - 14.3.5.1 Historical Development 63
 - 14.3.5.2 Nonobviousness Standard 64
 - 14.3.5.2.1 Nonobviousness Under the First-to-Invent Regime 64

- 14.3.5.2.2 Nonobviousness Under the First-to-File Regime 65
- 14.3.5.3 Applying § 103 65
 - 14.3.5.3.1 Determining the Level of Ordinary Skill in the Art 65
 - 14.3.5.3.2 Scope and Content of the Prior Art 67
 - 14.3.5.3.3 Differences Between Invention and Prior Art 68
 - 14.3.5.3.4 Secondary Considerations 68
 - 14.3.5.3.4.1 Long-Felt Need and Failure by Others 69
 - 14.3.5.3.4.2 Awards and Praise 69
 - 14.3.5.3.4.3 Skepticism, “Teaching Away,” and Unexpected Results 69
 - 14.3.5.3.4.4 Licensing Activity 70
 - 14.3.5.3.4.5 Copying 70
 - 14.3.5.3.4.6 Commercial Success 70
 - 14.3.5.3.5 The Ultimate Conclusion and Combining References 70
- 14.3.6 Inventorship 75
 - 14.3.6.1 Inventive Entities 76
 - 14.3.6.2 Default Rights of Owners 76
 - 14.3.6.3 Correction of Inventorship 76
- 14.4 Enforcement: Infringement, Defenses, and Remedies 77
 - 14.4.1 Infringement 77
 - 14.4.1.1 Section 271 77
 - 14.4.1.2 Direct Infringement 77
 - 14.4.1.3 Indirect Infringement 77
 - 14.4.1.3.1 Inducement 78
 - 14.4.1.3.2 Contributory Infringement 79
 - 14.4.1.3.3 Joint Infringement 79
 - 14.4.1.4 Infringement Analysis 80
 - 14.4.1.4.1 Literal Infringement 80
 - 14.4.1.4.1.1 Interpreting the Literal Scope of Means-Plus-Function Claims (§ 112(f)) 80
 - 14.4.1.4.1.1.1 Determining Whether a Claim Limitation Is Governed by § 112(f) 81
 - 14.4.1.4.2 Nonliteral Infringement—The Doctrine of Equivalents 82
 - 14.4.1.4.2.1 Limiting Principles 82
 - 14.4.1.4.2.1.1 The All-Elements (All-Limitations) Rule 83
 - 14.4.1.4.2.1.1.1 Claim Vitiating 83
 - 14.4.1.4.2.1.1.2 Prosecution History Estoppel 83
 - 14.4.1.4.2.1.1.2.1 Specific Exclusion 85
 - 14.4.1.4.2.1.1.3 Prior Art Rule 85
 - 14.4.1.4.2.1.1.4 The Public Dedication Rule 86
 - 14.4.1.4.2.2 Interpreting the Nonliteral Scope of Means-Plus-Function Claims 86
 - 14.4.1.4.3 The Reverse Doctrine of Equivalents 87
 - 14.4.1.4.5 Extraterritorial Infringement 88
 - 14.4.1.5.1 Manufacturing Components Within the United States for Assembly Abroad—§ 271(f) 88
 - 14.4.1.5.2 Importing Products Made Using Patented Processes—§ 271(g) 89
 - 14.4.2 Defenses 89
 - 14.4.2.1 Noninfringement 89
 - 14.4.2.2 Absence of Liability 89
 - 14.4.2.2.1 Consent or License 89
 - 14.4.2.2.1.1 First Sale Doctrine/Exhaustion Principle 90
 - 14.4.2.2.1.2 Shop Right 91
 - 14.4.2.2.2 Experimental Use Defense 91
 - 14.4.2.2.3 Prior-Use Right 92
 - 14.4.2.2.4 Bar Against Remedies for Infringement of Medical Procedure Patents by Doctors and Hospitals 92
 - 14.4.2.2.5 Sovereign Immunity 93

- 14.4.2.3 Unenforceability 93
 - 14.4.2.3.1 Inequitable Conduct 93
 - 14.4.2.3.2 Patent Misuse 94
 - 14.4.2.3.2.1 Postexpiration Royalties 95
 - 14.4.2.3.3 Equitable Estoppel 95
 - 14.4.2.3.4 Laches 96
 - 14.4.2.3.4.1 Prosecution Laches 96
- 14.4.2.4 Invalidity 97
 - 14.4.2.4.1 Double Patenting 97
 - 14.4.2.4.1.1 Statutory, or Same-Invention 97
 - 14.4.2.4.1.2 Nonstatutory, or Obviousness-Type 98
 - 14.4.2.4.2 Estoppel by Transfer of Ownership 98
 - 14.4.2.4.2.1 Assignor Estoppel 98
 - 14.4.2.4.2.2 No Licensee Estoppel 99
 - 14.4.2.4.2.3 Assignee Estoppel 100
- 14.4.2.5 Antitrust Counterclaims 100
- 14.4.3 Remedies 101
 - 14.4.3.1 Injunctive Relief 101
 - 14.4.3.1.1 Preliminary Injunction 101
 - 14.4.3.1.2 Permanent Injunction 102
 - 14.4.3.2 Damages 103
 - 14.4.3.2.1 Compensatory Damages 103
 - 14.4.3.2.1.1 Lost Profits 103
 - 14.4.3.2.1.2 Convoys Sales 104
 - 14.4.3.2.1.3 Price Erosion 104
 - 14.4.3.2.1.4 Reasonable Royalty 104
 - 14.4.3.2.1.4.1 Damages Theories 106
 - 14.4.3.2.1.4.2 FRAND Licensing of Standard Essential Patents 109
 - 14.4.3.2.1.5 Marking 110
 - 14.4.3.2.2 Enhanced Damages 111
 - 14.4.3.2.3 Prejudgment Interest 111
 - 14.4.3.3 Costs 112
 - 14.4.3.4 Attorneys' Fees 112
- 14.5 Other Patent-Related Causes of Action 113
 - 14.5.1 False Marking 113
 - 14.5.2 Civil Actions Under §§ 145 and 146 113
- 14.6 Appeals and Parallel Litigation 114
 - 14.6.1 Appeals to the Federal Circuit 114
 - 14.6.1.1 Appellate Jurisdiction 114
 - 14.6.1.2 Choice of Law 114
 - 14.6.1.3 Interlocutory Appeals 116
 - 14.6.2 Parallel Litigation Forums 116
 - 14.6.2.1 International Trade Commission 116
 - 14.6.2.2 Patent Office Reexamination or Review 117
 - 14.6.2.3 Other District Courts and MDL Proceedings 117
 - 14.6.2.4 Foreign Courts 117

This chapter surveys the procedures for obtaining patents and the substantive law governing patent litigation. It also provides an overview of the patent system and a starting point for researching patent law. After reviewing an actual patent document, the chapter summarizes prosecution, the process through which the U.S. Patent and Trademark Office (USPTO) grants patents to inventors. Patent cases often require courts to examine the prosecution history that led to the issuance of a patent.

The prosecution section provides a window into the USPTO to provide an appreciation of how patents are examined. The chapter then reviews the law regarding patent validity. The right to exclude others from practicing an invention is available only if several requirements are met. The chapter then discusses patent enforcement: infringement of a patent claim, defenses to a charge of infringement, and remedies. The chapter concludes by examining the wider battlefield for patent litigation existing outside of the district court—the appellate process and proceedings before the International Trade Commission, the USPTO, other U.S. courts, and foreign courts. Appendix A provides a glossary of patent law terms. Appendix B lists common acronyms.

14.1 The Patent

A patent grants its owner the right to exclude others from making, using, selling, offering to sell, importing, or offering to import the claimed invention within or into the United States. § 271.¹ Because a patent provides only a right to exclude, a patentee does not have an affirmative right to practice the invention. Inventors sometimes cannot make their patented inventions without infringing other patents on underlying technology. Such blocking patents in turn spur substantial licensing activity. As befits a right to exclude, a patent “ha[s] the attributes of personal property.” § 261.

Unlike copyrights or trade secrets, a patent must issue from the USPTO after a proper application has been made by the inventor. The requirements of patentability are set forth in Title 35 of the U.S. Code, reflecting the omnibus codification of patent law completed in 1952 as well as numerous subsequent amendments, the most substantial of which is the Leahy-Smith America Invents Act, Pub. L. No. 112-29, 125 Stat. 284 (2011) (AIA), enacted on September 16, 2011.

14.1.1 The Patent Document

Patents issued by the USPTO follow a common format dictated by the World Intellectual Property Organization (WIPO).

1. Unless otherwise indicated, all section references are to the Patent Act (35 U.S.C. (2012)).

Figure 14.1
Page One of a Standard Patent Application

 US005205473A

United States Patent [19] [11] **Patent Number:** **5,205,473**
Coffin, Sr. [45] **Date of Patent:** **Apr. 27, 1993**

<p>[54] RECYCLABLE CORRUGATED BEVERAGE CONTAINER AND HOLDER</p> <p>[75] Inventor: David W. Coffin, Sr., Fayetteville, N.Y.</p> <p>[73] Assignee: Design By Us Company, Philadelphia, Pa.</p> <p>[21] Appl. No.: 854,425</p> <p>[22] Filed: Mar. 19, 1992</p> <p>[51] Int. Cl.⁵ B65D 3/28</p> <p>[52] U.S. Cl. 229/1.5 B; 206/813; 220/441; 220/DIG. 30; 229/1.5 H; 229/DIG. 2; 493/296; 493/907</p> <p>[58] Field of Search 229/1.5 B, 1.5 H, 4.5, 229/DIG. 2; 220/441, 671, 737-739, DIG. 30; 493/287, 296, 907, 908; 209/8, 47, 215; 206/813</p> <p>[56] References Cited</p> <p style="margin-left: 20px;">U.S. PATENT DOCUMENTS</p> <table border="0" style="margin-left: 20px; font-size: small;"> <tr><td>1,732,322</td><td>10/1929</td><td>Wilson et al.</td><td>.....</td><td>220/DIG. 30</td></tr> <tr><td>1,771,765</td><td>7/1930</td><td>Benson</td><td>.....</td><td>229/4.5</td></tr> <tr><td>2,266,828</td><td>12/1941</td><td>Sykes</td><td>.....</td><td>229/1.5 B</td></tr> <tr><td>2,300,473</td><td>11/1942</td><td>Winkle</td><td>.....</td><td>229/4.5</td></tr> <tr><td>2,501,815</td><td>3/1950</td><td>Hamm</td><td>.....</td><td></td></tr> <tr><td>2,617,549</td><td>11/1952</td><td>Egger</td><td>.....</td><td></td></tr> <tr><td>2,641,402</td><td>6/1953</td><td>Bruun</td><td>.....</td><td>229/4.5</td></tr> </table>	1,732,322	10/1929	Wilson et al.	220/DIG. 30	1,771,765	7/1930	Benson	229/4.5	2,266,828	12/1941	Sykes	229/1.5 B	2,300,473	11/1942	Winkle	229/4.5	2,501,815	3/1950	Hamm		2,617,549	11/1952	Egger		2,641,402	6/1953	Bruun	229/4.5	<table border="0"> <tr><td>2,661,889</td><td>12/1953</td><td>Phinney</td><td>.....</td><td>229/4.5</td></tr> <tr><td>2,969,901</td><td>1/1961</td><td>Behrens</td><td>.....</td><td>229/1.5 B</td></tr> <tr><td>3,237,834</td><td>3/1966</td><td>Davis et al.</td><td>.....</td><td>229/1.5 B</td></tr> <tr><td>3,779,157</td><td>12/1973</td><td>Ross, Jr. et al.</td><td>.....</td><td>53/527</td></tr> <tr><td>3,785,254</td><td>1/1974</td><td>Mann</td><td>.....</td><td></td></tr> <tr><td>3,890,762</td><td>6/1975</td><td>Ernst et al.</td><td>.....</td><td></td></tr> <tr><td>3,908,523</td><td>9/1975</td><td>Shikaya</td><td>.....</td><td>229/1.5 B</td></tr> <tr><td>4,080,880</td><td>3/1978</td><td>Shikay</td><td>.....</td><td>493/296</td></tr> <tr><td>4,146,660</td><td>3/1979</td><td>Hall et al.</td><td>.....</td><td></td></tr> <tr><td>4,176,054</td><td>11/1979</td><td>Kelley</td><td>.....</td><td>209/8</td></tr> <tr><td>5,009,326</td><td>4/1991</td><td>Reaves et al.</td><td>.....</td><td></td></tr> <tr><td>5,092,485</td><td>3/1992</td><td>Lee</td><td>.....</td><td>229/1.5 B</td></tr> </table> <p style="text-align: center;">OTHER PUBLICATIONS</p> <p>"The Wiley Encyclopedia of Packaging Technology", John Wiley & Sons, pp. 66-69, 1986.</p> <p><i>Primary Examiner</i>—Gary E. Elkins <i>Attorney, Agent, or Firm</i>—Synnestvedt & Lechner</p> <p>[57] ABSTRACT</p> <p>Corrugated beverage containers and holders are which employ recyclable materials, but provide fluting structures for containing insulating air. These products are easy to hold and have a lesser impact on the environment than polystyrene containers.</p> <p style="text-align: center;">18 Claims, 8 Drawing Sheets</p>	2,661,889	12/1953	Phinney	229/4.5	2,969,901	1/1961	Behrens	229/1.5 B	3,237,834	3/1966	Davis et al.	229/1.5 B	3,779,157	12/1973	Ross, Jr. et al.	53/527	3,785,254	1/1974	Mann		3,890,762	6/1975	Ernst et al.		3,908,523	9/1975	Shikaya	229/1.5 B	4,080,880	3/1978	Shikay	493/296	4,146,660	3/1979	Hall et al.		4,176,054	11/1979	Kelley	209/8	5,009,326	4/1991	Reaves et al.		5,092,485	3/1992	Lee	229/1.5 B
1,732,322	10/1929	Wilson et al.	220/DIG. 30																																																																																												
1,771,765	7/1930	Benson	229/4.5																																																																																												
2,266,828	12/1941	Sykes	229/1.5 B																																																																																												
2,300,473	11/1942	Winkle	229/4.5																																																																																												
2,501,815	3/1950	Hamm																																																																																													
2,617,549	11/1952	Egger																																																																																													
2,641,402	6/1953	Bruun	229/4.5																																																																																												
2,661,889	12/1953	Phinney	229/4.5																																																																																												
2,969,901	1/1961	Behrens	229/1.5 B																																																																																												
3,237,834	3/1966	Davis et al.	229/1.5 B																																																																																												
3,779,157	12/1973	Ross, Jr. et al.	53/527																																																																																												
3,785,254	1/1974	Mann																																																																																													
3,890,762	6/1975	Ernst et al.																																																																																													
3,908,523	9/1975	Shikaya	229/1.5 B																																																																																												
4,080,880	3/1978	Shikay	493/296																																																																																												
4,146,660	3/1979	Hall et al.																																																																																													
4,176,054	11/1979	Kelley	209/8																																																																																												
5,009,326	4/1991	Reaves et al.																																																																																													
5,092,485	3/1992	Lee	229/1.5 B																																																																																												

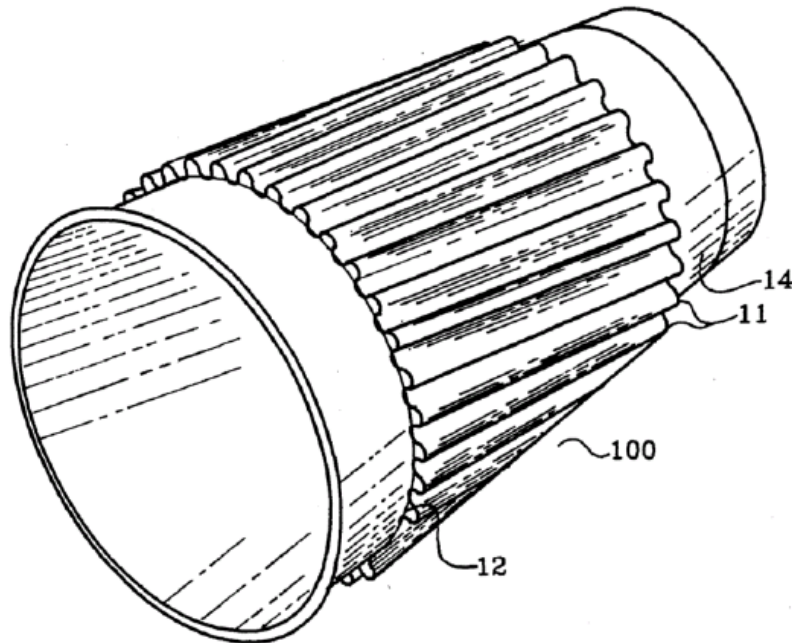

14.1.1.1 The First Page—Administrative Details

As reflected in Figure 14.1, the first page of a U.S. patent contains a header, an abstract, and a representative drawing. The header contains bibliographic information categorized using the Internationally (agreed) Numbers for the Identification of (bibliographic) Data (INID) classification system. Field 19 (labeled [19]) indicates the office or organization publishing the document, here the U.S. Patent Office. Field 11 shows the patent number. Every patent has a unique number assigned by the Patent Office in the order they issue. Parties often abbreviate patents to their last three numbers for convenience. Thus, Patent No. 5,205,473 becomes “the ’473 patent.” Field 45 contains the date the patent issued.

Fields 50–58 provide technical information, such as the domestic classification ([52]), title ([54]), a list of prior art documents cited during prosecution by the examiner or by the applicant ([56]), the abstract ([57]), and the technical field of search ([58]). The header also contains information showing the history and ownership of the patent. Fields 60–68 provide references to other legally or procedurally related domestic patent documents. (The ’473 patent does not have any such references.) Fields 70–76 reveal the names of the inventors, assignees, and attorney or agents.

14.1.1.2 Drawings

Immediately following the first page are the drawings (if any), which illustrate the claimed invention. The drawings are routinely labeled with numbers to facilitate describing the invention and its components in the patent’s specification.

14.1.1.3 The Specification

The specification describes the claimed invention. Section 112 lists a number of formal requirements that the specification must meet for a patent claim to be valid. See § 14.3.3. The specification begins by repeating the title of the invention, then listing any related patent applications. The specification typically proceeds by explaining the “field of the invention,” another general description of the kind of invention the patent discloses. The “background of the invention” discusses the prior art in the field and the problems the prior art could not address. The “summary of the invention” briefly describes what the patentee has accomplished in the claimed invention. A “brief description of the drawings” commonly follows.

The “detailed description of the invention” is the heart of the specification and the “consideration” the public receives in exchange for the patent grant. It seeks to describe the invention in such detail that a person having ordinary skill in the art could practice the invention. It often explains the invention by explaining the drawings. All specifications must also disclose the “preferred embodiments” and “best mode” for practicing the invention.

14.1.1.3.1 Claims

The specification concludes with claims. The claims are commonly analogized to the “metes and bounds” of a property deed and serve the same purpose: to delineate

the scope of the asset which, in the patent context, is an invention. Each claim represents the legal right to exclude others from making, using, selling, offering to sell, importing, or offering to import the claimed process, machine, manufacture, or composition of matter. A patent may, and often does, contain many claims, which usually become increasingly specific.

An “independent claim” stands on its own. A “dependent claim” refers to a single earlier claim or claims and adds further limitations. To understand all of the limitations of a dependent claim, it is necessary to read that claim together with the claim(s) on which it depends.

In a case for patent infringement, only some claims may be asserted. Some might not be infringed; further, some may even be invalid. It is important to recognize that each claim bestows distinct legal rights. Invalidity or noninfringement of one or more claims will not necessarily undermine other claims in the same patent.

Patent claims have a unique structure. Each claim must be stated as a single sentence. They begin with a preamble, which briefly describes the nature of the claimed invention. For example, a claim for a paper clip could begin, “A device for keeping papers together” In some circumstances, the preamble can act as an additional limitation on the scope of the claimed invention. *See* § 5.2.3.2.5.

The claim then has a transitional phrase, which demarcates the preamble from the list of restrictions or limitations that define the claimed invention. Patents often feature the same transitions, which have developed highly specific meanings in the case law. The transition “comprising” is understood to mean “including but not limited to”—that is, that the claim covers the listed limitations, as well as anything that includes all of the limitations and additional features. The transition “consisting of” means that the claim covers only the combination of the limitations listed and does not cover something that incorporates additional material along with all of the listed restrictions. The transition “consisting essentially of” covers not only products containing the recited limitations, but also those combining modest amounts of additional, unspecified substances, the presence of which would not materially affect the basic and novel properties of the expressly recited ingredients.

After the transition, the claim has a body that lists the limitations or restrictions of the claimed invention. Patentees typically use a method of peripheral claiming to delineate the outer boundaries of the claimed invention. Thus, the claim limitations or restrictions define what remains in the claim. The claim’s body lists all of the features that must be present in the claimed invention and how these restrictions interact with each other.

As an illustration, consider a patent claim for a coffee cup insulator covered by the ’473 patent illustrated in Table 14.1.

Table 14.1
Illustration of a Patent Claim

Preamble	A recyclable, insulating beverage container holder,
Transition	comprising
Body	a corrugated tubular member comprising cellulosic material and at least a first opening therein for receiving and retaining a beverage container, said corrugated tubular member comprising fluting means for containing insulating air; said fluting means comprising fluting adhesively attached to a liner with a recyclable adhesive.

Some claims contain words or structures, which, like the transitions, have specific, well-understood meanings. A means-plus-function claim defines one or more elements of the claim as a “means for [performing a] function,” as allowed by § 112(f). This special type of claim format is interpreted based on how the structure, materials, or acts are described in the specification and to encompass “equivalents thereof” as of the time of filing. *See* §§ 5.2.3.5; 14.4.1.4.1.1.

Claims can follow other formats. As noted above, a dependent claim refers to one or several prior claim(s) and adds further limitations. A Jepson claim recites the elements of the prior art, then the transition “the improvement of which comprises,” followed by the further restrictions that represent the advance over the prior art. A Markush claim covers a genus of related compositions sharing a common trait, such as “a chemical compound of the formula COOH-CH₂-R, where R is selected from the group consisting of R₁, R₂, and R₃.” Markush claims arise principally in the field of chemistry.

Interpreting the scope of claims is one of the principal challenges of patent litigation. The substantive law regarding how to interpret claim terms is presented in Chapter 5.

14.2 Patent Prosecution and the Patent Lifecycle

14.2.1 Institutional Aspects

14.2.1.1 The Patent Office

The USPTO is a federal agency in the Department of Commerce responsible for administering the patent and trademark laws. The USPTO’s primary function is to examine inventors’ applications and to determine whether to issue a patent. The USPTO also promulgates rules regarding the examination process and records all transfers of patent rights, in similar fashion to a state recordation office under Article 9 of the Uniform Commercial Code.

The USPTO employs over 7,000 scientists and engineers to examine patent applications. Examiners possess a science or engineering degree and are divided by Technology Centers (or group art units). A patent examiner need not hold a law degree, and the majority of patent examiners do not. The USPTO does, however, pro-

vide all examiners with training in patent law and procedure. New examiners also serve an apprenticeship period working with an experienced examiner.

The USPTO maintains an extensive website at <http://www.uspto.gov/>, which provides resources regarding the patent examination process and a searchable database of patents.

14.2.1.2 The Patent Bar

The USPTO requires practitioners who prepare and prosecute patent applications on behalf of others to pass a patent bar exam. To sit for the patent bar, applicants must possess scientific or technical training. One does not need to hold a law degree. Nonattorney members of the patent bar are called patent agents. Collectively, practitioners before the USPTO are known as patent prosecutors. The distinction between an inventor's prosecution counsel and trial counsel is critical to protective orders and the scope of attorney-client privilege. *See* §§ 4.2.5, 4.6.7–9.

Most litigated patents will have been drafted and prosecuted by a professional. Nonetheless, the USPTO does allow inventors to pursue their own application even if they have not passed the patent bar.

14.2.1.3 The Patent Trial and Appeal Board (PTAB)

The PTAB comprises the USPTO director, the deputy director, the commissioner for patents, the commissioner for trademarks, and administrative patent judges. Pursuant to the AIA § 7, the PTAB replaced the Board of Patent Appeals and Interferences (BPAI) as of September 16, 2012.² In addition to handling appeals from examiner rejections, the PTAB conducts several new administrative proceedings introduced under the AIA: postgrant review, covered business-method (CBM) review, inter partes review (IPR), and derivation proceedings. The PTAB also handles any interferences³ or appeals of inter partes reexaminations that were filed before they were phased out under the AIA. Applicants may appeal decisions of the PTAB to the Federal Circuit.

The PTAB is often one of the first bodies to respond to changes in the substantive law of patent validity. For example, the PTAB was at the forefront of interpreting the Supreme Court's *KSR* opinion regarding obviousness. *KSR Int'l Co. v. Teleflex Inc.*, 550 U.S. 398 (2007). Despite the PTAB's familiarity with patent law, district courts owe its decisions no formal deference. Only the Federal Circuit creates binding precedent for the district courts when adjudicating patent cases. Nevertheless, the PTAB is an experienced and specialized agency tribunal such that a district court may find its rulings persuasive.

2. For the sake of consistency, this guide will use the acronym PTAB even when referring to the BPAI's decisions or actions before September 16, 2012.

3. An "interference proceeding" is an adversarial administrative adjudication that determines which of two or more inventors seeking a patent on the same invention has priority. *See* § 135. Any party to an interference proceeding that is dissatisfied with the PTAB decision can pursue a remedy in a district court. *See* § 146.

14.2.1.4 Laws Governing the USPTO and the Manual of Patent Examining Procedure (MPEP)

The patent statute is found in Title 35 of the U.S. Code. The USPTO's rules and regulations implementing the patent laws are codified in Title 37 of the Code of Federal Regulations.

The Manual of Patent Examining Procedure (MPEP) is the USPTO's operating manual for patent examiners. See <http://www.uspto.gov/web/offices/pac/mpep/index.htm>. Because most USPTO examiners are not attorneys, patent prosecutors will often cite the MPEP rather than case law during the course of patent prosecution. However, the MPEP does not carry the force of law.

Where the substantive patent law is uncertain, the USPTO issues guidelines to help examiners apply the law consistently. For example, there are guidelines governing the subject-matter requirement (MPEP § 2106), utility requirement (MPEP § 2107), and written description requirement (MPEP § 2163). Such guidelines represent the USPTO's interpretation of the law in those areas, but they are not substantive rulemaking and do not have the force and effect of law. While such guidelines may be persuasive on an issue, a district court is free to reach its own interpretation. Courts must, however, defer to USPTO interpretations of its procedures to the extent they are permissible under the governing statute. See *Cooper Techs. Co. v. Dudas*, 536 F.3d 1330, 1335–37 (Fed. Cir. 2008) (citing *Chevron U.S.A., Inc. v. Nat. Res. Def. Council, Inc.*, 467 U.S. 837 (1984)).

14.2.2 Filing a Patent Application

The process of patent procurement is commonly referred to as patent prosecution. Prosecution often consists of a lengthy and detailed interaction between the applicant and the USPTO examiner. During this process, the applicant attempts to convince the examiner that the applicant's invention meets the statutory requirements for patentability.

14.2.2.1 Overview of Patent Examination

Patent prosecution begins with an inventor having an idea that she believes is patentable. Although inventors may represent themselves before the USPTO, most retain a patent attorney or agent to prepare and prosecute their application. The application contains a description of the invention and claims outlining the bounds of the intellectual property right sought by the inventor. The prosecutor must also submit an Information Disclosure Statement (IDS) listing all prior art material to patentability of which the inventor or any person associated with prosecution is aware.

The USPTO assigns the application to an examiner in the most pertinent Technology Center. In addition to confirming that all formalities have been complied with, the examiner conducts a prior art search and assesses whether the proposed claims meet the requirements for patentability (§§ 101, 102, 103, and 112).

The first Office action almost always rejects the patent application. The examiner cites the relevant patent law authority and succinctly explains the reasons for rejection. At this point, the examiner bears the burden of establishing a prima facie case of unpatentability. The applicant then has the opportunity to respond to the Office action. *See* 37 C.F.R. § 1.111. Arguments made to overcome the examiner's rejections are commonly referred to as "traversing" the rejections. The applicant may argue that the examiner has mischaracterized the specification or the prior art and that the application, or portions thereof, should be allowed as submitted. In the alternative, the applicant may amend the claims.

The examiner may accept the applicant's amendments or arguments and allow the application in whole, or allow only some claims. If the applicant is unable to traverse, the examiner issues a so-called final rejection. In practice, the rejection is rarely the end of prosecution, which will generally continue until the applicant chooses to abandon the application or the examiner grants the claims. It is common for applicants to "continue" examination of the application, as discussed below. Alternatively, the applicant can appeal the examiner's rejection to the PTAB, and further still to the Federal Circuit.

Patent prosecution is an *ex parte* proceeding—only the applicant and the USPTO are directly involved. The examiner's actions play a significant role in shaping the contours of many patents. Patent prosecution operates much like a negotiation between the applicant and the USPTO.

The average prosecution pendency is three years, although it is not uncommon for prosecution to last five years or longer. The length of time required to prosecute the patent depends on any number of resource, strategic, and other factors and does not correlate with the "strength" of the patent claims.

Under the AIA, applicants may seek prioritized examination starting September 26, 2011 upon payment of an additional fee. AIA § 11. For applications considered important to the national economy or national competitiveness, the USPTO may prioritize examination at no extra cost to the applicant. AIA § 25.

14.2.2.2 The Application

Most applicants choose to file a nonprovisional patent application. Nonprovisional applications are the "regular" type of patent applications and are often referred to as "applications." Alternatively, applicants may file a provisional or Patent Cooperation Treaty (PCT) patent application prior to submission of the nonprovisional application. These types of applications are described further below.

14.2.2.2.1 Elements of a Nonprovisional Patent Application

The general requirements for a nonprovisional patent application include: (1) a written specification, including one or more claims; (2) an oath or declaration that the named inventor or inventors are believed to be the original and first inventor or inventors of the claimed subject matter; (3) drawings as required to support the application; and (4) applicable fees (e.g., filing fee, search fee, examination fee, and application-size fee). *See* 37 C.F.R. § 1.51; § 111; *see also* MPEP § 601.

Under the AIA, if an uncooperative or unavailable inventor is under an obligation to assign the invention, the assignee (who is typically the inventor's employer) may file a substitute statement in lieu of an oath or declaration. This provision became effective September 16, 2012, and applies to all applications filed on or after that date. AIA § 4.

14.2.2.2.2 Disclosure of Prior Art

14.2.2.2.2.1 Prior Art Disclosure by Applicant— Information Disclosure Statement

Applicants present prior art to the USPTO using an Information Disclosure Statement. *See* 37 C.F.R. § 1.97. The inventor and those assisting the inventor with the application process are not required to perform an exhaustive search of the prior art, but they must disclose all pertinent information of which they are aware. *See* 37 C.F.R. § 1.56. This requirement is part of the applicants' general duty of candor and good faith in dealing with the USPTO, which exists for the duration of patent prosecution. The USPTO will not issue a patent when faced with either fraudulent conduct or a failure to disclose material information through bad faith or intentional misconduct. *See id.* Such "inequitable conduct" can also render an issued patent unenforceable in later litigation. In some cases, applicants requesting accelerated examination must perform a preexamination search of the prior art and submit the results to the USPTO.

14.2.2.2.2.2 Prior Art Disclosure by Third Parties— Preissuance Submissions

The AIA provides a window during examination for third parties to submit prior art, along with a concise statement of relevance for each submitted document. These preissuance submissions became available September 16, 2012, for any applications pending on or filed after that date. AIA § 8.

14.2.2.2.3 Priority Date

The first filing of a patent application anywhere in the world describing an enabled invention usually establishes the "priority date" for that invention. The definition of prior art, which varies by country, is often keyed to the priority date. Some U.S. applications claim "foreign priority," which means that their priority date is derived from an earlier-filed foreign application.

With the enactment of the AIA, priority dates are treated differently for prior art purposes depending on whether the application was filed prior to March 16, 2013, under the first-to-invent regime, or on or after that date when the first-to-file rules govern. *See* § 14.3.4.

14.2.2.2.4 Nonstandard Applications

A patent application can also mature from several other types of filings. The most important is the provisional application. The USPTO began accepting provi-

sional patent applications on June 8, 1995. *See* § 111(b). Provisional applications must contain a specification and required drawings, but need not contain claims or an oath or declaration. Provisional applications are less expensive to prepare and file than a nonprovisional application and preserve a priority filing date for a later filed nonprovisional application. Provisional applications are not examined by the USPTO and are subject to abandonment after twelve months.

An applicant can also file an application under the Patent Cooperation Treaty (PCT) to establish a priority date to an invention. Under the PCT, applicants can file a single application in a qualified patent office to initiate prosecution in all signatory countries. Over 130 nations have signed the PCT.

Finally, inventors can claim priority for U.S. patent applications based on filings in certain foreign countries, including any World Trade Organization (WTO) member state. *See* § 119. The applicant has twelve months from the time of the foreign filing to submit a U.S. national application claiming the same invention.

14.2.2.3 Restriction Requirements and Divisional Applications

If a nonprovisional application claims multiple independent and unique inventions, the examiner may “restrict” the application. *See* 37 C.F.R. § 1.142. Restriction requires the applicant to elect which invention it intends to pursue in the pending application. The other inventions can be examined in separate “divisional” applications that maintain the priority date of the original application. The examiner can also require a restriction if a reply to an office action introduces claims that are distinct from and independent of the invention previously claimed. *See* 37 C.F.R. § 1.145. The applicant can attempt to overcome the restriction requirement on the grounds that the examiner can assess all claims without performing an extra prior art search (*see* 37 C.F.R. § 1.143), but such arguments are typically unsuccessful. However, the examiner can also rejoin restricted claims upon allowance. Restriction is a procedural matter: a patent’s validity does not depend on whether it claims multiple inventions. Restriction and division practice does, however, explain the typical manner in which one specification and written description can spawn a family of patents.

14.2.2.4 Publication

Until 2000, pending U.S. patent applications were held in secret by the USPTO until issuance. Under this system, patent applicants could draw out prosecution in secret for many years. Such “submarine” patents could emerge out of nowhere many years or even decades after filing, resulting in unfair surprise to others who began using the claimed invention during the secret pendency. Furthermore, if the patent did not issue or the inventor believed trade secrecy to be more advantageous than patenting, the applicant could abandon the application and maintain the invention as a trade secret.

The American Inventors Protection Act of 1999 brought the U.S. into harmony with most foreign patent offices by requiring the USPTO to publish nonprovisional patent applications eighteen months after their filing date. Published applications are available at the USPTO’s website. *See* <http://www.uspto.gov/patft/index.html>. An

applicant can opt out of publication only by certifying that the applicant has not and will not file any foreign applications on the same invention. Thus, applicants can maintain patent applications being pursued solely in the United States as trade secrets until issuance.

14.2.3 The Prosecution History or “File Wrapper”

The archive of written communications between the USPTO and the applicant during patent prosecution is called the “prosecution history” or “file wrapper.” The file wrapper is available through the USPTO’s Patent Application Information Retrieval (PAIR) system, *available at* <http://portal.uspto.gov/external/portal/pair>. This “procedural history” is important because, in addition to the patent’s specification, correspondence between the patentee and the USPTO during prosecution is a primary source used to interpret claim language during litigation. *See Phillips v. AWH Corp.*, 415 F.3d 1303 (Fed. Cir. 2005) (en banc); § 5.2.2.1.1. Furthermore, the patentee is estopped from recovering through reexamination or during litigation (under the doctrine of equivalents) any subject matter surrendered during prosecution. The following sections explain the file wrapper’s contents.

14.2.3.1 Office Actions

The patent examiner’s responses are known as “office actions.” These statements document the examiner’s decisions and underlying reasons. The applicant can respond to the examiner’s rejection arguments. This record of office actions and responses determines if and to what extent a patentee narrowed the scope of his or her claimed invention to overcome a rejection. It also bears on whether the patentee engaged in inequitable conduct. *See* § 14.4.2.3.1.

14.2.3.1.1 Affidavits

The applicant may attempt to overcome certain rejections through the use of affidavits. Rule 131 affidavits are used to establish inventorship before the date of prior art arising under § 102(a), (e), or (g). *See* 37 C.F.R. § 1.131. This process is known as “swearing behind” the prior art reference. Rule 131 requires an oath or declaration by the inventor along with supporting evidence. Misrepresentations in Rule 131 affidavits may violate the applicant’s duty of good faith and candor, rendering the patent unenforceable. For patent applications subject to the first-to-file regime established under the AIA, “swearing behind” is not possible. *See* § 14.3.4.2.1.

Rule 132 affidavits contain information seeking to traverse rejections. *See* 37 C.F.R. § 1.132. These are commonly used to submit expert testimony responding to an obviousness rejection.

14.2.3.1.2 Interview Report

Applicants may request a telephone or face-to-face interview with the examiner. *See* 37 C.F.R. § 1.133. The applicant may be required to submit a written report of the meeting, although the report can be general. Many practitioners rely on inter-

views to expedite prosecution by personally engaging the examiner. Some practitioners also use interviews to limit the amount of written correspondence entering the prosecution history.

14.2.3.2 Request for Continued Examination (RCE)

Applicants generally have one opportunity to traverse the examiner's rejections before receiving a final rejection. After receiving a final rejection, applicants will often file a RCE in order to submit further arguments, claim amendments, or Information Disclosure Statements. *See* 37 C.F.R. § 1.114. An RCE provides applicants with another round of examination in the same application; it is not uncommon to see patents issue from applications in which multiple RCEs were filed. Instead of filing an RCE, applicants can pursue the rejected claims in a continuation application, or they can appeal the examiner's decision to the PTAB.

14.2.3.3 Continuation Applications

A continuation application is a second application for an invention claimed in a prior application. To qualify as a continuation application and claim the benefits of the earlier "parent" application's priority date, the application must be filed while the parent is still pending (i.e., not issued or abandoned), expressly refer to the parent application, identify at least one common inventor, and encompass the same disclosure of the parent application without adding any new matter. *See* § 120. The same invention must be claimed, but the scope of the claims can vary. However, the patent term of the continuation is limited to twenty years from the filing of the earliest application to which it claims priority.

Applicants often use continuation applications to pursue rejected claims or new claims that are different (usually broader) in scope from those in the parent application. A continuation application might also be used when the examiner allows some claims but rejects others: the applicant can cancel the rejected claims and pursue them in a continuation application, while allowing the remaining claims to issue as a patent.

14.2.3.4 Continuation-in-Part (CIP) Applications

A CIP is similar to a continuation application but introduces new subject matter to the parent application. For example, the inventor may add new data and descriptive material to support the claims. Alternatively, the inventor may have made improvements to the claimed invention and wish to add them in a CIP application. Claims to the new subject matter do not get the advantage of the priority date of the parent application. The relevant consideration is whether the claims are supported by the disclosure of the parent application under the test set forth in § 112. Claims that are so supported can rely on the parent application's priority date, whereas the other claims have the priority date of the CIP filing. Accordingly, some references might count as prior art for some of the claims in the CIP, but not qualify as prior art for other claims in the same application that are supported by the parent application's disclosure. Regardless of when material is added, all claims in a patent expire

on the same date—typically twenty years from the earliest parent application’s filing date. *See* § 14.2.4.

14.2.3.5 PTO Petition and Appeals

Applicants who reach an impasse with an examiner over procedural issues may petition the director of the USPTO. Such procedural issues include requests for time extensions, reviving abandoned applications, or reviewing a restriction requirement. Petitions are typically resolved in an informal manner by group directors in the USPTO.

An applicant may appeal a final rejection to the PTAB. *See* § 134. In upholding the rejection, the PTAB may consider any issue of patentability, including written description, enablement, novelty, and nonobviousness. The applicant may appeal adverse decisions of the PTAB to the Federal Circuit. *See* § 141. Alternately, the applicant may bring a civil action against the director to the U.S. District Court for the Eastern District of Virginia.⁴ *See* § 145; AIA § 9. The district court can overturn PTAB decisions and order the USPTO to issue a patent. The Federal Circuit also hears appeals from the district court. A civil suit may be more expensive than a direct appeal to the Federal Circuit, but has the advantage that new evidence can be submitted to the district court, whereas the Federal Circuit only considers the USPTO record.

14.2.4 Patent Duration

A patent whose application was filed on or after June 8, 1995, expires twenty years after the earliest effective U.S. filing date, *see* § 154(a)(2), unless subject to various extensions discussed below. Prior to this date, patents expired seventeen years from the issuance date. For patents that were granted or pending before June 8, 1995, the patent expires either twenty years after the date of filing or seventeen years from issuance, whichever is later. *See* § 154(c)(1). All claims in a CIP application expire based on the effective filing date of the parent application, regardless of whether a claim’s priority derives from the CIP application or its parent.

This change in the patent term harmonized the U.S. patent laws with those in most other nations. It also partially addressed the problem of “submarine patents.” Under the old law, a patentee could use continuation practice to keep a patent application pending for years (or sometimes decades) until an unsuspecting third party began practicing the claimed invention. The patentee could then get the submarine patent issued and sue for infringement. The current law alleviates this abuse by tying patent duration to the filing date, thereby imposing the costs of delayed prosecution upon the applicant. In addition, the doctrine of prosecution laches can be raised as a defense in cases of undue prosecution delay. *See* § 14.4.2.3.4.1.

4. Prior to September 16, 2011, applicants were able to appeal a PTAB decision to the U.S. District Court for the District of Columbia.

The actual patent term commences the date that the patent issues. Thus, the effective term of the patent will be less than twenty years due to the pendency of prosecution. Nonetheless, provisional rights allow a patentee to collect a reasonable royalty from an infringer who had actual knowledge of a published patent application back to the date of actual notice. *See* § 154(d); § 14.4.3.2.

14.2.4.1 Patent-Term Adjustments

A patent's duration can be extended to account for certain delays occurring during prosecution. *See* § 154(b). Section 154(b)(1)(A) compensates the patentee for undue delays in prosecution: if the USPTO fails to deliver the first office action within fourteen months of the filing date or if the examiner fails to respond to an office action reply within four months, then additional time will be tacked on the patent term. Similarly, § 154(b)(1)(B) extends the patent term if patent prosecution lasts more than three years, not including continuations, interferences, and appeals. Section 154(b)(1)(C) extends the patent term if a patentee successfully overcomes adverse rulings at interference or appeals proceedings, or if the patent was subject to a secrecy order. Patent term adjustments are, however, limited by delays caused by the patentee. *See* § 154(b)(2).

14.2.4.2 Patent-Term Restoration

A patent's term can be extended by statutory patent-term restorations. For example, the Drug Price Competition and Patent Term Restoration Act of 1984, more commonly known as the Hatch-Waxman Act, extends the patent term for drug-related inventions up to five years when the commercial use of the claimed invention was delayed by regulatory approval. *See* § 156.

14.2.5 Postissuance Corrections and Administrative Proceedings

The failure of the patentee, or in some cases the USPTO, to properly address errors in an issued patent can result in adverse consequences at trial, such as the inability to receive damages or even complete loss of patent rights. Several administrative options exist at the USPTO for patentees to correct errors in the patent document after the patent has issued, as well as for third parties to challenge the validity of issued patents: disclaimer, certificate of correction, supplemental examination, post-grant review, covered business-method review (CBMR), reissue, reexamination, and inter partes review (IPR).

14.2.5.1 Disclaimers

Under § 253, a patentee (without deceptive intent) may disclaim any complete patent claim by filing a request with the USPTO. A patentee may also disclaim or dedicate to the public the entire patent term or any remaining portion of the patent term. The latter process is called a "terminal disclaimer." This process is frequently used when the USPTO rejects a patent application as obvious over an earlier patent

or application by the same person. By filing the terminal disclaimer, the applicant agrees that the later filed application will expire at the same time as the prior patent (or application).

14.2.5.2 Certificate of Correction

Minor errors in an issued patent, such as typographical errors, omissions of an assignee, or printing of an original rather than amended claim, can be corrected with a Certificate of Correction. *See* §§ 254 (correction of USPTO mistake); 255 (correction of applicant mistake). These corrections cannot add new matter or change the scope of a patent claim such that reexamination would be required.⁵

Prior to the enactment of the AIA, a patent's named inventors could be corrected only upon showing that the error was made without deceptive intent. *See* § 256. Beginning September 16, 2012, inventorship errors may be corrected regardless of whether the error resulted from deceptive intent. AIA § 20.

Failure to inspect and correct an issued patent can be costly for the patentee. In *Southwest Software, Inc. v. Harlequin, Inc.*, 226 F.3d 1280 (Fed. Cir. 2000), the USPTO neglected to include a 330-page appendix with the issued patent. *Id.* at 1287. The accused infringer raised the issue during litigation. *Id.* at 1287–89. The patentee subsequently had the patent corrected under § 254. *Id.* at 1287. Nonetheless, the Federal Circuit held that a correction is only effective for causes of action arising after it was issued and remanded the case to determine whether the specification failed to satisfy the best mode and enablement requirements absent the appendix. *Id.* at 1295–97. The court stated, “[I]t does not seem to us to be asking too much to expect a patentee to check a patent when it is issued in order to determine whether it contains any errors that require the issuance of a certificate of correction.” *Id.* at 1296.

14.2.5.3 Supplemental Examination

The AIA added § 257 to Title 35, under which a patentee may seek supplemental examination to have the USPTO consider any additional information relevant to patentability. AIA § 12. The USPTO will grant supplemental examination if a “substantial new question of patentability” exists. A patent cannot be held unenforceable based on conduct relating to information that had not been considered or was incorrect during a prior examination if the information was subsequently considered or corrected during a supplemental examination. This procedure allows patentees to submit additional information or prior art in order to avoid potential inequitable conduct claims so long as the supplemental examination is completed before the patentee files suit. However, supplemental examination cannot be used to cure pre-

5. For example, the Court of Customs and Patent Appeals, which handled appeals of PTO rejections prior to the creation of the Federal Circuit, held that a patentee could correct, through a Certificate of Correction, a chemical name in a specification whose errors resulted from translation from Japanese to English. *See In re Oda*, 443 F.2d 1200 (C.C.P.A. 1971).

existing allegations of inequitable conduct. Supplemental examination became available for all patents on September 16, 2012.

14.2.5.4 Reissue

Whereas certificates of correction address minor, nonsubstantive alterations of an issued patent, reissue proceedings allow a patentee to correct a substantive defect in the specification or to narrow or broaden the scope of an issued patent. Reissue may occur when, because of error without deceptive intent, a patent is “deemed wholly or partly inoperative or invalid, by reason of a defective specification or drawing, or by reason of the patentee claiming more or less than he had a right to claim in the patent.” § 251. Under the AIA, reissue applications may be filed on or after September 16, 2012 without regard to deceptive intent. AIA § 20.

In pursuing reissuance of a patent, the patent owner files a reissue application and an oath attesting to the alleged error(s). The patent is then reprosecuted and may reissue in original or amended form. During the proceeding, the USPTO can reject any claims in the patent, not only those amended by the patentee. As a result, the entire patent loses its presumption of validity during the reissue process. The reissued patent is subject to invalidation in the same manner as the original patent (which is surrendered when the reissue patent is granted). Moreover, an accused infringer may defend on the grounds that the reissue itself was invalid.

The USPTO assigns reissued patents a new number, with the prefix “Re”—for example, “U.S. Patent No. Re. 50,000.” Unlike the original proceedings, CIP applications (i.e., addition of new matter) are not allowed, and third parties are notified of the reissue request and may submit evidence and arguments. The duration of a reissued patent term cannot extend beyond that of the original patent.

The USPTO requires the patentee to provide an oath or declaration attesting to at least one error in the original patent. *See* 37 C.F.R. § 1.175.⁶ Thus, reissue cannot be used to revive a patent rendered unenforceable because of inequitable conduct. The issued patent must contain “a defective specification or drawing,” or the patentee must have claimed “more or less than he had a right to claim.” § 251. Most patents are reissued to amend the claims, often to overcome newly discovered prior art that would invalidate one or more claims. Rather than filing a disclaimer that surrenders an entire claim or claims, the patentee can request reissuance with narrower claims that avoid the prior art. Furthermore, a reissue may be filed for the sole purpose of adding new dependent claims while leaving the original claims unchanged. *See In re*

6. The patentee is also held to a duty of candor regarding the reasons for the mistake. In *Hewlett-Packard Co. v. Bausch & Lomb, Inc.*, 882 F.2d 1556 (Fed. Cir. 1989), the patentee asserted a patent that was reissued with additional dependent claims. The original patent agent stated the additional claims were omitted from the original patent because of difficulty contacting the inventor, yet the record showed that the agent and inventor communicated regularly during prosecution. *Id.* at 1561. As a result, the Federal Circuit invalidated all claims added or amended during reissue, but did not disturb the unchanged claims from the original patent. *Id.* at 1566.

Tanaka, 640 F.3d 1246 (Fed. Cir. 2011). During the two-year window following issuance, a patentee can also attempt to broaden the scope of claim coverage, assuming that the original specification supports the amendments.

14.2.5.4.1 Narrowing Reissues

A patent owner may seek to narrow the scope of a patent at any point during the life of a patent.

14.2.5.4.2 Broadening Reissues

Broadening reissues are sought when the patentee's error is claiming less than the original specification, and presumably the prior art, would allow. The original specification must provide adequate written description for and must enable and disclose the best mode for the broader claim. A patentee has two years from the date of issuance to seek broader claims. § 251. The courts have construed this to mean "broader in any respect," so that an attempt to broaden a single claim limitation must be made within the two-year period, even if other amendments narrow the claim's overall scope. See *Ball Corp. v United States*, 729 F.2d 1429 (Fed. Cir. 1984). A patentee who has timely filed a broadening reissue application may continue to make broadening amendments outside the two-year window. See *In re Doll*, 419 F.2d 925 (C.C.P.A. 1970). But a patentee who sought a reissue within two years on other grounds cannot then seek to broaden claims outside the statutory period. See *In re Graff*, 111 F.3d 874 (Fed. Cir. 1997) (distinguishing *Doll* where the public was timely notified that the patentee sought broadened claims). A patentee's rights to enforce a broadening reissue are constrained by the doctrine of intervening rights. See § 252; § 14.2.5.5.2.2.

14.2.5.4.2.1 The Recapture Rule

The recapture rule is a judicially created limitation on broadening reissues that works similarly to prosecution history estoppel. See § 14.4.1.4.2.1.2. The rule bars a patentee from seeking reissue claims that regain subject matter that was surrendered to obtain allowance during the original prosecution. Surrendering subject matter to overcome patentability rejections does not constitute an "error" within the meaning of the patent laws. See *Ball Corp. v United States*, 729 F.2d 1429 (Fed. Cir. 1984).⁷

7. In *Mentor Corp. v. Coloplast, Inc.*, 998 F.2d 992 (Fed. Cir. 1993), Mentor had patented a condom catheter that transferred adhesive from the outer to inner surface during unrolling. The transfer limitation was added during prosecution to overcome an obviousness rejection. *Id.* at 995. After the patent issued, Mentor timely filed a broadening reissue application without the transfer limitation, asserting as error that it was entitled to the broader claim. *Id.* at 996. In a subsequent infringement action, the Federal Circuit held that Mentor's deliberate and intentional amendments made during initial prosecution to overcome issues of patentability were not errors within the meaning of the reissue statute and hence the broader reissued claim was invalid under the recapture rule. *Id.*

14.2.5.4.2.2 Intervening Rights

Although reissue claims that are “substantially identical” to those of the original patent “have effect continuously from the date of the original patent,” § 252 ¶ 1, claims that were modified at reissue, for any reason, are subject to a reliance-type interest referred to as intervening rights. *See* § 252 ¶ 2. This doctrine recognizes that third parties may rely on the claims of an issued patent and thus provides a safe harbor to parties practicing subject matter covered by the amended claims. Unlike the recapture rule, which can invalidate claims in a reissued patent, intervening rights are applied on a party-by-party basis.

The patent laws codify two types of intervening rights: absolute and equitable. Under the absolute intervening rights doctrine, a court may allow a party who “made, purchased, offered to sell, or used” anything prior to reissue to continue to use or sell that thing. § 252. These rights do not allow a party to make new items after the reissue is granted, only to use or sell products that were already in existence. In addition, there are no intervening rights for subject matter that was claimed in the original patent.

Equitable intervening rights allow a court to authorize continued practice of an invention claimed in a reissue patent “to the extent and under such terms as the court deems equitable for the protection of investments made or business commenced before the grant of the reissue.” *Id.* Again, these rights do not apply for inventions claimed in the original patent. As an example, a district court may provide equitable relief when a party has invested heavily in practicing the invention claimed at reissue. Such relief is subject to review by the Federal Circuit for abuse of discretion.⁸

Intervening rights can also apply when claims are narrowed. For example, a third party may practice a claimed invention in the belief that the applicable claims in the original patent are invalid. The patentee may later reissue the patent with narrowed claims that overcome the presumed invalidity arguments but still read on the third party’s activities. Under such circumstances, a court may apply the intervening rights doctrine to the narrowed reissue patent.

8. In *Seattle Box Co. v. Industrial Crating & Packing, Inc.*, 756 F.2d 1574 (Fed. Cir. 1985), Seattle Box patented a system for bundling oil pipes. Industrial Crating acquired materials to bundle pipes in such a way that did not literally read on Seattle Box’s claims. *Id.* at 1580. After bringing suit for infringement, Seattle Box obtained a broadening reissue that arguably covered Industrial Crating’s system. *Id.* at 1575. Industrial Crating assembled its bundles after the reissue was granted, and the district court denied the defense of intervening rights. *Id.* at 1576. The Federal Circuit reversed, holding that equitable intervening rights applied. *Id.* The Federal Circuit noted that Industrial Crating relied on advice of counsel when designing around the original patent and that it had pending orders for the unassembled inventory before the reissue was granted. *Id.* at 1580. The court observed that “the new reissue claims in this case present a compelling case for the application of the doctrine of intervening rights because a person should be able to make business decisions secure in the knowledge that those actions which fall outside the original patent claims are protected.” *Id.*

14.2.5.5 Reexamination

Reexamination is an administrative proceeding that can be initiated by the patentee, third parties, or the USPTO director, in which the USPTO reevaluates the validity of an issued patent. Prior to the AIA, the patent statute authorized two forms of reexamination: (1) *ex parte*, *see* §§ 302–307; and (2) *inter partes*, *see* pre-AIA §§ 311–318. The AIA left *ex parte* reexamination in place, but replaced *inter partes* reexamination with *inter partes* review (IPR), *see* § 14.2.5.6, though all *inter partes* reexaminations filed prior to September 16, 2012, will continue to completion. Reexaminations are limited to patentability issues raised by prior art patents and/or printed publications, as the USPTO is considered an expert in determining patentability over published prior art. Other issues affecting patentability, such as written description, enablement, “on sale” or public-use activities, or inequitable conduct, may require testimony and discovery, and thus are perceived as better handled through litigation.

14.2.5.5.1 The Reexamination Process

Reexaminations are handled by the USPTO’s Central Reexamination Unit (CRU), which has its own staff of examiners. The USPTO created the CRU in 2005 to improve the quality of reexamination proceedings and to reduce their pendency. By statute, all reexaminations must be handled with “special dispatch.” § 305; pre-AIA § 314.

A request for reexamination must provide new, noncumulative information affecting the patentability of a claim. Within three months of filing, the USPTO must issue a decision on whether to order a reexamination. For an *ex parte* reexamination, the threshold for ordering reexamination is whether the reexamination request raises a “substantial new question of patentability” (SNQ). § 303(a). Prior to the enactment of the AIA on September 16, 2011, the SNQ standard also applied to *inter partes* reexamination petitions. After the enactment of the AIA, however, the *inter partes* reexamination threshold was changed to “a reasonable likelihood that the requester would prevail with respect to at least 1 of the claims challenged in the request.” AIA § 6. The new threshold applies to *inter partes* reexaminations filed after September 15, 2011.

Unlike regular prosecution or reissue proceedings, there is no continuation practice in reexaminations. The patentee can appeal adverse rulings to the PTAB, and thereafter to the Federal Circuit. *See* §§ 305–306; pre-AIA §§ 314–315.

A reexamination terminates with the issuance of a “Reexamination Certificate” that becomes part of the official patent document and states the result (cancellation, confirmation, and/or amendment of claims) of the reexamination proceeding. § 307; pre-AIA § 316. If a patent claim is reaffirmed in reexamination, courts are likely to view it as stronger, thus benefiting the patentee. As with reissue, the doctrine of intervening rights applies to any claims added or amended during reexamination. *See* § 307, pre-AIA § 316.

14.2.5.5.2 Ex Parte Reexamination

Anyone can file a request for an ex parte reexamination. Once the USPTO orders an ex parte reexamination, the patentee may file a preliminary statement including proposed amendments or new claims so long as the amendments are supported by the original filing (§ 304) and do not enlarge claim scope. See *Quantum Corp. v. Rodime, PLC*, 65 F.3d 1577 (Fed. Cir. 1995) (invalidating patent where the USPTO allowed broadened claim scope during reexamination). If a third party requested the reexamination, it may respond to the patentee's preliminary statement, but any further proceedings in the reexamination involve only the patentee and the examiner. § 305. In practice, patentees often decline to submit preliminary statements to limit third-party participation. After the preliminary statement and reply period, ex parte reexamination resembles regular prosecution between an examiner and the patentee.

14.2.5.5.3 Inter Partes Reexamination

As a result of the enactment of the AIA, inter partes reexamination was phased out over a one-year transition period, beginning September 16, 2011. Starting September 16, 2012, inter partes review replaced inter partes reexamination. Inter partes reexaminations filed prior to September 16, 2012, will not, however, be converted into inter partes review proceedings, even if the proceedings have extended beyond September 16, 2012.

Inter partes reexamination was available only for patents granted on applications filed on or after November 29, 1999. See 37 C.F.R. § 1.913; *Cooper Techs. Co. v. Dudas*, 536 F.3d 1330, 1332–34 (2008). Unlike ex parte reexamination, requests for inter partes reexamination could not be filed by the patentee. Pre-AIA § 311; Pre-AIA 37 C.F.R. § 1.913. Inter partes reexamination allowed extensive involvement by the third-party requester throughout the proceedings, including appeal of adverse decisions to the PTAB and the Federal Circuit. Pre-AIA §§ 314–315.

Once the USPTO ordered an inter partes reexamination, the third-party requester was estopped from later arguing invalidity in a civil action on any ground that it raised, or could have raised, during the reexamination proceeding. Pre-AIA § 315(c). However, the third-party requester remained free to challenge the patent claims on other grounds, including newly discovered prior art unavailable to the third-party requester or the USPTO during the reexamination. *Id.*

14.2.5.5.4 Reexamination and Concurrent Litigation

It is not uncommon for an accused infringer to file a reexamination request for one or more of the patents-in-suit during litigation. Because reexaminations must proceed with “special dispatch” (§ 305; pre-AIA § 314), the USPTO Director cannot stay reexamination in light of concurrent litigation. *Ethicon, Inc. v. Quigg*, 849 F.2d 1422, 1426–27 (Fed. Cir. 1988). In contrast, district courts “have inherent power to manage their dockets and stay proceedings, including the authority to order a stay pending conclusion of a USPTO reexamination.” *Id.* The USPTO prioritizes reexaminations of patents involved in litigation.

During a reexamination proceeding, the USPTO evaluates patentability issues under a “preponderance of the evidence” standard, whereas the district court must still apply the “clear and convincing” standard to invalidate a patent claim undergoing reexamination. See *Ethicon*, 849 F.2d at 1427.

A district court’s finding that a patent was not proven invalid does not ordinarily create collateral estoppel effects on other courts or the USPTO during reexamination. *Ethicon*, 849 F.2d at 1429 n.3; see also *In re Swanson*, 540 F.3d 1368, 1379 (Fed. Cir. 2008) (“As properly interpreted a ‘substantial new question of patentability’ refers to a question which has never been considered by the USPTO; thus, a substantial new question can exist even if a federal court previously considered the question.”). In contrast, a final, nonappealable court decision finding invalidity bars enforcement of the patent in subsequent proceedings (see *Blonder-Tongue Labs., Inc. v. Univ. of Ill. Found.*, 402 U.S. 313 (1971)), and the USPTO may discontinue the reexamination. See *Ethicon*, 849 F.2d at 1429.

14.2.5.6 Inter Partes Review (IPR)

IPR replaced inter partes reexaminations on September 16, 2012. AIA § 6 (amending §§ 311–319). In an IPR, a third party may seek cancellation of at least one claim based on § 102 or 103 using only prior art patents or printed publications. IPR may be requested by anyone who is not the patent owner, and who has not previously filed a declaratory judgment action challenging the validity of the patent. The USPTO will grant IPR if the petition shows “a reasonable likelihood” that the petitioner would prevail on at least one claim being challenged. The USPTO’s decision on whether to institute an IPR is unappealable. See *In re Cuozzo Speed Techs., LLC*, 778 F.3d 1271 (Fed. Cir. 2015). IPR is handled by the PTAB rather than by the CRU, and appeals are taken directly to the Federal Circuit.

During IPR, the standard for proving invalidity is by a preponderance of the evidence, the parties may engage in limited discovery, and the patentee has an opportunity to provide comments and/or propose claim amendments that do not enlarge claim scope. With regard to patents filed under the AIA’s first-to-file regime (and not patents filed prior to March 16, 2013), a petition for IPR cannot be filed until after the later of: (1) the closing of the postgrant review (PGR) window, that is, nine months after the grant (or reissue) of a patent, or (2) the termination of any PGR. The statute requires the USPTO to issue a final determination of the IPR no later than a year after instituting the proceeding; this deadline may be extended up to six months for good cause.

If, after filing a petition for IPR, the petitioner initiates a civil action seeking a declaratory judgment of invalidity of the same patent, the civil action is automatically stayed. The automatic stay is lifted if the patentee moves the court to lift the stay or asserts the patent against the petitioner in a civil action or in a counterclaim. Because the automatic stay provisions apply to “civil actions” rather than counterclaims, a petitioner is able to assert invalidity counterclaims while seeking IPR. A petition for IPR may not be filed more than one year after the date on which the patentee served the petitioner with a complaint for infringement of the patent.

In any subsequent proceeding in the USPTO, the district courts, or the ITC, the petitioner is estopped from raising issues that it had raised or reasonably could have raised during IPR. If the parties settle during IPR, there is no estoppel effect. In a manner similar to reissue claims, intervening rights attach to new or amended claims that emerge from IPR.

14.2.5.7 Postgrant Review (PGR)

Under §§ 321–329, AIA § 6, anyone other than the patentee may petition for postgrant review of a patent within nine months of grant or reissue based on any ground of invalidity. The PTAB will institute a postgrant review if it determines that it is more likely than not that at least one of the claims is unpatentable, or the petition raises a legal issue important to other patents or patent applications. If multiple postgrant review petitions are filed, the USPTO may consolidate them. The denial of a petition is unappealable.

The standard for proving invalidity in a postgrant review proceeding is by a preponderance of the evidence. The AIA provides limited discovery for the parties. The patentee has an opportunity to provide comments and/or propose claim amendments, but claim scope may not be enlarged. The statute requires the USPTO to issue a final determination no later than a year after instituting the proceeding; this deadline can be extended up to six months for good cause. In any subsequent proceeding in the USPTO, the district courts, or the ITC, the petitioner is estopped from raising issues that it had raised or reasonably could have raised during postgrant review. If the parties settle during postgrant review, there is no estoppel effect.

A party that has previously filed an action seeking a declaratory judgment of invalidity cannot petition for postgrant review. If, during the postgrant review proceeding, the petitioner files a declaratory judgment action, that action is stayed unless the patentee counterclaims for infringement. If the patentee files an action to assert the patent within three months of issuance, a court may not delay consideration of a motion for preliminary injunction on the ground that a postgrant review petition has been filed or that a postgrant review proceeding has been instituted. In a manner similar to reissue claims, intervening rights attach to new or amended claims that emerge from postgrant review. *See* § 14.2.5.4.2.2.

Postgrant review proceedings apply to claims with effective filing dates after March 15, 2013.

14.2.5.7.1 Covered Business-Method Review (CBMR)

The AIA provides for a variant of the postgrant review proceeding for business-method patents of all filing dates. Under the Transitional Program for Covered Business Method Patents, CBMR may be requested for a business-method patent that has been asserted against the requester, either in court or with allegations of infringement. AIA § 18. Courts may stay concurrent district court proceedings pending a CBMR, but the decision whether to grant a stay is subject to interlocutory review. This transitional program began September 16, 2012, and ends September 16, 2020.

Like postgrant review, and unlike IPR, patent validity can be challenged on any ground. Additionally, no time-bar exists in CBMR; a petitioner does not have to file within a certain period of time from being named defendant in a suit or from an accusation of patent infringement. The estoppel provision is also weakened. A petitioner is estopped from arguing any ground *actually* raised in CBMR in subsequent district court or ITC proceedings. However, a petitioner still faces estoppel based on anything that reasonably could have been raised in subsequent proceedings at the USPTO.

14.2.5.7.2 Postgrant, Inter Partes, and Covered Business-Method Review and Concurrent Litigation

Similar to reexamination, accused infringers commonly file a review request for one or more of the patents-in-suit during litigation. Reviews must ordinarily be completed within twelve months from an institution decision (with an outer bound of eighteen months upon showing of good cause) and cannot be stayed. Much of the analysis to stay a case pending a review is the same as with reexamination; however, one important exception applies.

In addition to the three traditional considerations courts weigh to decide whether to stay a case, Congress added a fourth to be considered when litigation is co-pending with CBMR of a patent: “whether a stay, or the denial thereof, will reduce the burden of litigation on the parties and the court.” AIA § 18. As mentioned above, the grant or denial of a stay is subject to interlocutory review.

Table 14.2 summarizes the principal features of and differences between the AIA review procedures.

Table 14.2
Significant Differences Between AIA Reviews

AIA Review	Inter Partes	Postgrant	Business-Method
Evidentiary Standard	Petitioner to prove invalidity by the preponderance of the evidence		
Grounds for Review	§ 102, § 103	Any defense relating to invalidity	
Prior Art Limited to:	Patents and printed publications	No Limits	
Threshold to Institute Review	Reasonable likelihood that one or more claims invalid	More likely than not, at least one claim is unpatentable, or petition raises a novel legal question of patentability.	
Time to Institution	Maximum of 6 months		
Time to Decision	Maximum of 12–18 months from institution decision		
Claim Amendments	Patent owner may cancel claims or propose a reasonable number of substitute claims. Presumption that only one substitute claim will be required for each challenged claim		
Claim Construction	“Broadest reasonable construction in light of specification”		
Stay Considerations:	1) Stay simplify issues and streamline trial? 2) Is discovery complete, trial date set? 3) Stay tactically advantage moving party or unduly burden nonmoving party?	<i>AIA Consideration:</i> 4) Stay reduce burden on the parties and the court?	
Estoppel in Subsequent Civil Action	Any ground raised or that reasonably could have been raised	Any ground <i>actually</i> raised	
Effect of Settlement	Estoppel provisions do not apply.		

14.2.6 The Presumption of Validity

The 1952 Patent Act codified the judge-made presumption that the rigor of the USPTO’s examination process should render an issued patent presumptively valid. Thus, a patent is presumed valid and a party asserting invalidity must prove the facts to establish a claim’s invalidity by clear and convincing evidence. § 282; *Microsoft Corp. v. i4i Ltd. P’ship*, 131 S. Ct. 2238 (2011); *Kaufman Co. v. Lantech, Inc.*, 807 F.2d 970, 973–74 (Fed. Cir. 1986).

The “clear and convincing” standard applies to questions of fact and not to questions of law. The factual and legal aspects of an invalidity claim may be separated “by using instructions based on case-specific circumstances that help the jury make the distinction or by using interrogatories and special verdicts to make clear which spe-

cific factual findings underlie the jury’s conclusions.” *Microsoft*, 131 S. Ct. at 2253 (Breyer, J. concurring) (citing Fed. R. Civ. P. 49 and 51).

Where the references asserted against a claim’s validity were not presented to the USPTO examiner, “the challenger’s burden to persuade the jury of its invalidity defense by clear and convincing evidence may be easier to sustain.” *Microsoft*, 131 S. Ct. at 2251. The Federal Circuit has similarly observed that the burden of proof may “be facilitated” or more easily met if the examiner never considered the asserted reference. *Kaufman*, 807 F.2d at 973; *Jervis B. Webb Co. v. S. Sys., Inc.*, 742 F.2d 1388, 1393 n.4 (Fed. Cir. 1984). In such situations, “the jury may be instructed to evaluate whether the evidence before it is materially new, and if so, to consider that fact when determining whether an invalidity defense has been proved by clear and convincing evidence.” *Microsoft*, 131 S. Ct. at 2251.

14.3 Validity

A patent claim must meet five requirements to issue as part of a valid patent: (1) patentable subject matter, (2) utility, (3) disclosure, (4) novelty, and (5) non-obviousness. Failure to clear any one of these hurdles will invalidate the patent claim.

14.3.1 Patentable Subject Matter (§ 101)

Section 101 authorizes protection for “any” “process, machine, manufacture, or composition of matter” or “improvement thereof . . . subject to the conditions and requirements of this title.” Although the Patent Act has not excluded any subject matter for much of U.S. history,⁹ courts have long recognized subject-matter eligibility limitations. These limits emerged during the early to mid-nineteenth century as Anglo-American, common-law-trained jurists fleshed out the relatively terse patent law eligibility requirements.

Thus, the contours of these doctrines are found not in the text of the Patent Act but rather in two centuries of jurisprudence that has ebbed and flowed with technological advance, perspectives on scientific discovery, and concerns about the patent system stifling new inventions. Patent-eligibility doctrines lost salience from the early 1980s through 2009 as the Federal Circuit substantially liberalized the scope of patentable subject matter. The Supreme Court was dormant in patentable subject-matter jurisprudence during this period. The Supreme Court reentered the arena in 2010 and has since issued four significant opinions reinvigorating patentable subject-matter eligibility limitations and, in so doing, making this area ripe for litigation. See *Bilski v. Kappos*, 561 U.S. 593 (2010); *Mayo Collaborative Servs. v. Prometheus Labs., Inc.*, 132 S. Ct. 1289 (2012); *Ass’n for Molecular Pathology v. Myriad Genetics, Inc.*, 133 S. Ct. 2107 (2013); *Alice Corp. Pty. Ltd. v. CLS Bank Int’l*, 134 S. Ct. 2347 (2014). Most patents in effect today issued during the period in which subject-matter

9. As noted in §§ 14.3.1.3.1–2, the AIA excludes patents on tax strategies and human organisms.

eligibility was perceived to be very broad. Hence, the courts have seen a large and growing number of challenges to patent validity based on § 101 since 2010.

Navigating the boundaries of patentable subject matter entails careful study of the Supreme Court's recent decisions as well as the history leading up to those cases. The Supreme Court's predilection for considering all of its prior patentable subject-matter cases to be consistent poses notable interpretive challenges. Thus, it will be useful to examine the case law through a variety of lenses. The next section states the core principles undergirding modern Supreme Court jurisprudence. The following sections trace the history of these doctrines, examine particular subject-matter areas, and explore the challenges of applying patent-eligibility doctrines.

14.3.1.1 Modern Core Principles: Ineligible Subject Matter and Inventive Application

The Supreme Court's most recent patentable subject-matter decision, *Alice*, synthesizes two centuries of jurisprudence into a two-part test:

Step 1: Does the patent claim a patent-ineligible law of nature, natural phenomena, or abstract idea?

Step 2: If so, does the claim contain an inventive concept sufficient to transform the ineligible law of nature, natural, phenomena, or abstract idea into a patent-eligible application of the ineligible subject matter?

Alice, 134 S. Ct. at 2354. The exclusion of claims covering laws of nature, natural phenomena, and abstract ideas reflects the concern, sometimes referred to as the preemption rationale, that patents not unduly inhibit further discovery by tying up basic building blocks of human ingenuity. Step 2 requires that the patentee not merely *apply* the law of nature, natural phenomena, or abstract idea, but rather do so in an *inventive* manner. The application cannot be routine or conventional, but must be inventive above and beyond the discovery of the underlying law of nature, physical phenomena, or algorithm.

This characterization of patent eligibility potentially excludes some of the most important and difficult technological discoveries from patent protection: the discovery of laws of nature. During earlier eras, inventors could obtain patents on applications of such discoveries even if their *application* was conventional. The Supreme Court's recent jurisprudence, however, excludes routine or conventional applications of breakthrough scientific biomedical or algorithmic discoveries from patent eligibility. See *Ariosa Diagnostics, Inc. v. Sequenom, Inc.*, 788 F.3d 1371 (Fed. Cir. 2015) (invalidating a patent on noninvasive prenatal diagnostic methods on the ground that the *application* of the discovery that cell-free fetal DNA existed in maternal blood was not inventive); *cf. id.* at 1380 (Linn, J. concurring) (observing that “[t]his case represents the consequence—perhaps unintended—of that broad language [in the Supreme Court's *Mayo* decision] in excluding a meritorious invention from the patent protection it deserves and should have been entitled to retain”).

The requirement of not merely *application* but *inventive* application of patent-ineligible subject matter overlaps with the § 103 nonobviousness requirement. Upon closer examination, however, the inventiveness required for § 101 eligibility is dis-

tinct from and arguably more demanding than § 103 nonobviousness analysis. According to *Mayo*, the inventive application requirement treats the patentees' discovery of the law of nature, physical phenomena, abstract ideas, or algorithms (in *Flook*) as known (even where it was not), whereas § 103 nonobviousness focuses on "the differences between the claimed invention and the prior art." See § 14.3.5.3.3. The rationale for this distinction apparently derives from the notion that laws of nature, physical phenomena, and abstract ideas are basic building blocks of human ingenuity. They are not invented by humans but merely discovered. The fact that § 101 of the Patent Act confers patent eligibility on "[w]hoever invents or *discovers* any new and useful process, machine, manufacture, or composition of matter, or any new and useful improvement thereof . . .," however, only adds to the confusion.

As the evolution of these doctrines reveals, the Supreme Court's emphasis on *inventive* application rests on a questionable jurisprudential foundation. See generally Jeffrey A. Lefstin, *67 Inventive Application: A History*, Fla. L. Rev. 565 (2015). Nonetheless, unless and until the doctrine's provenance is rectified, lower courts must work within this framework. Understanding the evolution of patent-eligibility jurisprudence illuminates the current state of the law and provides some guidance in applying the inventive application doctrine.

14.3.1.2 The Evolution of Patentable Subject-Matter Limitations

Like the modern Patent Act, the nation's first patent statutes authorized the granting of patents for a broad range of subject matter—"any new and useful art, machine, manufacture, or composition of matter"¹⁰—without express subject-matter limitations. Courts came to recognize that patentability of broad scientific principles and abstract claims created the need for patent-eligibility and scope limitations—what we today consider § 112 concerns. These concepts were intertwined in the early jurisprudence and continue to overlap today.

10. See Patent Act of 1793, Act of Feb. 21, 1793, 1 Stat. 318. This language parallels the modern subject matter categories with the replacement of the term "art" with "process." This shift reflects the evolution of language as opposed to substantive change. See H.R. Rep. No. 82-1923, A Bill to Revise and Codify the Laws Relating to Patents and the Patent Office, and to Enact into Law Title 35 of the United States Code Entitled "Patents," at 5–6, 82d Cong., 2d Sess. (1952). The concept of a "useful art" during the nation's formative period connoted guilds and trades utilizing what we would today call "technology." During the nineteenth century, courts defined "art" as "a new process or method of working or of producing an effect or result in matter." See George Ticknor Curtis, *A Treatise on the Law of Patents for Useful Inventions, as Enacted and Administered in the United States of America* 28 (3d ed. 1867). In explaining the substitution of "process" for "art," the drafters of the 1952 Act explained that the change was not substantive. Section 100 of the 1952 Act defined "process" to include "process, art or method, and includes a new use of a known process, machine, manufacture, composition of matter, or material." See generally Peter S. Menell, *Forty Years of Wondering in the Wilderness and No Closer to the Promised Land: Bilski's Superficial Textualism and the Missed Opportunity to Ground Patent Interpretation and Return Patent Law to Its Technology Mooring*, 63 Stan. L. Rev. 1289 (2011).

14.3.1.2.1 Early Development of Patent-Eligibility Limitations

In the years following the nation's founding, English cases substantially influenced American jurisprudence. The United States inherited many English legal traditions. This was especially true of intellectual property law, which closely followed English formulations and interpretations.

With the industrial revolution gaining momentum, courts on both sides of the Atlantic struggled to deal with the patentability and scope of path-breaking inventions such as the steam engine, hot blast furnace, sewing machine, telegraph, and telephone. The patenting of the hot blast process, which industrial historians came to view as "the most important single innovation in the industry in the age of iron," see Alan Birch, *The Economic History of the British Iron and Steel Industry 1784–1879*, 181 (1968), would prove especially important to patent-eligibility doctrine.

Scottish inventor James Beaumont Neilson challenged the conventional wisdom that hot-blast furnaces would function most effectively if they were fed cold air. Neilson's patent claimed preheating of air entering furnaces, and this preheating revolutionized the production of iron by substantially reducing the fuel required and enabling the use of raw coal and lower-quality ores. His brief specification provided few details and declared that "[t]he form or shape of the receptacle is immaterial to the effect," as were the composition of the air vessel and the manner of applying heat.

He would sue numerous ironmakers for patent infringement, leading to the important decision in the English Court of the Exchequer, *Neilson v. Harford* (1841), that continues to reverberate in U.S. patentable subject-matter jurisprudence today. The patent was attacked on two principal grounds: (1) that it was not sufficiently described; and (2) that a patent for injecting hot air into the furnace, instead of cold, and thereby increasing the intensity of the heat, was a patent for a principle, and that a principle was not patentable. The jury found that a skilled artisan could, based on the specification, construct an improved hot blast furnace. Therefore, the patent was sufficiently described.

The second issue would prove especially important. In upholding the patent, Judge Baron Parke explained:

It is very difficult to distinguish it from the specification of a patent for a principle, and this at first created in the minds of the court much difficulty; but after full consideration we think that the plaintiff does not merely claim a principle, but a machine, embodying a principle, and a very valuable one. We think the case must be considered as if the principle being well known, the plaintiff had first invented a mode of applying it by a mechanical apparatus to furnaces, and his invention then consists in this: by interposing a receptacle for heated air between the blowing apparatus and the furnace. In this receptacle he directs the air to be heated by the application of heat externally to the receptacle, and thus he accomplishes the object of applying the blast, which was before cold air, in a heated state to the furnace.

The court reasoned that since the principle worked regardless of the dimensions of the receptacle in which the air was preheated before injection into the furnace, Neilson's invention applied the principle and hence, even though very broad (and arguably preemptive of the preheating principle), was patent-eligible. It is notable that the English court did *not* require *inventive* application of the law of nature

(that preheating air before injection into a hot-blast furnace will allow for more efficient fuel usage and higher temperatures) for patent eligibility. The preheating receptacles and bellows were in the prior art. Rather it was recognition and application of the natural law that provided the basis for patent eligibility, not the inventiveness (or lack thereof) of the means of harnessing the natural law.

U.S. decisions followed this approach, barring protection for a mere “principle,” “motive” force, or “new power” in the abstract. The Supreme Court explained in *Le Roy v. Tatham*, a case involving improved machinery for manufacturing lead pipe and a new property (the manufacture of wrought pipe from solid lead), that

[a] principle, in the abstract, is a fundamental truth; an original cause; a motive; these cannot be patented, as no one can claim in either of them an exclusive right. Through the agency of machinery a new steam power may be said to have been generated. But no one can appropriate this power exclusively to himself, under the patent laws. The same may be said of electricity, and of any other power in nature, which is alike open to all, and may be applied to useful purposes by the use of machinery.

In all such cases, the processes used to extract, modify, and concentrate natural agencies, constitute the invention. The elements of the power exist; the invention is not in discovering them, but in *applying* them to useful objects. . . .

55 U.S. 156, 1775 (1853) (emphasis added). The case approvingly discussed the *Neilson* case. *See id.* at 175–76; *see also id.* at 180–82, 185 (Nelson, J. dissenting).

The U.S. Supreme Court addressed *Neilson* in *O’Reilly v. Morse*, 56 U.S. 62 (1853), a case concerning the patenting of the telegraph. In addition to claims relating to the particular apparatus, Morse sought protection for “the use of the motive power of the electric or galvanic current, which I call electro-magnetism, however developed, for making or printing intelligible characters, letters, or signs, at any distances. . . .” *Id.* The breathtaking scope of this final claim led the Court to consider the principles enunciated in *Neilson v. Harford*. *Id.* at 62–63. While endorsing the requirement that patents must apply a law of nature, the Court nonetheless distinguished *Neilson*’s claim from Morse’s final claim. *Id.* Whereas the effect that *Neilson* claimed (improving the functioning of a hot-blast furnace) produced the desired effect for “whatever might be the form of the receptacle, or the mechanical contrivances for heating it, or for passing the current of air through it, and into the furnace,” Moore had “not discovered, that the electric or galvanic current will always print at a distance, no matter what may be the form of the machinery or mechanical contrivances through which it passes.” *Id.* at 116–17. Thus, Morse’s final broad claim was invalid for reasons that we would today characterize as overbreadth (§ 112 written description), not ineligible subject matter (§ 101). Yet the Court’s invocation of *Neilson* would take on great significance in American patent-eligibility jurisprudence a century later.

By the end of the nineteenth century, American patent-eligibility doctrine merely required that the patentee “carry the principle into effect, however simple and self-evident such means may be.” *See* David Fulton, *The Law and Practice Relating to Patents, Trade Marks and Designs* 41 (1902); *see also* Robert Frost, *A Treatise on the Law and Practice of Letters Patent for Inventions* 36 (1891) (“Prin-

ciples in a concrete form, together with a mode of applying them to a new and useful purpose, may form the subject of a grant of letters patent. . . . It is not necessary that the means, as well as the principle, should be new, for the novelty of the invention consists in applying the new principle by the means specified.”). This view continued well into the twentieth century. See Caesar & Rivise, *Patentability and Validity*, §§ 33, 34 (1936) (observing that “[i]n the cases where the inventor was required to be also the discoverer of the law or force utilized, it appeared that the application or utilization of the law became self-evident as soon as the principle was formulated”).

14.3.1.2.2 *Funk Brothers* (1948): The Emergence of Inventive Application

The *inventive* application eligibility concept first emerged in *Funk Brothers Seed Co. v. Kalo Inoculant Co.*, 333 U.S. 127 (1948). The claimed invention concerned bacteria cultures used to fix nitrogen in leguminous (pea and bean) plants, which is essential to promoting plant growth. At the time that the claimed invention was made, it was known that bacteria of the genus *Rhizobium* naturally exist in symbiotic association with leguminous plants. *Id.* at 128. Farmers routinely mixed *Rhizobium* cultures with leguminous plants to enhance nitrogen fixation. *Id.* at 129. Unfortunately, particular species of the *Rhizobium* genus infect only particular legumes. *Id.* Attempts at mixing different *Rhizobium* species into a single commercial product generally proved unsuccessful, as the bacteria species exerted inhibitory effects on each other when mixed together. *Id.* As a result, farmers would need to apply separate cultures for each leguminous crop, raising their costs and complicating the application of the bacteria. *Id.* at 129.

The inventor discovered that particular combinations of naturally occurring *Rhizobium* bacteria were not inhibitory and, therefore, could be packaged together into a product that could be applied across leguminous plant varieties more conveniently. *Id.* at 130. The patent broadly claimed the method of producing the bacteria mix as well as a broad composition of matter: “[a]n inoculant for leguminous plants comprising a plurality of selected mutually noninhibitive strains of different species of bacteria of the genus *Rhizobium*, said strains being unaffected by each other in respect to their ability to fix nitrogen in the leguminous plant for which they are specific.” *Id.* at 128 n.1. The composition-of-matter claim covered all mutually noninhibitory combinations of the *Rhizobium* genus. *Id.* at 137.

A divided Supreme Court invalidated the patent on the ground that it did “not disclose an invention or discovery within the meaning of the patent statutes.” *Funk Brothers*, 333 U.S. at 132. Justice Douglas’s majority opinion began its analysis by restating well-established patent-eligibility jurisprudence:

[P]atents cannot issue for the discovery of phenomena of nature. The qualities of these bacteria, like the heat of the sun, electricity, or the quality of metals, are part of the storehouse of knowledge of all men. They are manifestations of laws of nature, free to all men and reserved exclusively to none. He who discovers a hitherto unknown phenomenon of nature has no claim to a monopoly of it which the law recognizes. If

there is to be invention from such a discovery, it must come from the *application* of the law of nature to a new and useful end.

Id. at 130 (citations omitted; emphasis added). The following paragraph, however, introduces the idea that merely applying a law of nature is insufficient.

Discovery of the fact that certain strains of each species of these bacteria can be mixed without harmful effect to the properties of either is a discovery of their qualities of non-inhibition. It is no more than the discovery of some of the handiwork of nature and hence is not patentable. *The aggregation of select strains of the several species into one product is an application of that newly-discovered natural principle.* But however ingenious the discovery of that natural principle may have been, the application of it is hardly more than an advance in the packaging of the inoculants.

Id. at 131 (emphasis added). Justice Douglas acknowledged that the inventor had applied the law of nature, but nonetheless invalidated the claim as insufficiently inventive in its application of the newly discovered natural principle. *Id.* The Court noted that

a product must be more than new and useful to be patented; it must also satisfy the requirements of invention or discovery. *Cuno Engineering Corp. v. Automatic Devices Corp.*, 314 U.S. 84, 90, 91 (1941), and cases cited; 35 U.S.C. § 31. The application of this newly-discovered natural principle to the problem of packaging of inoculants may well have been an important commercial advance. But once nature's secret of the non-inhibitive quality of certain strains of the species of *Rhizobium* was discovered, the state of the art made the production of a mixed inoculant a simple step. Even though it may have been the product of skill, it certainly was not the product of invention.

Id. at 131–32.

In a concurring opinion, Justice Frankfurter offered an alternative basis for invalidation reminiscent of the *Morse* decision. In his view, the patent was invalid not for unpatentable subject matter but rather for want of adequate identification of successful combinations of mutually noninhibitory bacteria. *Funk Brothers*, 333 U.S. at 133. He went on to observe that

[i]t only confuses the issue . . . to introduce such terms as “the work of nature” and the “laws of nature.” For these are vague and malleable terms infected with too much ambiguity and equivocation. Everything that happens may be deemed “the work of nature,” and any patentable composite exemplifies in its properties “the laws of nature.” Arguments drawn from such terms for ascertaining patentability could fairly be employed to challenge almost every patent.

Id. at 134–35.¹¹

Following *Funk Brothers*, several appellate decisions implemented its holding, treating newly discovered scientific principles to be unpatentable and requiring *inventive* application of such principles. See, e.g., *Davison Chem. Corp. v. Joliet Chems., Inc.*, 179 F.2d 793 (7th Cir. 1950); *In re Arnold*, 185 F.2d 686 (C.C.P.A. 1950); *Nat'l Lead Co. v. W. Lead Prods. Co.*, 324 F.2d 539 (9th Cir. 1963).

11. Justices Burton and Jackson dissented, finding the product claims within the scope of patentable subject matter and adequately disclosed. *Funk Brothers*, 333 U.S. at 136.

14.3.1.2.3 The New Technological Age

With the dawning of the digital age, the Supreme Court returned to patent-eligibility cases. The inventor in *Gottschalk v. Benson*, 409 U.S. 63 (1972), claimed an algorithm for converting binary-coded decimal numerals into pure binary numerals. In upholding the USPTO’s rejection of the patent on subject-matter grounds, a unanimous Court, drawing upon *Le Roy*, *Morse*, and *Funk Brothers*, articulated three principles for determining whether a process is patentable: (1) “[p]henomena of nature, though just discovered, mental processes, and abstract intellectual concepts are not patentable, as they are the basic tools of scientific and technological work,” *id.* at 67; (2) “[t]ransformation and reduction of an article ‘to a different state or thing’ is the clue to the patentability of a process claim that does not include particular machines,” *id.* at 70; and (3) algorithms may not be patented so as to avoid the practical effect of “wholly pre-empt[ing a] mathematical formula,” *id.* at 71. Echoing concerns raised by various amicus briefs, the Court concluded by calling on Congress to take up the question of whether and to what extent computer programs ought to be patentable. *See id.* at 71–73.

Six years later in *Parker v. Flook*, 437 U.S. 584 (1978), the Supreme Court addressed whether a procedure for updating an alarm limit—measuring the present value of a process variable (such as temperature), using an algorithm to calculate an updated alarm-limit value, and adjusting the updated value—was eligible for patent protection. Writing for the majority in a sharply divided opinion, Justice Stevens expressly embraced the *inventive application* doctrine in upholding the USPTO’s rejection of the claim. In an apparent misinterpretation, the Court grounded the doctrine on the statement in *Neilson* that “‘the case must be considered as if the principle being well known, the plaintiff had first invented a mode of applying it’” *Flook*, 437 U.S. at 592 (quoting *Morse*, quoting *Neilson*). Based on this sentence from *Neilson*, the Supreme Court reasoned that “this case must also be considered as if the principle or mathematical formula were well known” and that patent eligibility required sufficient inventiveness beyond the application of the algorithm to be within the scope of patentable subject matter. *Id.* at 592, 594–95. As the Court declared:

Even though a phenomenon of nature or mathematical formula may be well known, an *inventive application* of the principle may be patented. Conversely, the discovery of such a phenomenon cannot support a patent unless there is some other *inventive concept* in its application.

Id. at 594 (emphasis added).

Justice Stevens countered suggestions that such an approach “improperly imports considerations of ‘inventiveness’” from §§ 102 and 103 into the § 101 analysis, noting that “[t]he obligation to determine what type of discovery is sought to be patented must precede the determination of whether that discovery is, in fact, new or obvious.” *Id.* at 594.

Like the Court’s opinion in *Benson*, the majority opinion concluded with a call for Congress, with its access to empirical evidence, rather than the courts, to take on the patentability of computer programs. *Id.* at 595–96. The opinion also invoked an

interpretive principle of parsimony: “[W]e should not expand patent rights by overruling or modifying our prior cases construing the patent statutes, unless the argument for expansion of privilege is based on more than mere inference from ambiguous statutory language.” *Id.* at 595 (quoting *Deepsouth Packing Co. v. Laitram Corp.*, 406 U.S. 518, 531 (1972)).¹²

Justice Stewart, with whom Chief Justice Burger and Justice Rehnquist joined, did not see the patent at issue as preempting use of the algorithm, but rather as a potentially patentable application of it. *Id.* at 599. He criticized the majoring opinion for excluding a process from the scope of patentable subject matter because “one step in the process would not be patentable subject matter if considered in isolation,” observing that “thousands of processes and combinations have been patented that contained one or more steps or elements that themselves would have been unpatentable subject matter.” *Id.* (citation omitted; emphasis in original). The majority opinion responded to this contention by noting that the process is unpatentable “not because it contains a mathematical algorithm as one component, but because once that algorithm is assumed to be within the prior art, the application, considered as a whole, contains no patentable invention.” *Id.* at 594.

In the midst of the controversy over the patentability of computer software, the Supreme Court confronted the patentability of genetically modified organisms. See *Diamond v. Chakrabarty*, 447 U.S. 303 (1980). The inventor claimed a self-replicating bacterium into which he had injected oil-degrading plasmids that could be used in dispersing oil spills. *Id.* at 305. The USPTO rejected the claim on the grounds that microorganisms are “products of nature” and living things, both of which make them ineligible for patent protection under § 101. *Id.* at 306. The Court of Customs and Patent Appeals reversed, upholding the claim under the standards set forth in *Flook*. *Id.*

The Supreme Court affirmed the appellate court decision, opening the way for patent protection for genetically modified organisms. *Id.* at 318. Writing for the majority, Chief Justice Burger characterized the Constitution’s grant of patent legislative authority and § 101’s text broadly. *Chakrabarty*, 447 U.S. at 307–08. While recognizing the unpatentability of “laws of nature, physical phenomena, and abstract ideas,” the Court judged Chakrabarty’s claim to a “nonnaturally occurring manufacture or composition of matter—a product of human ingenuity “having a distinctive name, character [and] use”—to “plainly” qualify for patent eligibility. *Id.* at 309–10 (quoting *Hartranft v. Wiegmann*, 121 U.S. 609, 615 (1887)). Drawing a contrast to *Funk Brothers*, the Court noted that Chakrabarty “has produced a new bacterium with markedly different characteristics from any found in nature and one having the po-

12. The Court was quite aware of the larger policy concerns surrounding the case. In discussing the procedural background to the case, the Court observed that “[t]he Acting Commissioner of Patents and Trademarks filed a petition for a writ of certiorari, urging that the decision of the Court of Customs and Patent Appeals will have a debilitating effect on the rapidly expanding computer ‘software’ industry, and will require him to process thousands of additional patent applications.” *Flook*, 437 U.S. at 587–88.

tential for significant utility. His discovery is not nature’s handiwork, but his own.” *Id.* at 310.

Moreover, *Chakrabarty* interpreted the scope of patent-eligible subject matter expansively, stressing that § 101 encompasses any invention falling within the four designated categories. *Id.* at 308–09. The Supreme Court also looked to the legislative history of the 1952 Patent Act, from which it concluded that “Congress intended statutory subject matter to ‘include anything under the sun that is made by man.’”¹³ *Id.* at 309.

Propelled in part by *Chakrabarty*’s broad reading of patent eligibility, the pendulum swung decisively in the opposite direction of *Flook* three years after it was rendered. The USPTO rejected a patent application claiming a process for molding raw, uncured, synthetic rubber into cured precision products using a computer program, a known algorithm to calculate the cure time, and continuous measurement of the internal temperature. After the Court of Customs and Patent Appeals overturned the § 101 rejection, the USPTO sought certiorari based on the *Flook* decision:

13. The full passage from which this quotation was taken is arguably less expansive. The “anything under the sun” phrase arises in the section of the House Report describing “Part II” of Title 35, which “relates to patentability of inventions and the grant of patents.” H.R. Rep. No. 82-1923, at 6. This discussion begins with four paragraphs explaining § 101: the first two deal with the subject matter categories; the second two focus on the final clause of § 101.

The first and longest paragraph begins by stating that Section 101 “specifies the type of material that can be the subject matter of a patent,” thus implying that there are types of material that are not within the scope of patentable subject matter. The second paragraph explains that the definition of “process” was added in § 100 “to make it clear that ‘process or method’ is meant, and also to clarify the present law as to the patentability of certain types of processes or methods as to which some insubstantial doubts have been expressed.” *See id.* The next two paragraphs explain the final clause of Section 101:

Section 101 sets forth the subject matter that can be patented, “subject to the conditions and requirements of this title.” The conditions under which a patent may be obtained follow, and section 102 covers the conditions relating to novelty.

A person may have “invented” a machine or manufacture, which may include anything under the sun that is made by man, but it is not necessarily patentable under section 101 unless the conditions of the title are fulfilled.

H.R. Rep. No. 82-1923 at 6 (1952). Given the order of paragraphs as well as the transition, the final sentence, from which the Supreme Court draws in *Chakrabarty*, augments and reinforces the preceding paragraph—which addresses the final clause of § 101, not the preceding paragraphs that deal with the contours of patent eligible processes. Furthermore, the prefatory clause of that sentence appears to limit the dependent clause (“which may include anything under the sun that is made by man”) to the statutory classes of “machine” or “manufacture.” These categories plainly fall within the ambit of “useful Arts.” Note that the prefatory clause does not include the other statutory categories: “process” and “composition of matter.” Nor does this sentence call for maximal subject matter. Rather, it merely emphasizes the importance of meeting additional requirements for patentability.

In both cases applicants seek to patent a process the only novel feature of which is an algorithm embodied in a computer program. The primary difference between the two cases is in the manner in which the claims have been drafted: although *Flook*'s claims focused on the algorithm and recited only minor post-solution activity, the claims here recite in general terms the entire conventional rubber molding process.

Petitioner's Brief, *Diamond v. Diehr*, 6 No. 79-1112 (June 10, 1980) (summary of argument).

Writing for the majority, Justice Rehnquist explained that processes have been eligible for patent protection since the 1793 Act and referenced the statement from *Benson* that "[t]ransformation and reduction of an article 'to a different state or thing' is the clue to the patentability of a process claim that does not include particular machines." *Diamond v. Diehr*, 450 U.S. 175, 184 (1981) (quoting *Benson*, 409 U.S. at 70). The Court concluded that "a physical and chemical process for molding precision synthetic rubber products falls within the § 101 categories of possibly patentable subject matter." *Id.* Justice Rehnquist purported to distinguish *Benson* and *Flook* before proclaiming that "[o]ur earlier opinions lend support to our present conclusion that a claim drawn to subject matter otherwise statutory does not become non-statutory simply because it uses a mathematical formula, computer program, or digital computer." *Id.* at 187. The Court emphasized that process claims are properly analyzed

as a whole. It is inappropriate to dissect the claims into old and new elements and then to ignore the presence of the old elements in the analysis. This is particularly true in a process claim because a new combination of steps in a process may be patentable even though all the constituents of the combination were well known and in common use before the combination was made. The "novelty" of any element or steps in a process, or even of the process itself, is of no relevance in determining whether the subject matter of a claim falls within the § 101 categories of possibly patentable subject matter.

Id. at 188–89. In so doing, Justice Rehnquist swept away the requirement of *inventive* application. He reiterated, however, that "a mathematical formula as such" is not patentable nor is attempting to limit the use of a formula to a particular technological environment, citing *Benson* and *Flook*. *Id.* at 191. The touchstone for patentability of a process embodying a mathematical formula, according to the majority opinion, is significant postsolution activity—that is, "transforming or reducing an article to a different state or thing." *Id.* at 191–92.

Justice Stevens, joined by Justices Brennan, Marshall, and Blackmun, vehemently dissented, emphasizing that the majority eviscerated the *inventive* application doctrine. To the dissenters, if the inventor's "method is regarded as an 'algorithm' as that term was used" in *Benson* and *Flook*, "and if no other *inventive* concept is disclosed in the patent application," then the claim falls outside the scope of patentable processes under § 101. *Id.* at 213–14. Moreover, the dissenters contended that "the postsolution activity described in the *Flook* application was no less significant than the automatic opening of the curing mold involved in this case." *Id.* at 215.

14.3.1.2.4 The Rise of the Federal Circuit and Dismantling of Patentable Subject-Matter Limitations

Over the ensuing nearly three decades, the evolution of patent-eligibility doctrine shifted to the Court of Appeals for the Federal Circuit, established in 1982. Perhaps bearing out concerns that a national appellate patent tribunal would favor expansion of patent protection, the Federal Circuit gradually eroded patent-eligibility limitations. Building off of *Diehr*, the Federal Circuit gradually chipped away at the postsolution activity necessary to bring software-related claims within § 101. *See, e.g., In re Alappat*, 33 F.3d 1526 (Fed. Cir. 1994). Similarly, the Federal Circuit endorsed the USPTO's policy of patent eligibility of DNA molecules. *See Amgen, Inc. v. Chugai Pharm. Co.*, 927 F.2d 1200 (Fed. Cir. 1991). In a departure from prior jurisprudence, the Federal Circuit “[a]id [the] ill-conceived [business-method] exception to rest.” *State St. Bank & Tr. Co. v. Signature Fin. Grp., Inc.*, 149 F.3d 1368, 1375 (Fed. Cir. 1998). The Supreme Court declined to weigh in on these controversies.

The *State Street Bank* decision sent shockwaves through the financial community, sweeping away more than a century of jurisprudence holding that business methods were unpatentable. Financial institutions became concerned that their investment strategies, which were maintained as trade secrets and hence could not qualify as prior art, could be held to infringe later-developed patents. As a result, they sought legislation excluding business methods from the scope of patentable subject matter. Intellectual-property trade organizations, however, resisted any changes to § 101. As a compromise, Congress established the § 273 prior-user defense as a safe harbor for the financial community. *See* First Inventor Defense Act of 1999, Pub. L. 106-113, app. A, 113 Stat. 1501, 552, 555. The legislation did not take a position on the scope of patentable subject matter.

The Federal Circuit's loosening of patent-eligibility doctrines brought about a vast expansion in the range of patents being sought and granted. The USPTO shifted its position from skepticism about expansive patent eligibility to openness and even enthusiasm, resulting in a flood of software, DNA, and business-method patents. Entrepreneurs and venture capitalists came to see patenting as a valuable tool for developing (or at least claiming) Internet-related businesses. The late 1990s witnessed an unprecedented growth of start-up businesses based on speculative initial public offerings secured, in part, on patent portfolios.

The bursting of the Internet stock bubble in the early 2000s produced a vast shake-out, causing widespread bankruptcies and the auctioning and sale of Internet-related patents. This led to the emergence of patent assertion entities—patent-holding companies and nonpracticing entities seeking to monetize Internet-related patents. Lawsuits by patent-assertion entities produced a tidal wave of patent-eligibility challenges as well as calls by Silicon Valley companies, policy makers, and scholars for policy reform.

The Federal Circuit issued several decisions cautiously reinvigorating patent-eligibility limitations. *See, e.g., In re Nuijten*, 500 F.3d 1346 (Fed. Cir. 2007) (holding that a watermarked electromagnetic signal does not fall into any of the four categories of patent-eligible subject matter); *In re Comiskey*, 499 F.3d 1365 (Fed. Cir. 2007), *amended by* 554 F.3d 967 (Fed. Cir. 2009) (noting the “[t]he obligation to determine

what type of discovery is sought to be patented [so as to determine whether it is ‘the kind of “discoveries” that the statute was enacted to protect’] *must precede* the determination of whether that discovery is, in fact, new or obvious” (citing *Parker v. Flook*, 437 U.S. 584, 593 (1978) (emphasis added by Federal Circuit); and affirming rejection of a business-method patent under § 101 as merely relying on mental steps). Most notably, the Federal Circuit, sitting en banc, attempted to clarify the boundaries of patentable subject matter under § 101. *See In re Bilski*, 545 F.3d 943 (Fed. Cir. 2008) (en banc).

Bilski claimed a method of managing risk of commodity prices—a business method that could be implemented using a computer. *Id.* at 949. In an effort to harmonize the Supreme Court’s *Benson*, *Flook*, and *Diehr* precedents, the Federal Circuit devised the “machine-or-transformation” (“MoT”) test “to determine whether a process claim is tailored narrowly enough to encompass only a particular application of a fundamental principle rather than to pre-empt the principle itself.” *Id.* at 954. Under the MoT test, a claimed process is patent-eligible under § 101 if: “(1) it is tied to a particular machine or apparatus, or (2) it transforms a particular article into a different state or thing.” *Id.* The court concluded that the Bilski patent failed both prongs—it was not tied to a “particular” machine, and transformation of legal obligations or relationships, business risks, or other abstractions were not within the types of tangible changes eligible for patent protection—and it hence was unpatentable. *Id.* at 963–66.

14.3.1.2.5 The Supreme Court’s Revival of Subject-Matter Limitations

The Supreme opened a new chapter in patent-eligibility jurisprudence with its grant of review in the *Bilski* case. Many groups and individuals filed amicus briefs, with arguments ranging from the unpatentability of business methods as falling outside of the “useful arts” and hence beyond Congress’s legislative authority to a textual argument that § 101 encompasses “any” process. The Court’s ultimate decision in *Bilski* would prove anticlimactic and unilluminating. *See Bilski v. Kappos*, 561 U.S. 593 (2010); Peter S. Menell, *Forty Years of Wondering in the Wilderness and No Closer to the Promised Land: Bilski’s Superficial Textualism and the Missed Opportunity to Return Patent Law to Its Technology Mooring*, 63 *Stan. L. Rev.* 1289 (2011).

While affirming the Federal Circuit’s decision holding Bilski’s hedging patent application invalid, the Supreme Court rejected the MoT test as the *sole* test of patent eligibility of process claims. *Bilski*, 561 U.S. at 603. The Supreme Court characterized the MoT test as a “useful and important clue, an investigative tool, for determining whether some claimed inventions are processes under § 101,” but too rigid in view of the broad statutory definition in § 100(b) of “process.” *Id.* at 603–04. While recognizing the jurisprudentially developed exclusions for laws of nature, natural phenomena, and abstract ideas, the Court nonetheless warned that the judiciary does not have “*carte blanche* to impose other limitations that are inconsistent with the

text and the statute’s purpose and design.” *Id.* at 603.¹⁴ On similar grounds, the majority rejected the argument that business methods are categorically excluded from patent eligibility.¹⁵ *Id.* at 606–08.

The majority ruled that Bilski’s broad independent claim to hedging was “an unpatentable abstract idea, just like the algorithms at issue in *Benson* and *Flook*. Allowing petitioners to patent risk hedging would pre-empt use of this approach in all fields, and would effectively grant a monopoly over an abstract idea.” *Id.* at 611–12. The Court further rejected Bilski’s narrower dependent claims as unpatentable by reference to *Flook*, which “established that limiting an abstract idea to one field of use or adding token postsolution components did not make the concept patentable.” *Id.*

Justice Stevens, joined by Justices Ginsburg, Breyer, and Sotomayor, filed an extensive opinion concurring in the judgment, but contending that the Patent Act and jurisprudence have long categorically excluded business methods from patent eligibility. *Id.* at 613.

In contrast to the cautious ruling in *Bilski*, the Supreme Court’s next patentable subject-matter case, *Mayo Collaborative Servs. v. Prometheus Laboratories, Inc.*, 132 S. Ct. 1289 (2012), strongly reinvigorated patent-eligibility limitations. The patentee claimed a process for administering a particular drug, determining the resulting level of the drug in the patient’s blood, and setting forth ranges for decreasing, maintaining, or increasing the dosage of the drug. *Id.* at 1295. Writing for a unanimous Court, Justice Breyer held the patent invalid on the ground that the claimed invention does little more than apply a law of nature. *Id.* at 1294.

The decision revives the inventive application framework set forth in *Flook*, a test that had been supplanted by *Diehr*. In so doing, the Court based the decision, as it did in *Flook*, on a misreading of *Neilson v. Harford*, stating that “the claimed process [in *Neilson*] included not only a law of nature but also several unconventional

14. The Supreme Court stressed that “[i]n disapproving an exclusive machine-or-transformation test, we by no means foreclose the Federal Circuit’s development of other limiting criteria that further the purposes of the Patent Act and are not inconsistent with its text.” *Id.* at 612–13. The Court emphasized, however, that “nothing in today’s opinion should be read as endorsing interpretations of § 101 that the Court of Appeals for the Federal Circuit has used in the past.” *Id.* at 612.

15. It reinforced this textual focus with the inference that Congress would not have enacted the § 273 prior-user defense if it did not consider business methods patentable. *Id.* at 607. A more plausible inference is that Congress side-stepped the scope of § 101 and created the prior-user defense as a way to defuse a politically divisive question quickly. Congress placed § 273 in Part III of Title 35, which addresses enforcement rights, not the conditions under which a patent may be obtained. Furthermore, in defining the term “method” for purposes of the prior-user defense, Congress avoided altering the definitions governing patentable subject matter in § 100. See 35 U.S.C. § 100(a) (providing definitions of terms “[w]hen used in this title”). Instead, Congress included a definition of “method” in § 273(a), “[f]or purposes of *this* section,” which deals only with the limited defense. *Id.* (emphasis added).

steps (such as inserting the receptacle, applying heat to the receptacle externally, and blowing the air into the furnace) that confined the claims to a particular, useful application of the principle.” See *id.* at 1300. To the contrary, the *Neilson* case upheld the broad claim to an application of a law of nature notwithstanding that the application of the natural law was conventional. See §§ 14.3.1.2.1, 14.3.1.2.3. Beyond this misapprehension, the Court glossed over the undeniable tension between *Flook* and *Diehr*.

The Supreme Court turned to the patent eligibility of genetic sequences in the following term. The patentee in *Association for Molecular Pathology v. Myriad Genetics, Inc.*, 133 S. Ct. 2107 (2013), had obtained patents on claims to isolated deoxyribonucleic acid (DNA) sequences associated with predisposition to breast cancers and ovarian cancers and for diagnostic methods of identifying mutations in those DNA sequences. *Id.* at 2112–13. The patentee also obtained claims on complementary DNA (cDNA) compositions derived from the naturally occurring DNA molecules.¹⁶ *Id.* Writing for a unanimous Supreme Court, Justice Thomas held that isolated DNA involving a naturally occurring genomic DNA segment was unpatentable as a natural phenomenon, but that cDNA derived from such genomic DNA was patentable due to human intervention.¹⁷ *Id.* at 2116–19.

The Court did not reach step two of the *Mayo/Alice* test on the ground that cDNA was not naturally occurring and therefore not drawn to a judicial exception. cDNA, however, contains the same genetic information as naturally occurring mRNA and Myriad did not create or alter this information. Moreover, the act of reverse-transcribing natural mRNA into cDNA was known, routine, and conventional when the Myriad patents were filed in 1994. See Jeffrey A. Lefstin, *The Three Faces of Prometheus: A Post-Alice Jurisprudence of Abstractions*, 16 N.C. J.L. & Tech. 647, 678–79 (2015).

The Supreme Court took another patent-eligibility case the following term. In *Alice Corp. Pty. Ltd. v. CLS Bank International*, 134 S. Ct. 2347 (2014), the Supreme Court addressed patent claims reminiscent of those at issue in *Bilski*. The patentee had obtained patents for mitigating settlement risk in financial transactions using a computer system as a third-party intermediary. The en banc Federal Circuit was

16. The PTO and the Federal Circuit considered DNA sequences derived from living organisms to be patentable so long as the patentee could establish credible utility. See, e.g., *In re Fisher*, 421 F.3d 1365 (Fed. Cir. 2005). The legal basis for this view traces back a century to a Judge Learned Hand decision upholding a patent on a purified form of adrenaline (isolating the extract in the form of a chemical base) as distinct from the natural substance, *Parke-Davis & Co. v. H.K. Mulford & Co.*, 189 F. 95 (S.D.N.Y. 1911), *aff'd*, 196 F. 496 (2d Cir. 1912) (reasoning that the purified form of the naturally occurring substance “became for every practical purpose a new thing commercially and therapeutically”).

17. DNA sequences are composed of regions that code for proteins (exons) and regions that do not (introns). cDNA molecules are synthesized by removing introns. cDNA is most often synthesized from mature (fully spliced) messenger RNA (mRNA) using the enzyme reverse transcriptase. See Complementary DNA, Wikipedia <https://en.wikipedia.org/wiki/Complementary_DNA>.

deeply divided on the interpretation of *Bilski* and *Mayo*. Writing for a unanimous Supreme Court, Justice Thomas reaffirmed the inventive application approach revived in *Mayo*: “We have described step two of this analysis as a search for an “inventive concept”—i.e., an element or combination of elements that is “sufficient to ensure that the patent in practice amounts to significantly more than a patent upon the [ineligible concept] itself.”” *Id.* at 2355. Applying this framework, the Court concluded that the representative method claim does no more than implement the abstract idea of intermediated settlement on a generic computer and that the system and media claims add nothing of substance to the underlying abstract idea. *Id.* at 2355–60.¹⁸

14.3.1.3 Patent-Eligibility Conundrums

Notwithstanding the Supreme Court’s renewed attention to patent eligibility, the *Bilski*, *Mayo*, *Myriad*, and *Alice* decisions provide relatively little guidance on how to determine whether a claim contains a patent-ineligible natural law, physical phenomenon, or abstract idea and, if so, whether there is a sufficient inventive concept or inventive application to bring the claim within § 101 eligibility. The Federal Circuit’s early applications of this regime reinforce the “know it when you see it” quality of the Supreme Court’s two-step test. *See, e.g., DDR Holdings, LLC v. Hotels.com, L.P.*, 773 F.3d 1245 (Fed. Cir. 2014) (emphasizing under step 1 that the claim is “rooted in the computer technology” and hence not abstract; and basing step 2 analysis on a bald assertion that the claimed invention is “not merely the routine or conventional use of the Internet” without discussion of prior art); *Ultramercial, Inc. v. Hulu, LLC*, 772 F.3d 709, 715 (2014) (noting that “[a]s the Court stated in *Alice*, “[a]t some level, “all inventions . . . embody, use, reflect, rest upon, or apply laws of nature, natural phenomena, or abstract ideas”); *Alice*, 134 S. Ct. at 2354 (quoting *Mayo*, 132 S. Ct. at 1293). We acknowledge this reality, and we do not purport to state that all claims in all software-based patents will necessarily be directed to an abstract idea. Future cases may turn out differently.”). Several district court decisions have grappled with these issues. *See, e.g., Ameritox Ltd. v. Millennium Health, LLC*, 88 F. Supp. 3d 885 (W.D. Wisc. 2015); *Cal. Inst. of Tech. v. Hughes Commc’ns, Inc.*, 59 F. Supp. 3d 974 (C.D. Cal. 2014); *Cogent Med., Inc. v. Elsevier Inc.*, 70 F. Supp. 3d 1058 (N.D. Cal. 2014).

Among the issues that remain to be resolved are: (1) to what extent does § 101 eligibility turn on subsidiary factual determinations (e.g., whether an application of a natural law is routine or conventional) and claim construction; (2) at what stage of litigation should district courts address § 101 eligibility; and (3) what is the continuing relevance of *Diehr* and can it be reconciled with *Flook*, *Mayo*, *Myriad*, and *Alice*. What is clear is that we are at the beginning of a new patent-eligibility era in which lower courts will need to develop case-management techniques for assessing whether

18. Echoing Justice Stevens’ concurrence in *Bilski*, Justice Sotomayor, joined by Justices Ginsburg and Breyer, concurred in the holding based on the view that business methods do not qualify as a “process” under § 101. *Id.* at 2360.

patent claims involving natural laws, physical phenomena, and abstract ideas can surmount the § 101 inventive application hurdle and when and on what basis that determination should be made.

14.3.1.4 Subject Matter Expressly Excluded by Statute

For the first time in U.S. history, the AIA introduced two statutory exclusions to patentable subject matter, effective September 16, 2011.

14.3.1.4.1 Tax Strategies

Strategies for “reducing, avoiding, or deferring tax liability” are deemed to be within the prior art. This does not apply to claims directed to preparing tax returns or inventions “used solely for financial management” to the extent that they are severable from any tax strategy. AIA § 14. This provision is effective September 16, 2011, and applies to applications pending or filed on or after that date.

14.3.1.4.2 Human Organisms

Claims “directed to or encompassing a human organism” are barred. This provision is effective September 16, 2011, and applies to applications pending or filed on or after that date. AIA § 33.

14.3.2 Utility (§ 101)

Section 101 requires that an invention be “useful” to be patentable. Whether an invention meets the utility requirement is decided from the perspective of a person having ordinary skill in the art. Because most inventions have a clear utility (and “inventions” of questionable utility will typically be flagged during prosecution), the utility requirement rarely arises in litigation. Utility can arise where a claimed invention does not work for its intended purpose. The two areas in which utility tends to arise in litigation with some frequency are in the fields of chemistry and biotechnology, where inventors seek to obtain patents on compositions of matter before they have conclusive evidence of their utility.

The Supreme Court provided the framework for addressing this question in *Brenner v. Manson*, 383 U.S. 519 (1966). The patentee sought protection for an adjacent homologue¹⁹ of a steroid demonstrated to have tumor-inhibiting effects in mice. *Id.* at 520–22. The inventor had yet to establish such properties for the compound at issue and there was high unpredictability of compounds in the relevant field of chemistry. *Id.* at 532. In rejecting the patent on the basis of lack of proven utility, the Supreme Court commented that

19. A homologue is a member of a chemical series whose compounds differ structurally from each other only by a repeating unit, such as a methylene bridge—CH₂—or a peptide residue. Homologues that are “adjacent” differ from each other by just one of the repeating unit.

the basic quid pro quo contemplated by the Constitution and the Congress for granting a patent monopoly is the benefit derived by the public from an invention with substantial utility. Unless and until a process is refined and developed to this point—where specific benefit exists in currently available form—there is insufficient justification for permitting an applicant to engross what may prove to be a broad field.

Id. at 534–35. The Court required patentees to establish credible, specific, and substantial utility.

Thus, chemical compounds are not rendered useful merely because they have analogues that are useful. Utility in such cases will depend on the degree of predictability within the art and structural similarity between the claimed compound and others known to have useful properties. Clinical data is not generally required to show the utility of chemical compounds.

An invention must be useful for something more than further research on the product of the invention. If an invented chemical compound, for instance, is being studied extensively as a possible cancer treatment, but no potential to treat cancer has actually been shown, the chemical does not meet the utility requirement, nor is a process to make that chemical useful. The product of the process must have utility for the process to have utility. “Until the process claim has been reduced to production of a product shown to be useful, the metes and bounds of the monopoly are not capable of precise delineation. . . . Such a patent may confer power to block whole areas of scientific development, without compensating benefit to the public.” *Id.* at 534. Additionally, an invention must have proven usefulness beyond use as a chemical probe where the results of such a probe are unknown or where the results of that probe are known to lack utility. *In re Fisher*, 421 F.3d 1365, 1371 (Fed. Cir. 2005).

Note, however, that an invention does not need to be better than other technology, nor must it show commercial success to possess substantial utility. Nor do courts judge the morality of a claimed invention in assessing utility. *See Juicy Whip, Inc. v. Orange Bang, Inc.*, 292 F.3d 728 (Fed. Cir. 2002).

14.3.3 Disclosure (§ 112)

Paragraph 1 of § 112 sets forth the disclosure requirement:

The specification shall contain a *written description* of the invention, and of the manner and process of making and using it, in such full, clear, concise, and exact terms as *to enable* any person skilled in the art to which it pertains, or with which it is most nearly connected, to make and use the same, and shall set forth the *best mode* contemplated by the inventor of carrying out his invention (emphases added).

As interpreted by the Federal Circuit, this provision comprises three distinct requirements: (1) written description—that the specification conveys to a person having ordinary skill in the art that the inventor “possessed” the claimed invention as of the time of filing the application; (2) enablement—that the specification enables a person having ordinary skill in the art to make and use the invention; and (3) best mode—that the specification reveals the best mode of which the inventor is aware of making and using the invention.

14.3.3.1 Written Description

The written description requirement serves to “prevent an applicant from later asserting that he invented that which he did not.” *Amgen Inc. v. Hoechst Marion Roussel, Inc.*, 314 F.3d 1313, 1330 (Fed. Cir. 2003). The patentee must “convey with reasonable clarity to those skilled in the art that, as of the filing date sought, he or she was in possession of the invention.” *Vas-Cath Inc. v. Mahurkar*, 935 F.2d 1555, 1563–64 (Fed. Cir. 1991). Having “possession of the invention” means that the patentee invented what is claimed. *LizardTech, Inc. v. Earth Res. Mapping, Inc.*, 424 F.3d 1336, 1345 (Fed. Cir. 2005).

Although written description and enablement issues often rise and fall together, the written description requirement is separate and distinct from enablement. *Ariad Pharm., Inc. v. Eli Lilly & Co.*, 598 F.3d 1336, 1351 (Fed. Cir. 2010) (en banc) (“Since its inception, this court has consistently held that § 112, first paragraph, contains a written description requirement separate from enablement.”). As a result, an invention may be described without being enabled, and vice versa. The written description requirement “plays a vital role in curtailing claims that do not require undue experimentation to make and use, and thus satisfy enablement, but that have not been invented, and thus cannot be described.” *Id.* at 1352.

Compliance with the written description requirement is “an objective inquiry into the four corners of the specification from the perspective of a person of ordinary skill in the art.” *Ariad*, 598 F.3d at 1351. The adequacy of the written description is a question of fact, and is highly dependent on the context; the nature and scope of the claims; the complexity and predictability of the relevant technology; the extent and content of the prior art; and the maturity of the science or technology. *Id.*

The patentee need not follow any specific form of disclosure in providing a written description of the invention. *In re Alton*, 76 F.3d 1168, 1172 (Fed. Cir. 1996). However, a description that merely renders the invention obvious is insufficient. See *Goeddel v. Sugano*, 617 F.3d 1350, 1356 (Fed. Cir. 2010) (“The question is not whether one skilled in this field of science might have been able to produce [the claimed subject matter] by building upon the teachings of the [prior art], but rather whether that application ‘convey[ed] to those skilled in the art that the inventor had possession of the claimed subject matter as of the filing date.’”) (quoting *Ariad*, 598 F.3d at 1351). In some cases, the drawings alone may be adequate to satisfy the written description requirement. *Vas-Cath*, 935 F.2d at 1564.

14.3.3.1.1 Policing Continuation Practice

The Federal Circuit has applied the written description requirement to police efforts by patentees to expand the scope of their patent beyond what they had initially contemplated as their invention. Some patentees will keep continuation and/or continuation-in-part applications pending for several years in order to pursue additional claims that capture their rivals’ products introduced into the marketplace during the pendency of those applications. If the subject matter of the additional claims does not have written-description support in the specification of a prior related application from which priority is accorded, the additional claims will be invalid (even if the

specification enables one skilled in the art to make and use the claimed subject matter). See *Centocor Ortho Biotech, Inc. v. Abbott Labs.*, 636 F.3d 1341 (Fed. Cir. 2011) (claims added eight years after priority date lacked support in written description); see also § 132(a).

14.3.3.1.2 Biotechnology Patents

Beginning in the mid-1990s, the Federal Circuit required that biotechnology patents disclose specific gene sequences in the application even when the functional properties of the gene (such as the protein it codes for) were already known. See *Regents of the Univ. of Cal. v. Eli Lilly & Co.*, 119 F.3d 1559 (Fed. Cir. 1997); *Fiers v. Revel*, 984 F.2d 1164, 1170–71 (Fed. Cir. 1993). Some have characterized these cases as erecting a “super-enablement” standard for biotechnology inventions. See Janice M. Mueller, *The Evolving Application of the Written Description to Biotechnological Inventions*, 13 Berkeley Tech. L.J. 615 (1998). More recently, the Federal Circuit has eased this standard by allowing patentees to satisfy the written description requirement by placing several versions of the claimed nucleotide sequences in a public depository. See *Enzo Biochem, Inc. v. Gen-Probe, Inc.*, 323 F.3d 956 (Fed. Cir. 2002); see also *Capon v. Eshhar*, 418 F.3d 1349 (Fed. Cir. 2005) (noting that the requirements for “written description” evolve with the fields of invention).

Demonstrating adequate written-description support for a genus is “a problem that is particularly acute in the biological arts.” *Ariad Pharm., Inc. v. Eli Lilly & Co.*, 598 F.3d 1336, 1352–53 (Fed. Cir. 2010) (en banc). “[A] sufficient description of a genus . . . requires the disclosure of either a representative number of species falling within the scope of the genus or structural features common to the members of the genus so that one of skill in the art can ‘visualize or recognize’ the members of the genus.” *Id.* at 1350 (citation omitted). “[M]erely drawing a fence around the outer limits of a purported genus is not an adequate substitute for describing a variety of materials constituting the genus and showing that one has invented a genus and not just a species.” *Id.* (“The claims here recite methods encompassing a genus of materials achieving a stated useful result, i.e., reducing NF-[K]B binding to NF-[K]B recognition sites in response to external influences. But the specification does not disclose a variety of species that accomplish the result.”).

14.3.3.2 Enablement

To satisfy the enablement requirement, the specification must set forth the “manner and process of making and using [the invention], in such full, clear, concise and exact terms as to enable any person skilled in the art to which it pertains, or with which it is most nearly connected, to make and use the same.” § 112, ¶ 1. The purpose of the enablement provision is to ensure that “the public knowledge is enriched by the patent specification to a degree at least commensurate with the scope of the claims. The scope of the claims must be less than or equal to the scope of the enablement.” *Nat’l Recovery Techs., Inc. v. Magnetic Separation Sys., Inc.*, 166 F.3d 1190,

1195–96 (Fed. Cir. 1999). Enablement is determined as of the effective filing date of the patent.²⁰ See *Plant Genetic Sys., N.V. v. DeKalb Genetics Corp.*, 315 F.3d 1335, 1339 (Fed. Cir. 2003). Accordingly, after-arising technology should not be considered in the enablement inquiry. Enablement is a question of law based on underlying findings of fact. See *In re Vaeck*, 947 F.2d 488, 495 (Fed. Cir. 1991).

Enablement is often a matter of degree. Courts evaluate compliance with the enablement requirement by considering whether the specification teaches those skilled in the art to make and use the invention without “undue experimentation.” *In re Vaeck*, 947 F.2d at 495 (quoting *In re Wands*, 858 F.2d 731, 737 (Fed. Cir. 1988)). As the Federal Circuit has noted, “[t]hat some experimentation may be required is not fatal; the issue is whether the amount of experimentation required is ‘undue.’” *Id.* In determining what constitutes undue experimentation, courts apply a standard of reasonableness, taking into account the nature of the invention and the state of the art. Factors to be considered in making such a determination include:

- (1) The quantity of experimentation necessary,
- (2) The amount of direction or guidance presented,
- (3) The presence or absence of working examples,
- (4) The nature of the invention,
- (5) The state of the prior art,
- (6) The relative skill of those in the art,
- (7) The predictability or unpredictability of the art, and
- (8) The breadth of the claims.

In re Wands, 858 F.2d at 737. These factors are “illustrative, not mandatory.” *Amgen, Inc. v. Chugai Pharm. Co.*, 927 F.2d 1200, 1213 (Fed. Cir. 1991). It is not necessary that the patent specification teach what is well known in the art. See *Hybritech Inc. v. Monoclonal Antibodies, Inc.*, 802 F.2d 1367, 1384 (Fed. Cir. 1986).

A broad claim construction can result in invalidity due to lack of enablement. When two embodiments are “distinctly different,” each must be separately enabled. See *Auto. Tech. Int’l v. BMW*, 501 F.3d 1274 (Fed. Cir. 2007) (comparing two columns and five figures of specification for a mechanical sensor with one short paragraph and one figure for an electronic sensor, with uncontradicted expert testimony indicating undue experimentation was required to enable the electronic sensor).

Furthermore, courts have interpreted the “how to use” prong of § 112 as incorporating the utility requirement of § 101. *Rasmusson v. Smithkline Beecham Corp.*, 413 F.3d 1318, 1322–23 (Fed. Cir. 2005). Accordingly, an applicant’s failure to disclose how to use an invention may be rejected under either § 112 for lack of enablement or § 101 for lack of utility. *Id.* at 1323.

20. The “effective filing date” of an application is the earlier of the actual filing date or the filing date of an application from which priority is accorded.

14.3.3.3 Best Mode

For proceedings commenced on or after September 16, 2011, the AIA eliminates the failure to disclose the best mode as a basis for invalidating the patent during litigation. AIA § 15. This does not affect USPTO examination, such that the USPTO may still reject an application for failure to disclose the best mode.

The best mode requirement of § 112(a) demands that the specification set forth “the best mode contemplated by the inventor of carrying out his invention.” This requirement restrains inventors from applying for patents while concealing known preferred embodiments of their inventions from the public. See *Teleflex, Inc. v. Ficosa N. Am. Corp.*, 299 F.3d 1313, 1330 (Fed. Cir. 2002). The Federal Circuit has interpreted best mode to require “an inventor to disclose the best mode contemplated by him, as of the time he executes the application, of carrying out the invention” defined by the claims. See *Bayer AG v. Schein Pharm., Inc.*, 301 F.3d 1306, 1314–15 (Fed. Cir. 2002) (quoting *In re Gay*, 309 F.2d 769, 772 (C.C.P.A. 1962)).

Compliance with the best mode requirement is a question of fact. *Bayer*, 301 F.3d at 1312. The test for compliance involves a two-prong inquiry: (1) did the inventor possess a best mode for practicing the invention at the time of filing the application; and (2) if the inventor possessed a best mode, is his disclosure adequate to enable a person having ordinary skill in the art to practice the best mode of the invention. See *Chemcast Corp. v. Arco Indus. Corp.*, 913 F.2d 923, 927–28 (Fed. Cir. 1990). While the first prong is subjective and examines the inventor’s state of mind at the time of filing, the second prong is objective and focuses on the scope of the claimed invention and the level of skill in the art. *Eli Lilly & Co. v. Barr Labs., Inc.*, 251 F.3d 955, 963 (Fed. Cir. 2001). Best mode violations are found where there is either a “failure to disclose a preferred embodiment, or else failure to disclose a preference that materially affected making or using the invention.” *Bayer*, 301 F.3d at 1316.

An inventor is typically not required to update the best mode disclosure based on findings made subsequent to the filing date, even if his or her patent application is still pending. Regarding continuation applications, the inventor need not update the best mode disclosure if the material in a continuation application is “common subject matter” with that of the original application. See *Transco v. Performance Contracting, Inc.*, 38 F.3d 551 (Fed. Cir. 1994). An inventor need only update the best mode in a continuation application if the claim feature associated with that best mode first appeared or first received adequate written description in that later filing.

14.3.3.4 Claim Definiteness

Section 112(b), formerly § 112, ¶ 2, provides that “[t]he specification shall conclude with one or more claims particularly pointing out and distinctly claiming the subject matter which the applicant regards as his invention.” This requirement ensures that the patentee adequately notify the public of the scope of his or her invention. “A patent is invalid for indefiniteness if its claims, read in light of the specification delineating the patent, and the prosecution history, fail to inform, with reasonable certainty, those skilled in the art about the scope of the invention.” *Nautilus v.*

Biosig Instruments, Inc., 134 S. Ct. 2120, 2123 (2014). The definiteness standard recognizes that “absolute precision is unattainable.” *Id.* It “must take into account the inherent limitations of language” and allow a “modicum of uncertainty” so as to provide appropriate incentives for innovation. *Id.* at 2128. For example, terms of degree such as “substantially,” “about,” or “closely approximate” do not necessarily render the claim indefinite, so long as the term “provide[s] enough certainty to one of skill in the art when read in the context of the invention.” *Interval Licensing LLC v. AOL, Inc.*, 766 F.3d 1364, 1370 (Fed. Cir. 2014). Nonetheless, the Supreme Court recognized that a patent must be precise enough to afford public notice of claim scope, otherwise there would be a “zone of uncertainty which enterprise and experimentation may enter only at the risk of infringement claims.” *Nautilus*, 134 S. Ct. at 2128.

14.3.4 Novelty and Statutory Bars (§ 102)

With the enactment of the AIA, the regime under which patents are awarded in the U.S. changed on March 16, 2013, from a first-to-invent system (i.e., awarding a patent to the inventor having the earliest date of invention) to a first-to-file system (i.e., awarding a patent to the inventor who files his application first). AIA § 3. The change from a first-to-invent system to a first-to-file system is not retroactive. As a result, the first-to-invent regime will coexist in parallel with the first-to-file regime for at least the next couple of decades.

To establish a first-to-file system, § 102 was completely rewritten under the AIA. The amended version of § 102 will apply to any application having at least one claim with an effective filing date on or after March 16, 2013. The version of § 102 that was in effect under the first-to-invent regime prior to the enactment of the AIA will apply to applications in which all claims have effective filing dates before March 16, 2013. Accordingly, the discussion of novelty requirements under § 102 in this section will be presented separately for each regime: § 14.3.4.1 covers the first-to-invent regime, while § 14.3.4.2 covers the first-to-file regime.

14.3.4.1 The First-to-Invent Regime

For patent applications in which all claims have effective filing dates prior to March 16, 2013, the novelty requirement is governed by the pre-AIA version of § 102. Accordingly, all references to § 102 in this subsection (§ 14.3.4.1), will refer to the pre-AIA version.

Section 102 sets forth two sets of novelty requirements for a patent to issue: (1) that the inventor was the first to invent (§ 102(a), (e), (f), and (g)); and (2) that the inventor filed their application in a timely manner (§ 102 (b), (c), and (d)).

The first set of requirements, referred to as the anticipation or lack of novelty bars, seeks to ensure that a patent issues only to the first inventor. This goal is accomplished by using the applicant’s date of invention as the relevant baseline for analysis. Prior art containing all elements of the claimed invention that became publicly available (or filed as part of a patent application or known, but not abandoned, suppressed, or concealed) will anticipate, and thereby defeat, the patent claim. By

contrast, the second set of requirements, known as statutory bars, and related timely filing provisions promote prompt disclosure by requiring that the patentee file an application within one year of various triggering events.

Whether a reference anticipates the applicant's invention is a question of fact. See *Elan Pharm., Inc. v. Mayo Found. for Med. Educ. and Research*, 346 F.3d 1051, 1054 (Fed. Cir. 2003). A finding of anticipation requires the reference to contain each and every limitation of the claimed invention either expressly or inherently.²¹ If even one limitation of the claimed invention is missing from the prior art reference, § 102 does not invalidate the claim—although the claim may still be vulnerable under the nonobviousness requirement. See § 14.3.5.

If a single reference discloses a species of a claimed genus,²² a claim to the entire genus is anticipated. See *Eli Lilly & Co. v. Barr Labs., Inc.*, 222 F.3d 973, 987 (Fed. Cir. 2000); *Titanium Metals Corp. v. Banner*, 778 F.2d 775 (Fed. Cir. 1985). The opposite is not always true; the disclosure of a genus in a single prior art reference does not necessarily anticipate a claimed species that is a member of that genus. See *Atofina v. Great Lakes Chem. Co.*, 441 F.3d 991, 999 (Fed. Cir. 2006).

14.3.4.1.1 First to Invent—§ 102(a)

Section 102(a) precludes patentability where the “invention was known or used by others in this country, or patented or described in a printed publication in this or a foreign country,” before the applicant's date of invention. Note the geographic limitations on the prior art covered by § 102(a): whereas knowledge or use must occur

21. A finding of anticipation requires that a prior art reference enable a person having ordinary skill in the art to make or use the claimed invention. See *Impax Labs., Inc. v. Aventis Pharm. Inc.*, 468 F.3d 1366 (Fed. Cir. 2006). This “enablement” standard is not as strict as that applied under § 112. Unlike that enablement requirement, an enabling reference under § 102 need not disclose utility, only the claimed invention's limitations. *Id.* A claim is anticipated if each element of the claim is found, either expressly or inherently, in a single prior art reference. See *Verdegaal Bros., Inc. v. Union Oil Co. of Cal.*, 814 F.2d 628, 631 (Fed. Cir. 1987). There are, however, several exceptions to the inherency doctrine. In *Tilghman v. Proctor*, 102 U.S. 707 (1880), the Supreme Court declined to invalidate a patent based on a prior art machine (a steam engine) that might have accidentally and unwittingly produced a claimed fatty acid that proved useful as a cleansing substance. Nor does mere probabilistic inherency, see *Continental Can Co. USA v. Monsanto Co.*, 948 F.2d 1264, 1269 (Fed. Cir. 1991), nor the presence of an unrecognized de minimis quantity of a claimed substance in the prior art, see *In re Seaborg*, 328 F.2d 996 (C.C.P.A. 1964), anticipate later patent applications. See also *Eibel Process Co. v. Minn. & Ontario Paper Co.*, 261 U.S. 45 (1923). The Federal Circuit has, however, interpreted these exceptions and qualifications to the inherency rule narrowly. See *Schering Corp. v. Geneva Pharm., Inc.*, 339 F.3d 1373, 1377 (Fed. Cir. 2003) (observing that “[c]ases dealing with ‘accidental, unwitting, and unappreciated’ anticipation . . . do not show that inherency requires recognition”).

22. A genus is a category made up of multiple species that share a common characteristic. Chemical and biotechnology inventions are often claimed using genus and species formats.

in the United States to bar patentability, a patent or printed publication from anywhere in the world can invalidate a patent. The courts have developed nuanced interpretations of § 102(a), particularly the phrases “known or used” and “printed publication.”

14.3.4.1.1.1 “Known or Used”

Knowledge or use must have been available to the public to qualify as prior art under § 102. See *Woodland Tr. v. Flowertree Nursery, Inc.*, 148 F.3d 1368, 1370 (Fed. Cir. 1998). Courts generally balance several factors—the number and credibility of observers, the intent of the discloser (i.e., whether the inventor sought to keep the information secret), the number of disclosures, and the extent to which the observers understood the invention—in determining whether a disclosure or use was “public.” The evidence that knowledge or use was public is judged by the clear-and-convincing standard. In addition, “[t]he nonsecret use of a claimed process in the usual course of producing articles for commercial purposes is a public use.” *W.L. Gore & Assocs., Inc. v. Garlock, Inc.*, 721 F.2d 1540, 1548 (Fed. Cir. 1983). Secret knowledge or use (including classified government research and articles under submission to journals) does not qualify for purposes of § 102(a). The effective date of a knowledge or use reference is the day on which it was presented to the public. Because it is aimed at determining whether anyone preempted the patentee, § 102(a) does not treat knowledge or use by the applicants themselves as a reference; it only refers to knowledge or use “by others.”

14.3.4.1.1.2 Printed Publication

A printed publication has been interpreted to mean a reference that is “sufficiently accessible to the public interested in the art.” See *Constant v. Advanced Micro-Devices, Inc.*, 848 F.2d 1560, 1568 (Fed. Cir. 1988). Accordingly, dissemination and public accessibility are the determinative factors regarding whether a reference is “published.” “Accessibility goes to the issue of whether interested members of the relevant public could obtain the information if they wanted to. If accessibility is proved, there is no requirement to show that particular members of the public actually received the information.” *Id.* at 1569. Whether a reference qualifies as a printed publication under § 102 is a question of law based on underlying factual determinations. See *Cooper Cameron Corp. v. Kvaerner Oilfield Prods., Inc.*, 291 F.3d 1317, 1321 (Fed. Cir. 2002).

The Federal Circuit has construed sufficient accessibility broadly, finding a single thesis cataloged (by subject matter) in a German university library accessible to those interested in the art exercising reasonable diligence constituted “sufficient accessibility” to bar patentability under § 102(b). *In re Hall*, 781 F.2d 897, 900 (Fed. Cir. 1986). Even a temporarily displayed reference that was neither distributed nor indexed may be sufficiently accessible to constitute a printed publication. See *In re Klopfenstein*, 380 F.3d 1345, 1350 (Fed. Cir. 2004). Relevant factors to analyze include:

- (1) the length of time the display was exhibited,

- (2) the expertise of the target audience,
- (3) the existence (or lack thereof) of reasonable expectations that the material displayed would not be copied, and
- (4) the simplicity or ease with which the material displayed could have been copied.

Id. Whether “printed publication” encompasses new technologies such as websites remains to be conclusively decided, but the Federal Circuit has noted that the phrase “has been interpreted to give effect to ongoing advances in the technologies of data storage, retrieval, and dissemination.” *In re Hall*, 781 F.2d at 898.

14.3.4.1.2 Novelty—First to Invent—§ 102(g)

Section 102(g) addresses situations where two or more researchers independently discover the same invention, with the goal of granting a patent only to the first person to “invent” who does not abandon, suppress, or conceal the invention from the public. The somewhat opaque statutory provision provides that a patent shall issue unless:

- (1) during the course of an interference conducted under section 135 or section 291, another inventor involved therein establishes, to the extent permitted in section 104, that before such person’s invention thereof the invention was made by such other inventor and not abandoned, suppressed, or concealed, or (2) before such person’s invention thereof, the invention was made in this country by another inventor who had not abandoned, suppressed, or concealed it. In determining priority of invention under this subsection, there shall be considered not only the respective dates of conception and reduction to practice of the invention, but also the reasonable diligence of one who was first to conceive and last to reduce to practice, from a time prior to conception by the other.

The following schematic representation of § 102(g) shows how courts interpret this language:

- (1) during the course of an interference conducted under section 135 or section 291, another inventor involved therein establishes, to the extent permitted in section 104, that
 - a. before such person’s invention thereof the invention was
 - b. made by such other inventor and
 - c. not abandoned, suppressed, or concealed, or
- (2) [in the context of an invalidity defense to patent infringement]
 - a. before such person’s invention thereof, the invention was
 - b. made in this country by another inventor who
 - c. had not abandoned, suppressed, or concealed it.
- (3) In determining priority of invention [under either branch] of this subsection, there shall be considered not only
 - a. the respective dates of conception and reduction to practice of the invention, but also

- b. the reasonable diligence of one who was first to conceive and last to reduce to practice, from a time prior to conception by the other.

Subsection (1) deals with interferences, proceedings ordinarily conducted within the Patent Office (and only rarely in federal district court) when multiple inventors simultaneously claim the same invention. Subsection (2) is the more relevant provision for district courts. Defendants in infringement proceedings typically scour the field of technology to identify evidence that someone other than the patentee invented the claimed invention prior to the patentee's date of invention. Such evidence invalidates the issued patent claim if the invention was made in the United States before the patentee's date of invention and the first inventor did not abandon, suppress, or conceal the invention.

To make these principles operational, we need precise definitions of the following terms: (i) "conception," (ii) "reduction to practice," (iii) "reasonable diligence," and (iv) "abandoned, suppressed, or concealed."

14.3.4.1.2.1 Conception

A conception of the claimed invention is "the complete performance of the mental part of the inventive art," a "definite and permanent idea of the complete and operative invention." See *Townsend v. Smith*, 36 F.2d 292, 295 (C.C.P.A. 1929). It represents the idea of the invention and does not require tests, models, or prototypes. Nonetheless, it must contain all limitations of the claimed invention as it is thereafter reduced to practice. To deter fraud, the law requires corroboration of any inventor testimony regarding conception, reduction to practice, or diligence. See *Mahurkar v. C.R. Bard Inc.*, 79 F.3d 1572, 1577–78 (Fed. Cir. 1996). Often this corroborating evidence takes the form of contemporaneous witnessed notebooks or records by someone skilled in the art. See, e.g., *Hahn v. Wong*, 892 F.2d 1028, 1032–33 (Fed. Cir. 1989). Without some form of corroborating evidence, an inventor's testimony is ignored. While before the Patent Office, an inventor may file a Rule 131 affidavit (see 37 C.F.R. § 1.131) to establish a date of invention. The patentee must corroborate this date.

14.3.4.1.2.2 Reduction to Practice

A reduction to practice can be actual or constructive. A prototype or working embodiment of the claimed invention that is "suitable for [the invention's] intended purpose" serves as an actual reduction to practice. See *Mahurkar v. C.R. Bard Inc.*, 79 F.3d 1572, 1578 (Fed. Cir. 1996). Proving that a prototype was "suitable for its intended purpose" will vary, depending on the complexity of the invention. A simple mechanical device may require only a drawing, while a chemical invention may require extensive experimental data. Patent law recognizes a patent application as a constructive reduction to practice, provided it describes and enables a person of ordinary skill in the art to practice the invention without undue experimentation.

14.3.4.1.2.3 Reasonable Diligence

“Reasonable diligence” is only at issue when the inventor was first to conceive but second to reduce to practice. In this specific context, the first-to-conceive inventor must have been reasonably diligent in working to reduce the invention to practice between the time “just prior” to the later inventor’s date of conception until the first-to-conceive inventor’s reduction to practice. *See, e.g., Griffith v. Kanamaru*, 816 F.2d 624 (Fed. Cir. 1987). Once the first-to-conceive has reduced to practice, their further diligence is no longer relevant, although they must not abandon the invention through undue delay in filing a patent application. *See* § 14.3.4.1.2.4.

Whether an inventor was reasonably diligent is a case-by-case determination, but prior cases establish some guideposts. *Griffith* held that a delay of three months after conception before embarking on efforts to reduce the invention to practice while waiting for additional funding and the arrival of a graduate student was not reasonable. 816 F.2d at 628–29. Other factors to consider include the complexity of the invention, the need for other experiments, work on similar inventions, and the inventor’s health.

14.3.4.1.2.4 Abandoned, Suppressed, or Concealed

Section 102(g) nullifies evidence of prior invention if such earlier inventor abandoned, suppressed, or concealed the invention. Whether an invention has been abandoned, suppressed, or concealed is a question of intent, but an unreasonably long delay in filing for a patent creates an inference that the inventor intended to suppress the invention. *See Dow Chem. Co. v. Astro-Valcour, Inc.*, 267 F.3d 1334 (Fed. Cir. 2001) (a two-and-a-half-year delay did not); *Peeler v. Miller*, 535 F.2d 647 (C.C.P.A. 1976) (a four-year delay in applying for a patent destroyed priority). While § 102(g) prevents an inventor from claiming an early priority date on an invention he or she later suppressed, it does not prevent an inventor from claiming a later date when he or she resumes work on the invention. In such cases, the earlier, suppressed work is ignored and the inventor can rely on the resumed work to establish new dates of conception and reduction to practice. *See Paulik v. Rizkalla*, 760 F.2d 1270 (Fed. Cir. 1985) (en banc).

By invalidating a claimed invention because of a prior invention that might not have been publicly disclosed, § 102(g) cuts against the principle that novelty is judged on the basis of public knowledge. The invention priority rule of § 102(g) seeks to balance that principle with the “first to invent” principle. The requirement that prior invention not have been “abandoned, suppressed, or concealed” provides the fulcrum for effectuating this balance.

14.3.4.1.2.5 Section 102(g)—Summary

The § 102(g) invention priority rule can be restated as follows:

- (1) The first to reduce the invention to practice has priority by default.
- (2) Filing a valid patent application is a constructive reduction to practice.

- (3) The second person to reduce to practice can prevail only if they were the first to conceive and were diligent from a time prior to the other inventor's conception through to their own reduction to practice.
- (4) Any reduction to practice that was abandoned, suppressed, or concealed cannot defeat patentability by another.

14.3.4.1.3 Novelty—"Secret Prior Art"—§ 102(e)

The possibility of secret prior art invalidating a patent also arises under § 102(e) whereby confidential patent applications within the Patent Office can be used to invalidate later filings.²³ If a patent application discloses but does not claim a later filed claimed invention and is later published, the application constitutes § 102(e)(1) prior art as of its filing date.²⁴ If the application later issues as a patent, such application constitutes § 102(e)(2) prior art as of its filing date. The policy rationale behind § 102(e) is that if another's earlier filed patent application describes the applicant's claimed invention, the applicant was not the first inventor of that subject matter. The fact that the knowledge was not publicly known is outweighed by the Patent Office's knowledge of the invention and its unique role in making patent determinations.

14.3.4.1.4 Novelty—Derivation—§ 102(f)

Section 102(f) precludes an applicant from obtaining a patent on inventions that he did not invent. This section is referred to as the "derivation" provision, meaning that an applicant may not patent subject matter derived from another. *See OddzOn Prods., Inc. v. Just Toys, Inc.*, 122 F.3d 1396, 1401 (Fed. Cir. 1997). Section 102(f) is not limited to public knowledge but may also concern private communications between the applicant and another. *Id.* at 1401–02. Proof that another derived the invention requires showing both prior conception of the invention and disclosure of that conception to the applicant. *See Gambro Lundia AB v. Baxter Healthcare Corp.*, 110 F.3d 1573, 1576 (Fed. Cir. 1997). Because there are no geographic limitations in § 102(f), prior conception and disclosure to the applicant can occur anywhere in the world.

14.3.4.1.5 Statutory Bars—Timely Filing—§ 102(b)

Section 102(b) arises frequently in patent litigation. The provision encourages timely filing of patent applications to expand the public's knowledge more quickly and prevent inventors from extending the effective life of their patent through delay in filing for protection. Section 102(b) states that a person shall be entitled to a pa-

23. A patent is considered "secret prior art" when its contents cannot become known until the date of publication or issuance, even though its effective date is the filing date. *Sun Studs, Inc. v. ATA Equip. Leasing, Inc.*, 872 F.2d 978, 982 n.3 (Fed. Cir. 1989).

24. If the pending application *claims* (and not merely discloses) the same invention, then it constitutes § 102(g) prior art and will provoke an interference if such conflict is recognized by an examiner.

tent unless “the invention was patented or described in a printed publication in this or a foreign country or in public use or on sale in this country, more than one year prior to the date of the application for patent in the United States. . . .”

The section recognizes three types of prior art: “printed publication,” “public use,” and offers for sale. Printed publications can come from anywhere in the world. The second and third categories of reference, public use or offers for sale, only invalidate the claimed invention if they occur in the U.S. The second salient feature of this provision is the critical date: one year prior to the date of the application. Any reference before the critical date—whether originating from the inventor or a third party—invalidates the patent claims that “read on” the reference. Each of these concepts has generated substantial jurisprudence. “Printed publication” and “public use” were discussed above with respect to § 102(a), *see* § 14.3.4.1.1, and their meanings are the same under § 102(b). “On sale” is unique to § 102(b).

14.3.4.1.5.1 Experimental Use

To accommodate circumstances in which inventors need to experiment in publicly accessible areas in making certain types of inventions, courts developed an “experimental use” exception to § 102(b)’s “public use” bar. *See City of Elizabeth v. Am. Nicholson Pavement Co.*, 97 U.S. 126 (1877).²⁵ The determination of whether an otherwise public use is experimental depends on balancing the following circumstances: “the number of prototypes and duration of testing, whether records or progress reports were made concerning the testing, the existence of a secrecy agreement between the patentee and the party performing the testing, whether the patentee received compensation for the use of the invention, and the extent of control the inventor maintained over the testing.” *Lough v. Brunswick Corp.*, 86 F.3d 1113, 1120–21 (Fed. Cir. 1996). Of these factors, the Federal Circuit has emphasized the degree of control the inventor maintained because if it is absent, the inventor “is not experimenting.” *Id.* at 1120. Any experimentation must be in regard to establishing that the claimed invention works for its intended purpose, and not, for example, for refining a product to improve marketability. *See In re Smith*, 714 F.2d 1127 (Fed. Cir. 1983). Once reduction to practice is achieved, the experimental use exception ends and § 102(b)’s one-year grace period begins to run.

14.3.4.1.5.2 On Sale Bar

Section 102(b)’s “on-sale bar” can be triggered by behavior that also runs afoul of the “public use” bar, in which case both provisions invalidate the claim. The more difficult and contentious cases involve offers or sales that do not occur in public. Such information is typically revealed through pretrial discovery.

The on-sale bar can be strict in its application. A single offer to sell technology can invalidate the patent, and it can be made by anyone, even a third party unknown

25. This type of “experimental use” applicable to § 102(b) is distinct from the “experimental use” defense to patent infringement. *See* § 14.4.2.2.2.

to the patentee. See, e.g., *Abbott Labs. v. Geneva Pharm.*, 182 F.3d 1315 (Fed. Cir. 1999). The invention does not even have to be built. The Supreme Court interpreted the on-sale bar to require only that the invention be “ready for patenting” when subject to a commercial offer for sale. *Pfaff v. Wells Elecs.*, 525 U.S. 55 (1998). An invention is “ready for patenting” if it has been actually reduced to practice by being physically constructed or if there are “drawings or other descriptions of the invention sufficiently detailed to enable a person skilled in the art to practice the invention.” *Id.* at 67.

Some additional nuances in the jurisprudence favor the patentee. First, the statute states that the “invention” must be placed on sale. The courts have interpreted this to mean that the offer for sale must involve an embodiment of the invention. Licensing activity does not trigger the on-sale bar so long as there is no embodiment of the invention at issue. See *In re Kollar*, 286 F.3d 1326 (Fed. Cir. 2002). For process claims, the process has to be carried out or performed to constitute a sale. *Kollar*, 286 F.3d at 1332–33 (“[B]ecause the . . . Agreement did not involve the sale of a product of the claimed process, but rather provided . . . a license to practice the claimed process and ‘information defining an embodiment’ of that process, that agreement did not trigger the on-sale bar.”) (footnote omitted). Second, the invention must be subject to a genuine commercial offer for sale. A patentee does not violate the on-sale bar by distributing advertisements and data sheets to prospective buyers while fielding requests for samples from salesmen in the field because this behavior does not rise to the level of an “offer.” See, e.g., *Linear Tech. Corp. v. Micrel Inc.*, 275 F.3d 1040 (Fed. Cir. 2001).²⁶ The Federal Circuit has incorporated the Uniform Commercial Code and “traditional contract law principles” to determine whether an offer is genuine for purposes of applying the on-sale bar. Third, an offer to sell must be between unrelated parties. Hence, offers between a parent and a subsidiary do not trigger the bar. See *Ferag AG v. Quipp Inc.*, 45 F.3d 1562 (Fed. Cir. 1995).

The on-sale bar is subject to a territorial restriction. Only if the claimed invention is “on sale in this country” is the patent claim invalid. Determining whether an invention is “on sale in this country” can be difficult in the rapidly globalizing economy. For example, a foreign supplier’s response that it was ready to fulfill a purchase order request of a patented invention before the critical date triggers the on-sale bar. *Hamilton Beach Brands v. Sunbeam Prods., Inc.*, 726 F.3d 1370 (Fed. Cir. 2013). As with deciding whether an offer was made, courts look to “traditional contract law principles” to determine the locus of an offer.

26. But note that a detailed advertisement can constitute a printed publication if it enables the invention.

14.3.4.1.6 Statutory Bars—Abandonment—§ 102(c)

Under § 102(c), an applicant is entitled to a patent unless he or she “has abandoned the invention.”²⁷ This section is a loss-of-right provision. *See OddzOn Prods., Inc. v. Just Toys, Inc.*, 122 F.3d 1396, 1402 (Fed. Cir. 1997). It refers to an inventor’s express dedication of his or her invention to the public through either deliberate surrender or conduct showing an intent not to pursue patent protection. Abandonment under § 102(c) occurs only based on actions by the inventor after he or she has made the invention but before he or she has filed the patent application. *See id.* at 1404.

14.3.4.1.7 Statutory Bars—International Filing—§ 102(d)

Under § 102(d), a patent may not issue where (1) the inventor filed a foreign patent application more than twelve months prior to filing the U.S. patent application, and (2) a patent issued from that foreign application prior to the U.S. filing date.²⁸ This provision encourages applicants to file their U.S. applications promptly after filing foreign applications. *See In re Kathawala*, 9 F.3d 942, 946 (Fed. Cir. 1993). Like § 102(c), violation of this provision results in the loss of right. *See OddzOn Prods, Inc.*, 122 F.3d at 1402. Owing to the Patent Cooperation Treaty (PCT), which facilitates and coordinates international patent prosecutions, patent invalidations under § 102(d) rarely occur today.

Validity of the foreign claims is immaterial to the § 102(d) determination. What matters to the inquiry is that the foreign patent issued “with claims directed to the same invention as the U.S. application.” *In re Kathawala*, 9 F.3d at 945.

14.3.4.2 The First-to-File Regime

For patent applications having at least one claim with an effective filing date on or after March 16, 2013, the novelty requirement is governed by the amendments to Title 35 introduced in the AIA. *See* AIA § 3. Accordingly, all references to § 102 and other statutory provisions in Title 35 in § 14.3.4.2 will refer to the AIA-amended version, unless specified otherwise.

14.3.4.2.1 Novelty and Prior Art—§ 102(a)

Section 102(a), as amended by the AIA, provides as follows:

(a) NOVELTY; PRIOR ART.—A person shall be entitled to a patent unless—

(1) the claimed invention was patented, described in a printed publication, or in public use, on sale, or otherwise available to the public before the effective filing date of the claimed invention; or

27. Abandonment under § 102(c) and that under § 102(g) are separate concepts. While § 102(c) relates to abandonment of the right to receive a patent, § 102(g) refers to abandonment of the invention itself. *See* § 14.3.4.1.2.4.

28. Foreign patents of others can constitute prior art references under § 102(a) and (b).

(2) the claimed invention was described in a patent issued under section 151, or in an application for patent published or deemed published under section 122(b), in which the patent or application, as the case may be, names another inventor and was effectively filed before the effective filing date of the claimed invention.

§ 102(a) (as amended by AIA § 3). Section 102(a) establishes novelty and awards priority based on the “effective filing date” of the claimed invention, which is “the filing date of the earliest application for which the patent or application is entitled, as to such invention, to a right of priority. . . .” § 100(i)(1)(B) (as amended by AIA § 3). In essence, the “effective filing date” (also called the “priority date”) for a claimed invention is the filing date of the earliest application in a family of related applications that provides support under § 112 for that claimed invention. If a U.S. application claims priority from a foreign application, the “effective filing date” may be the date on which that foreign application was initially filed.

Compared to the first-to-invent regime, the first-to-file version of § 102(a) broadens the scope of prior art and novelty-defeating events in several key respects: (1) it eliminates the ability to “swear behind” a prior art reference based on the date of invention; (2) it provides a novelty-defeating catch-all category (“or otherwise available to the public”); (3) novelty-defeating prior public use or “on-sale” events are not limited to activities in the U.S.; and (4) because the effective filing date includes the foreign priority date, U.S. patents and published applications claiming priority to a foreign application are considered prior art as of their foreign priority date (rather than their later U.S. filing date under the pre-AIA version of § 102). *See also* § 102(d) (as amended by AIA § 3). Nonetheless, the USPTO has interpreted the “or otherwise available to the public” language as limiting the other art referenced in 102(a)(1) to be only art that is “available to the public.” Therefore, “secret sales,” which were considered prior art prior to the AIA, are no longer considered prior art by the PTO.

14.3.4.2.2 Novelty—Grace Period and Exceptions to Prior Art—§ 102(b)

Section 102(b), as amended by the AIA, provides for a grace period as well as certain exceptions to prior art, as follows:

(b) EXCEPTIONS.—

(1) DISCLOSURES MADE 1 YEAR OR LESS BEFORE THE EFFECTIVE FILING DATE OF THE CLAIMED INVENTION.—A disclosure made 1 year or less before the effective filing date of a claimed invention shall not be prior art to the claimed invention under subsection (a)(1) if—

(A) the disclosure was made by the inventor or joint inventor or by another who obtained the subject matter disclosed directly or indirectly from the inventor or a joint inventor; or

(B) the subject matter disclosed had, before such disclosure, been publicly disclosed by the inventor or a joint inventor or another who obtained the subject matter disclosed directly or indirectly from the inventor or a joint inventor.

(2) DISCLOSURES APPEARING IN APPLICATIONS AND PATENTS.—A disclosure shall not be prior art to a claimed invention under subsection (a)(2) if—

(A) the subject matter disclosed was obtained directly or indirectly from the inventor or a joint inventor;

(B) the subject matter disclosed had, before such subject matter was effectively filed under subsection (a)(2), been publicly disclosed by the inventor or a joint inventor or another who obtained the subject matter disclosed directly or indirectly from the inventor or a joint inventor; or

(C) the subject matter disclosed and the claimed invention, not later than the effective filing date of the claimed invention, were owned by the same person or subject to an obligation of assignment to the same person.

§ 102(b) (as amended by AIA § 3). Section 102(b)(1) gives priority to the first inventor to “disclose” the invention, whether directly or indirectly (e.g., by another who derived the invention from the applicant), if the inventor files an application within a year of the disclosure. If the U.S. application claims priority from a foreign application, the one-year grace period is measured from the foreign priority date. Notably, the statute does not define what qualifies as a “disclosure” for purposes of the grace period, thereby leaving it open to development through case law.

Section 102(b)(2) disqualifies certain patents and patent applications as prior art if the disclosed subject matter was derived from or previously “publicly disclosed” by the inventor (or a joint inventor), or shares a common owner with the claimed invention.

14.3.4.2.3 Novelty—Joint Research—§ 102(c)

Section § 102(c) provides that subject matter developed under a joint research agreement is deemed “commonly owned” for the purposes of the “common ownership” exception to prior art under § 102(b)(2)(C):

(c) COMMON OWNERSHIP UNDER JOINT RESEARCH AGREEMENTS.— Subject matter disclosed and a claimed invention shall be deemed to have been owned by the same person or subject to an obligation of assignment to the same person in applying the provisions of subsection (b)(2)(C) if—

(1) the subject matter disclosed was developed and the claimed invention was made by, or on behalf of, 1 or more parties to a joint research agreement that was in effect on or before the effective filing date of the claimed invention;

(2) the claimed invention was made as a result of activities undertaken within the scope of the joint research agreement; and

(3) the application for patent for the claimed invention discloses or is amended to disclose the names of the parties to the joint research agreement.

§ 102(c) (as amended by AIA § 3). The § 102(c) “joint research” exception to prior art applies if: (1) the joint research agreement was in effect before the effective filing date; (2) the invention resulted from activities within the scope of the joint research agreement; and (3) the patent application discloses the parties to the joint research

agreement. Notably, the § 102(c) “joint research” exception introduced under the AIA is analogous to the pre-AIA version of § 103(c) applicable to obviousness issues.

14.3.4.2.4 Effective Date of Patent Prior Art—§ 102(d)

Section 102(d) defines when patents and published applications may qualify as prior art:

(d) PATENTS AND PUBLISHED APPLICATIONS EFFECTIVE AS PRIOR ART.—For purposes of determining whether a patent or application for patent is prior art to a claimed invention under subsection (a)(2), such patent or application shall be considered to have been effectively filed, with respect to any subject matter described in the patent or application—

(1) if paragraph (2) does not apply, as of the actual filing date of the patent or the application for patent; or

(2) if the patent or application for patent is entitled to claim a right of priority under Section 119, 365(a), or 365(b), or to claim the benefit of an earlier filing date under Section 120, 121, or 365(c), based upon 1 or more prior filed applications for patent, as of the filing date of the earliest such application that describes the subject matter.

§ 102(d) (as amended by AIA § 3). Compared to the first-to-invent regime, the universe of patent prior art in the first-to-file regime is broader in a couple of major respects: (1) an applicant cannot “swear behind” a prior art patent or published application based on a prior invention date; and (2) U.S. patents and published applications claiming priority to a foreign application may qualify as prior art as of their foreign priority date (rather than being restricted to the U.S. filing date under the pre-AIA version of § 102).

14.3.4.2.5 Derivation Proceedings

Under the first-to-file regime, interference proceedings are replaced by “derivation proceedings” in which an inventor may challenge an earlier-filed third-party application or patent claiming subject matter that was derived from the inventor’s own work. *See* AIA § 3 (amending §§ 135 and 291).

Derivation proceedings have timing restrictions. In the USPTO, a derivation proceeding must be requested within one year of the publication of a claim directed to the allegedly derived invention. *See* § 135. If a derivation proceeding is pursued as a civil action under § 146, the suit must be filed within a year of the issuance of the patent containing a claim to the allegedly derived invention. *See* § 291.

14.3.5 Nonobviousness—§ 103

14.3.5.1 Historical Development

Some measure of inventiveness has been required to receive a patent since the seminal case of *Hotchkiss v. Greenwood*, 52 U.S. 248 (1850), where the Supreme Court held that the patent law’s concept of “invention” required going beyond the

skill or ingenuity of an “ordinary mechanic acquainted with the business.” *Id.* at 267. Over the following century, the “invention” requirement grew more stringent, leading to the controversial “flash of creative genius” test, *see Cuno Engineering Corp. v. Automatic Devices Corp.*, 314 U.S. 84, 91 (1941), and the “unusual or surprising consequences” test, *see Great A & P Tea Co. v. Supermarket Equipment Corp.*, 340 U.S. 147 (1950). This high bar to patentability was ultimately replaced with a less stringent nonobviousness standard in the Patent Act of 1952.

14.3.5.2 Nonobviousness Standard

As explained in the previous section on novelty and statutory bars under § 102, *see* § 14.3.4, the regime under which patents are granted in the U.S. changed on March 16, 2013, from a first-to-invent system to a first-to-file system. AIA § 3. Under the AIA, § 103 was rewritten to conform to the first-to-file framework set forth in the amended version of § 102. The primary substantive difference in the two filing regimes for analyzing obviousness under § 103 is the relevant time at which obviousness is evaluated: Under the first-to-invent regime, obviousness is evaluated at the time of invention, whereas under the first-to-file regime, it is evaluated as of the effective filing date.

14.3.5.2.1 Nonobviousness Under the First-to-Invent Regime

The pre-AIA version of § 103(a) states that:

A patent may not be obtained though the invention is not identically disclosed or described as set forth in section 102 of this title, if the differences between the subject matter sought to be patented and the prior art are such that the subject matter as a whole would have been obvious at the time the invention was made to a person having ordinary skill in the art to which said subject matter pertains. Patentability shall not be negated by the manner in which the invention was made.

Id. The text provides some structure for the nonobviousness inquiry. Under the first-to-invent regime, obviousness must be determined at the time of invention from the perspective of a person having ordinary skill in the art. As suggested by the last sentence, the manner of invention is irrelevant. An invention is eligible for patent protection whether accidental or nearly instantaneous so long as it meets the test set forth in the first sentence of § 103(a).

The Supreme Court provided an analytical framework for nonobviousness in *Graham v. John Deere Co. of Kan. City*, 383 U.S. 1 (1966), which required courts to make findings regarding the “scope and content of prior art,” the “differences between the prior art and claims at issue,” and the “level of ordinary skill in the pertinent art.” *Id.* at 17. The Court also brought consideration of secondary factors—what might be deemed circumstantial evidence of inventiveness (such as long-felt need, failure of others, praise for the invention, and unexpected results)—into the determination of whether an invention was obvious at the time it was made. *Id.* at 17–18. In 2007, the Supreme Court reaffirmed the *Graham* framework and emphasized that the inquiry under § 103 is flexible, “broad” and open-ended. *KSR Int’l Co. v. Teleflex, Inc.*, 550 U.S. 398 (2007).

14.3.5.2 Nonobviousness Under the First-to-File Regime

Section 103, as amended under the AIA, states:

A patent for a claimed invention may not be obtained, notwithstanding that the claimed invention is not identically disclosed as set forth in section 102, if the differences between the claimed invention and the prior art are such that the claimed invention as a whole would have been obvious before the effective filing date of the claimed invention to a person having ordinary skill in the art to which the claimed invention pertains. Patentability shall not be negated by the manner in which the invention was made.

§ 103 (as amended by AIA § 3). Compared to the pre-AIA version of § 103 that is applicable under the first-to-invent regime, the amended version of § 103 that is applicable to the first-to-file regime is a single paragraph that focuses the non-obviousness inquiry as of the effective filing date.

Much of the case law developed under the first-to-invent regime for evaluating obviousness is generally applicable under the first-to-file regime as well, by substituting the relevant time for evaluating obviousness to be the effective filing date rather than the date of invention.

14.3.5.3 Applying § 103

Courts generally assess nonobviousness by first ascertaining the level of ordinary skill in the art, then analyzing the pertinent prior art, and finally assessing the difference between the baseline of prior art and the claimed invention from the standpoint of a person having ordinary skill in the art as of the relevant time. Under the first-to-invent regime, obviousness is evaluated at the time the invention was made, whereas under the first-to-file regime, obviousness is evaluated as of the effective filing date.

14.3.5.3.1 Determining the Level of Ordinary Skill in the Art

In determining the level of ordinary skill in the art, courts look to the inventor's educational level, the nature of the field's typical problems, the skill required to grapple with the prior solutions to the field's problems, the pace of innovation in the field, the sophistication of technology, and the educational level of people working in the field. See *Env'tl. Designs, Ltd. v. Union Oil Co.*, 713 F.2d 693, 696 (Fed. Cir. 1983). In practice, the alleged infringer will argue that the level of ordinary skill is very high, so that the invention appears obvious to the person of ordinary skill, whereas the patentee will often suggest a very low level of ordinary skill, so that the invention instead appears nonobvious.

Some opinions make explicit determinations of the person of ordinary skill, as did the district court in *KSR* ("an undergraduate degree in mechanical engineering (or an equivalent amount of industry experience) [and] familiarity with pedal control systems for vehicles," *Teleflex Inc. v. KSR Int'l*, 298 F. Supp. 2d 581, 590 (E.D. Mich. 2003)), although it is not uncommon for courts to leave this determination somewhat vague. For example, in *Environmental Designs, Ltd. v. Union Oil Co.*, 713 F.2d 693 (Fed. Cir. 1983), the parties conceded that each side's experts were persons

of ordinary skill in the art. Moreover, “a specific finding on the level of skill in the art is not . . . required where the prior art itself reflects an appropriate level and a need for testimony is not shown.” *Litton Indus. Prods., Inc. v. Solid State Sys., Corp.*, 755 F.2d 158, 163–64 (Fed. Cir. 1985). Table 14.3 provides illustrative findings of the person of ordinary skill in the context of particular fields of invention:

Table 14.3
Illustrative Findings of a Person Having Ordinary Skill

Case	Field of Invention	Person Having Ordinary Skill
<i>Micro Motion, Inc. v. Exac Corp.</i> , 741 F. Supp. 1426 (N.D. Cal. 1990)	devices that measure the flow rate of fluids, for example, in a pipeline	“A design engineer with a college degree in mechanical engineering or the equivalent, and who had several years of experience in the design and development of flow measurement and control instruments.”
<i>Sud-Chemie, Inc. v. CSP Techs., Inc.</i> , 2006 U.S. Dist. LEXIS 54873, 2006 WL 2246404 (S.D. Ind. Aug. 4, 2006)	polymer blends with specific structural qualities	“A Ph.D.-level scientist [in the field of polymer chemistry].”
<i>Imperial Chem. Indus., PLC v. Danbury Pharmacal, Inc.</i> , 777 F. Supp. 330 (D. Del. 1991)	method for treating patients suffering from hypertension	“A person of ordinary skill in the art would be an individual with a Ph.D. degree in organic chemistry, with an emphasis in medicinal chemistry and experience with the techniques of drug development in general and specific experience with the development of beta-blockers.”
<i>Eli Lilly & Co. v. Teva Pharm. USA, Inc.</i> , 2004 U.S. Dist. LEXIS 14724, 2004 WL 1724632 (July 29, 2004)	method of treating patients suffering from premenstrual syndrome	“A hypothetical medical doctor (an OB/GYN, a family practice physician, or a psychiatrist) who: (1) regularly sees and treats patients suffering from PMS, and (2) is familiar with the relevant prior art.”

Case	Field of Invention	Person Having Ordinary Skill
<i>Rosen Enter. Sys., LP v. Icon Enters., Inc.</i> , 359 F. Supp. 2d 902 (C.D. Cal. 2005)	flip-down screens for cars	“The level of ordinary skill here is a technical knowledge of the design and installation of overhead flip-down display units for automobiles.”
<i>Windsurfing Int’l, Inc. v. Fred Ostermann GmbH</i> , 613 F. Supp. 913 (S.D.N.Y. 1985), <i>aff’d in relevant part</i> , <i>Windsurfing Int’l, Inc. v. AMF, Inc.</i> , 782 F.2d 995 (Fed. Cir. 1986)	sails	“The hypothetical person of ordinary skill in the art of sailboat design in 1967 had either a combination of several years sailing experience and several years of practical experience designing and/or constructing sailboats or, alternatively, he possessed a college degree in design or engineering as well as a general knowledge of sailing.”

14.3.5.3.2 Scope and Content of the Prior Art

Because § 103 does not expressly define what constitutes “prior art,” courts have looked to § 102 for the classes of references that can qualify as “prior art” references for the § 103 inquiry. In most cases, a reference that could be prior art under § 102 can qualify as a reference for § 103 purposes. *See OddzOn Prods., Inc. v. Just Toys, Inc.*, 122 F.3d 1396 (Fed. Cir. 1997). However, the range of prior art available for an obviousness analysis will be slightly different depending on whether the claim at issue was filed under the first-to-invent regime or the first-to-file regime.

Under the first-to-invent regime, it is worth noting that, notwithstanding the test of § 103, which measures obviousness as of the time of invention, § 102(b) references can also apply in making § 103 obviousness determinations, even though they are effective as of one year prior to the application filing date (and hence may post-date the time of invention). *See OddzOn Products*, 122 F.3d at 1402; *In re Foster*, 343 F.2d 980 (C.C.P.A. 1965); 2 Donald S. Chisum, *Chisum on Patents* § 5.03[2][b].

Both the first-to-invent and first-to-file regimes provide “joint research” exceptions to prior art. To prevent companies from having one group of employees’ non-public research used as prior art against other employees’ inventions, § 103(c), under the first-to-invent regime, excludes consideration of §§ 102(e), (f), and/or (g) references if it comes from the inventor, his or her firm, or someone with an assignment obligation to the patenting enterprise. The analogous provision under the first-to-file regime is provided under § 102(c).

A § 103 reference must also come from an “analogous art” to satisfy the presumption that a person having ordinary skill in the art would be familiar with it. Courts base this determination upon whether the reference is “from the same field of endeavor, regardless of the problem addressed,” and if not, whether the reference is

“reasonably pertinent to the particular problem with which the inventor is involved.” See *In re Clay*, 966 F.2d 656 (Fed. Cir. 1992); see also *In re Paulsen*, 30 F.3d 1475 (Fed. Cir. 1994). A prior art reference qualifies as analogous art if it satisfies either inquiry. Table 14.4 illustrates this mode of analysis:

Table 14.4
Assessing Whether Prior Art Is Analogous

Case	Field of Invention	Reference	Same Field?	Same Problem?
<i>AstraZeneca Pharms., LP v. Mayne Pharma (USA) Inc.</i> , 2005 U.S. Dist. LEXIS 26196, 2005 WL 2864666 (S.D.N.Y. Nov. 2, 2005)	Pharmaceutical formulation	Patent related to sludge formation in fuel	No	No
<i>Festo Corp. v. Shoketsu Kinzoku Kogyo Kabushiki Co., Ltd.</i> , 2005 U.S. Dist. LEXIS 11621, 2005 WL 1398528 (D. Mass. June 10, 2005)	Sealing rings for large magnetic devices	Sealing rings for small magnetic devices	Yes	Yes

14.3.5.3 Differences Between Invention and Prior Art

Once the level of ordinary skill in the art and the applicable prior art have been identified, the trier of fact assesses the differences between the claimed invention and the prior art.

14.3.5.3.4 Secondary Considerations

The Supreme Court in *Graham* suggested a number of secondary considerations to guide the obviousness inquiry. As the Court reaffirmed in *KSR*, the list of secondary considerations is not exclusive; a court may look to “any secondary considerations that would prove instructive” as to whether an invention was obvious. *KSR*, 550 U.S. at 415. The Federal Circuit requires that there be a nexus between the proffered secondary consideration and the claimed invention. The Federal Circuit requires district courts to make findings regarding secondary considerations. See *Custom Accessories, Inc. v. Jeffrey-Allen Indus., Inc.*, 807 F.2d 955 (Fed. Cir. 1986). Below are the most widely cited secondary considerations.

14.3.5.3.4.1 Long-Felt Need and Failure by Others

The *Graham* Court suggested that a claimed invention that solves a “long-felt need” within an industry would likely be nonobvious. Evidence that many others within the field have tried and failed to make the claimed invention suggests that the claimed invention was not obvious to a person of ordinary skill in the art. For example, in *Texas Instruments, Inc. v. United States International Trade Commission*, 988 F.2d 1165, 1178 (Fed. Cir. 1993), the evidence showed that the semiconductor industry had attempted but failed to package semiconductors in plastic for over six years prior to the invention. The patentee’s invention solved the problem of damaged components by insulating semiconductors in plastic. *Id.*

14.3.5.3.4.2 Awards and Praise

Awards or praise for an invention may suggest that it represents a significant advance. For example, in *W.L. Gore & Associates, Inc. v. Garlock, Inc.*, 721 F.2d 1540 (Fed. Cir. 1983), the Federal Circuit noted the industry’s characterization of Gore-Tex as “magical” and “a remarkable new material,” along with other secondary indicia (commercial success, long-felt need), to find the invention nonobvious. When analyzing patent claims that cover a component of a larger system, the only awards or praise that are relevant for § 103 are those specifically relating to the patented component, rather than to the system as a whole.

14.3.5.3.4.3 Skepticism, “Teaching Away,” and Unexpected Results

If the literature in the relevant field suggested prior to the relevant time for evaluating obviousness that the claimed solution was impossible, that suggests that the invention was nonobvious. See, e.g., *United States v. Adams*, 383 U.S. 39, 51–52 (1966). In *Adams*, the prior art discouraged experimenting with the combination that led to the patented invention as risky and unlikely to be successful.²⁹ *Id.* The Court relied on this background evidence to find that a person having ordinary skill in the art would have found it nonobvious. *Id.* The record in *Adams* also showed that many experts disbelieved Adams’s results, only to later apply for patents on improvements on Adams’s invention. *Id.* at 52.

Unexpected results that contradict long-held industry assumptions or beliefs can also demonstrate that the claimed invention was nonobvious at the relevant time. In *American Hoist & Derrick Co. v. Sowa & Sons*, 725 F.2d 1350 (Fed. Cir. 1984), the patentee demonstrated that a thin coating of chemicals could produce stronger safety glass than a thick coating, which was contrary to accepted beliefs in the industry at the time.

29. This discouragement is referred to as “teaching away” from the invention.

14.3.5.3.4.4 Licensing Activity

Extensive licensing may suggest that industry actors consider the patented invention nonobvious. *See, e.g., Eibel Process Co. v. Minn. & Ont. Paper Co.*, 261 U.S. 45, 53–56 (1923). However, patent holders routinely cross-license portfolios of patents without considering individual claims. Accordingly, a court should examine whether a nexus exists between the decision to license and the claimed invention.

14.3.5.3.4.5 Copying

Copying by others may give rise to an inference that an invention is nonobvious. *See, e.g., Diamond Rubber Co. v. Consol. Rubber Tire Co.*, 220 U.S. 428, 440–41 (1911). Courts should exercise caution in evaluating this factor because patentees routinely accuse alleged infringers of “copying” their invention. In addition, some alleged infringers may copy the invention believing that the patent is invalid; accordingly, the mere fact of copying should not defeat alternative arguments of obviousness.

14.3.5.3.4.6 Commercial Success

If a claimed invention is successful in the marketplace because of its patented features, the invention may be nonobvious. *See, e.g., Hybritech, Inc. v. Monoclonal Antibodies, Inc.*, 802 F.2d 1367 (Fed. Cir. 1986). When looking at commercial success as an indication of nonobviousness, courts should carefully assess the nexus between the success and the patent claim. This is particularly important when the patented technology is but one component in a larger system. Consider a patented air bag that an automaker installs on all of its new vehicles. The automaker cannot point to its overall car sales as evidence of nonobviousness unless it can show that the improved airbag is a key factor in car sales. It is likely, however, that consumers are basing their purchasing decisions on a wide variety of factors, such as engine performance, fuel economy, and body design. If, on the other hand, the automaker can demonstrate that safety-conscious buyers bought its cars in large numbers because of the new airbag technology, that evidence would favor a finding that the claimed invention is nonobvious.

14.3.5.3.5 The Ultimate Conclusion and Combining References

With these factual predicates—the level of ordinary skill in the art, the analogous prior art, the differences between the invention and the prior art, and the pertinent secondary considerations—the court then determines as a question of law whether the claimed invention as a whole would have been obvious to a person having ordinary skill in the art as of the relevant time. *KSR Int’l Co. v. Teleflex, Inc.*, 550 U.S. 398 (2007); *Graham*, 383 U.S. at 17–18; *Pharmastem Therapeutics, Inc. v. Viacell, Inc.*, 491 F.3d 1342 (Fed. Cir. 2007); *see generally* § 7.3.4.4. The person having ordinary skill in the art is presumed to know all analogous prior art.

Many cases raising nonobviousness will involve a claimed invention that is a combination of preexisting elements or components. Where all of the limitations were known in the prior art, the question becomes whether it was obvious for a person having ordinary skill in the art to combine those features to address a known problem. Prior to *KSR*, the Federal Circuit applied a doctrine referred to as the “teaching, suggestion, or motivation” or “TSM” test which required evidence of an explicit cross-reference linking the preexisting restrictions from disparate references and that a person having ordinary skill in the art would not have to engage in undue experimentation to create the combination. The *KSR* Court rejected this “rigid formulation.” 550 U.S. at 415. Instead, the Court suggested that in many fields “market demand” may compel an inventor to combine prior art elements. *Id.* at 419. The *KSR* Court stressed that nonobviousness cannot be reduced to a single inquiry. Instead, the inquiry is expansive, flexible, and functional. For example, the Court suggested that, “[o]ne of the ways in which a patent’s subject matter can be proved obvious is by noting that there existed at the [relevant time] a known problem for which there was an obvious solution encompassed by the patent’s claims.” *Id.* at 1742.

Since *KSR*, the Federal Circuit has held that merely replacing known mechanical components of an invention with electronic parts is likely to be obvious. See *Leapfrog Enters., Inc. v. Fisher-Price, Inc.*, 485 F.3d 1157 (Fed. Cir. 2007). Often, advances in collateral technologies—such as advances in digital technology or the development of the Internet—or the emergence of market demand (as occurred in *KSR*) will enable persons having ordinary skill in the art to apply known technologies or skills in new but obvious ways that have tremendous value. Section 103 bars patents on such techniques.

The flexible, broad, and open-ended nonobviousness inquiry adopted by the Federal Circuit in its post-*KSR* decisions has been synthesized by the USPTO in a set of examination guidelines for its patent examiners. Examination Guidelines Update: Developments in the Obviousness Inquiry after *KSR v. Teleflex*, 75 Fed. Reg. 53643 (2010). Table 14.5–14.8 summarize those guidelines:

**Table 14.5
Combining Prior Art Elements**

Case	Teaching Point
<i>In re Omeprazole Patent Litig.</i> , 536 F.3d 1361 (Fed. Cir. 2008)	Even where a general method that could have been applied to make the claimed product was known and within the level of skill of the ordinary artisan, the claim may nevertheless be nonobvious if the problem which had suggested use of the method had been previously unknown.
<i>Crocs, Inc. v. U.S. Int’l Trade Comm’n.</i> , 598 F.3d 1294 (Fed. Cir. 2010)	A claimed combination of prior art elements may be non-obvious where the prior art teaches away from the claimed combination and the combination yields more than predictable results.

Case	Teaching Point
<i>Sundance, Inc. v. DeMonte Fabricating Ltd.</i> , 550 F.3d 1356 (Fed. Cir. 2008)	A claimed invention is likely to be obvious if it is a combination of known prior art elements that would reasonably have been expected to maintain their respective properties or functions after they have been combined.
<i>Ecolab, Inc. v. FMC Corp.</i> , 569 F.3d 1335 (Fed. Cir. 2009)	A combination of known elements would have been <i>prima facie</i> obvious if an ordinarily skilled artisan would have recognized an apparent reason to combine those elements and would have known how to do so.
<i>Wyers v. Master Lock Co.</i> , 616 F.3d 1231 (Fed. Cir. 2010)	The scope of analogous art is to be construed broadly and includes references that are reasonably pertinent to the problem that the inventor was trying to solve. Common sense may be used to support a legal conclusion of obviousness so long as it is explained with sufficient reasoning.
<i>DePuy Spine, Inc. v. Medtronic Sofamor Danek, Inc.</i> , 567 F.3d 1314 (Fed. Cir. 2009)	Predictability as discussed in <i>KSR</i> encompasses the expectation that prior art elements are capable of being combined, as well as the expectation that the combination would have worked for its intended purpose. An inference that a claimed combination would not have been obvious is especially strong where the prior art's teachings undermine the very reason being proffered as to why a person of ordinary skill would have combined the known elements.

Table 14.6
Substituting One Known Element for Another

Case	Teaching Point
<i>In re ICON Health & Fitness, Inc.</i> , 496 F.3d 1374 (Fed. Cir. 2007)	When determining whether a reference in a different field of endeavor may be used to support a case of obviousness (i.e., is analogous), it is necessary to consider the problem to be solved.
<i>Agrizap, Inc. v. Woodstream Corp.</i> , 520 F.3d 1337 (Fed. Cir. 2008)	Analogous art is not limited to references in the field of endeavor of the invention, but also includes references that would have been recognized by those of ordinary skill in the art as useful for applicant's purpose.
<i>Muniauction, Inc. v. Thomson Corp.</i> , 532 F.3d 1318 (Fed. Cir. 2008)	Because Internet and web browser technologies had become commonplace for communicating and displaying information, it would have been obvious to adapt existing processes to incorporate them for those functions.

Case	Teaching Point
<i>Aventis Pharma Deutschland v. Lupin, Ltd.</i> , 499 F.3d 1293 (Fed. Cir. 2007)	A chemical compound would have been obvious over a mixture containing that compound as well as other compounds where it was known or the skilled artisan had reason to believe that some desirable property of the mixture was derived in whole or in part from the claimed compound, and separating the claimed compound from the mixture was routine in the art.
<i>Eisai Co. Ltd. v. Dr. Reddy's Labs., Ltd.</i> , 533 F.3d 1353 (Fed. Cir. 2008)	A claimed compound would not have been obvious where there was no reason to modify the closest prior art lead compound to obtain the claimed compound and the prior art taught that modifying the lead compound would destroy its advantageous property. Any known compound may serve as a lead compound when there is some reason for starting with that lead compound and modifying it to obtain the claimed compound.
<i>Procter & Gamble Co. v. Teva Pharm. USA, Inc.</i> , 566 F.3d 989 (Fed. Cir. 2009)	It is not necessary to select a single compound as a “lead compound” in order to support an obviousness rejection. However, where there was reason to select and modify the lead compound to obtain the claimed compound, but no reasonable expectation of success, the claimed compound would not have been obvious.
<i>Altana Pharma AG v. Teva Pharms. USA, Inc.</i> , 566 F.3d 999 (Fed. Cir. 2009)	Obviousness of a chemical compound in view of its structural similarity to a prior art compound may be shown by identifying some line of reasoning that would have led one of ordinary skill in the art to select and modify a prior art lead compound in a particular way to produce the claimed compound. It is not necessary for the reasoning to be explicitly found in the prior art of record, nor is it necessary for the prior art to point to only a single lead compound.

Table 14.7
The Obvious-to-Try Rationale³⁰

Case	Teaching Point
<i>In re Kubin</i> , 561 F.3d 1351 (Fed. Cir. 2009)	A claimed polynucleotide would have been obvious over the known protein that it encodes where the skilled artisan would have had a reasonable expectation of success in deriving the claimed polynucleotide using standard biochemical techniques, and the skilled artisan would have had a reason to try to isolate the claimed polynucleotide. <i>KSR</i> applies to all technologies, rather than just the “predictable” arts.
<i>Takeda Chem. Indus. v. Alphapharm Pty., Ltd.</i> , 492 F.3d 1350 (Fed. Cir. 2007)	A claimed compound would not have been obvious where it was not obvious to try to obtain it from a broad range of compounds, any one of which could have been selected as the lead compound for further investigation, and the prior art taught away from using a particular lead compound, and there was no predictability or reasonable expectation of success in making the particular modifications necessary to transform the lead compound into the claimed compound.
<i>Ortho-McNeil Pharm., Inc. v. Mylan Labs, Inc.</i> , 520 F.3d 1358 (Fed. Cir. 2008)	Where the claimed anticonvulsant drug had been discovered somewhat serendipitously in the course of research aimed at finding a new antidiabetic drug, it would not have been obvious to try to obtain a claimed compound where the prior art did not present a finite and easily traversed number of potential starting compounds, and there was no apparent reason for selecting a particular starting compound from among a number of unpredictable alternatives.
<i>Bayer Schering Pharma A.G. v. Barr Labs., Inc.</i> , 575 F.3d 1341 (Fed. Cir. 2009)	A claimed compound would have been obvious where it was obvious to try to obtain it from a finite and easily traversed number of options that was narrowed down from a larger set of possibilities by the prior art, and the outcome of obtaining the claimed compound was reasonably predictable.
<i>Sanofi-Synthelabo v. Apotex, Inc.</i> , 550 F.3d 1075 (Fed. Cir. 2008)	A claimed, isolated stereoisomer would not have been obvious where the claimed stereoisomer exhibits unexpectedly strong therapeutic advantages over the prior art racemic mixture without the correspondingly expected toxicity, and the resulting properties of the enantiomers separated from the racemic mixture were unpredictable.

30. Prior to *KSR*, the Federal Circuit had consistently ruled that “obvious-to-try” was not a legitimate test of patentability. *In re Fine*, 837 F.2d 1071, 1075 (Fed. Cir. 1988). *KSR* held that the Federal Circuit had been too rigid for precluding “obvious-to-try” considerations. *KSR*, 550 U.S. at 402.

Case	Teaching Point
<i>Rolls-Royce, PLC v. United Techs. Corp.</i> , 603 F.3d 1325 (Fed. Cir. 2010)	An obvious-to-try rationale may be proper when the possible options for solving a problem were known and finite. However, if the possible options were not either known or finite, then an obvious-to-try rationale cannot be used to support a conclusion of obviousness.
<i>Perfect Web Techs., Inc. v. InfoUSA, Inc.</i> , 587 F.3d 1324 (Fed. Cir. 2009)	Where there were a finite number of identified, predictable solutions and there is no evidence of unexpected results, an obvious-to-try inquiry may properly lead to a legal conclusion of obviousness. Common sense may be used to support a legal conclusion of obviousness so long as it is explained with sufficient reasoning.

Table 14.8
Consideration of Evidence

Case	Teaching Point
<i>PharmaStem Therapeutics, Inc. v. ViaCell, Inc.</i> , 491 F.3d 1342 (Fed. Cir. 2007)	Even though all evidence must be considered in an obviousness analysis, evidence of nonobviousness may be outweighed by contradictory evidence in the record or by what is in the specification. Although a reasonable expectation of success is needed to support a case of obviousness, absolute predictability is not required.
<i>In re Sullivan</i> , 498 F.3d 1345 (Fed. Cir. 2007)	All evidence, including evidence rebutting a prima facie case of obviousness, must be considered when properly presented.
<i>Hearing Components, Inc. v. Shure Inc.</i> , 600 F.3d 1357 (Fed. Cir. 2010)	Evidence that has been properly presented in a timely manner must be considered on the record. Evidence of commercial success is pertinent where a nexus between the success of the product and the claimed invention has been demonstrated.
<i>Asyst Techs., Inc. v. Emtrak, Inc.</i> , 544 F.3d 1310 (Fed. Cir. 2008)	Evidence of secondary considerations of obviousness such as commercial success and long-felt need may be insufficient to overcome a prima facie case of obviousness if the prima facie case is strong. An argument for nonobviousness based on commercial success or long-felt need is undermined when there is a failure to link the commercial success or long-felt need to a claimed feature that distinguishes over the prior art.

14.3.6 Inventorship

The Patent Act requires that the patent application list all of the inventors. This section discusses who qualifies as an “inventor,” the legal effect of that determination, and how the question arises in litigation.

14.3.6.1 Inventive Entities

Section 116 requires each inventor to apply jointly for a patent on their invention. The statute does not define inventor. Instead, it suggests that multiple people can be joint inventors even if (1) they did not work together in the same space or at the same time, (2) they made unequal contributions to the invention, or (3) they did not contribute to all of the claims of the patent.

For a person to be a joint inventor, they have to contribute to the “conception” of the invention. Testing the invention to make sure it works is not sufficient. See *Burroughs Wellcome Co. v. Barr Labs., Inc.*, 40 F.3d 1223 (Fed. Cir. 1994). Although § 116 does not require that all coinventors work at the same time or in the same place, there must be some collaborative effort. See *Kimberly-Clark Corp. v. Proctor & Gamble Distrib. Co.*, 973 F.2d 911 (Fed. Cir. 1992).

An “inventive entity” is the group of inventors behind any given patent. An inventive entity can be a lone inventor A, or it can be a group, for example, A, B, and C. The inventive entity in these two situations is different, despite sharing an inventor. The significance of this difference requires understanding the various statutory rules governing patent validity. Some rules, like § 102(a)’s novelty bar and § 103’s nonobviousness requirement, only invalidate a claim based on prior art attributable to other inventive entities. This seems logical when the other inventive entity is a competitor or stranger, but note that the solo work of inventive entity A is distinct from the work of inventive entity A, B, and C. For an application of this principle, see *In re O’Farrell*, 853 F.2d 894 (Fed. Cir. 1988).

14.3.6.2 Default Rights of Owners

The question of inventorship often arises because inventors receive a potentially powerful and valuable set of rights in their patents. Each inventor is a co-owner of the patent and may freely grant nonexclusive licenses. Alleged infringers have exploited this technicality by searching for an unlisted coinventor of any of the claims of the patent and obtaining a license from them. See, e.g., *Ethicon, Inc. v. U.S. Surgical Corp.*, 135 F.3d 1456 (Fed. Cir. 1998). Additionally, each joint inventor may freely practice the invention without accounting to the other inventors. See § 262.

In general, companies avoid “rogue” inventor problems by obtaining assignment agreements from everyone they employ. The construction and validity of these assignment agreements depend on state contract law, introducing a choice-of-law wrinkle to patent litigation. Some research institutions are more lax in binding researchers and may not have comprehensive assignment agreements. Such contexts, like a university research setting or a collaborative industry meeting, can give rise to knotty inventorship disputes.

14.3.6.3 Correction of Inventorship

The district court can order corrections to address errors in inventorship. § 256. The Federal Circuit has interpreted this provision broadly, allowing for wide-ranging correction of inventorship. See *Stark v. Advanced Magnetics, Inc.*, 119 F.3d 1551 (Fed. Cir. 1997). The Federal Circuit was careful to note, however, that any

“mistakes” in inventorship designed to avoid the problems created by misaligned inventive entities discussed above could support a finding of “inequitable conduct” and render the patent unenforceable.

14.4 Enforcement: Infringement, Defenses, and Remedies

The second major aspect of most patent litigations relates to the determination of whether infringement has occurred or will occur. Unlike the validity determination—in which the alleged infringer bears the burden of proof (as a result of the presumption of validity)—the patentee bears the burden of proving infringement by a preponderance of the evidence. The alleged infringer then has the opportunity to assert a broad range of legal and equitable defenses. The final aspect of most patent litigations concerns remedies—injunctive relief, damages (including the possibility of enhanced damages), and attorneys’ fees.

14.4.1 Infringement

14.4.1.1 Section 271

Section 271 defines patent liability to include both direct and indirect infringement. Direct infringement exists where an individual violates one of the exclusive rights granted to the patentee under § 271(a). Indirect infringement occurs where a person induces infringement under § 271(b) or contributes to infringement under § 271(c). In either case, the patent holder bears the burden of proving infringement by a preponderance of the evidence. See *Centricut, LLC v. Esab Grp., Inc.*, 390 F.3d 1361, 1367 (Fed. Cir. 2004).

14.4.1.2 Direct Infringement

A person is liable for direct infringement if he “without authority makes, uses, offers to sell, or sells any patented invention, within the United States or imports into the United States any patented invention during the term of the patent therefore.” § 271(a). An accused infringer’s intent is immaterial, as patent infringement is a strict liability offense.

14.4.1.3 Indirect Infringement

Indirect infringement covers conduct by a person who assists or supports another’s direct infringement of a patented invention. Direct infringement must be established as a predicate for each act of indirect infringement. See *Dynacore Holding Corp. v. U.S. Philips Corp.*, 363 F.3d 1263, 1272 (Fed. Cir. 2004) (“Indirect infringement . . . can only arise in the presence of direct infringement, though the direct infringer is typically someone other than the defendant accused of indirect infringement.”). Both the direct infringer and indirect infringer are jointly and severally liable for the infringement.

The Patent Act recognizes both inducement (§ 271(b)) and contributory infringement (§ 271(c)). A third theory of indirect infringement, whereby multiple parties are conjoined in order to prove that all of the steps of a patented process were practiced, was rejected by the Supreme Court in *Akamai Techs., Inc. v. Limelight Networks, Inc.*, 134 S. Ct. 2111 (2014).

14.4.1.3.1 Inducement

Section 271(b) provides that “[w]hoever actively induces infringement of a patent shall be liable as an infringer.” A finding of inducement requires that a patent owner establish evidence of culpable conduct directed toward encouraging another’s infringement. “[I]nduced infringement under § 271(b) requires knowledge [by the inducer] that the induced acts constitute patent infringement.” *Global-Tech Appliances, Inc. v. SEB S.A.*, 131 S. Ct. 2060, 2068 (2011). Thus, the inducer must have “actively and knowingly aid[ed] and abet[ted] another’s direct infringement.” *Water Techs. Corp. v. Calco, Ltd.*, 850 F.2d 660, 668 (Fed. Cir. 1988) (emphasis in original) (noting that “[a]lthough section 271(b) does not use the word ‘knowing,’ the case law and legislative history uniformly assert such a requirement”).

To satisfy the knowledge requirement, the patentee must show that the inducer had actual or constructive knowledge of the patent, *see Insituform Techs., Inc. v. Cat Contracting, Inc.*, 161 F.3d 688, 695 (Fed. Cir. 1998), or acted with “willful blindness.” *Global-Tech*, 131 S. Ct. at 2070–71. Under the doctrine of “willful blindness,” the inducer must have: (1) subjectively believed that there was a high probability of infringement; and (2) taken deliberate actions to avoid learning of that fact. *Id.* at 2070.

Regarding requisite specific intent, the Federal Circuit commented that “it is clear that a good-faith belief of noninfringement is relevant evidence that tends to show that an accused inducer lacked the intent required to be held liable for induced infringement.” *Commil USA, LLC v. Cisco Sys., Inc.*, 720 F.3d 1361, 1367–68 (Fed. Cir. 2013). The same standard does not, however, apply to a good-faith belief that a patent is invalid. In *Commil USA, LLC v. Cisco Sys., Inc.*, 135 S. Ct. 1920 (2015), the Supreme Court ruled that because induced infringement and validity are separate issues and have separate defenses under the Patent Act, belief regarding validity cannot negate § 271(b)’s scienter requirement of “actively induce[d] infringement.”

Inducement liability often arises from supplier/customer relationships. A finding that a single party is responsible for direct infringement under § 271(a) is required before any party can be liable for inducement under § 271(b). Thus, a single party must either have performed every step of the patent, or directed or controlled others who performed them. *See Limelight Networks, Inc. v. Akamai Techs. Inc.*, 134 S. Ct. 2111 (2014).

Section 298, added by the AIA, provides that an accused infringer’s failure to obtain or present advice of counsel may not be used to prove that the accused infringer intended to induce infringement. AIA § 17. Section 298 is applicable to patents issued on or after September 16, 2012.

14.4.1.3.2 Contributory Infringement

Section 271(c) imposes liability under the following circumstances:³¹

[1] Whoever offers to sell or sells within the United States or imports into the United States a component of a patented machine, manufacture, combination or composition, or a material or apparatus for use in practicing a patented process, [2] constituting a material part of the invention, [3] knowing the same to be especially made or especially adapted for use in an infringement of such patent, [4] and not a staple article or commodity of commerce suitable for substantial noninfringing use, [5] shall be liable as a contributory infringer.

The alleged contributory infringer must have knowledge of the patent. *See Aro Mfg. Co. v. Convertible Top Replacement Co.*, 377 U.S. 476, 488 (1964). Element [4] serves as an important defense, immunizing the sale of staple articles of commerce, that is, products that have substantial noninfringing uses. Thus, absent evidence of inducing conduct, sellers of nonpatented goods are shielded from liability unless the good “has no commercial use except in connection with . . . [the] patented invention.” *Dawson Chem. Co. v. Rohm & Haas Co.*, 448 U.S. 176, 184 (1980).

14.4.1.3.3 Joint Infringement

Patent law has struggled to deal with scenarios in which multiple parties carry out the steps of a claimed method or the elements of a claimed system. The traditional rule in patent law has been that an infringer must practice every limitation of a claim to infringe it. If no single entity practices each step or element, there can be no infringement. Nonetheless, liability can be found where one party controlled or directed each step in a patented process. *See Akamai Techs., Inc. v. Limelight Networks, Inc.*, 134 S. Ct. 2111, 2117 (2014) (holding that “a method’s steps have not all been performed as claimed by the patent unless they are all attributable to the same defendant, either because the defendant actually performed those steps or because he directed or controlled others who performed them”); *Centillion Data Sys., LLC v. Qwest Commc’ns Int’l*, 631 F.3d 1279, 1284 (Fed. Cir. 2011) (holding that direct infringement for “use” of the claimed system is possible where a single party does not physically possess or own some elements of the system, if that party “put[s] the invention into service, i.e., control[s] the system as a whole and obtain[s] benefit from it”).

The Federal Circuit has expanded the scope of direct infringement under § 271(a) in situations to encompass circumstances where

an alleged infringer conditions participation in an activity or receipt of a benefit upon performance of a step or steps of a patented method and establishes the manner or timing of that performance. *Cf. Metro-Goldwyn-Mayer Studios Inc. v. Grokster, Ltd.*, 545 U.S. 913, 930 (2005) (stating that an actor ‘infringes vicariously by profiting from direct infringement’ if that actor has the right and ability to stop or limit the infringement). In those instances, the third party’s actions are attributed to the alleged infringer.

31. The section is reproduced in subdivided form to highlight its essential elements.

er such that the alleged infringer becomes the single actor chargeable with direct infringement.

Whether a single actor directed or controlled the acts of one or more third parties is a question of fact, reviewable on appeal for substantial evidence, when tried to a jury.

Akamai Techs., Inc. v. Limelight Networks, Inc., 797 F.3d 1020, 1023 (Fed. Cir. 2015) (en banc) (following remand). In addition, the Federal Circuit held that participants in a joint enterprise can be charged with the acts of the other for purposes of direct infringement. *Id.* at 1023 (citing Restatement (Second) of Torts § 491 cmt. b (“The law . . . considers that each is the agent or servant of the others, and that the act of any one within the scope of the enterprise is to be charged vicariously against the rest.”)).

A joint enterprise requires proof of four elements: “(1) an agreement, express or implied, among the members of the group; (2) a common purpose to be carried out by the group; (3) a community of pecuniary interest in that purpose, among the members; and (4) an equal right to a voice in the direction of the enterprise, which gives an equal right of control.” Restatement (Second) of Torts § 491 cmt. c. As with direction or control, whether actors entered into a joint enterprise is a question of fact, reviewable on appeal for substantial evidence. 797 F.3d at 1023 (citing Restatement (Second) of Torts § 491 cmt. c).

14.4.1.4 Infringement Analysis

Infringement analysis involves two steps: (1) claim construction and (2) comparison of properly construed claims with the accused product or process. *See Cybor Corp. v. FAS Techs., Inc.*, 138 F.3d 1448, 1454 (Fed. Cir. 1998) (en banc). The first step, interpreting the claims, was covered in Chapter 5. We now turn to the second step.

14.4.1.4.1 Literal Infringement

Literal infringement exists when the accused product or process contains each and every limitation recited in a claim, “*i.e.* when the properly construed claim reads on the accused device exactly.” *Cole v. Kimberly-Clark Corp.*, 102 F.3d 524, 532 (Fed. Cir. 1996). Accordingly, there can be no literal infringement if the accused product or process lacks any claim limitation. The standards for anticipation under § 102 and literal infringement are identical. As the Federal Circuit has observed, “that which would literally infringe if later anticipates if earlier.” *Bristol-Myers Squibb Co. v. Ben Venue Labs., Inc.*, 246 F.3d 1368, 1378 (Fed. Cir. 2001).

One special category of literal claim interpretation relates to so-called means plus function or functional claim formats.

14.4.1.4.1.1 Interpreting the Literal Scope of Means-Plus-Function Claims (§ 112(f))

In *Halliburton Oil Well Cementing Co. v. Walker*, 329 U.S. 1 (1946), the patentee had claimed an apparatus for measuring the depth of oil wells using functional claim

limitations: “means communicating with said well for creating a pressure pulse” and “echo receiving means.” *Id.* at 9 n.7. The patentee did not want to limit itself to a specific means, and instead sought to define the claim through the functions sought. Such claiming formats were relatively common in patent practice. Nonetheless, the Supreme Court invalidated the claims for failing to reveal specific structures. *Id.* at 11–14. The Court believed that such claims were overbroad, indefinite, and could discourage experimentation by others.

The patent bar promptly persuaded Congress to remove the cloud over the many functional claims in issued and pending patents the Halliburton decision created. The provision, which is now codified in § 112(f), authorizes the use of the means-plus-function claim format while limiting the scope of such claims to all embodiments set forth in the specification “and equivalents thereof.” The determination of “equivalents thereof” is based on the state of technology as of the date that the patent issues. This characterization of “equivalents” differs from the meaning under the “doctrine of equivalents.” *See* § 14.4.1.4.2.

14.4.1.4.1.1 Determining Whether a Claim Limitation Is Governed by § 112(f)

The use of the term “means” in a claim limitation typically implies that the inventor used the “means-plus-function” claim format, which invokes the associated statutory limits on the literal scope of that claim limitation. *See Greenberg v. Ethicon Endo-Surgery, Inc.*, 91 F.3d 1580, 1584 (Fed. Cir. 1996); *cf. Williamson v. Citrix Online LLC*, 2015 U.S. App. LEXIS 10082, 2015 WL 3687459 at *7 (Fed. Cir. 2015) (en banc) (revoking prior cases holding that there is a strong, but rebuttable, presumption that a term lacking the word “means” does not invoke § 112(f)); § 5.2.3.5.1. Nonetheless, this implication does not apply where the claim language itself provides the structure that performs the recited function. *See Phillips v. AWH Corp.*, 415 F.3d 1303 (Fed. Cir. 2005) (en banc) (finding that a claim limitation stating “means disposed inside the shell for increasing its load bearing capacity comprising internal steel baffles” provides the relevant structure (“internal steel baffles”) and hence is not limited to the embodiments in the specification and equivalents thereof); *Cole v. Kimberly-Clark Corp.*, 102 F.3d 524, 531 (Fed. Cir. 1996) (finding that use of the phrase “perforation means” does not invoke § 112(f)).

Conversely, merely because a claim does not include the word “means” does not prevent a claim limitation from being construed as a means-plus-function limitation. The *Williamson* decision holds that

[t]he standard is whether the words of the claim are understood by persons of ordinary skill in the art to have a sufficiently definite meaning as the name for structure. *Greenberg*, 91 F.3d at 1583. When a claim term lacks the word “means,” the presumption can be overcome and § 112[(f)] will apply if the challenger demonstrates that the claim term fails to “recite sufficiently definite structure” or else recites “function without reciting sufficient structure for performing that function.” *Watts*, 232 F.3d at 880. The converse presumption remains unaffected: “use of the word ‘means’ creates a presumption that § 112[(f)] applies.” *Personalized Media*, 161 F.3d at 703.

Williamson v. Citrix Online LLC, 792 F.3d. 1339, 1349 (2015). The focus is on the claim language as a whole, not just the isolated term that is akin to “means.” *Id.* at *8. Generic terms such as “mechanism,” “element,” “device” and other such terms that do not connote sufficiently definite structure in the context of the overall claim are tantamount to stating “means,” and therefore may be construed pursuant to 112(f) if nothing else in the claim provides sufficient structure. *Id.* at *8. Whether a claim invokes § 112(f) is decided on a limitation-by-limitation basis looking to the patent and the prosecution history. See *Cole*, 102 F.3d at 531.

14.4.1.4.2 Nonliteral Infringement—The Doctrine of Equivalents

The doctrine of equivalents allows for a finding of infringement where the accused product or process is close to the patented invention, but does not literally infringe. The doctrine of equivalents evolved in response to the concern that an “unscrupulous copyist” could avoid literal infringement of a patented invention by making insubstantial changes to the invention. *Graver Tank & Mfg. Co. v. Linde Air Prods. Co.*, 339 U.S. 605, 607–08 (1950). The doctrine is judge-made and has long served to provide courts some leeway to ensure that insubstantial variations do not destroy the value of patents. The doctrine of equivalents has increasingly come under scrutiny on the grounds that it introduces tremendous uncertainty into the scope of patents and makes it difficult for competitors to determine where they can legitimately tread. As a result, the Supreme Court and the Federal Circuit have revisited the contours of this doctrine frequently over the past decade. The process of judicial tinkering appears to have come to rest.

There are two tests for determining equivalence: (1) the function-way-result test and (2) the insubstantial differences test. The use of either test is case-dependent. See *Warner-Jenkinson Co. v. Hilton Davis Chem. Co.*, 520 U.S. 17, 40 (1997). Under the function-way-result test, an accused element is equivalent to a claim limitation “if it performs substantially the same function in substantially the same way to obtain the same result.” *Graver Tank*, 339 U.S. at 608 (quoting *Sanitary Refrigerator Co. v. Winters*, 280 U.S. 30, 42 (1929)). Under this test, a finding of equivalence requires that all three prongs be satisfied. Under the insubstantial differences test, equivalence exists where the differences between the element in the accused product or process and the claim limitation are insubstantial. See Kenneth D. Bassinger, *Unsettled Expectations in Patent Law: Festo and the Moving Target of Claim Equivalence*, 48 How. L.J. 685, 695 (2005). Under either test, nonliteral infringement is a question of fact for the jury to decide. See *Cook Biotech Inc. v. Acell, Inc.*, 460 F.3d 1365, 1373 (Fed. Cir. 2006). The doctrine of equivalents determination is judged on the state of technology as of the time of the infringement, not (as in the case of means-plus-function claims) as of the time the patent issued.

14.4.1.4.2.1 Limiting Principles

While the doctrine of equivalents is a question of fact, the courts have developed various legal doctrines that limit its applicability: (1) the all-elements rule, along with

the claim vitiation corollary; (2) prosecution history estoppel, along with the specific exclusion corollary; (3) the prior art rule; and (4) the public dedication rule. These limiting doctrines are not mutually exclusive—the patentee must satisfy all of them to establish infringement under the doctrine of equivalents.

14.4.1.4.2.1.1 The All-Elements (All-Limitations) Rule

The all-elements rule³² provides that the test for equivalence under the doctrine of equivalents must be applied on an element-by-element (or limitation-by-limitation) basis. A finding of infringement therefore requires that the accused product or process contain each claim limitation or its equivalent. Under the all-elements rule, the trier of fact performs an equivalence analysis to determine whether each claim limitation exists in the accused product or process either literally or as an equivalent. However, if no reasonable jury could find an equivalent element in the accused product or process to the claim limitation, the court must grant summary judgment as to noninfringement. *Warner-Jenkinson Co. v. Hilton Davis Chem. Co.*, 520 U.S. 17, 39 n.8 (1997).

14.4.1.4.2.1.1.1 Claim Vitiation

The claim vitiation doctrine is a corollary of the all-elements rule: an accused device cannot be infringing if it would effectively vitiate (or eliminate) any claim limitation. See *Freedman Seating Co. v. Am. Seating Co.*, 420 F.3d 1350, 1358 (Fed. Cir. 2005). The Federal Circuit has applied the claim vitiation rule in varying ways, leading to somewhat unpredictable results. See Daniel H. Shulman & Donald W. Rupert, “Vitiating” the Doctrine of Equivalents: A New Patent Law Doctrine, 12 Fed. Cir. B.J. 457 (2003). In *Cadence Pharmaceuticals Inc. v. Exela PharmSci Inc.*, 780 F.3d 1364, 1371 (Fed. Cir. 2015), the Federal Circuit clarified that “‘vitiation’ is not an exception or threshold determination that forecloses resort to the doctrine of equivalents, but is instead a legal conclusion of a lack of equivalence based on the evidence presented and the theory of equivalence asserted.” The court explained that equivalence should not depend on “labels like ‘vitiation’ . . . but on the proper assessment of the language of the claimed limitation and the substantiality of whatever relevant differences may exist in the accused structure.”

14.4.1.4.2.1.2 Prosecution History Estoppel

Prosecution history estoppel can preclude a patent holder from using the doctrine of equivalents to reclaim subject matter relinquished expressly or by operation of law during patent prosecution. See *Eagle Comtronics, Inc. v. Arrow Commc’n*

32. The Federal Circuit prefers to use “limitation” when referring to claim language and “element” when referring to the accused product. *Festo Corp. v. Shoketsu Kinzoku Kabushiki Co.*, 234 F.3d 558, 563 n.1 (Fed. Cir. 2000). Along those lines, the all-elements rule is also known as the all-limitations rule. *Ethicon Endo-Surgery, Inc. v. U.S. Surgical Corp.*, 149 F.3d 1309, 1317 n.1 (Fed. Cir. 1998).

Labs., Inc., 305 F.3d 1303, 1315 (Fed. Cir. 2002). Prosecution history estoppel is most often applied where a patent applicant amended or canceled a claim that the patent examiner rejected as unpatentable in light of prior art. Whether prosecution history estoppel applies in a particular case is a question of law. See *Panduit Corp. v. Hellermanntyton Corp.*, 451 F.3d 819, 826 (Fed. Cir. 2006).

In *Festo Corp. v. Shoketsu Kinzoku Kabushiki Co.*, 535 U.S. 722 (2002), the Supreme Court adopted a rebuttable presumption that amendments made to narrow a claim limitation foreclose later stretching of that limitation to reach an accused technology under the doctrine of equivalents. The patentee can rebut this presumption under three scenarios: (1) the equivalent was unforeseeable to a person having ordinary skill in the art at the time of the amendment; (2) the rationale for the amendment was no more than tangentially related to the equivalent at issue; or (3) another reason suggesting that the patentee could not reasonably be expected to have described the alleged equivalent. *Id.* at 740–41. Table 14.9 summarizes guidelines outlined by the Federal Circuit for applying the three rebuttal criteria. See *Festo Corp. v. Shoketsu Kinzoku Kabushiki Co.*, 344 F.3d 1359, 1368–70 (Fed. Cir. 2003) (en banc).

Table 14.9
Rebuttal Criteria for Presumptive *Festo* Bar

Rebuttal Criteria	Application	Focus of Inquiry	Evidence the Court May Consider
The equivalent was unforeseeable at the time of the application.	Unforeseeable equivalent: later-developed technologies or technology unknown in the relevant art. Foreseeable equivalent: old technology or equivalent was known in the prior art in the relevant field of the invention.	Underlying factual issues such as the state of the art and understanding of one skilled in the art at the time of the amendment.	Expert testimony and other extrinsic evidence relating to relevant factual inquiries.
The rationale for the amendment was no more than tangentially related to the equivalent at issue.	Tangential means peripheral or not directly relevant Not tangential: amendment made to avoid prior art containing the alleged equivalent.	Patentee’s objective apparent reason for the narrowing amendment, including the context in which the amendment was made.	Prosecution history record and no additional evidence except when expert testimony is necessary for interpretation of that record.

Rebuttal Criteria	Application	Focus of Inquiry	Evidence the Court May Consider
Another reason suggesting that the patentee could not reasonably be expected to have described the alleged equivalent.	Another reason: shortcomings in language.	[No cases yet on point.]	Should be limited to prosecution history record.

14.4.1.4.2.1.2.1 Specific Exclusion

The specific exclusion principle is a corollary to the doctrine of prosecution history estoppel. It provides that a patentee cannot use the doctrine of equivalents to reclaim subject matter which he clearly excluded. *SciMed Life Sys., Inc. v. Advanced Cardiovascular Sys., Inc.*, 242 F.3d 1337, 1347 (Fed. Cir. 2001). A patent may specifically exclude a proposed equivalent from the scope of the claimed invention either implicitly or explicitly. The rule ensures that the public may rely on clear disclaimers in the patent to conclude that the patentee did not seek patent rights for this excluded subject matter.

The specific exclusion doctrine applies where the patentee clearly disclaims subject matter from the scope of the claimed invention in the specification or the claims. Cases involving specific exclusion in the specification focus on explicit disclaimers, such as where the patentee criticizes the equivalent or requires that the invention contain the specific element claimed. *See Gaus v. Conair Corp.*, 363 F.3d 1284, 1291 (Fed. Cir. 2004); *SciMed*, 242 F.3d at 1345. Specific exclusion is rarely applied on the basis of a claim, but where the patentee claims one option in a binary choice setting, specific exclusion precludes the patent holder's assertion that the other option is equivalent. *See Senior Techs., Inc. v. R.F. Techs. Inc.*, 76 F. App'x 318, 321 (Fed. Cir. 2003). The binary choice setting does not simply involve the negation of a claim limitation (i.e., "suede" versus "not suede" or "blue" versus "not blue"), but requires that the claim limitation be one of only two options.

14.4.1.4.2.1.3 Prior Art Rule

A third limiting principle of nonliteral infringement analysis, the prior art rule, provides that a patentee may not use the doctrine of equivalents to obtain coverage of subject matter in the prior art, that is, "coverage which he could not lawfully have obtained from the USPTO by literal claims." *Wilson Sporting Goods Co. v. David Geoffrey & Assocs.*, 904 F.2d 677, 683–84 (Fed. Cir. 1990). Accordingly, an accused infringer who merely practices the prior art cannot infringe under the doctrine of equivalents. This principle is applied by constructing a hypothetical claim based on the accused technology. *See id.* at 684. If the USPTO could have allowed the hypothetical claim over the prior art (i.e., if the prior art did not anticipate or render the hypothetical claim obvious, *Abbott Labs. v. Dey, L.P.*, 287 F.3d 1097, 1105–06 (Fed. Cir. 2002)), the prior art does not preclude infringement under the doctrine of

equivalents. The patent holder bears the burden of proving that the range of equivalents sought does not cover the prior art. See *Wilson Sporting Goods*, 904 F.2d at 685. This determination is a question of law. See *id.* at 683.

14.4.1.4.2.1.4 The Public Dedication Rule

The public dedication rule (or disclosure-dedication rule) provides that a patent holder cannot invoke the doctrine of equivalents to recapture subject matter disclosed but not claimed in a patent. See *Johnson & Johnston Assocs. Inc. v. R.E. Serv. Co.*, 285 F.3d 1046, 1054 (Fed. Cir. 2002) (en banc) (per curiam). The Federal Circuit stated that to hold otherwise would “conflict with the primacy of the claims in defining the scope of the patentee’s exclusive right.” *Id.* (quoting *Sage Prods. Inc. v. Devon Indus., Inc.*, 126 F.3d 1420, 1424 (Fed. Cir. 1997)). The public dedication rule derives from and promotes the patent system’s notice function. The test for determining whether a disclosure has been dedicated to the public is whether “one of ordinary skill in the art can understand the unclaimed disclosed teaching upon reading the written description.” *PSC Comput. Prods., Inc. v. Foxconn Int’l, Inc.*, 355 F.3d 1353, 1360 (Fed. Cir. 2004). Like prosecution history estoppel, the public dedication rule is a question of law. See *Toro Co. v. White Consol. Indus., Inc.*, 383 F.3d 1326, 1331 (Fed. Cir. 2004). Patentees are free to broaden the scope of their patent under the broadening reissue provision, § 251, for up to two years following issuance. See § 14.2.5.4.2.

14.4.1.4.2.2 Interpreting the Nonliteral Scope of Means-Plus-Function Claims

The question arises whether means-plus-function claims are entitled to one or two stretches for “equivalents”—one as a part of literal infringement analysis under § 112(f) (to reach “equivalents thereof” relating to embodiments set forth in the specification) and a second under the doctrine of equivalents. Since the § 112(f) literal “equivalents” analysis is based on the state of technology as of the time the patent issues, the doctrine of equivalents provides a second stretch to the extent that the accused device employs “after-arising” technology—means that were not known in the art at the time that the patent issued. See *Al-Site Corp. v. VSI Int’l, Inc.*, 174 F.3d 1308, 1320 (Fed. Cir. 1999).

Even with regard to technology that was known as of the time that the patent issued, the patentee is entitled to additional scope under the doctrine of equivalents to the extent that the function of the accused device is substantially the same as the function of the claimed invention. See *id.* at 1320–21; see also *WMS Gaming v. Int’l Game Tech.*, 184 F.3d 1339, 1353 (Fed. Cir. 1999). This is because § 112(f) requires that the function of the accused element be identical to the function of the claim limitation, whereas the doctrine of equivalents is broader—allowing substantially similar function.

Nonetheless, the patentee cannot invoke the doctrine of equivalents to reach a substantially similar “structure, material, or act” that did not fall within the scope of the § 112(f) “equivalents thereof” with regard to technology that was known as of the

time that the patent issued. The Patent Act will not permit an “equivalent of an equivalent” by applying both § 112(f) and the doctrine of equivalents to the structure of a given claim element with regard to technology that the patent draftsman was fully capable of capturing when preparing the application. *Al-Site*, 174 F.3d at 1320 n.2; *Chiuminatta Concrete Concepts, Inc. v. Cardinal Indus., Inc.*, 145 F.3d 1303, 1310–11 (Fed. Cir. 1998).

14.4.1.4.3 The Reverse Doctrine of Equivalents

The reverse doctrine of equivalents is an equitable doctrine designed “to prevent unwarranted extension of the claims beyond a fair scope of the patentee’s invention.” *Scripps Clinic & Research Found. v. Genentech, Inc.*, 927 F.2d 1565, 1581 (Fed. Cir. 1991). More than a century ago, the Supreme Court recognized that there may be circumstances in which an accused device that literally infringes a patent should nonetheless be excused from liability because it substantially differs in operative principle and results. Although the so-called reverse doctrine of equivalents has rarely been found, it nonetheless continues to be raised. In *Boyden Power-Brake Co. v. Westinghouse*, 170 U.S. 537 (1898), George Westinghouse had invented a train brake that used a central reservoir of compressed air for stopping power in 1869. *Id.* at 545–46. Further advances in his design, primarily the addition of an air reservoir in each brake cylinder, resulted in a brake that was patented in 1887. *Id.* at 558–60. An improvement on this 1887 brake, invented by George Boyden, added an ingenious mechanism for pushing compressed air into the brake piston from both the central reservoir and a local reservoir in each brake cylinder. (Westinghouse’s brake required a complicated series of passageways to supply air from the two sources.) With the added stopping power of the Boyden brake, engineers could safely operate the increasingly long trains of the late nineteenth century.

The Westinghouse patent included a claim for “the combination of a main air-pipe, an auxiliary reservoir, a brake-cylinder, a triple valve [the device that coordinated the airflows from the main reservoir and the individual brake reservoir] and an auxiliary-valve device, actuated by the piston of the triple-valve . . . for admitting air in the application of the brake.” *Id.* at 553–54. The Court noted that the literal wording of the Westinghouse patent could be read to cover Boyden’s brake since it included a “triple valve.” But it refused to find infringement on the ground that Boyden’s device was a significant contribution that took the invention outside the equitable bounds of the patent, explaining:

a charge of infringement is sometimes made out, though the letter of the claims be avoided . . . [t]he converse is equally true. The patentee may bring the defendant within the letter of his claims, but if the latter has so far changed the principle of the device that the claims of the patent, literally construed, have ceased to represent his actual invention, he is as little subject to be adjudged an infringer as one who has violated the letter of a statute has to be convicted, when he has done nothing in conflict with its spirit and intent.

Id. at 562.

The reverse doctrine of equivalents was recognized—but not applied—once again by the Supreme Court in *Graver Tank & Mfg. Co. v. Linde Air Prods. Co.*, 339 U.S. 605, 608–609 (1950). But since 1898, no case has squarely applied the doctrine to excuse infringement. According to the Federal Circuit, “because products on which patent claims are readable word for word often are in fact the same, perform the same function in the same way, and achieve the same result, as the claimed invention, a defense based on the reverse doctrine of equivalents is rarely offered.” *SRI Int’l v. Matsushita Elec. Corp. of Am.*, 775 F.2d 1107, 1123 n.19 (Fed. Cir. 1985); *See Monsanto Co. v. Mycogen Plant Sci., Inc.*, 61 F. Supp. 2d 133, 187–88 (D. Del. 1999) (granting JMOL overturning jury’s exoneration of accused infringer under reverse doctrine of equivalents). Indeed, the Federal Circuit has observed that “[t]he reverse doctrine of equivalents is rarely applied, and this court has never affirmed a finding of noninfringement under the reverse doctrine of equivalents.” *See Roche Palo Alto LLC v. Apotex, Inc.*, 531 F.3d 1372, 1378 (Fed. Cir. 2008) (citing *Tate Access Floors, Inc. v. Interface Architectural Resources, Inc.*, 279 F.3d 1357 (Fed. Cir. 2002)).

14.4.1.5 Extraterritorial Infringement

14.4.1.5.1 Manufacturing Components Within the United States for Assembly Abroad—§ 271(f)

The rights conferred under patent law generally apply only to inventions made, used, sold, or imported into the United States. § 271(a). After the Supreme Court held that there could be no liability for shipping the components of a patented device outside of the United States for purposes of assembly abroad, *see Deepsouth Packing Co. v. Laitram Corp.*, 406 U.S. 518 (1972), Congress added § 271(f) to extend liability for supplying unassembled “components” from the United States for “combination” outside the United States, where the same combination would infringe a patent if it occurred within the United States. The two prongs of infringement under § 271(f) are similar to active inducement and contributory infringement found in § 271(b) and (c).

Applying § 271(f) poses several challenges in the digital age. One particularly thorny issue has been the meaning of “component.” For example, a “component” does not include the supply of blueprints, plans, or instructions. *Pellegrini v. Analog Devices, Inc.*, 275 F.3d 1113 (Fed. Cir. 2004). Nor does it include software; instead only a tangible, computer-readable medium like a CD can be a “component.” *See Microsoft Corp. v. AT&T Corp.*, 550 U.S. 437 (2007). The term “supply” has also been controversial. In *Microsoft*, the Court held that to “supply” a component from the United States means to ship it from the United States; making copies abroad does not constitute “supplying.” *Id.* at 452–53.

Notably, § 271(f) is inapplicable to method claims. *Cardiac Pacemakers, Inc. v. St. Jude Med., Inc.*, 576 F.3d 1348, 1364 (Fed. Cir. 2009) (en banc in relevant part) (“[B]ecause one cannot supply the step of a method, Section 271(f) cannot apply to method or process patents.”). Accordingly, “Section 271(f) does not encompass devices that may be used to practice a patented method.” *Id.* at 1366.

14.4.1.5.2 Importing Products Made Using Patented Processes—§ 271(g)

Section 271(g) was also added in the 1980s to close a loophole pertaining to products imported into the United States made using patented processes. It establishes liability for importing, making, using, or selling within the United States a nonpatented product made abroad using a process that is patented in the United States. A “product” under subsection (g) must be a manufactured physical article; it does not include intangible information produced or transmitted by a patented process. See *NTP, Inc. v. Research in Motion, Ltd.*, 418 F.3d 1282 (Fed. Cir. 2005). Furthermore, there is no liability if the product is “materially changed by subsequent processes.” § 271(g)(1). The Federal Circuit has held that “in the chemical context a ‘material’ change . . . is a significant change in the compound’s structure and properties.” *Eli Lilly & Co. v. Am. Cyanamid Co.*, 82 F.3d 1568, 1573 (Fed. Cir. 1996).

14.4.2 Defenses

Section 282 of the Patent Act provides for the following defenses:

- (1) Noninfringement, absence of liability for infringement or unenforceability;
- (2) Invalidity of the patent or any claim in suit on any ground specified in part II [of the Patent Act] as a condition for patentability;
- (3) Invalidity of the patent or any claim in suit for failure to comply with any requirement of sections 112 or 251 [of the Patent Act];
- (4) Any other fact or act made a defense by [the Patent Act].

14.4.2.1 Noninfringement

An accused infringer may contend that he does not infringe the asserted patent either literally or under the doctrine of equivalents. Noninfringement exists where the patent holder does not meet the burden of proving infringement by a preponderance of the evidence.

14.4.2.2 Absence of Liability

Even if the accused technology is found to read on the claimed invention, the defendant can prevail by establishing consent, experimental use, or several other legal and equitable defenses.

14.4.2.2.1 Consent or License

An alleged infringer can defend on the ground that the patentee has consented to their use of the technology by, for example, granting a license. A patent license is an agreement or covenant between the patent holder and the licensee stipulating that the patent holder will not sue the licensee for otherwise infringing acts. If such an agreement covers the acts in question, the accused infringer cannot be liable for in-

fringement because his or her acts were not “without authority” as required by § 271(a).

Patent licenses can be express or implied. An implied license arises by acquiescence, conduct, equitable estoppel, or legal estoppel. *Wang Labs., Inc. v. Mitsubishi Elecs. Am., Inc.*, 103 F.3d 1571, 1580 (Fed. Cir. 1997). Such licenses are generally revocable. The existence and scope of licenses are generally governed by state contract law.

14.4.2.2.1.1 First-Sale Doctrine/Exhaustion Principle

Under the first-sale doctrine (sometimes referred to as the exhaustion principle), a form of implied license by operation of law, the first unrestricted sale of a patented product exhausts the patentee’s control over that product, and it can be resold and repaired without implicating the patent owner’s rights. *See Aro Mfg. Co. v. Convertible Top Replacement Co.*, 377 U.S. 476, 484 (1964) (stating that “it is fundamental that sale of a patented article by the patentee . . . carries with it an ‘implied license to use.’”). The line between permitted repair and impermissible reconstruction is not easily determined, resulting in rather vague, context-specific rulings. *See, e.g., Hewlett-Packard Co. v. Repeat-O-Type Stencil Mfg. Co.*, 123 F.3d 1445 (Fed. Cir. 1997). Such issues frequently arise in the context of contributory infringement claims, where the alleged infringer is providing specialized replacement parts.

Contractual restrictions on resale or reuse can provoke patent misuse allegations and antitrust counterclaims. *See Lexmark International, Inc. v. Impression Prods., Inc.*, — F.3d —, 2016 WL 559042 (Fed. Cir. 2016); *Monsanto Co. v. McFarling*, 363 F.3d 1336, 1341 (Fed. Cir. 2004); *Mallinckrodt, Inc. v. Medipart, Inc.*, 976 F.2d 700 (Fed. Cir. 1992); *see also* § 14.4.2.3.2. Unlike other forms of implied licenses, patent exhaustion cannot be disclaimed. Nonetheless, patent exhaustion does not prevent the owner of a patent on a self-replicating product from using contractual restrictions to bar use of self-replicated progeny. Patent exhaustion only applies to “the particular item sold, and not to reproductions” made within the purchaser’s control. *Bowman v. Monsanto Co.*, 133 S. Ct. 1761, 1768 (2013).

Exhaustion is determined on a patent-by-patent, as opposed to a claim-by-claim, basis. *See Keurig, Inc. v. Sturm Foods, Inc.*, 732 F.3d 1370 (Fed. Cir. 2013); *but see id.* at 1375 (O’Malley, J., concurring in the result) (noting that because each patent claim represents a separate invention, patent exhaustion should apply on a claim-by-claim basis).

The doctrine of patent exhaustion applies to method claims and the method patent is exhausted by sale of the item that embodies the method. *See Quanta Comput., Inc. v. LG Elecs., Inc.*, 553 U.S. 617 (2008). Although repair of a patented product that has been sold is permissible, reconstruction of the patented technology crosses the line into the patentee’s “make” right. Furthermore, sale of a component that does not completely practice or embody a patent claim can still exhaust the patent if the product has no substantial noninfringing use or if the component substantially embodies the claim. *See id.*

The Federal Circuit held in *Jazz Photo Corp. v. International Trade Commission*, 264 F.3d 1094 (Fed. Cir. 2001), that where a licensee sells a product outside the U.S.,

such sale does not exhaust the licensor's U.S. patents if that product is subsequently imported and sold in the U.S. The Federal Circuit reaffirmed the *Jazz Photo* rule in *Lexmark International, Inc. v. Impression Products, Inc.*, — F.3d —, 2016 WL 559042 (Fed. Cir. 2016) (en banc) (distinguishing the Supreme Court's holding in *Kirtsaeng v. John Wiley & Sons, Inc.*, 133 S. Ct 1351 (2013), holding that international exhaustion applies under the Copyright Act notwithstanding the importation right).

14.4.2.2.1.2 Shop Right

Based on state law, a “shop right” entitles an employer to use patented technology developed by an employee in the employer's “shop.” See *McElmurry v. Ark. Power & Light Co.*, 995 F.2d 1576, 1580 (Fed. Cir. 1993). An employer has a shop right where it has provided wages, materials, tools, and workspace to finance its employee's invention. An employee's consent, acquiescence, inducement, or assistance to the employer in using the invention without seeking payment or restricting its use also creates a shop right. *Id.* at 1582. The defense is an equitable doctrine. *Schroeder v. Tracor, Inc.*, No. 99-1281, 1999 U.S. App. LEXIS 30386, at *4–5, 1999 WL 1021055 (Fed. Cir. Nov. 5, 1999). To determine whether an employer has a shop right to an invention, courts “look to the totality of the circumstances on a case by case basis and determine whether the facts of a particular case demand, under principles of equity and fairness, a finding that a ‘shop right’ exists.” *McElmurry*, 995 F.2d at 1581–82. A shop right is personal to an employer and cannot be assigned or transferred. See *Francklyn v. Guilford Packing Co.*, 695 F.2d 1158, 1163 (9th Cir. 1983). However, a shop right will pass to the purchaser of the employer's entire business. See *Cal. E. Labs., Inc. v. Gould*, 896 F.2d 400, 402 (9th Cir. 1990).

14.4.2.2.2 Experimental Use Defense

Courts have long recognized a common-law defense of experimental use. The Federal Circuit has, however, interpreted this doctrine quite narrowly, limiting it to uses “for amusement, to satisfy idle curiosity, or for strictly philosophical inquiry.” See *Madey v. Duke Univ.*, 307 F.3d 1351, 1361–62 (Fed. Cir. 2002). If the use has the “slightest commercial implication,” the experimental use defense does not apply. *Id.* at 1362. Additionally, conduct in keeping with the legitimate business of the accused infringer does not qualify for the defense, regardless of the commercial implications. *Id.* Furthermore, whether a user is a profit or nonprofit entity is not determinative. *Id.*

In addition to the common-law doctrine of experimental use, § 271(e) creates a limited experimental use exception for submitting information for regulatory purposes. Adopted in 1984 as part of the Drug Price Competition Act (also known as the Hatch-Waxman Act), § 271(e)(1) provides a safe harbor for using a patented drug in testing before the end of the patent term “solely for uses reasonably related to the development and submission” of regulatory information. Without this safe harbor, a competitor seeking to get advance approval of a generic version of a particular drug would infringe if they tested their alternative before the patent term expired, which would effectively lengthen the patent term by the amount of time nec-

essary to test the generic drug for FDA approval. See *Roche Prods. Inc. v. Bolar Pharm. Co.*, 733 F.2d 858 (Fed. Cir. 1984). While the safe harbor is not so expansive as to include “basic scientific research . . . performed without the intent to develop a particular drug,” its scope has been interpreted broadly to cover drug testing, human clinical trials, and preclinical laboratory testing, or any reasonable research that might be “appropriate to include in a submission to the FDA.” *Merck KGaA v. Integra Lifesciences I, Ltd.*, 545 U.S. 193, 205–06 (2005); see also *Integra Lifesciences I, Ltd. v. Merck KGaA*, 496 F.3d 1334 (Fed. Cir. 2007). In addition to pharmaceuticals, § 271(e)(1) covers experimental testing of medical devices. See *Eli Lilly & Co. v. Medtronic Inc.*, 872 F.2d 402 (Fed. Cir. 1989), *aff’d*, 496 U.S. 661 (1990).

14.4.2.2.3 Prior-Use Right

Section 273 of the Patent Act, added by the First Inventor Defense Act of 1999, provides an infringement defense for an earlier inventor of a business method which was subsequently patented by another. This defense is available if the accused infringer “had, acting in good faith, actually reduced the subject matter to practice at least 1 year before the effective filing date of such patent, and commercially used the subject matter before the effective filing date of such patent.” § 273(b)(1). The party asserting a prior-use defense need not prove that it invented the business method before the patentee in accordance with § 102(g). Section 273(e) limits the transfer of the prior-use right except as “an ancillary and subordinate part of a good-faith assignment or transfer for other reasons of the entire enterprise or line of business to which the defense relates.”

Effective September 16, 2011, to patents issued on or after that date, the AIA expands the scope of prior-use rights to also include “subject matter consisting of a process, or consisting of a machine, manufacture, or composition of matter used in a manufacturing or other commercial process.” AIA § 5. For this defense to apply, the prior use must have been a prior commercial use in the U.S. by the party asserting the defense. In addition, the prior use must have occurred at least one year before the earlier of either: (1) the effective filing date, or (2) the date of the first public disclosure of the claimed invention. The prior-use defense must be established by clear and convincing evidence. In certain cases, this defense does not apply to patents held by universities.

14.4.2.2.4 Bar Against Remedies for Infringement of Medical Procedure Patents by Doctors and Hospitals

Following a lawsuit against a doctor to enforce a patent on a cataract surgery procedure in 1993, the American Medical Association lobbied Congress to exclude medical procedure patents from the scope of patentable subject matter. While declining to curtail the scope of § 101, Congress enacted § 287(c) which bars the enforcement of medical procedure patents against medical practitioners or related health-care entities. This provision does not, however, insulate sellers of medical devices from indirect (inducement or contributory) infringement of medical procedure patents.

14.4.2.2.5 Sovereign Immunity

During the 1980s, intellectual property owners became concerned that states and state agencies, including public universities, might escape or at least frustrate enforcement of federal intellectual property rights by invoking state sovereign immunity under the Eleventh Amendment of the U.S. Constitution. In the early 1990s, Congress enacted a series of laws expressly abrogating state sovereign immunity for intellectual property infringement, including patent violations. The Supreme Court struck down one such act, the Patent and Plant Variety Remedy Clarification Act, on the grounds that Congress cannot abrogate state sovereign immunity on the basis of its Article I powers under the Constitution and that Congress had not established an adequate basis for abrogation of state sovereign immunity pursuant to the Fourteenth Amendment. *Fla. Prepaid Postsecondary Educ. Expense Bd. v. Coll. Sav. Bank*, 527 U.S. 627 (1999). As a result, states and state instrumentalities cannot be sued in federal court for patent infringement without their consent.

14.4.2.3 Unenforceability

A finding that a patent is unenforceable renders each and every claim of that patent unenforceable. By contrast, a finding of invalidity is assessed on a claim-by-claim basis, the result of which may be that some claims are held invalid whereas others are sustained and may continue to be enforceable.

14.4.2.3.1 Inequitable Conduct

Where a patent applicant breaches the duty to prosecute a patent application in good faith and candor, it may result in a finding of inequitable conduct. *See* 37 C.F.R. § 1.56 (2013); *Purdue Pharma L.P. v. Endo Pharm. Inc.*, 410 F.3d 690, 695 (Fed. Cir. 2005). Inequitable conduct may “arise from an affirmative misrepresentation of a material fact, failure to disclose material information, or submission of false material information, coupled with an intent to deceive or mislead the USPTO.” *Id.* A determination that inequitable conduct occurred in relation to one or more claims will render the entire patent unenforceable. *Kingsdown Med. Consultants, Ltd. v. Hollister, Inc.*, 863 F.2d 867, 877 (Fed. Cir. 1988) (en banc in relevant part). Furthermore, inequitable conduct is not limited to the patent-in-suit; it may also render related patents unenforceable where the inequitable conduct had an “immediate and necessary relation” to other patents. *See Consol. Aluminum Corp. v. Foseco Int’l Ltd.*, 910 F.2d 804, 810–12 (Fed. Cir. 1990) (quoting *Keystone Driller Co. v. Gen. Excavator Co.*, 290 U.S. 240, 245 (1933)).

Inequitable conduct claims must be pled with particularity under Federal Rule of Civil Procedure 9(b), and “requires identification of the specific who, what, when, where, and how of the material misrepresentation or omission committed before the USPTO.” *Exergen Corp. v. Wal-Mart Stores, Inc.*, 575 F.3d 1312, 1327 (Fed. Cir. 2009). The accused infringer must prove both materiality and intent by clear and convincing evidence. *See Purdue Pharma*, 410 F.3d at 695. Once these threshold findings are established, the court “must weigh them to determine whether the equities warrant a conclusion that inequitable conduct occurred.” *Id.* at 696. “Intent and

materiality are separate requirements. A district court should not use a ‘sliding scale,’ where a weak showing of intent may be found sufficient based on a strong showing of materiality and vice versa.” *Therasense, Inc. v. Becton, Dickinson & Co.*, 649 F.3d 1276, 1290 (Fed. Cir. 2011) (en banc) (internal citation omitted).

The level of materiality required to establish inequitable conduct is “but-for” materiality. *Id.* at 1291. “[P]rior art is but-for material if the USPTO would not have allowed a claim had it been aware of the undisclosed prior art.” *Id.* at 1291–92. To determine whether the USPTO would have allowed the claim, “the court should apply the preponderance of the evidence standard and give claims their broadest reasonable construction.” *Id.* (citing Manual of Patent Examining Procedure (MPEP) §§ 706, 2111 (8th ed. Rev. 8, July 2010)). Even if the withheld prior art does not invalidate a claim under the clear-and-convincing standard, it may be “but-for” material if it would have blocked patent issuance under the USPTO’s evidentiary standards. *Id.* at 1292 (citing MPEP §§ 706 (preponderance of the evidence), 2111 (broadest reasonable construction)). In addition, “[a]lthough but-for materiality generally must be proved to satisfy the materiality prong of inequitable conduct, [the Federal Circuit] recognizes an exception in cases of affirmative egregious misconduct,” such as the filing of an unmistakably false affidavit. *Id.*

Intent to mislead or deceive the USPTO may be shown by direct evidence or inferred from clear and convincing evidence of the surrounding circumstances. See *Purdue Pharma*, 410 F.3d at 700. A court may not infer intent solely from materiality. *Therasense*, 649 F.3d at 1290. Rather, it must weigh the evidence of intent independent of its analysis of materiality. *Id.* “[T]o meet the clear and convincing evidence standard, the specific intent to deceive must be ‘the single most reasonable inference able to be drawn from the evidence.’” *Id.* (quoting *Star Sci., Inc. v. R.J. Reynolds Tobacco Co.*, 537 F.3d 1357, 1366 (Fed. Cir. 2008)). Otherwise, if multiple reasonable inferences may be drawn, intent to deceive cannot be found. *Id.* at 1290–91.

14.4.2.3.2 Patent Misuse

The affirmative defense of patent misuse exists to prevent harm to the market caused by a patentee extending a patent’s right to exclude beyond its legal scope. The underlying principle of misuse is that an alleged infringer must prove by clear and convincing evidence that a patentee has both “impermissibly broadened the physical or temporal scope of the patent grant” and caused some “anticompetitive effect.” See *Va. Panel Corp. v. MAC Panel Co.*, 133 F.3d 860 (Fed. Cir. 1997). Where the patentee’s behavior remains within the grant of the patent right to exclude, however, there can never be patent misuse. See *Monsanto Co. v. McFarling*, 363 F.3d 1336, 1341 (Fed. Cir. 2004). In response to concern that this judge-made doctrine was vague, unpredictable, and overbroad, Congress exempted several specific behaviors from the doctrine by adding § 271(d). For example, enforcing a patent or refusing to license cannot constitute patent misuse. See §§ 271(d)(3)–(4). Courts scrutinize other behavior under antitrust’s familiar levels of review: per se and rule of reason.

Many behaviors can theoretically constitute patent misuse. Tying sales of a patented good and an unpatented good, package licenses, extending royalties beyond

the patent term, grantback clauses, field-of-use restrictions, horizontal arrangements like patent pools, price discrimination, and market division can all constitute patent misuse if they improperly expand a patent right to anticompetitive effect. A detailed discussion of this doctrine can be found in 1 Herbert Hovenkamp, Mark D. Janis & Mark A. Lemley, *IP and Antitrust* § 3.3 (2006).

14.4.2.3.2.1 Postexpiration Royalties

The Supreme Court held in *Brulotte v. Thys Co.*, 379 U.S. 29, 32 (1964), that license agreements providing for payment of patent royalties beyond the expiration of a patent are per se patent unlawful. The Supreme Court reaffirmed that decision in *Kimble v. Marvel Entertainment, LLC*, 135 S. Ct. 2401 (2015).

14.4.2.3.3 Equitable Estoppel

Equitable estoppel arises where a patentee misleads an alleged infringer into believing that he or she would not be sued for using the patented technology. The defense may bar all relief on an infringement claim. See *A.C. Aukerman Co. v. R.L. Chaides Constr. Co.*, 960 F.2d 1020, 1041 (Fed. Cir. 1992) (en banc). Three elements must be established to prove equitable estoppel:

- (1) The actor, who usually must have knowledge of the true facts, communicates something in a misleading way, either by words, conduct or silence.
- (2) The other relies upon that communication.
- (3) And the other would be harmed materially if the actor is later permitted to assert any claim inconsistent with his earlier conduct.

Id. (quoting D.B. Dobbs, *Handbook on the Law of Remedies* § 2.3, at 42 (1973)). In the patent infringement context, the “something” communicated is that the plaintiff will not bring an infringement claim against the accused infringer. See *id.* at 1042. Accordingly, the defendant must not only be aware of the patentee and/or his patent but also know or reasonably be able to infer that the patentee has been aware of the accused infringer’s acts for some time. A plaintiff’s inaction may give rise to the inference that he abandoned his infringement claim when combined with other facts regarding the parties’ relationship or contracts with each other. Regarding the third factor, material harm may include a change of economic position or loss of evidence. See *id.* at 1043.

Even where the defendant proves all three elements of the estoppel defense, the court must consider “any other evidence and facts respecting the equities of the parties in exercising its discretion and deciding whether to allow the defense of equitable estoppel to bar the suit.” *Id.* The defense does not require an unreasonable delay in filing suit, as is necessary for laches. See *id.* at 1041–42. However, such a delay may be evidence relevant to determining whether the plaintiff’s conduct was misleading.

14.4.2.3.4 Laches

The equitable defense of laches may be available where the plaintiff unreasonably delayed filing his or her infringement suit. See *A.C. Aukerman Co. v. R.L. Chaides Constr. Co.*, 960 F.2d 1020, 1032 (Fed. Cir. 1992) (holding that Congress codified a laches defense in § 282(b)(1)); see also *SCA Hygiene Products Aktiebolag v. First Quality Baby Products, LLC*, 807 F.3d 1311 (Fed. Cir. 2015) (en banc) (holding that *Petrella v. Metro-Goldwyn-Mayer, Inc.*, 134 S. Ct. 1962 (2014) does not disturb the patent laches doctrine articulated in *A.C. Aukerman Co.*). The defense is applicable where the accused infringer proves two factors:

- (1) the plaintiff delayed filing suit for an unreasonable and inexcusable length of time from the time the plaintiff knew or reasonably should have known of its claim against the defendant, and
- (2) the delay operated to the prejudice or injury of the defendant.

A.C. Aukerman Co., 960 F.2d at 1028. The period of delay is defined as the time from when the plaintiff knew or reasonably should have known of the defendant's alleged infringing acts until the date of suit. *Id.* This period may not begin until after the patent issues. *Id.* Regarding the second factor, prejudice to the defendant may be either economic or evidentiary. See *id.* at 1033. A laches defense may be defeated where the infringer "has engaged in particularly egregious conduct which would change the equities significantly in plaintiff's favor." *Id.* (quoting *TWM Mfg. Co. v. Dura Corp.*, 592 F.2d 346, 349 (6th Cir. 1979)). Laches only bars damages accrued prior to suit. See *id.* at 1041.

A rebuttable presumption of laches exists where the accused infringer proves that the plaintiff delayed filing suit for more than six years after actual or constructive knowledge of the defendant's alleged infringing acts. See *id.* at 1035–36, 1038. The defendant's burden of persuasion does not shift as a result of the plaintiff's six-year delay. See *id.* at 1039.

14.4.2.3.4.1 Prosecution Laches

A special form of laches—prosecution laches—renders a patent unenforceable where the patentee unreasonably delayed in prosecuting the patent, and the accused infringer or others suffered prejudice by the delay. *Cancer Research Tech. Ltd. v. Barr Labs., Inc.*, 625 F.3d 724, 729 (Fed. Cir. 2010). "[T]o establish prejudice[,] an accused infringer must show evidence of intervening rights, *i.e.*, that either the accused infringer or others invested in, worked on, or used the claimed technology during the period of delay." *Id.* The Federal Circuit reviews a determination of prosecution laches for abuse of discretion. *Id.* at 728–29. The Federal Circuit has left the threshold for applying prosecution laches somewhat vague, but stressed that it should only be invoked in "egregious cases of misuse of the statutory patent system." *Symbol Techs., Inc. v. Lemelson Med., Educ. & Research Found., L.P.*, 422 F.3d 1378, 1385 (Fed. Cir. 2005) (affirming judgment of unenforceability due to prosecution laches where patent applications were pending between eighteen to thirty-nine years, the

applicant had engaged in “culpable neglect” in allowing them to linger, and intervening rights had developed).

14.4.2.4 Invalidity

The invalidity defense may be asserted where the patent fails to comply with any of the statutory requirements provided in §§ 101, 102, 103, and 112. Under § 282, a patent is presumed to be valid. “The presumption of validity is based on the presumption of administrative correctness of actions of the agency charged with examination of patentability.” *Applied Materials, Inc. v. Advanced Semiconductor Materials Am., Inc.*, 98 F.3d 1563, 1569 (Fed. Cir. 1996). Accordingly, the burden of proving invalidity of a claim rests on the accused infringer, who must prove invalidity by clear and convincing evidence. *Microsoft Corp. v. i4i Ltd. P’ship*, 131 S. Ct. 2238 (2011).

Once a claim is declared invalid, patentees are collaterally estopped from asserting the claim unless they can show that they did not have “a fair opportunity procedurally, substantively and evidentially to pursue [their] claim the first time.” *Blonder-Tongue Labs., Inc. v. Univ. of Ill. Found.*, 402 U.S. 313, 332–33, 350 (1971).

14.4.2.4.1 Double Patenting

Courts have interpreted patent law to forbid a second patent from covering the same invention or an obvious variation of it so as to prevent patentees from extending the duration of their patents by patenting the same subject matter more than once. The cases distinguish between two forms of double patenting: (1) so-called statutory or same-invention double patenting; and (2) obviousness-type or non-statutory double patenting. The former draws upon the language of § 101 stating that “[w]hoever invents or discovers any new and useful [invention] may obtain a patent therefore” Use of the singular implies that inventors are entitled to only one patent per invention. The latter is a judicial doctrine intended to prevent prolongation of the patent term through the assertion of claims that were made obvious by a prior patent of the same inventor. A patent which merely discloses a prior invention does not double patent—only the claims matter.

14.4.2.4.1.1 Statutory, or Same-Invention

Statutory double patenting occurs when the claims of a later patent would infringe an earlier-issued patent by the same inventor. This can happen where multiple patents derive from a common application. The courts have interpreted § 121 (relating to divisional applications, *see* § 14.2.2.3) as shielding applicants subject to a restriction requirement from the double-patenting doctrine. *See Eli Lilly & Co. v. Barr Labs., Inc.*, 251 F.3d 955 (Fed. Cir. 2001) (holding that a species patent that issues before an earlier-filed genus patent is not a double patent if the order of issue was due solely to USPTO delay); *Gerber Garment Tech., Inc. v. Letra Sys.*, 916 F.2d 683 (Fed. Cir. 1990) (holding that divisional application from a USPTO restriction requirement is not a double patent as long as divisional claims have not materially changed).

14.4.2.4.1.2 Nonstatutory or Obviousness-Type

Obviousness-type double patenting occurs when a later patent is made obvious by an earlier patent of the same inventor. Thus, where a prior patent for “pork” packing exists, a later patent which claims technology for “meat” packing is an obviousness-type double patent, but not a same-invention double patent. *See Eli Lilly & Co. v. Barr Labs., Inc.*, 251 F.3d 955, 967–72 (Fed. Cir. 2001); *In re Vogel*, 422 F.2d 438 (C.C.P.A. 1970). Where double patenting allegations arise, patentees often elect to shorten the term of their second patent so that it expires with the first, precluding concern over double patenting as long as each subsequent patent remains commonly owned. *See* § 253; 37 C.F.R. § 1.321(c)(3); § 14.2.5.1 (terminal disclaimer).

In addition, “a later-issued, but earlier-expiring patent could qualify as a double patenting reference, and thus invalidate an earlier-issued but later-expiring patent.” *AbbVie Inc. v. Kennedy Inst. of Rheumatology*, 764 F.3d 1366, 1374 (Fed. Cir. 2014) (citing *Gilead Scis., Inc. v. Natco Pharma Ltd.*, 753 F.3d 1208, 1217 (Fed. Cir. 2014)).

14.4.2.4.2 Estoppel by Transfer of Ownership

Although patent validity may generally be challenged by third parties, courts have developed doctrines affecting whether patent invalidity may be asserted by those in privity with the patent owner. These doctrines derived from principles holding that parties to contracts relating to property ought not to be permitted to question the consideration on which the deeds or other property conveyances were based. These doctrines have been reassessed in light of patent-law policies.

14.4.2.4.2.1 Assignor Estoppel

Under the doctrine of assignor estoppel, a seller of a patent or patent application may not, absent exceptional circumstances, attack the validity of that patent in a subsequent patent-infringement litigation. *See Mentor Graphics Corp. v. Quickturn Design Systems, Inc.*, 150 F.3d 1374, 1378 (Fed. Cir. 1998); *Diamond Scientific Co. v. Ambico, Inc.*, 848 F.2d 1220, 1223 (Fed. Cir. 1988). The doctrine derives from legal estoppel (or estoppel by deed), which prohibits a grantor of property from challenging the validity of the grant. *See Westinghouse Elec. & Mfg. Co. v. Formica Insulation Co.*, 266 U.S. 342, 348–49 (1924). Notwithstanding dicta in *Lear, Inc. v. Adkins*, 395 U.S. 653, 670–71 (1969) (“Surely the equities of the licensor do not weigh very heavily when they are balanced against the important public interest in permitting full and free competition in the use of ideas which are in reality a part of the public domain.”), *see* § 14.4.2.4.2.2 (discussing rejection of licensee estoppel); *see e.g., Coastal Dynamics Corp. v. Symbolic Displays, Inc.*, 469 F.2d 79 (9th Cir. 1972) (per curiam) (holding that dicta in *Lear* indicates that the assignor estoppel doctrine is no longer valid), the Federal Circuit continues to uphold the assignor estoppel doctrine. *See Diamond Scientific*, 848 F.2d at 1223 (Fed. Cir. 1988) (“Beyond the questioning dicta in *Lear*, the Court has left assignment estoppel untouched . . .”). The considerations supporting the assignor estoppel doctrine (encouraging fair dealing) differ from those motivating the licensee estoppel doctrine (fostering free competition). *Cf. id.* at 1224 (“Unlike the licensee, who, without *Lear* might be forced to continue to pay for

a potentially invalid patent, the assignor who would challenge the patent has already been fully paid for the patent rights.”).

The doctrine of assignor estoppel is not absolute and courts have allowed assignors to challenge patent validity in exceptional circumstances. “A determination whether assignor estoppel applies in a particular case requires a balancing of the equities between the parties.” See *Carroll Touch, Inc. v. Electro Mechanical Systems, Inc.*, 15 F.3d 1573, 1579 (Fed. Cir. 1993). Such balancing is a matter committed to the discretion of the trial court. See *id.* (analogizing to laches defense; nonetheless overturning the determination that assignor estoppel did not apply where the trial court’s findings—that the controlling owner of defendant, a named inventor and former employee of the firm that assigned the patent, played only a minimal role in the invention and was misled as to the scope of the patent at issue—were not adequately supported by the entire record).

Exceptional circumstances disfavoring application of the assignor estoppel doctrine include: an express reservation by the assignor of the right to challenge the validity of the patent or an express waiver by the assignee of the right to assert assignor estoppel, *cf. Mentor Graphics Corp. v. Quickturn Design Systems, Inc.*, 150 F.3d 1374, 1378 (Fed. Cir. 1998); where the assignor’s participation was under duress, *cf. Shamrock Technologies, Inc. v. Medical Sterilization, Inc.*, 903 F.2d 789, 793 (Fed. Cir. 1990); or where the rights were assigned prior to the invention being completed (and hence it might not be reasonable to presume the assignor’s representation that the patent was valid).

14.4.2.4.2.2 No Licensee Estoppel

Under traditional contract and property principles, “one receiving bargained-for benefits under a contract may not question the consideration he has received.” See Robert B. Orr, Note, *The Doctrine of Licensee Repudiation in Patent Law*, 63 Yale L.J. 125 (1953). Courts applied this doctrine to bar patent licensees from challenging the validity of the patents supporting their bargain since the mid-nineteenth century. See *Automatic Radio Manufacturing Co. v. Hazeltine Research, Inc.*, 339 U.S. 827, 836 (1950); *United States v. Harvey Steel Co.*, 196 U.S. 310, 317 (1905); 3 William C. Robinson, *A Treatise on the Law of Patents for Useful Inventions* § 1252 (1890) (“The licensee, in his defense, cannot attack the patent or the title of his licensor.”); *but cf. Lear, Inc. v. Adkins*, 395 U.S. 653, 663–64 (1969) (observing that “[l]ong before *Hazeltine* was decided, the estoppel doctrine had been so eroded that it could no longer be considered the ‘general rule,’ but was only to be invoked in an ever narrowing set of circumstances”). The applicability of this doctrine to patents came under scrutiny for failing to account for the larger public-policy considerations surrounding patents. See James M. Treece, *Licensee Estoppel in Patent and Trademark Cases*, 53 Iowa L. Rev. 525, 542 (1967); *cf. Sears, Roebuck & Company v. Stiffel Company*, 376 U.S. 225, 229–31 (1964) (emphasizing the public interest in a robust public domain); *Compco Corporation v. Day-Brite Lighting, Inc.*, 376 U.S. 234 (1964) (same); *cf. Brulotte v. Thys Company*, 379 U.S. 29 (1964) (declaring as per se unlawful a patentee’s agreement projecting royalty payments beyond the patent’s expiration); *Kimble v. Marvel Entertainment, LLC*, 135 S. Ct. 2401 (2015) (reaffirming *Brulotte*).

The Supreme Court looked to “the strong federal policy favoring free competition in ideas which do not merit patent protection” reflected in these cases in overturning more than a century of jurisprudence and rejecting the doctrine of licensee estoppel. *See Lear, Inc. v. Adkins*, 395 U.S. 653, 670–71 (1969). The Court emphasized:

Licensees may often be the only individuals with enough economic incentive to challenge the patentability of an inventor’s discovery. If they are muzzled, the public may continually be required to pay tribute to would-be monopolists without need or justification. We think it plain that the technical requirements of contract doctrine must give way before the demands of the public interest in the typical situation involving the negotiation of a license after a patent has issued.

Id.

14.4.2.4.2.3 Assignee Estoppel

Although the basic rationale of *Lear v. Adkins* (*see* § 14.4.2.4.2.2) would appear to apply to assignees (*see* 6 Moy’s *Walker on Patents* § 17:42 (4th ed.)), a few courts have declined to extend the doctrine. *See, e.g., Coast Metals, Inc. v. Cape*, 205 U.S.P.Q. 154 (D.N.J. 1979); *Baladevon, Inc. v. Abbott Laboratories, Inc.*, 871 F. Supp. 89, 95 (D. Mass. 1994) (“Outside of licensee estoppel, which is commonly understood to have been abolished by *Lear*, the status of estoppel doctrines in patent law has not been definitively settled. The weight of authority holds that the doctrine of assignee estoppel survived *Lear*.”); *see also Diamond Scientific Co. v. Ambico, Inc.*, 848 F.2d 1220, 1224–25 (Fed. Cir. 1988) (citing two decisions holding that an assignee may be estopped from challenging the validity of the assigned patent: *Roberts v. Sears, Roebuck & Co.*, 573 F.2d 976 (7th Cir. 1978), and *Coast Metals, Inc. v. Cape*, 205 U.S.P.Q. 154 (D.N.J. 1979)).

14.4.2.5 Antitrust Counterclaims

While not technically a defense, antitrust counterclaims frequently arise in patent cases. *See* 1 Herbert Hovenkamp, Mark D. Janis & Mark A. Lemley, *IP and Antitrust* § 13.1, 11–12 (2006) (observing that between 1993 and 2000, there were more than 100 reported decisions regarding counterclaims alleging the original suit was anticompetitive behavior in violation of the antitrust laws). Patent litigation can constitute an attempt to monopolize in violation of § 2 of the Sherman Act in two contexts: (1) where the counterclaimant can show that the patentee obtained the patent through fraud on the Patent Office, *see, e.g., Walker Process Equip., Inc. v. Food Mach. & Chem. Corp.*, 382 U.S. 172 (1965); and (2) where the counterclaimant can establish that the litigation is a “mere sham,” which requires proving that the initial suit is objectively baseless and motivated by a desire to impose harm. *See In re Indep. Serv. Orgs. Antitrust Litig.*, 203 F.3d 1322, 1326 (Fed. Cir. 2000); *Nobelpharma AB v. Implant Innovations, Inc.*, 141 F.3d 1059 (Fed. Cir. 1998); *Handgards, Inc. v. Ethicon, Inc.*, 601 F.2d 986 (9th Cir. 1979).

Most antitrust counterclaims ultimately fail. *See* David R. Steinman & Danielle S. Fitzpatrick, *Antitrust Counterclaims in Patent Infringement Cases: A Guide to Walker*

Process and Sham-Litigation Claims, 10 Tex. Intell. Prop. L.J. 95, 99 & n.22 (2001). Because of the Federal Circuit's strict requirements for stating a Sherman Act § 2 claim, and the Supreme Court's concern about the scope of discovery in antitrust cases, these counterclaims can potentially be dismissed on the pleadings or on summary judgment. See *Bell Atlantic Corp. v. Twombly*, 550 U.S. 544 (2007).

14.4.3 Remedies

Patent law provides a potent arsenal of remedies, including injunctive relief, damages (which can be enhanced based on an infringer's conduct), costs, prejudgment interest, and attorneys' fees.

14.4.3.1 Injunctive Relief

Section 283 of the Patent Act provides that courts "may grant injunctions in accordance with the principles of equity to prevent the violation of any right secured by patent, on such terms as the court deems reasonable." Injunctive relief serves to protect and uphold the right to exclude granted by a patent. *Smith Int'l v. Hughes Tool Co.*, 718 F.2d 1573, 1577-78 (Fed. Cir. 1983). The law permits both preliminary and permanent injunctions.

14.4.3.1.1 Preliminary Injunction

In assessing whether to grant a preliminary injunction, the court must consider four factors, with the burden of proof on the moving party:

- (1) the likelihood of the movant's success on the merits (validity, enforceability, and infringement),
- (2) the irreparability of harm to the movant without an injunction,
- (3) the balance of hardships between the parties, and
- (4) the demands of the public interest.

AstraZeneca LP v. Apotex, Inc., 633 F.3d 1042 (Fed. Cir. 2010); see generally Chapter 3. The court must balance these factors in the interests of equity. No one factor is dispositive. *FMC Corp. v. United States*, 3 F.3d 424, 427 (Fed. Cir. 1993). Prior to the establishment of the Federal Circuit in 1982, courts rarely granted preliminary injunctive relief in patent cases on the grounds that likelihood of success on the merits typically required prior judicial determination of validity and the difficulty of establishing irreparable harm due to the availability of compensatory damages after trial. The Federal Circuit substantially eased these requirements soon after its creation by emphasizing the role of equity to protect the right to exclude and erecting a rebuttable presumption of irreparable harm once validity and continuing infringement were established. See *Smith Int'l v. Hughes Tool Co.*, 718 F.2d 1573 (Fed. Cir. 1983). A decade later, the Federal Circuit shifted toward a higher burden on movants, noting that a preliminary injunction "is a drastic and extraordinary remedy . . . not to be routinely granted." See *Intel v. ULSI*, 995 F.2d 1566, 1568 (Fed. Cir. 1993). The Supreme Court's decision in *eBay Inc. v. MercExchange, L.L.C.*, 547 U.S. 388 (2006), discussed

in § 14.4.3.1.2, provides the most authoritative word on the exercise of discretion in assessing injunctive relief in patent cases. Although the case involved the granting of permanent injunctive relief, its analysis applies with extra force in the context of preliminary injunctions—where caution in granting relief is especially important.

The Federal Circuit has since further restricted the grant of preliminary and permanent injunctions on multifeatured products by introducing a “causal nexus” requirement to inform the irreparable harm inquiry. A patentee must show a “casual nexus” between its alleged harm and the defendant’s infringement before a court can issue an injunction on a multifeature product. See *Apple Inc. v. Samsung Elecs. Co.*, 678 F.3d 1314, 1324 (Fed. Cir. 2012); *Apple Inc. v. Samsung Elecs. Co. (Apple III)*, 735 F.3d 1352 (Fed. Cir. 2013) (extending the “causal nexus” requirement to permanent injunctions). To satisfy the “causal nexus” inquiry, the patentee must prove that the infringing feature drove demand for the entire product. See *Apple, Inc. v. Samsung Elecs. Co.*, 695 F.3d 1370, 1374–75 (Fed. Cir. 2012); see also § 3.2.2.2.4.

The patent holder has the burden of proof to demonstrate the predicates for a preliminary injunction. See *Abbott Labs. v. Andrx Pharm., Inc.*, 452 F.3d 1331, 1334 (Fed. Cir. 2006). This includes the burden of showing that the asserted patents likely are infringed and the absence of any substantial question that the asserted patent claims are valid (*Trebro Mfg., Inc. v. Firefly Equip., LLC*, 748 F.3d 1159, 1166–67 (Fed. Cir. 2014)) or that the patent is enforceable (*Purdue Pharma L.P. v. Boehringer Ingelheim GmbH*, 237 F.3d 1359, 1366 (Fed. Cir. 2001)). On the other hand, an accused infringer challenging a preliminary injunction can be successful on evidence that would not suffice to support an invalidity judgment at trial, but merely raises a substantial question concerning either infringement or validity. *Id.* The showing of a substantial question as to invalidity requires less proof than a clear and convincing showing necessary to establish invalidity itself. *Id.* “Vulnerability is the issue at the preliminary injunction stage, while validity is the issue at trial.” *Id.*

14.4.3.1.2 Permanent Injunction

A court may enter a permanent injunction after a final judgment of infringement in accord with principles of equity. § 283. To obtain a permanent injunction, the plaintiff must satisfy a four-factor test, similar to the test used for preliminary injunctions. See *eBay Inc. v. MercExchange, L.L.C.*, 547 U.S. 388, 391 (2006). The plaintiff must show:

- (1) That it has suffered an irreparable injury;
- (2) That remedies available at law, such as monetary damages, are inadequate to compensate for that injury;
- (3) That, considering the balance of hardships between the plaintiff and defendant, a remedy in equity is warranted; and
- (4) That the public interest would not be disserved by a permanent injunction.

In the past, courts routinely issued permanent injunctions once infringement had been found. See *id.* at 393–94 (“The [Federal Circuit] articulated a ‘general rule,’ unique to patent disputes, ‘that a permanent injunction will issue once infringement

and validity have been adjudged.”). However, in *eBay*, the Supreme Court explicitly overruled such categorical granting of injunctive relief. *See id.* at 394. Accordingly, courts must carefully apply the four-factor test in determining whether to grant a permanent injunction. As with all injunctions, the district court’s order is reviewed for abuse of discretion.

eBay eliminates any presumption of irreparable injury to a patent holder after a judgment of infringement and no invalidity. *Robert Bosch LLC v. Pylon Mfg. Corp.*, 659 F.3d 1142, 1149 (2011). The Federal Circuit also has also held that there must be a “causal nexus” between any such irreparable injury and patent infringement. *Apple III*, 735 F.3d at 1360. In a case in which the harm stems from lost sales owing to a competitor’s infringement, this requires proof that “the patented features impact consumers’ decisions to purchase the accused devices” even if they are not “the exclusive or predominant reason why consumers bought ... [the infringing] products.” *Apple Inc. v. Samsung Elecs. Co.*, 801 F.3d 1352, 1360 (Fed. Cir. 2015).

14.4.3.2 Damages

Section 284 of the Patent Act provides:

Upon finding for the claimant the court shall award the claimant damages adequate to compensate for the infringement but in no event less than a reasonable royalty for the use made of the invention by the infringer, together with interest and costs as fixed by the court.

When the damages are not found by a jury, the court shall assess them. In either event the court may increase the damages up to three times the amount found or assessed. Increased damages under this paragraph shall not apply to provisional rights under section 154(d) of this title.

The court may receive expert testimony as an aid to the determination of damages or of what royalty would be reasonable under the circumstances.

Section 286 establishes a six-year statute of limitations, barring patentees from recovering damages for any infringing acts committed more than six years prior to the filing of the complaint or counterclaim for infringement.

14.4.3.2.1 Compensatory Damages

Courts apply several approaches for measuring damages “adequate to compensate” for a defendant’s infringement.

14.4.3.2.1.1 Lost Profits

To recover lost-profits damages, the patentee must prove a causal relation between the infringement and its lost profits. *See Crystal Semiconductor Corp. v. Tritech Microelectronics Int’l, Inc.*, 246 F.3d 1336, 1354 (Fed. Cir. 2001). Accordingly, the patentee must show “a reasonable probability that ‘but for’ the infringing activity, the patentee would have made the infringer’s sales.” *Id.* An accepted, “but non-exclusive” method for establishing “but-for” causation is the four-factor “DAMP” test, under which the patentee must prove:

- (1) Demand for the patented product;
- (2) Absence of acceptable noninfringing substitutes;
- (3) Manufacturing and marketing capability to exploit the demand; and
- (4) Profit he would have made.

Rite-Hite Corp. v. Kelley Co., 56 F.3d 1538, 1545 (Fed. Cir. 1995) (en banc) (citing *Panduit Corp. v. Stahl Bros. Fibre Works, Inc.*, 575 F.2d 1152, 1156 (6th Cir. 1978)). Additionally, the patentee is required to show that the damages were or should have been reasonably foreseeable by an infringing competitor in the relevant market. *See id.* at 1546.

14.4.3.2.1.2 Convoyed Sales

“A ‘convoyed sale’ refers to the relationship between the sale of a patented product and a functionally associated nonpatented product. A patentee may recover lost profits on unpatented components sold with a patented item, a convoyed sale, if both the patented and unpatented products ‘together were considered to be components of a single assembly or parts of a complete machine, or they together constituted a functional unit.’” *Am. Seating Co. v. USSC Grp., Inc.*, 514 F.3d 1262, 1268 (Fed. Cir. 2008) (citing *Rite-Hite*, 56 F.3d at 1550). “A functional relationship does not exist when independently operating patented and unpatented products are purchased as a package solely because of customer demand.” *Id.*

14.4.3.2.1.3 Price Erosion

The patentee may also recover additional lost profits damages under a price-erosion theory. *See Crystal Semiconductor Corp. v. TriTech Microelectronics Int’l, Inc.*, 246 F.3d 1336, 1357 (Fed. Cir. 2001). To recover for price-erosion damages, patentees are required to prove that “but for” the infringement, they would have sold their patented invention at a higher price. *Id.* Furthermore, patentees must prove the number of products they would have sold at this price. *Id.* Accordingly, “the patentee’s price erosion theory must account for the nature, or definition, of the market, similarities between any benchmark market and the market in which price erosion is alleged, and the effect of the hypothetically increased price on the likely number of sales at that price in that market.” *Id.*

Because lost sales and price erosion are “inextricably linked,” patentees must show how a price increase would have affected their profits due to lost sales. *See id.* at 1360. Consequently, the court should not independently analyze lost profits and price-erosion damages. *See id.*

14.4.3.2.1.4 Reasonable Royalty

Under § 284, the patentee may recover no less than a reasonable royalty on the infringer’s sales for which the patentee has not shown entitlement to lost profits. *See Rite-Hite Corp. v. Kelley Co.*, 56 F.3d 1538, 1554 (Fed. Cir. 1995) (en banc). A reasonable royalty may be derived from an established royalty (if one exists) or, more

commonly, from a hypothetical negotiation between the patentee and the infringer when the infringement began. *Id.*

The hypothetical negotiation (during which the asserted patent claims are assumed to be valid and infringed) tries “to recreate the *ex ante* licensing negotiation scenario and to describe the resulting agreement.” *Lucent Techs., Inc. v. Gateway, Inc.*, 580 F.3d 1301, 1325 (Fed. Cir. 2009). Evidence relevant to calculating the reasonable royalty may include not only factual developments before the date of the hypothetical negotiation, but also events occurring after that date. *Id.* at 1333–34.

Determining the reasonable royalty based on the hypothetical negotiation commonly involves an analysis of the factors set forth in *Georgia-Pacific Corp. v. U.S. Plywood Corp.*, 318 F. Supp. 1116 (S.D.N.Y. 1970):

- (1) The royalties received by the patentee for the licensing of the patent in suit, proving or tending to prove an established royalty.
- (2) The rates paid by the licensee for the use of other patents comparable to the patent in suit.
- (3) The nature and scope of the license, as exclusive or non-exclusive; or as restricted or non-restricted in terms of territory or with respect to whom the manufactured product may be sold.
- (4) The licensor’s established policy and marketing program to maintain his patent monopoly by not licensing others to use the invention or by granting licenses under special conditions designed to preserve that monopoly.
- (5) The commercial relationship between the licensor and licensee, such as, whether they are competitors in the same territory in the same line of business; or whether they are inventor and promoter.
- (6) The effect of selling the patented specialty in promoting sales of other products of the licensee; the existing value of the invention to the licensor as a generator of sales of his non-patented items; and the extent of such derivative or convoyed sales.
- (7) The duration of the patent and the term of the license.
- (8) The established profitability of the product made under the patent; its commercial success; and its current popularity.
- (9) The utility and advantages of the patent property over the old modes or devices, if any, that had been used for working out similar results.
- (10) The nature of the patented invention; the character of the commercial embodiment of it as owned and produced by the

licensor; and the benefits to those who have used the invention.

- (11) The extent to which the infringer has made use of the invention; and any evidence probative of the value of that use.
- (12) The portion of the profit or of the selling price that may be customary in the particular business or in comparable businesses to allow for the use of the invention or analogous inventions.
- (13) The portion of the realizable profit that should be credited to the invention as distinguished from non-patented elements, the manufacturing process, business risks, or significant features or improvements added by the infringer.
- (14) The opinion testimony of qualified experts.
- (15) The amount that a licensor (such as the patentee) and a licensee (such as the infringer) would have agreed upon (at the time the infringement began) if both had been reasonably and voluntarily trying to reach an agreement; that is, the amount which a prudent licensee—who desired, as a business proposition, to obtain a license to manufacture and sell a particular article embodying the patented invention—would have been willing to pay as a royalty and yet be able to make a reasonable profit and which amount would have been acceptable by a prudent patentee who was willing to grant a license.

Id. at 1120. The *Georgia-Pacific* factors are unprioritized, and some factors may overlap. See *ResQNet.com, Inc. v. Lansa, Inc.*, 594 F.3d 860, 869 (Fed. Cir. 2010).

14.4.3.2.1.4.1 Damages Theories

A reasonable royalty calculation will typically require determining the royalty base and the royalty rate. The determination is relatively straightforward where the demand for a final product comprises a single patented technology, such as a drug with a patented active ingredient. The most sensible royalty base would typically be total sales revenue for the final product, what is often referred to as the entire market value. See *Fonar Corp. v. Gen. Elec. Co.*, 107 F.3d 1543, 1552 (Fed. Cir. 1997) (citing *Rite-Hite Corp. v. Kelley Co.*, 56 F.3d 1538, 1549 (Fed. Cir. 1995) (en banc)). The royalty rate would account for alternative treatments (of which there may be few), marketing costs, and manufacturing costs.

Patent law has long struggled to deal with apportioning patent value where a patent covers only one component of a larger product. See *Cincinnati Car Co. v. New York Rapid Transit Corp.*, 66 F.2d 592, 593 (2d Cir. 1933) (Learned Hand, J.) (observing that the allocation of profits among multiple components “is in its nature unanswerable”). The problem has become particularly acute in modern patent litigation as a result of the growing use of juries called upon to apportion value based on complex and often widely divergent economic expert analyses.

In theory, a wide range of royalty bases can be appropriate with an appropriately calibrated royalty rate to account for the myriad factors affecting consumer demand. In practice, however, the open-ended nature of the *Georgia-Pacific* framework can lead to wildly divergent royalty calculations by expert economists. Especially in a jury trial, such testimony can produce outsize damage awards. As the Supreme Court recognized long ago, it would be “very grave error to instruct a jury ‘that as to the measure of damages the same rule is to govern, whether the patent covers an entire machine or an improvement on a machine.’” *Seymore v. McCormick*, 57 U.S. 480, 491 (1853); see also *Westinghouse Elec. & Mfg. Co. v. Wagner Co.*, 225 U.S. 604, 614–15 (1912) (“[The] invention may have been used in combination with valuable improvements made, or other patents appropriated by the infringer, and each may have jointly, but unequally contributed to the profits. In such case, if plaintiff’s patent only created a part of the profits, he is only entitled to recover that part of the net gains.”); *Garretson v. Clark*, 111 U.S. 120, 121 (1884) (“When a patent is for an improvement, and not for an entirely new machine or contrivance, the patentee must show in what particulars his improvement has added to the usefulness of the machine or contrivance.”)

While estimating a reasonable royalty is not an “exact science” in that there may be more than one reliable method, *Apple Inc. v. Motorola, Inc.*, 757 F.3d 1286, 1315 (Fed. Cir. 2014), the Federal Circuit has enhanced the judge’s gatekeeping role in order to prevent excessive awards. Recent decisions have sought to align the royalty base to the patented component of a product, exclude unreliable damages theories, scrutinize the admissibility of various forms of evidence, and provide limiting jury instructions.

In general, a patent holder seeking a reasonable royalty must provide substantial evidence supporting both its choice of royalty base and royalty rate. “[W]here multi-component products are involved, the governing rule is that the ultimate combination of royalty base and royalty rate must reflect the value attributable to the infringing features of the product, and no more.” *Ericsson, Inc. v. D-Link Sys., Inc.*, 773 F.3d 1201, 1226 (Fed. Cir. 2014) (citing *VirnetX, Inc. v. Cisco Sys., Inc.*, 767 F.3d 1308 (Fed. Cir. 2014)).

As the Federal Circuit has warned, “reliance on the entire market value might mislead the jury, who may be less equipped to understand the extent to which the royalty rate would need to do the work in such instances.” *Ericsson*, 773 F.3d at 1227 (citing *LaserDynamics, Inc. v. Quanta Computer, Inc.*, 694 F.3d 51, 67, 68 (Fed. Cir. 2012) (barring the use of too high a royalty base—even if mathematically offset by a “low enough royalty rate”—because such a base “carries a considerable risk” of misleading a jury into overcompensating, stating that such a base “cannot help but skew the damages horizon for the jury” and “make a patentee’s proffered damages amount appear modest by comparison” (quoting *Uniloc USA, Inc. v. Microsoft Corp.*, 632 F.3d 1292, 1320 (Fed. Cir. 2011)))).

To cabin the risk of outsize awards in multicomponent cases, the Federal Circuit has pushed the royalty base toward the smallest salable patent-practicing unit or “SSPPU.” See *Cornell Univ. v. Hewlett-Packard Co.*, 609 F. Supp. 2d 279 (N.D.N.Y. 2009) (Rader, J., sitting by designation). The Federal Circuit embraced the SSPPU

framework in *LaserDynamics Inc. v. Quanta Computer, Inc.*, 694 F.3d 51 (Fed. Cir. 2012), holding that “it is generally required that royalties be based not on the entire product, but instead on the ‘smallest salable patent-practicing unit.’ . . . The entire market value rule is a narrow exception to this general rule.” *Id.* at 67; *see also VirnetX, Inc. v. Cisco Sys., Inc.*, 767 F.3d 1308, 1328–29 (Fed. Cir. 2014); *LaserDynamics, Inc. v. Quanta Comput., Inc.*, 694 F.3d 51, 66–70 (Fed. Cir. 2012); *Uniloc USA, Inc. v. Microsoft Corp.*, 632 F.3d 1292, 1320 (Fed. Cir. 2011); *Lucent Techs., Inc. v. Gateway, Inc.*, 580 F.3d 1301, 1336 (Fed. Cir. 2009).

Beyond calibrating the royalty base to the scale of the patent-practicing unit, courts seek to ensure that the royalty rate is based on sound economic methodology and grounded in reliable and pertinent evidence. Using the construct of the hypothetical negotiation between a willing licensor and licensee, experts use the *Georgia-Pacific* factors to determine a license rate that would have been agreed upon just before the infringement began (and based on the assumption that the patent was valid, infringed, and enforceable). The proof of an appropriate royalty rate using this method allows for necessary “approximation and uncertainty.” *Aqua Shield v. Inter Pool Cover Team*, 774 F.3d 766, 771 (Fed. Cir. 2014). Nevertheless, it must be supported by substantial evidence, which usually will be based on the application of the relevant, but not necessarily the complete list of fifteen, *Georgia-Pacific* factors. *See WhitServe, LLC v. Computer Packages, Inc.*, 694 F.3d 10, 31–32 (Fed. Cir. 2012).

The open-ended *Georgia-Pacific* framework affords economic experts substantial leeway in determining a royalty rate. The most pertinent evidence usually comprises past licenses to the infringing or comparable technology, the value of comparable features in the marketplace, an estimate of the value of the benefit provided by the infringed features by comparison to noninfringing alternatives, or an estimate of the cost to design around the patent. *See, e.g., Ericsson*, 773 F.3d at 1227 (citing *Monsanto Co. v. McFarling*, 488 F.3d 973, 978 (Fed. Cir. 2007) (“An established royalty is usually the best measure of a ‘reasonable’ royalty for a given use of an invention . . .”). However, license agreements that are unrelated to the claimed invention cannot form the basis of a reasonable royalty calculation. *See, e.g., Lucent*, 580 F.3d at 1327; *see also ResQNet*, 594 F.3d at 869 (“Any evidence unrelated to the claimed invention does not support compensation for infringement but punishes beyond the reach of the statute.”). The Federal Circuit has observed that licenses arising out of litigation might be reliable in certain circumstances, but has cautioned that “litigation itself can skew the results of the hypothetical negotiation.” *ResQNet*, 594 F.3d at 872.

In many cases, the technology either has not been previously licensed or the licenses cover a broader range of technologies than the patented invention and/or multiple product or product components. As an alternative or shortcut to considering the *Georgia-Pacific* factors, some patentees have put forward general royalty theories such as the 25% rule and the Nash Bargaining Solution (50% split of net product value). The Federal Circuit has rejected the application of these generalized “rules of thumb.” *See Apple*, 757 F.3d at 1324–25; *VirnetX*, 767 F.3d at 1331–34 (rejecting the Nash Bargaining Solution); *Uniloc*, 632 F.3d at 1312 (rejecting the “25% Rule”); *but cf. Summit 6, LLC v. Samsung Electronics Co., Ltd.*, 802 F.3d 1283 (Fed.

Cir. 2015) (allowing limited use of the Nash Bargaining Solution as part of a multifaceted expert analysis).

Damages experts have begun to deploy consumer surveys to allocate value within multicomponent patented products. See Zelin Yang, Note, *Damaging Royalties: An Overview of Reasonable Royalty Damages*, 29 Berkeley Tech. L.J. 647, 664 (2014); S. Christian Platt & Bob Chen, *Recent Trends and Approaches in Calculating Patent Damages: Nash Bargaining Solution and Conjoint Surveys*, 86 Patent, Trademark & Copyright J. (BNA) 909 (Aug. 30, 2013). Marketing researchers have long used “conjoint analysis” to differentiate value within product configurations. See Paul E. Green, Abba M. Krieger & Yoram Wind, *Thirty Years of Conjoint Analysis: Reflections and Prospects*, 31 Interfaces 56 (2001); Paul E. Green and V. Srinivasan, *Conjoint Analysis in Marketing: New Developments with Implications for Research and Practice*, 54(4) J. of Marketing 3 (1990).

Conjoint analysis draws upon consumer ranking of products with different features. Researchers use statistical methods to estimate consumers’ willingness to pay for particular attributes. While these methods provide a logical framework for differentiating value, the technique can be limited in practice. See Patricia Dyck, *Beyond Confusion—Survey Evidence of Consumer Demand and the Entire Market Value Rule*, 4 Hastings Sci. & Tech. L.J. 209, 226 (2012) (noting sensitivity to data collection methods and algorithms and the problem of combinatorial explosion); Lisa Cameron, Michael Cragg & Daniel McFadden, *The Role of Conjoint Surveys in Reasonable Royalty Cases*, Law360 (Oct. 16, 2013), <http://www.law360.com/articles/475390/the-role-of-conjoint-surveys-in-reasonable-royalty-cases>.

Courts have shown cautious receptivity to conjoint analysis. Recognizing the general admissibility of consumer surveys in *Oracle America, Inc. v. Google, Inc.*, No. C 10-03571 WHA, 2012 WL 850705, at *10 (N.D. Cal. Mar. 13, 2012), Judge Alsup nonetheless rejected some of Oracle’s expert’s conjoint analysis as unreliable while allowing some of it to be admitted. *Id.* *10–14. In *TV Interactive Data Corp. v. Sony Corp.*, 929 F. Supp. 2d 1006 (N.D. Cal. 2013), Magistrate Judge Joseph Spero held the patentee’s expert testimony using conjoint analysis to be admissible. *Id.* at 1019–25.

14.4.3.2.1.4.2 FRAND Licensing of Standard Essential Patents

A growing number of technologies arise within the context of network industries in which standard protocols and interfaces promote technological innovation and greater consumer value. Industry standard-setting organizations such as the Institute of Electrical Electronics Engineers (IEEE) and the International Telecommunication Union (ITU) bring together company representatives to develop industry standards. To ensure that the industry standards reflect the best technologies while avoiding (or at least postponing) licensing disputes, the participants typically commit to license standard-essential patents (SEPs) on “reasonable and non-discriminatory” (RAND) or “fair, reasonable and non-discriminatory” (FRAND) terms. The standard-setting organizations have typically left the parameters for determining FRAND license terms undefined, see Mark A. Lemley, *Intellectual Property Rights and Standard-Setting Organizations*, 90 Cal. L. Rev. 1889, 1906 (2002), leaving courts with the diffi-

cult task of determining licensing rates for highly complex products involving potentially hundreds of patents.

The valuation of SEPs presents distinct problems. Industry standards can encompass hundreds of patented technologies of carrying significance. Not surprisingly, owners of patents within a SEP pool often see their patents as particularly valuable, thereby risking hold-up and undue royalty stacking. The challenge lies in separating the value of the particular technology from the often tremendous value from standardization. Once consumers adopt a product, they become locked into the standard to varying degrees. This could provide the patentee tremendous leverage in a negotiation. With potentially hundreds of SEPs and dozens of patent owners, the problem becomes intractable if patent owners stake out aggressive positions or refuse to propose licensing terms.

In a series of recent cases, courts have surmounted this challenge by interpreting the principal goal of standard-setting agreements to be widespread adoption of the standard by barring FRAND licensors from capturing the coordination and network value of the standard. See § 14.4.3.2.1.4.2; *Commonwealth Sci. and Indus. Research Org. (CSIRO) v. Cisco Sys., Inc.*, 809 F.3d 1295 (Fed. Cir. 2015); *Microsoft Corp. v. Motorola, Inc.*, No. C10-1823JLR, 2013 U.S. Dist. LEXIS 60233, 2013 WL 2111217 (W.D. Wash. Apr. 25, 2013); see also *Ericsson*, 773 F.3d at 1229–35; *In re Innovatio IP Ventures LLC Patent Litig.*, No. 11 C 9308, 2013 U.S. Dist. LEXIS 144061, 2013 WL 5593609 (N.D. Ill. Oct. 3, 2013). The courts have adapted the *Georgia-Pacific* factors to serve the standard-setting context.

14.4.3.2.1.5 Marking

The Patent Act encourages patentees and persons who make, sell, or import any patented article to provide notice to the public by marking the article or, if the article cannot be marked, to label the package containing it with “patent” or “pat.” and the patent number. See § 287(a). To further facilitate marking, § 287 has been amended under the AIA to allow patentees to “virtually mark” a product by providing the address of a webpage containing a list of the patents covering the product. The virtual-marking provision became effective September 16, 2011, and applies to any case pending or filed on or after that date. AIA § 16.

While marking is not required for patent protection, the failure to mark may limit the award of damages unless the infringer was notified of the infringement and subsequently continued to infringe. In such a case, damages may be awarded only for infringing acts performed after such notice (which includes the filing of an infringement action). “Actual notice [under the second prong of § 287(a)] requires the affirmative communication of a specific charge of infringement by a specific accused product or device.” See *Amsted Indus. Inc. v. Buckeye Steel Castings Co.*, 24 F.3d 178, 187 (Fed. Cir. 1994). Mere notice of the patent itself or its ownership does not constitute sufficient notice for purposes of the actual notice prong of § 287(a). The notice inquiry must focus on the patentee’s actions as opposed to the infringer’s knowledge.

The marking provision of § 287(a) does not apply to patents claiming only processes or methods. See *Am. Med. Sys., Inc. v. Med. Eng’g Corp.*, 6 F.3d 1523, 1538

(Fed. Cir. 1993). Furthermore, the marking provisions do not apply to patents that contain both method and apparatus claims if the plaintiff elects to assert only the method claims in such patents. See *Crown Packaging Tech. v. Reexam Beverage Can, Co.*, 559 F.3d 1308 (Fed. Cir. 2009); *Hanson v. Alpine Valley Ski Area*, 718 F.2d 1082 (Fed. Cir. 1983). The provisions do apply, however, “[w]here the patent contains both apparatus and method claims . . . to the extent that there is a tangible item to mark by which notice of the asserted method claims can be given.” *Id.* at 1538–39.

Several district courts have interpreted the marking provision to apply to websites offering or running patented software. In *IMX, Inc. v. Lendingtree, LLC*, 79 U.S.P.Q.2d 1373, 2005 U.S. Dist. LEXIS 33179, 2005 WL 3465555 (D. Del. Dec. 14, 2005), *motion for reconsideration denied*, 2006 U.S. Dist. LEXIS 551, 2006 WL 47066 (D. Del. Jan. 10, 2006), the court held that Internet vendors of downloadable patented software must mark their websites in order to satisfy § 287(a): “[a]lthough IMX did not make or sell the computer components through which its patented system is processed, and although the IMX website itself was not the patented invention, nevertheless . . . the website is intrinsic to the patented system and constitutes a ‘tangible item to mark by which notice of the asserted method claims can be given.’” Similarly, the court in *Sovereign Software LLC v. Amazon.com, Inc.*, 383 F. Supp. 2d 904 (E.D. Tex. 2005), held that websites were “tangible items,” and thus the patentee was required to mark its websites in order to comply with the marking provision and establish entitlement to damages for willful infringement.

14.4.3.2.2 Enhanced Damages

Under § 284, the court may increase damages up to three times the compensatory award. An award of enhanced damages and the extent of the enhancement are within the court’s discretion. See *Read Corp. v. Portec, Inc.*, 970 F.2d 816, 826 (Fed. Cir. 1992), abrogated on other grounds; *Markman v. Westview Instruments, Inc.*, 52 F.3d 967 (Fed. Cir. 1995) (en banc). In *Halo Electronics, Inc. v. Pulse Electronics, Inc.*, 579 U.S. ____ (2016), the Supreme Court rejected as “unduly rigid” the two-prong test that the Federal Circuit adopted in *In re Seagate Technology, LLC*, 497 F.3d 1360 (Fed. Cir. 2007). *Seagate* had required a patentee to first “show by clear and convincing evidence that the infringer acted despite an objectively high likelihood that its actions constituted infringement of a valid patent,” and then “demonstrate that this objectively-defined risk . . . was either known or so obvious that it should have been known to the accused infringer.” *Id.* at 1371.

The Supreme Court did not adopt a specific test for enhanced damages, but rather gave broad guidelines within which the district court should exercise its discretion. Damages should not be enhanced in “garden-variety” infringement cases. They are “generally . . . reserved for egregious cases typified by willful misconduct,” such as “deliberate or wanton” infringement, “malicious pira[cy],” or objective recklessness. Nonetheless, willfulness is not a per se requirement for enhanced damages and enhanced damages need not follow a finding of egregious misconduct. *Halo*, slip op. at 11, 15. “[C]ourts should continue to take into account the particular circumstances of each case in deciding whether to award damages, and in what amount.” *Id.* Willful infringement must be proven by a preponderance of evidence, *id.* at 12, and usually

is based the infringer's knowledge and conduct at the time of infringement, not, for example, the merit of arguments later asserted in litigation, *id.* at 10.

14.4.3.2.3 Prejudgment Interest

Section 284 authorizes the patentee to recover prejudgment interest. The Supreme Court has held that prejudgment interest “should be awarded . . . absent some justification for withholding such an award.” *Gen. Motors Corp. v. Devex Corp.*, 461 U.S. 648, 657 (1983). The court may award prejudgment interest only on compensatory damages and not on enhanced damages. See *Underwater Devices Inc. v. Morrison-Knudsen Co.*, 717 F.2d 1380, 1389 (Fed. Cir. 1983), overruled on other grounds by *Knorr-Bremse Systeme Fuer Nutzfahrzeuge GmbH v. Dana Corp.*, 383 F.3d 1337 (Fed. Cir. 2004) (en banc), and *In re Seagate*, 497 F.3d 1360 (Fed. Cir. 2007) (en banc). Interest is calculated from the time of infringement until the date judgment is rendered. See *General Motors*, 461 U.S. at 656. The district court has substantial discretion to determine both the prejudgment interest rate and the assessment of simple or compound interest to the damages. See *Gyromat Corp. v. Champion Spark Plug Co.*, 735 F.2d 549, 556–57 (Fed. Cir. 1984).

14.4.3.3 Costs

The award of costs under § 284 refers to Federal Rule of Civil Procedure 54(d)(1), which provides that “costs other than attorneys’ fees shall be allowed as of course to the prevailing party unless the court otherwise directs.” Fed. R. Civ. P. 54(d)(1). Section 1920, title 28 of the U.S. Code, lists the types of costs the prevailing party may recover under Federal Rule of Civil Procedure 54(d)(1), some of which include court reporter fees, docket fees, and compensation for court-appointed experts.

14.4.3.4 Attorneys’ Fees

Section 285 provides that the “court in exceptional cases may award reasonable attorney fees to the prevailing party.” The Supreme Court has interpreted this standard to afford district judges discretion to award attorneys’ fees where it finds that the case “simply . . . stands out from others with respect to the substantive strength of a party’s litigating position . . . or the unreasonable manner in which the case was litigated.” *Octane Fitness LLC v. Icon Health & Fitness Inc.*, 134 S. Ct. 1749, 1755–76 (2014) (rejecting the Federal Circuit’s rule that a defendant may only be awarded fees where it demonstrates that the patentee litigated with subjective bad faith and that the suit was objectively baseless). The Court directed district courts to consider the totality of the circumstances. Such determinations are reviewable for abuse of discretion. *Highmark Inc. v. Allcare Health Mgmt. Sys., Inc.*, 134 S. Ct. 1744, 1749 (2014).

14.5 Other Patent-Related Causes of Action

This section provides an overview of other patent-related causes of action that do not relate to enforcement, such as false marking and civil actions challenging decisions of the USPTO's Patent Trial and Appeal Board (PTAB).

14.5.1 False Marking

While § 287 encourages the marking of patented products with the patent number, § 292 imposes a civil penalty for false marking. A party asserting false marking must show by a preponderance of the evidence that an unpatented article was marked with intent to deceive the public. *Forest Grp., Inc. v. Bon Tool Co.*, 590 F.3d 1295, 1300 (Fed. Cir. 2009). False marking claims must be pled with particularity under Federal Rule of Civil Procedure 9(b). *In re BP Lubricants USA Inc.*, 637 F.3d 1307, 1309 (Fed. Cir. 2011).

Prior to the enactment of the AIA on September 16, 2011, the false marking statute had been enforceable as a *qui tam* action, in which anyone may bring suit on behalf of the government and retain one-half of the recovery. As a response to the proliferation of false marking suits in recent years, the AIA amended § 292 to eliminate the *qui tam* provision so that only the U.S. government may sue to recover the statutory penalty. AIA § 16. In addition, private parties may bring false marking actions only if they have suffered a “competitive injury” as a result of false marking, and damages are limited to an amount “adequate to compensate for the injury.” *Id.* Marking with an expired patent number is no longer deemed a false marking violation. The amendment to § 292 became effective September 16, 2011, and applies to any case pending or filed on or after that date.

14.5.2 Civil Actions Under §§ 145 and 146

In most instances, a party dissatisfied with a PTAB decision files an appeal to the Federal Circuit under § 141. Alternatively, a party may challenge the PTAB decision in a civil action filed against the USPTO in federal district court. *See* §§ 145 (civil action to obtain patent), 146 (civil action for interference/derivation proceedings).

Actions brought under §§ 145 or 146 have a “hybrid” nature of an appeal and a trial de novo: while new evidence may be introduced, issues that were not raised during the USPTO proceedings cannot be raised in the district court action absent compelling circumstances. *Conservolite, Inc. v. Widmayer*, 21 F.3d 1098, 1102–03 (Fed. Cir. 1994). If a party introduces new evidence, the district court can make de novo findings with respect to factual issues to which the new evidence relates. *Mazzari v. Rogan*, 323 F.3d 1000, 1005 (Fed. Cir. 2003) (“If the parties choose to present additional evidence . . . the district court would make de novo factual findings if the evidence is conflicting.”). However, if no new evidence is introduced, the district court reviews the USPTO's fact findings under the “substantial evidence” standard of review. *Id.* at 1004–05.

In *Hyatt v. Kappos*, the Supreme Court unanimously held that parties may present new evidence in the district court action without regard to whether the evidence could have been presented during the USPTO proceeding. 132 S. Ct. 1690, 1700 (2012). In addition, the district court must make de novo factual findings based on the new evidence and evidentiary record from the USPTO. *Id.*

14.6 Appeals and Parallel Litigation

The blockbuster patent case can unfold before multiple judicial and quasi-judicial bodies. As discussed in §§ 14.2.5.5–6, parties can request the USPTO to reexamine issued patents. The following section discusses the appellate process and its consequences for patent cases as well as the various forms of parallel litigation that can occur.

14.6.1 Appeals to the Federal Circuit

In 1982, Congress created the U.S. Court of Appeals for the Federal Circuit and gave it exclusive jurisdiction over all appeals in patent cases. See 28 U.S.C. § 1295 (2000). The Federal Circuit was deemed necessary because patent cases were “inconsistently adjudicated,” which led to forum shopping. S. Rep. No. 97-275 at 5 (1981). Congress believed that unpredictability of patent law hampered technological innovation.

14.6.1.1 Appellate Jurisdiction

The Federal Circuit has jurisdiction over any final judgment of a district court if the district court’s jurisdiction was based on 28 U.S.C. § 1338. 28 U.S.C. § 1295(a)(1). Section 1338 in turn provides that the district courts have original, exclusive jurisdiction over cases arising under the Patent Act. See 28 U.S.C. § 1338(a).

14.6.1.2 Choice of Law

One of the many complications arising from patent cases stems from this “exclusive” subject-matter jurisdiction. Unlike other cases, patent cases involve inter-circuit choice-of-law questions because of the Federal Circuit’s subject matter, as opposed to regional, appellate jurisdiction. This limited jurisdiction has led the Federal Circuit to create a choice-of-law jurisprudence reminiscent of the *Erie* doctrine.

Where a question of law relates to the Federal Circuit’s exclusive patent-law jurisdiction, courts should apply Federal Circuit law. See *Lab. Corp. of Am. Holdings v. Chiron Corp.*, 384 F.3d 1326, 1330 (Fed. Cir. 2004) (regarding the interlocutory appealability of an injunction order). If not, courts should apply the regional circuit’s law. Hence, substantive matters like claim construction require the district court to follow Federal Circuit precedent. Procedural matters like whether a party waived an issue by not moving for judgment as a matter of law require the district court to apply its regional circuit’s precedent. Difficulties arise when courts face a procedural issue that potentially implicates a substantive patent law issue. Federal Circuit law

controls such an issue if “the issue pertains to patent law, if it bears an essential relationship to matters committed to [the Federal Circuit’s] exclusive control by statute, or if it clearly implicates the jurisprudential responsibilities of [the Federal Circuit] in a field within its exclusive jurisdiction.” *Midwest Indus., Inc. v. Karavan Trailers, Inc.*, 175 F.3d 1356, 1359 (Fed. Cir. 1999) (en banc in relevant part) (internal quotation marks omitted). The Federal Circuit decides whether an issue pertains to patent law on an issue-by-issue basis. See *Mars Inc. v. Kabushiki-Kaisha Nippon Conlux*, 24 F.3d 1368 (Fed. Cir. 1994).

Table 14.10 presents a sampling of the issues requiring choice-of-law analysis and the Federal Circuit’s rationale in deciding which law to apply. In general, if there is a cognizable argument that allowing differences in the procedural law will undermine the uniformity of patent law, the Federal Circuit will hold that its body of precedent controls the outcome.

Table 14.10
Choice of Law

Issue	Does Federal Circuit Law Govern?/Reasoning
Whether the district court had subject-matter jurisdiction to hear a claim of Japanese patent infringement. <i>Mars Inc. v. Kabushiki-Kaisha Nippon Conlux</i> , 24 F.3d 1368, 1371 (Fed. Cir. 1994).	Yes: “[The issue] is of importance to the development of the patent law and is clearly a matter that falls within the exclusive subject matter responsibility of this court.”
Whether a party waived its right to dispute the sufficiency of the evidence supporting the jury’s antitrust verdict. <i>Unitherm Food Sys. v. Swift-Eckrich, Inc.</i> , 375 F.3d 1341, 1365 n.7 (Fed. Cir. 2004), <i>rev’d on other grounds</i> , 546 U.S. 394 (2006).	No: “Because we decide antitrust issues that do not implicate patent law, including market definition, under the law of the regional circuits, . . . we similarly apply [regional circuit] law to determine whether or not [the party] has preserved its right to appeal.”
Whether an injunction against copending patent litigation in another district court is immediately appealable. <i>Lab. Corp. of Am. Holdings v. Chiron Corp.</i> , 384 F.3d 1326, 1330 (Fed. Cir. 2004).	Yes: “Because of the importance of national uniformity in patent cases, we hold that injunctions arbitrating between copending patent declaratory judgment and infringement cases in different district courts are reviewed under the law of the Federal Circuit.”

Prior to September 16, 2011, the well-pleaded complaint rule introduced an additional wrinkle to the choice-of-law analysis. Where the district court’s original jurisdiction did not stem from § 1338 because, for example, the plaintiff did not assert a patent claim, the Federal Circuit had no appellate jurisdiction and the district court was instead bound by its regional circuit law. This situation could arise where the patent case stemmed from the defendant’s counterclaim to a nonpatent cause of ac-

tion. *See, e.g., Holmes Grp., Inc. v. Vornado Air Circulation Sys., Inc.*, 535 U.S. 826 (2002). The AIA closed this gap in the Federal Circuit's jurisdiction by amending § 1295 so as to provide the Federal Circuit with exclusive jurisdiction over all patent appeals, including those cases where the patent-related cause of action exists only as a counterclaim. AIA § 19. This statutory amendment, which overrules the holding in *Holmes Group*, applies to actions filed on or after September 16, 2011.

14.6.1.3 Interlocutory Appeals

The Federal Circuit has appellate jurisdiction over any interlocutory appeal from a case based on the district court's original jurisdiction over patent cases. § 1292(c)(1). As with other federal courts of appeals, the Federal Circuit has discretion to decline an interlocutory appeal. *See, e.g., In re Convertible Rowing Exerciser Patent Litig.*, 903 F.2d 822 (Fed. Cir. 1990).

District courts most frequently encounter the question of interlocutory appealability with respect to claim construction issues. However, the Federal Circuit almost always refuses to entertain interlocutory appeals on claim construction orders. *See Nystrom v. TREX Co., Inc.*, 339 F.3d 1347, 1351 (Fed. Cir. 2003) ("Such appeals are rarely granted."). Nevertheless, the Federal Circuit may grant an appeal on a claim construction order if it already has jurisdiction over a prior claim construction order, for example, if a preliminary injunction is already on appeal. *See, e.g., Regents of the Univ. of Cal. v. Dako N. Am., Inc.*, 477 F.3d 1335 (Fed. Cir. 2007).

14.6.2 Parallel Litigation Forums

Some patent cases spawn parallel litigation, presenting a host of issues regarding stays and coordination of discovery that was dealt with in prior chapters. A district court should be aware of the potential for parallel litigation and where it might be filed.

14.6.2.1 International Trade Commission

Under 19 U.S.C. § 1337, the U.S. International Trade Commission (ITC) has jurisdiction to bar importation of articles that infringe a valid and enforceable U.S. patent (as well as other federal intellectual property rights). *See generally* Peter S. Menell, et al., Section 337 Patent Investigation Management Guide (Lexis 2012). The ITC has become increasingly popular over the past decade due to its speed and expertise in patent litigation. The typical ITC proceeding is completed in under eighteen months. Although the ITC may not award damages, it can issue exclusion orders preventing the importation of infringing goods into the United States.

ITC cases are heard by an administrative law judge (ALJ), who conducts an evidentiary hearing that resembles a bench trial. The ALJ's determinations are reviewed by the ITC's six-member commission, whose decisions are subject to review by the President. If the President fails to disapprove the ITC's determination within sixty days, it becomes final, and the losing party may file an appeal to the Federal Circuit.

Because ITC proceedings are governed by the Administrative Procedure Act, the Federal Circuit reviews the ITC's factual findings for substantial evidence and its legal conclusions de novo. 5 U.S.C. § 706(2)(A), (E). ITC decisions are not binding on district courts, and have no *res judicata* or collateral estoppel effect. *See Tex. Instruments v. Cypress Semiconductor Corp.*, 90 F.3d 1558, 1569 (Fed. Cir. 1996). Patent actions may proceed simultaneously in district court and in the ITC, especially if the patentee seeks both damages (only available in the district court) and an exclusion order (only available from the ITC). Under 28 U.S.C. § 1659(a), parties to a civil action that are also respondents in a parallel proceeding before the ITC can move for a stay of the district court proceedings as a matter of right. *See* § 2.2.6.2.1.

14.6.2.2 Patent Office Reexamination or Review

As discussed previously (*see* §§ 14.2.5.5–7) litigants can request that the USPTO reexamine or review the validity of issued patents. High-stakes patent litigation often leads to requests for reexamination or review to invalidate a patent or alter its scope. To avoid duplicative proceedings, district courts may decide to stay the litigation pending reexamination or review. *See* § 2.2.6.4.1.

14.6.2.3 Other District Courts and MDL Proceedings

Patent litigation can lead to the proverbial “race to the courthouse,” especially where declaratory judgment jurisdiction is available. In other instances, a defendant may choose to file a countersuit for infringement of its own patents in a different jurisdiction. Lastly, the Judicial Panel on Multidistrict Litigation occasionally consolidates patent cases nationwide before a single judge for pretrial proceedings. *See* § 2.2.6.3; U.S. Judicial Panel on Multidistrict Litigation, Pending MDLs, <http://www.jpml.uscourts.gov/pending-mdls-0>.

14.6.2.4 Foreign Courts

Complex patent litigation may be occurring simultaneously overseas because each nation operates its own patent system. While many nations have harmonized their patent laws to a significant extent, it is an abuse of discretion for a district judge to take jurisdiction over infringement claims based on other nation's patents. *See Voda v. Cordis Corp.*, 476 F.3d 887 (Fed. Cir. 2007). Indeed, the Federal Circuit's holding that the U.S. district courts cannot consolidate patent-infringement claims from multiple countries ensures that parallel litigation will occur over particularly valuable inventions. In such cases, district courts should be sensitive to the potential for strategic effects that certain types of motions (for example, regarding depositions or privileged documents) can create.

Appendix A

Patent Glossary

Note: Many of these definitions are derived from the USPTO glossary, available at <http://www.uspto.gov/main/glossary/index.html>.

abandonment: A patent application becomes abandoned for failure to file a complete and proper reply within the time period provided under 37 C.F.R. § 1.134 and § 1.136 unless an office action indicates otherwise. Abandonment may be either of the invention or of an application. An abandoned application, in accordance with 37 C.F.R. §§ 1.135 and 1.138, is one which is removed from the Patent Office docket of pending applications. *See* § 14.3.4.1.6.

abstract of the disclosure: A concise statement of the technical disclosure, including that which is new in the art to which the invention pertains.

agent (practitioner, representative): One who is not an attorney but is authorized to act for or in place of the applicant(s) before the USPTO, that is, an individual who is registered to practice before the USPTO.

all-limitation rule (all-elements rule): A doctrine requiring that an allegedly infringing device contain every element of a claim to establish infringement, either literally or under the doctrine of equivalents. *See* § 14.4.1.4.2.1.1.

analogous art (pertinent art, relevant art): In a nonobviousness analysis, art that a person having ordinary skill in the art would have consulted in attempting to solve the problem addressed by the innovation. Analogous art must be either within the same field of endeavor as the invention, or from a different field but reasonably pertinent to the same problem. *See* § 14.3.5.3.2.

antedate (swearing behind a reference): A procedure whereby a patent applicant can establish an invention date earlier than the effective date of prior art that has been cited against his claims in a rejection for non-obviousness (§ 103) or lack of novelty (§§ 102(a) or (e)).

anticipation: A single prior art reference anticipates a claim when it contains all the elements of the claim. The claim is rejected for lack of novelty under § 102.

assignment: A transfer of ownership of a patent application or patent from one entity to another. Record all assignments with the USPTO Assignment Services Division to maintain clear title to pending patent applications and patents.

benefit claim: The claiming by an applicant in a nonprovisional application of a benefit of an invention disclosed in a prior-filed, co-pending (under examination at

the same time), provisional, or nonprovisional application, or international application designating the United States for the purposes of securing an earlier effective filing date for the nonprovisional application.

best mode: The specification must set forth the best mode, or preferred embodiment, contemplated by the inventor at the time of filing, of making and using his or her invention (§ 112), or the patent may be declared invalid. *See* § 14.3.3.3. The AIA eliminated failure to set forth best mode as a basis for patent invalidity.

blocking patent: Two or more patented inventions block each other when one cannot be practiced without infringing the other, and vice versa. Blocking patents often arise when an improvement on an invention is patented: the improvement cannot be practiced without infringing the original patent, and the original inventor cannot practice the improvement without infringing the improvement patent. The parties commonly agree to a cross-license to resolve the issue.

central claiming: A claiming regime in which a claim recites the preferred embodiment of the invention but is deemed to cover a range of equivalents to that preferred embodiment.

Certificate of Correction: Minor errors in an issued patent can be corrected with a Certificate of Correction. *See* § 254 (correction of USPTO mistake); § 255 (correction of applicant mistake).

claim restriction: A discretely claimed component of a patent claim. *See also element.*

claim vitiation: An accused device cannot be infringing if it would effectively vitiate (or eliminate) any claim limitation. This doctrine is a corollary of the all-elements rule. *See* § 14.4.1.4.2.1.1.1.

claims: Claims delineate the patented invention. The patent specification must conclude with a claim or claims particularly pointing out and distinctly claiming the subject matter that the applicant regards as his or her invention or discovery.

classification: Patents are classified by a system using a three-digit class and a three-digit subclass to describe every similar grouping of patent art. Multiple classification codes may describe a single invention.

combination patent: A patent granted for an invention that unites existing components in a novel way.

composed of (used when defining the scope of a claim): A transitional phrase that is interpreted in the same manner as either *consisting of* or *consisting essentially of*, depending on the facts of the particular case.

comprising (used when defining the scope of a claim): A transitional phrase that is synonymous with *including*, *containing* or *characterized by*; is inclusive or open-ended and does not exclude additional, unrecited elements or method steps. *Comprising* is a term of art used in claim language that means that the named elements are essential in describing the invention.

conception: The formation in the mind of the inventor of the definite and permanent idea of the complete invention that is thereafter reduced to practice. See § 14.3.4.1.2.1.

consisting essentially of (used when defining the scope of a claim): A transitional phrase that limits the scope of a claim to the specified materials or steps and those that do not materially affect the basic and novel characteristics of the claimed invention. For the purposes of searching for and applying prior art under §§ 102 and 103, absent a clear indication in the specification or claims of what the basic and novel characteristics actually are, *consisting essentially of* will be construed as equivalent to *comprising*.

consisting of (used when defining the scope of a claim): A transitional phrase that is closed and excludes any element, step, or ingredient not specified in the claim.

continuation: A second application for the same invention claimed in a prior non-provisional application and filed before the first application becomes abandoned or patented.

continuation-in-part (CIP): An application filed during the lifetime of an earlier nonprovisional application that repeats some substantial portion or all of the earlier nonprovisional application and adds matter not disclosed in the earlier non-provisional application. See § 14.2.3.4.

contributory infringement: Section 271(c) imposes liability when a party “offers to sell or sell within the United States or imports into the United States a component of a patented machine, manufacture, combination or composition, or a material or apparatus for use in practicing a patented process, constituting a material part of the invention, knowing the same to be especially made or especially adapted for use in an infringement of such patent, and not a staple article or commodity of commerce suitable for substantial noninfringing use, shall be liable as a contributory infringer.” See § 14.4.1.3.2.

counterpart: An application filed in a foreign patent office that is substantially similar to the patent application filed with the USPTO and is based on some or all of the same invention. The two applications would generally have the same applicant.

covered business method review (CBMR): The America Invents Act instituted a variant of the postgrant review process for business method patents of all filing dates. Patent validity can be challenged on any ground, and covered business method review is broader than inter partes review. *See* § 14.2.5.8.1.

critical date: The date one year prior to the date a patent application is filed. The patent will be invalid for lack of novelty if the invention was in public use in the United States, or patented or described anywhere in the world, prior to the critical date. *See* § 102(b); § 14.3.4.1.5.

declaration (of inventor): A document in which an applicant for patent declares that he or she (1) made or authorized the application, (2) believes that he or she is the original inventor or an original joint inventor of a claimed invention in the application; and (3) acknowledges that any willful false statement made in the declaration is punishable under 18 U.S.C. § 1001 by fine or imprisonment of not more than five (5) years, or both. These requirements apply to applications filed after September 15, 2012. *See* M.P.E.P § 602.01(a)–(b). For applications filed prior to that date, the declaration also required the inventor’s country of citizenship. An oath or declaration must be filed in each nonprovisional patent application.

definiteness: Shorthand for the requirement, under § 112(b), that the claims particularly point out and distinctly claim the subject matter that the applicant regards as his or her invention. *See* § 14.3.3.4.

dependent claim: A claim that refers back to and further limits a preceding dependent or independent claim. A dependent claim includes by reference every limitation of the claim from which it depends.

derivation proceeding: The AIA established this new proceeding to allow an inventor to challenge an earlier-filed third-party application or patent claiming subject matter that was derived from the inventor’s own work. This proceeding partially substitutes for interference proceedings. *See* § 14.3.4.2.5.

design patent: A patent for a new, original, and ornamental design for an article of manufacture.

designation: A selection made by the applicant, in the Request for an International Application filed under the Patent Cooperation Treaty (PCT), as to the countries in which protection for an invention is desired.

diligence: To establish a conception date as the date of invention, the inventor must have worked diligently following conception to reduce the invention to practice. In the course of an interference, a party can establish its conception date as the date of invention by showing reasonable diligence from before the other’s conception until their own reduction to practice date. *See* § 102(g); § 14.3.4.1.2.3.

direct infringement: A person is liable for direct infringement if he or she “without authority makes, uses, offers to sell, or sells any patented invention, within the United States or imports into the United States any patented invention during the term of the patent therefore.” § 271(a). An accused infringer’s intent is immaterial, as patent infringement is a strict liability offense. *See* § 14.4.1.1.

disclaimer: There are two types of disclaimers under § 253: statutory disclaimers and terminal disclaimers. A patentee may make a statutory disclaimer of any complete claim, stating therein the extent of his or her interest in such patent. A patentee may make a terminal disclaimer to disclaim or dedicate to the public the remaining time of the term of the patent granted. A terminal disclaimer may be filed for the purpose of overcoming a judicially created double-patenting rejection. Disclaimers are required to be in writing and recorded in the USPTO, and are considered part of the original patent to the extent of the interest actually possessed by the disclaimant and by those claiming under him or her.

disclosure: In return for a patent, the inventor gives as consideration a complete disclosure of the invention for which protection is sought. *See* § 14.3.3.

divisional application: A later application for an independent or distinct invention disclosing and claiming only a portion of the subject matter disclosed in the earlier or parent application.

doctrine of equivalents: A judicially developed principle for finding patent infringement when the accused process or product falls outside the literal scope of the patent claims. The essential objective inquiry is: “Does the accused product or process contain elements equivalent to each claimed element of the patented invention?” *See* § 14.4.1.4.2.

double patenting: An inventor may not obtain claims in more than one patent directed either to the same invention or an obvious variation of the same invention. A rejection by the USPTO based on obviousness can be overcome by filing a terminal disclaimer stating that the additional patents will expire on the same date as the first patent. A terminal disclaimer, therefore, eliminates any improper extension of the initial patent term. *See* § 14.4.2.4.1.

effective filing date: The filing date of an earlier-filed application accorded under §§ 119/365(a)/365(b) (foreign filing or domestic provisional application), 120/365(c) (earlier U.S. filing date), or 121 (divisional applications), or if none of these sections is satisfied, the actual filing date of the patent.

electronic file wrapper: A system that provides a way to access electronic copies of the correspondence, documents, and other pertinent records used in considering a particular patent application.

element: A discretely claimed component of a patent claim. *See also claim restriction.*

embodiment: A manner in which an invention can be made, used, practiced, or expressed. *See best mode.*

enablement: The specification must describe in “full, clear, concise, and exact terms” how to make and use the invention such that any person skilled in the art can do so without undue experimentation. *See* § 14.3.3.2.

ex parte reexamination: A procedure whereby patentees and third parties can seek reexamination of issued patents. *See* § 14.2.5.5.2.

experimental use: Experimental use has two distinct meanings within patent law. First, experimental use is an exception to the public-use statutory bar under § 102(b). So long as the public use was to test or experiment with the invention, it is not counted in computing the one-year statutory bar. Second, experimental use is a defense to infringement and requires that the construction and use of the patented invention be for scientific purposes only. *See* § 14.3.4.1.5.1.

express abandonment: *See abandonment.*

file wrapper: The folder into which papers for a particular application are collected and maintained. It contains a complete record of proceedings in the USPTO from the filing of the initial patent application to the issued patent. The file wrapper of a patent application that is maintained by the USPTO is the official record.

file wrapper estoppel: *See prosecution history estoppel.*

filing date: The date of receipt in the USPTO of an application which includes (1) a specification containing a description and, if the application is a nonprovisional application, at least one claim, and (2) any required drawings.

final office action: A USPTO action on the second or any subsequent examination or consideration by an examiner that is intended to close the prosecution of a non-provisional patent application.

First Sale Doctrine/Exhaustion Principle: The first unrestricted sale of a patented product exhausts the patentee’s control over that product, and it can be resold and repaired without implicating the patent owner’s rights. This is a form of implied license. *See* § 14.4.2.2.1.1.

grace period: The one-year period between the critical date and the filing date, during which the invention may be offered for sale or used publicly in the United States,

or described in a printed publication or patented anywhere in the world without invalidating the patent under § 102(b).

Handgards claim: An antitrust counterclaim to a patent infringement suit, alleging that the patentee either knew the patent was invalid or was not being infringed. *See Handgards, Inc. v. Ethicon, Inc.*, 601 F.2d 986 (9th Cir. 1979).

having (used when defining the scope of a claim): A transitional phrase that is synonymous with *including*, *containing*, or *characterized by*; is inclusive or open-ended and does not exclude additional, unrecited elements or method steps.

improvement patent: A patent based on an improvement to a preexisting invention.

indefiniteness: *See definiteness.*

independent claim: A claim that does not refer back to or depend on another claim.

indirect infringement: Indirect infringement covers conduct by a person who assists or supports another's direct infringement of a patented invention. Direct infringement must be established as a predicate for each act of indirect infringement. *See* § 14.4.1.3.

inducement: Section 271(b) provides that “[w]hoever actively induces infringement of a patent shall be liable as an infringer.” A finding of inducement requires that a patent owner establish evidence of culpable conduct directed toward encouraging another's infringement. *See* § 14.4.1.3.1.

inequitable conduct: Where a patent applicant breaches the duty to prosecute a patent application in good faith and candor. *See* 37 C.F.R. § 1.56; *see also* § 14.4.2.3.1.

information disclosure statement (IDS): A list of patents, publications, U.S. applications, or other information submitted for consideration by the USPTO in a non-provisional patent application filed under § 111(a) to comply with applicant's duty to submit information that is material to the patentability of the claimed invention. *See* § 14.2.2.1.

inter partes reexamination: A procedure allowing third parties to seek invalidation by the USPTO of patents granted on applications filed on or after November 29, 1999. It was phased out beginning on September 16, 2011, and replaced by the AIA's inter partes review procedure. *See* § 14.2.5.5.3.

inter partes review (IPR): A procedure established by the AIA for third parties to seek invalidation of patents. *See* § 14.2.5.6.

interference: A proceeding, typically conducted before the Board of Patent Appeals and Interferences or in certain circumstances before a district court, to determine priority of invention between a pending application and/or one or more unexpired patents.

intervening rights: Claims that were modified at reissue, for any reason, are subject to a reliance-type interest (intervening rights). Third parties may rely on the claims of an issued patent. *See* § 14.2.5.4.2.2.

invention: Any art or process, machine, manufacture, design, or composition of matter, or any new and useful improvement thereof, or any variety of plant, which is or may be patentable under the patent laws of the United States.

invention date: The date either on which an invention is reduced to practice or conceived, so long as the inventor can show reasonable diligence from conception until reduction to practice.

issue date: The date that a patent application becomes a U.S. patent. The issue date is the date that patent rights can be exercised.

Jepson claim format: A claim containing a preamble explaining the current state of the art, followed by a description of the claimed patentable improvement.

joint infringement: Liability for joint infringement can be found only where one party controlled or directed each step in the process. *See* § 14.4.1.3.3.

joint inventor: An inventor who is named with at least one other inventor in a patent application, wherein each inventor contributes to the conception of the invention set forth in at least one claim in a patent application.

laches: An equitable defense that the plaintiff unreasonably delayed in asserting an infringement claim. If a patentee files suit more than six years after he or she became (or reasonably should have become) aware of the alleged infringement, a presumption of laches arises, and the patentee must establish legitimate reasons for the delay. This defense does not bar the plaintiff's action entirely, but prevents the recovery of any damages accrued prior to the filing of the action. *See* § 14.4.2.3.4.

license: An agreement between a patent owner and a licensee that the patent owner will not sue the licensee for acts that would otherwise constitute infringement.

limitation: A component of an invention described in a patent claim. *See element.*

literal infringement: Literal infringement requires an accused device to satisfy every element of the asserted patent claim precisely. *See* § 14.4.1.4.1.

Markush claim format: A *Markush* claim claims a genus of inventions in a single claim where the family of inventions all share a common trait, for example, “a chemical compound of the formula COOH-CH₂-R, where R is selected from the group consisting of _____.” *Markush* claims normally do not occur outside of the field of chemistry.

means-plus-function claim format: A means-plus-function claim defines one or more elements of the claim as a “means for [performing a function].” This special type of limitation is interpreted to cover the structure(s) described in the specification for performing the claimed function as well as equivalents of that/those structure(s) as of the time of filing. See § 112(f); § 14.4.1.4.1.1.

method claim: A claim covering a way of doing something, typically conveyed as a series of steps.

multiple dependent claim: A dependent claim that further limits and refers back in the alternative to more than one preceding independent or dependent claim. Acceptable multiple dependent claims shall refer to preceding claims using the terms *or, any one of, one of, any of, either*. A multiple dependent claim may not depend on another multiple dependent claim, either directly or indirectly.

national stage application: An application that has entered the national phase of the Patent Cooperation Treaty by the fulfillment of certain requirements in a national patent office. Such an application is filed under § 371 in the United States and is referred to as a “371 application.”

new matter: Information in an amendment to a pending patent that departs from the original disclosure. Under § 132, amendments cannot introduce new matter into the disclosure of the invention.

nonfinal office action: An office action made by the examiner where the applicant is entitled to reply and request reconsideration or further examination, with or without making an amendment.

nonobviousness: The requirement that to be patentable, an invention be sufficiently different from the prior art that, at the time it was made, it would not have been obvious to a person having ordinary skill in the art. See § 14.3.5.

nonpatent literature: Documents and publications that are not patents or published patent applications but are cited as references for being relevant in a patent prosecution. For example, a magazine article or doctoral thesis relevant to a claimed invention might be cited as nonpatent literature. Typically, references cited in an application are grouped into domestic patents and patent application publications, foreign patents, and nonpatent literature.

nonprovisional application: The “regular” type of patent applications, as distinct from provisional applications filed under § 111(b), often referred to simply as “applications.” *See* § 14.2.2.2.1.

nonresponsive amendment: An amendment filed by the applicant that does not fully respond to the examiner’s office action in accordance with 37 C.F.R. § 1.111.

normal publication: Regular 18-month publication or redacted publication of a nonprovisional application.

notice: The practice of marking a patented article with the word *patent* followed by the patent number. Without notice, the patentee may recover only for damages that occurred after the infringer received a charge of patent infringement.

notice of abandonment: A written notification from the USPTO that an application has been declared abandoned or, in other words, is no longer pending. If the application was abandoned unintentionally or due to USPTO error, the applicant has a deadline of two months from the issue date of the notice of abandonment to file either (1) a petition to revive the application or (2) a request to reinstate the application.

notice of allowance: A notification to the applicant that he or she is entitled to a patent under the law and requesting payment of a specified issue fee (and possibly a publication fee as well) within three months (non-extendable) from the mailing date of the notice of allowance.

notice of references cited (also known as a PTO-892 form): A list of relevant references cited by a patent examiner in an office action. The following are some examples of such references: domestic patents, domestic patent application publications, foreign patents or patent publications, publications, electronic documents, and affidavits.

novelty: The requirement under § 102 that an invention be sufficiently new relative to the prior art. *See* § 14.3.4.

oath: *See declaration (of inventor).*

obviousness: *See nonobviousness.*

office action: The patent examiner’s responses to the patent application and subsequent amendments.

on-sale bar: Section 102(b) specifies an on-sale bar, such that if an invention has been on sale for over one year, it is no longer patentable. *See* § 14.3.4.1.5.2.

opposition: A procedure allowing a third party to request a patent application's refusal or an issued patent's annulment.

original application: *Original* is used in the patent statute and rules to refer to an application that is not a reissue application. An original application may be a first filing or a continuing application.

parent application: The term *parent* is applied to an earlier application of the inventor disclosing a given invention.

patent: A quasi-property right granted by the government of the United States to an inventor "to exclude others from making, using, offering for sale, or selling the invention throughout the United States or importing the invention into the United States" for a limited time in exchange for public disclosure of the invention.

Patent Cooperation Treaty (PCT): A mechanism by which an applicant can file a single application that, when certain requirements have been fulfilled, is equivalent to a regular national filing in each designated country. There are currently over 130 PCT contracting states.

patent pending: A phrase that often appears on manufactured items. It means that someone has applied for a patent on an invention that is contained in the manufactured item. It serves as a warning that a patent may issue that would cover the item and that copiers should be careful because they might infringe if the patent issues. Once the patent issues, the patent owner will stop using the phrase "patent pending" and start using a phrase such as "covered by U.S. Patent Number XXXXXXXX."

patent term: The period of time during which a patent is enforceable. For patent applications filed after June 8, 1995, the expiration date is twenty years from the earliest effective filing date, subject to various extensions for delays occurring during prosecution and regulatory approval for drug-related patents. *See* § 14.2.4.

Patent Trial and Appeal Board (PTAB): The AIA created this administrative body to replace the Board of Patent Appeals and Interferences (BPAI). It hears appeals by a patent applicant from a USPTO patent examiner's final refusal to allow a patent application or adverse decision in an *ex parte* patent reexamination proceeding, *inter partes* and postgrant review proceedings filed by a party challenging the validity of an issued patent, derivation proceedings filed by a subsequent patent applicant claiming that an earlier patent applicant for the same invention derived the invention from the subsequent patent applicant, and interference proceedings to determine the first inventor of an invention commenced before September 16, 2012. PTAB decisions concerning *inter partes* and postgrant reviews and *ex parte* reexamination proceedings may be appealed only to the U.S. Court of Appeals for the Federal Circuit. In several circumstances, a civil action against the USPTO in the U.S. District Court for the Eastern District of Virginia may be instituted after a final

PTAB decision: (1) where a patent applicant is dissatisfied with a PTAB decision concerning the final rejection of the patent application unless the applicant has appealed to the Federal Circuit (*see* § 145); (2) in a derivation proceeding where the losing party initially filed a notice of appeal from the PTAB decision to the Federal Circuit, the adverse party may request that further proceedings instead be conducted in the Eastern District of Virginia (*see* AIA § 7); and (3) where a party is dissatisfied with the decision in an interference proceeding over which the PTAB has jurisdiction, unless that party has appealed to the Federal Circuit (*see* § 146).

peripheral claiming: A regime in which an applicant delineates the precise boundaries of the claimed area of exclusivity, in contrast to central claiming in which the applicant defines the claim directly.

person: For purposes of small entity determination, a person is defined as any inventor or other individual (e.g., an individual to whom an inventor has transferred some rights in the invention) who has not assigned, granted, conveyed, or licensed, and is under no obligation under contract or law to assign, grant, convey, or license any rights in the invention.

person having ordinary skill in the art (PHOSITA): A hypothetical person with knowledge of all analogous art from whose perspective nonobviousness, written description, and enablement are analyzed. *See* §§ 103, 112; *see also* §§ 14.3.3, 14.3.5.3.1.

petition to make special (PTMS): An applicant may petition the USPTO to examine his or her application ahead of other pending applications. A petition to make special may be granted on the basis of an inventor's age or poor health, that the patent will enable manufacture of the invention, is presently being infringed, relates to certain fields including superconductivity, HIV/AIDS, and counter-terrorism, or several other reasons.

post-grant review (PGR): Under this new procedure added by the AIA, third parties may file a petition seeking to cancel one or more patent claims within nine months of a patent's issue or reissue date. *See* § 14.2.5.8.

preferred embodiment: How the inventor sets forth the best mode for carrying out the claimed invention in the application.

printed publication: A reference that is sufficiently accessible to the public interested in the invention. *See* § 14.3.4.1.1.2.

prior art: The general category of technologies and events against which novelty and nonobviousness are evaluated. What qualifies as prior art is specified in §§ 102 and 103.

priority claim: Claims under §§ 119(a)–(e) and 120 for the benefit of the filing date of earlier filed applications.

priority date: The first filing of a patent application anywhere in the world describing an enabled invention usually establishes the priority date for that invention. *See* § 14.2.2.2.3.

pro se: Used to designate an independent inventor who has elected to file an application by himself or herself without the services of a licensed representative.

prosecution: The process for applying for and obtaining a patent from the USPTO.

prosecution history estoppel: A doctrine that prevents a patentee from obtaining coverage through the doctrine of equivalents over subject matter that was surrendered during prosecution. *See* § 14.4.1.4.2.1.2.

provisional application: A provisional application for patent is a U.S. national application for patent filed in the USPTO under § 111(b), which allows filing without a formal patent claim, oath or declaration, or any information disclosure (prior art) statement. A provisional application can establish an early effective filing date in a nonprovisional patent application filed under § 111(a) and automatically becomes abandoned after one year. It also allows the term *patent pending* to be applied. *See* § 14.2.2.2.4.

reads on: An accused device, manufacture, composition, or process “reads on” (and hence infringes) a patent claim if it embodies each of the claim limitations. Similarly, a patent claim “reads on” a prior art reference (and hence is invalid) if the prior art reference contains each of the claim limitations.

reasonable diligence: First-to-conceive inventor must have been reasonably diligent in working to reduce the invention to practice between the time “just prior” to the later inventor’s date of conception until the first-to-conceive inventor’s reduction to practice. Reasonable diligence is only at issue when the inventor was first to conceive but second to reduce to practice. *See* § 14.3.4.1.2.3.

recapture rule: Bars a patentee from seeking reissue claims that regain subject matter that was surrendered to obtain allowance during the original prosecution. *See* § 14.2.5.4.2.1. This rule is similar to prosecution history estoppel. *See* § 14.4.1.4.2.1.2.

record copy: Original copy of an international application filed under the Patent Cooperation Treaty maintained by the International Bureau of the World Intellectual Property Organization.

redacted publication: A patent application publication that omits material that was present in the specification or claims of the nonprovisional patent application filed in the USPTO. *See* 37 C.F.R. § 1.217 and MPEP § 1132.

reduction to practice: Following conception, reduction to practice is the final step in the inventive process. Reduction to practice can be actual (by constructing a physical embodiment of the invention) or constructive (by filing a patent application that satisfies the disclosure requirements of § 112). *See* § 14.3.4.1.2.2.

reexamination proceeding: At any time during the enforceability of a patent, any person may file a request for the USPTO to conduct a second examination of any claim of the patent on the basis of prior art patents or printed publications which that person states to be pertinent and applicable to the patent and believes to have a bearing on the patentability (*see* 37 C.F.R. § 1.501). For the request for reexamination to be granted, a substantial new question of patentability must be present with regard to at least one patent claim. The request must be in writing and must be accompanied by payment of a reexamination request filing fee as set forth in 37 C.F.R. § 1.20(c). *See* § 14.2.5.5.

reference: *See prior art.*

reissue application: An application for a patent to take the place of an unexpired patent that is defective in one or more particulars. Resissues may narrow or broaden the application. *See* § 14.2.5.4.

rejoinder: The returning to active consideration of claims previously withdrawn from consideration to due to a restriction requirement—i.e., a determination by the USPTO that an application contains more than one invention.

request for continued examination (RCE): A request filed in an application in which prosecution is closed (e.g., the application is under final rejection or a notice of allowance) that is filed to reopen prosecution and continue examination of the application.

restriction: If two or more independent and distinct inventions are claimed in a single application, the examiner may require the applicant to elect a single invention to which the claims will be restricted. This requirement is known as a requirement for restriction (also known as a requirement for division). Such requirement will normally be made before any action on the merits; however, it may be made at any time before final action (final rejection).

reverse doctrine of equivalents: A doctrine excusing infringement where an accused device literally infringes a patent, but should nonetheless be excused because it substantially differs in operative principle and results. Although it has not been applied in over a century to excuse infringement, it continues to be raised. *See* § 14.4.1.4.3.

specification: A written description of the invention and the manner and process of making and using the same.

statutory disclaimer: *See disclaimer.*

submarine patent: An informal term for a patent that is intentionally delayed in prosecution by the applicant to let an infringing user continue to develop its business, with the intention of claiming later-invented technology once the patent finally “surfaces” from the PTO. As of November 29, 2000, most patent applications must be published within eighteen months of filing, so submarine patents have become less common.

substitute patent application: An application that is, in essence, a duplicate of a prior application by the same applicant abandoned before the filing of the substitute application. A substitute application does not obtain the benefit of the filing date of the prior application.

supplemental Examination: A procedure added by the AIA authorizing a patentee to seek further consideration of additional information relevant to patentability. *See* § 14.2.5.3.

terminal disclaimer: *See disclaimer.*

utility: To be patentable, an invention must have specific, substantial, and credible utility. *See* § 14.3.2.

Walker Process claim: An antitrust counterclaim to a patent infringement suit, alleging that the patent was fraudulently obtained so as to exert monopolistic power and is therefore invalid. *See Walker Process Equip., Inc. v. Food Mach. & Chem. Corp.*, 382 U.S. 172 (1965).

written description: The portion of a patent specification, as required by § 112(a), describing the background of the invention, a summary of the invention, and a detailed description of the invention. The patentee must convey with reasonable clarity to those skilled in the art that, as of the filing date sought, he or she was in possession of the invention, and the written description must enable a person having ordinary skill in the art to practice the invention without undue experimentation. *See* § 14.3.3.1.

Appendix B

Acronyms

AIA: America Invents Act
AIPA: American Inventors Protection Act of 1999
AIPLA: American Intellectual Property Law Association
ANDA: Abbreviated New Drug Application
AOUSC: Administrative Office of the United States Courts
AU: (Group) Art Unit
BLA: Biologic License Application
BPAI: Board of Patent Appeals and Interferences
BPCIA: Biologics Price Competition and Innovation Act
CAPC: civil action to obtain patent certainty
CBM: covered business method
CBMR: covered business method review
CC: claim construction
CCPA: United States Court of Customs and Patent Appeals
CIP: continuation-in-part
CMC: case-management conference
CPA: continued prosecution application
CRU: Central Reexamination Unit
DOE: Doctrine of Equivalents
EAST: examiner automated search tools
EFD: effective filing date
EFS: electronic filing system
ePAS: Electronic Patent Assignment System
EPO: European Patent Office
ESD: examination support document
ESI: electronically stored information
FAR: Federal Acquisitions Regulations
FCBA: Federal Circuit Bar Association
FDA: Food and Drug Administration
FDCA: Food, Drug, and Cosmetic Act
FRAND: fair, reasonable and non-discriminatory
FTC: Federal Trade Commission
FTE: first-to-file
FTI: first-to-invent
GAU: Group Art Unit
IDS: information disclosure statement
INID: Internationally agreed Numbers for the Identification of bibliographic Data
IPR: inter partes review
IT: information technology
ITC: International Trade Commission

JMDL: Judicial Panel on Multidistrict Litigation
JSPR: joint preliminary status report
MDL: multidistrict litigation
MPEP: Manual of Patent Examining Procedure
MSJ: motion for summary judgment
NCE: new chemical entity
NDA: new drug application
NOA: notice of allowance
NPE: nonpracticing entity
NPL: non-patent literature
OG: Official Gazette
OIPE: Office of Initial Patent Examination
PAIR: Patent Application Information Retrieval
PCT: Patent Cooperation Treaty
PGR: postgrant review
PHOSITA: person having ordinary skill in the art
PHSA: Public Health and Safety Act
PLR(s): patent local rule(s)
PPA: Plant Patent Act
PTA: patent term adjustment
PTAB: Patent Trial and Appeal Board
PTE: patent term extension
PTMS: petition to make special
PTO: Patent and Trademark Office
PVP: plant variety protection
PVPA: Plant Variety Protection Act
RAND: reasonable and nondiscriminatory
RCE: request for continued examination
RCFC: Rules of the United States Court of Federal Claims
RLD: Reference Listed Drug
SEP: standard-essential patents
SNQ: substantial new question of patentability
SSO: standard setting organization
TD: terminal disclaimer
TSM: teaching, suggestion, or motivation
UPOV: Convention of the International Union for the Protection of New Plant Varieties
USITC: United States International Trade Commission
USPTO: United States Patent and Trademark Office
WIPO: World Intellectual Property Organization
WTO: World Trade Organization

Appendix C

Patent Resources

Organizations

ABA Section of Intellectual Property Law
<http://www.abanet.org/intelprop>

American Intellectual Property Law Association
<http://www.aipla.org/>

Federal Circuit Bar Association
<http://www.fedcirbar.org/olc/pub/LVFC/>

Intellectual Property Owners Association
<http://www.ipo.org>

Online Resources

Federal Judicial Center (Patent Law Resources)
<http://fjconline.fjc.dcn/node/253794>

<http://www.google.com/patents>

Manual of Patent Examining Procedure (MPEP)
<http://www.uspto.gov/web/offices/pac/mpep/mpep.htm>

Orange Book Blog (“At the Intersection of Patent and FDA Law”)
<http://www.orangebookblog.typepad.com/>

Patent Trade Office (Patent Full-Page Databases)
<http://patft.uspto.gov/>

PatentlyO (“The nation’s leading patent law blog”)
<http://www.patentlyo.com/>

Promote the Progress (“The patent education portal”)
<http://promotetheprogress.com/>

Publications

Anatomy of a Patent Case (American College of Trial Lawyers, 2d ed. 2012) (copies available to the federal judiciary from the Federal Judicial Center)

Donald S. Chisum, Chisum on Patents: A Treatise on the Law of Patentability, Validity, and Infringement (New York : LEXIS Pub., 1978)

Civil Litigation Management Manual (Judicial Conference of the United States, 2d ed. 2010) (208 pages) (copies available to the federal judiciary from the Federal Judicial Center)

This manual provides trial judges with a guide to managing civil cases. It sets out a wide array of case-management techniques, beginning with case filing and concluding

ing with steps for streamlining trials, and it discusses a number of special topics, including pro se and high-visibility cases, the role of staff, and automation that supports case management.

Effective Use of Courtroom Technology: A Judge's Guide to Pretrial and Trial (Federal Judicial Center 2001) (358 pages)

This publication, a joint project between the FJC and the National Institute for Trial Advocacy, describes the substantive and procedural considerations that may arise when lawyers bring electronic equipment to the courtroom or use court-provided equipment for displaying or playing evidentiary exhibits or illustrative aids during trial.

Federal Circuit Bar Journal (<http://www.law.gmu.edu/fcbj/>)

Robert J. Goldman, *Schwartz's Patent Law and Practice* (Bloomberg BNA 8th ed. 2015) (available online to the federal judiciary from the Federal Judicial Center at <http://fjconline.fjc.dcn>)

Manual for Complex Litigation, Fourth Edition (Federal Judicial Center 2004) (798 pages)

This manual describes approaches that trial judges have found useful in managing complex cases. This edition updates the treatment of electronic discovery and other aspects of pretrial management and describes major changes in the substantive and procedural law affecting case management in mass tort, class action, intellectual property, employment discrimination, and other types of litigation. A new chapter deals with managing scientific evidence.

Moy's Walker on Patents (4th ed., Thomson Reuters)

Barbara J. Rothstein, Ronald J. Hedges & Elizabeth C. Wiggins, *Managing Discovery of Electronic Information: A Pocket Guide for Judges* (Federal Judicial Center 2d ed. 2012) (40 pages)

This pocket guide covers issues unique to the discovery of electronically stored information (ESI), including its scope, the allocation of costs, the form of production, the waiver of privilege and work product protection, and the preservation of data and spoliation.

Video

The Patent Process: An Overview for Jurors (Federal Judicial Center 2013)

(17 minutes) (sample patent) (<https://www.youtube.com/watch?v=ax7QHQTbKQE>)

This brief video provides jurors in a patent case an explanation of what a patent is and the process for obtaining it. It has been carefully crafted, in consultation with judges and members of the bar, to present a balanced view of the patent process, but individual judges will want to review it carefully and consult with counsel before deciding whether to use it in a particular case. A sample patent, developed to accompany the video, is available at [http://www.fjc.gov/public/pdf.nsf/lookup/PatentSystemSample2.pdf/\\$file/PatentSystemSample2.pdf](http://www.fjc.gov/public/pdf.nsf/lookup/PatentSystemSample2.pdf/$file/PatentSystemSample2.pdf)

Appendix D

Patent Local Rules

Patent Local Rules (PLRs) date back to December 1, 2000, when the Northern District of California promulgated the first set of rules governing the content and timing of disclosures in patent cases. These rules established a default regime for operationalizing the claim construction process that developed following the Supreme Court's decision in *Markman v. Westview Instruments*, 515 U.S. 1192 (1995). See generally James Ware & Brian Davy, *The History, Content, Application, and Influence of the Northern District of California's Patent Local Rules*, 25 Santa Clara Computer & High Tech. L.J. 965 (2009). The Northern District of California has since updated its PLRs. Thirty-one district courts now have some form of Patent Local Rules. Many follow the Northern District of California model. Some districts have augmented the model to address distinctive aspects of their docket. For example, the District of New Jersey, which is home to many pharmaceutical companies, developed rules specific to Hatch-Waxman ANDA cases. Other districts, such as the District of Massachusetts, implement somewhat different approaches. Some districts also include model scheduling orders and protective orders in their local rules. This appendix lists the PLRs that have been implemented as of March 11, 2015. The documents in bold are contained herein.

California

- **Northern District (last updated Nov. 1, 2014)**
- Southern District (last updated Feb. 2, 2015)

Colorado (adopted Aug. 1, 2014)

Delaware

- **Chief Judge Stark scheduling order (non-ANDA issued June 2014, ANDA issued July 1, 2014) — included in Chapter 7 (non-ANDA), Chapter 10 (ANDA)**
- Judge Robinson scheduling order (last updated Feb. 5, 2015)
- Judge Sleet scheduling order (patent) (last updated Feb. 25, 2014)
- Judge Andrews Rule 16 patent scheduling order (last updated April 2012)

Georgia

- Northern District (effective July 15, 2004)

Idaho (revised Jan. 2, 2015)

Illinois

- Northern District (last updated Apr. 28, 2015)

Indiana

- Northern District (last updated Aug. 15, 2014)
- Southern District Patent Case Management Plan (revised Nov. 3, 2014)

Maryland (revised July 1, 2014)

Massachusetts (updated through Jan. 6, 2015)

Minnesota: uses Form 4 for patent cases (special Rule 26(f) report) (last updated May 14, 2013)

Missouri

- Eastern District (effective Jan. 1, 2011)

Nevada (effective Aug. 1, 2011)

New Hampshire (last updated Dec. 1, 2013)

New Jersey (last updated Apr. 3, 2014)

New York

- Eastern District (effective Apr. 8, 2013)
- Northern District (effective Jan. 1, 2012)
- Southern District (updated Jan. 30, 2015)

North Carolina

- Eastern District (last updated Aug. 2013)
- Middle District (last updated Mar. 1, 2014)
- Western District (effective Mar. 31, 2011)

Ohio

- Northern District (effective Oct. 22, 2009)
- Southern District (effective June 1, 2010)

Pennsylvania

- Western District (effective Dec. 1, 2009)

Tennessee

- Western District (last updated Jan. 1, 2014)

Texas

- **Eastern District (last updated May 19, 2015)**
- Northern District (Dallas Div.) (last updated Dec. 1, 2009)
- Southern District (last updated Dec. 1, 2009)

Utah (effective Dec. 1, 2013)

Washington

- Eastern District (effective Nov. 10, 2010)
- Western District (effective Jan. 1, 2009)

The website localpatentrules.com provides many useful comparisons between the rules, as well as updated copies of the rules. Many of these districts additionally have blogs covering changes to their local rules, including patent local rules. The best source for checking for updates to patent local rules remains the official website of each district court of interest.

The Northern District of California and the District of New Jersey have similar rules in many areas. Both jurisdictions require infringement claim charts and enforce § 271 rules and § 101 defenses on invalidity contentions in the same way. The jurisdictions differ in the required timing for infringement and invalidity contentions, as well as rules for document disclosure and claim construction.

In addition, several federal districts are known as “rocket dockets”—districts in which cases are typically disposed of much faster than in other federal districts. Typically these districts have special rules for handling patent cases, go to trial within a year of filing the complaint, are willing to resolve cases on summary judgment motions, and tend to view discovery disputes harshly. The Eastern District of Texas, Eastern District of Virginia, and the Western District of Wisconsin are commonly viewed as rocket dockets (along with the International Trade Commission). Many of these districts have judges who establish standing orders to move cases forward in a rapid fashion, and the local rules in these jurisdictions (even if not specific to patents) tend to support efficient management of the docket.

However, each venue is unique. In the Eastern District of Texas, local counsel is generally needed, and the local patent rules must be observed. Notably, infringement contentions are due no later than ten days before the initial case-management conference. The Western District of Wisconsin does not have local patent rules, but judges do have specific procedures for patent cases—including mandating that infringement contentions be served within five weeks of the first scheduling confer-

ence. In the Eastern District of Virginia, all cases proceed quickly, and there are no specific rules for patent cases.

UNITED STATES DISTRICT COURT
Northern District of California

PATENT LOCAL RULES

TABLE OF CONTENTS

1. SCOPE OF RULES	6
1-1. Title	6
1-2. Scope and Construction	6
1-3. Modification of these Rules	6
1-4. Effective Date	6
2. GENERAL PROVISIONS	7
2-1. Governing Procedure	7
(a) Notice of Pendency of Other Action Involving Same Patent	7
(b) Initial Case Management Conference	7
2-2. Confidentiality	8
2-3. Certification of Disclosures	8
2-4. Admissibility of Disclosures	8
2-5. Relationship to Federal Rules of Civil Procedure	8
3. PATENT DISCLOSURES	9
3-1. Disclosure of Asserted Claims and Infringement Contentions	9
3-2. Document Production Accompanying Disclosure	10
3-3. Invalidity Contentions	11
3-4. Document Production Accompanying Invalidity Contentions	12
3-5. Disclosure Requirement in Patent Cases for Declaratory Judgment of Invalidity	12
(a) Invalidity Contentions If No Claim of Infringement	12
(b) Inapplicability of Rule	12
3-6. Amendment to Contentions	12
3-7. Advice of Counsel	13
4. CLAIM CONSTRUCTION PROCEEDINGS	13
4-1. Exchange of Proposed Terms for Construction	13
4-2. Exchange of Preliminary Claim Constructions and Extrinsic Evidence . 14	
4-3. Joint Claim Construction and Prehearing Statement	14
4-4. Completion of Claim Construction Discovery	15
4-5. Claim Construction Briefs	15
4-6. Claim Construction Hearing	16
4-7. Good Faith Participation	16

1. SCOPE OF RULES

1-1. Title

These are the Local Rules of Practice for Patent Cases before the United States District Court for the Northern District of California. They should be cited as “Patent L.R. ___.”

1-2. Scope and Construction

These rules apply to all civil actions filed in or transferred to this Court which allege infringement of a utility patent in a complaint, counterclaim, cross-claim or third party claim, or which seek a declaratory judgment that a utility patent is not infringed, is invalid or is unenforceable. The Civil Local Rules of this Court shall also apply to such actions, except to the extent that they are inconsistent with these Patent Local Rules. If the filings or actions in a case do not trigger the application of these Patent Local Rules under the terms set forth herein, the parties shall, as soon as such circumstances become known, meet and confer for the purpose of agreeing on the application of these Patent Local Rules to the case and promptly report the results of the meet and confer to the Court.

1-3. Modification of these Rules

The Court may modify the obligations or deadlines set forth in these Patent Local Rules based on the circumstances of any particular case, including, without limitation, the simplicity or complexity of the case as shown by the patents, claims, products, or parties involved. Such modifications shall, in most cases, be made at the initial case management conference, but may be made at other times upon a showing of good cause. In advance of submission of any request for a modification, the parties shall meet and confer for purposes of reaching an agreement, if possible, upon any modification.

1-4. Effective Date

These Patent Local Rules take effect on December 1, 2009. They govern patent cases filed on or after that date. For actions pending prior to December 1, 2009, the provisions of the Patent Local Rules that were in effect on November 30, 2009, shall apply, except that the time periods for actions pending before December 1, 2009 shall be those set forth in and computed as in the Federal Rules of Civil Procedure and the Patent Local Rules that took effect on December 1, 2009.

2. GENERAL PROVISIONS

2-1. Governing Procedure

(a) Notice of Pendency of Other Action Involving Same Patent.

- (1) When actions concerning the same patent are filed within two years of each other by the same plaintiff, they will be deemed related.
- (2) Whenever a party knows or learns that actions concerning the same patent have been filed within two years of each other by the same plaintiff, the party must promptly file in each such case A Notice of Pendency of Other Action Involving Same Patent.
- (3) Pursuant to the Assignment Plan, the Clerk will reassign the related higher-numbered cases to the Judge assigned to the lowest-numbered case and will file the appropriate notification on the docket of each reassigned case.
- (4) If the Judge determines that the reassignment is not in compliance with subsection (1), the Judge may refer the matter to the Executive Committee for resolution.
- (5) Even if a case is not deemed related to a pending case pursuant to this rule, a party may still seek a related case determination pursuant to Civil L.R. 3-12.
- (6) If the lowest-numbered case is assigned to a magistrate judge to whom the parties have consented to preside over the action, the magistrate judge will retain that case even if consent is not entered in higher-numbered cases deemed related pursuant to subsection (1).

(b) Initial Case Management Conference. When the parties confer pursuant to Fed. R. Civ. P. 26(f), in addition to the matters covered by Fed. R. Civ. P. 26, the parties shall discuss and address in the Case Management Statement filed pursuant to Fed. R. Civ. P. 26(f) and Civil L.R. 16-9, the following topics:

- (1) Proposed modification of the obligations or deadlines set forth in these Patent Local Rules to ensure that they are suitable for the circumstances of the particular case (see Patent L.R. 1-3);
- (2) The scope and timing of any claim construction discovery including disclosure of and discovery from any expert witness permitted by the court;
- (3) The format of the Claim Construction Hearing, including whether the Court will hear live testimony, the order of presentation, and the estimated length of the hearing; and

- (4) How the parties intend to educate the court on the technology at issue.

2-2. Confidentiality

Discovery cannot be withheld on the basis of confidentiality absent Court order. The Protective Order authorized by the Northern District of California shall govern discovery unless the Court enters a different protective order. The approved Protective Order can be found on the Court's website.

2-3. Certification of Disclosures

All statements, disclosures, or charts filed or served in accordance with these Patent Local Rules shall be dated and signed by counsel of record. Counsel's signature shall constitute a certification that to the best of his or her knowledge, information, and belief, formed after an inquiry that is reasonable under the circumstances, the information contained in the statement, disclosure, or chart is complete and correct at the time it is made.

2-4. Admissibility of Disclosures

Statements, disclosures, or charts governed by these Patent Local Rules are admissible to the extent permitted by the Federal Rules of Evidence or Procedure. However, the statements and disclosures provided for in Patent L.R. 4-1 and 4-2 are not admissible for any purpose other than in connection with motions seeking an extension or modification of the time periods within which actions contemplated by these Patent Local Rules shall be taken.

2-5. Relationship to Federal Rules of Civil Procedure

Except as provided in this paragraph or as otherwise ordered, it shall not be a ground for objecting to an opposing party's discovery request (e.g., interrogatory, document request, request for admission, deposition question) or declining to provide information otherwise required to be disclosed pursuant to Fed. R. Civ. P. 26(a)(1) that the discovery request or disclosure requirement is premature in light of, or otherwise conflicts with, these Patent Local Rules, absent other legitimate objection. A party may object, however, to responding to the following categories of discovery requests (or decline to provide information in its initial disclosures under Fed. R. Civ. P. 26(a)(1)) on the ground that they are premature in light of the timetable provided in the Patent Local Rules:

- (a) Requests seeking to elicit a party's claim construction position;

- (b) Requests seeking to elicit from the patent claimant a comparison of the asserted claims and the accused apparatus, product, device, process, method, act, or other instrumentality;
- (c) Requests seeking to elicit from an accused infringer a comparison of the asserted claims and the prior art; and
- (d) Requests seeking to elicit from an accused infringer the identification of any advice of counsel, and related documents.

Where a party properly objects to a discovery request (or declines to provide information in its initial disclosures under Fed. R. Civ. P. 26(a)(1)) as set forth above, that party shall provide the requested information on the date on which it is required to be provided to an opposing party under these Patent Local Rules or as set by the Court, unless there exists another legitimate ground for objection.

3. PATENT DISCLOSURES

3-1. Disclosure of Asserted Claims and Infringement Contentions

Not later than 14 days after the Initial Case Management Conference, a party claiming patent infringement shall serve on all parties a “Disclosure of Asserted Claims and Infringement Contentions.” Separately for each opposing party, the “Disclosure of Asserted Claims and Infringement Contentions” shall contain the following information:

- (a) Each claim of each patent in suit that is allegedly infringed by each opposing party, including for each claim the applicable statutory subsections of 35 U.S.C. § 271 asserted;
- (b) Separately for each asserted claim, each accused apparatus, product, device, process, method, act, or other instrumentality (“Accused Instrumentality”) of each opposing party of which the party is aware. This identification shall be as specific as possible. Each product, device, and apparatus shall be identified by name or model number, if known. Each method or process shall be identified by name, if known, or by any product, device, or apparatus which, when used, allegedly results in the practice of the claimed method or process;
- (c) A chart identifying specifically where each limitation of each asserted claim is found within each Accused Instrumentality, including for each limitation that such party contends is governed by 35 U.S.C. § 112(6), the identity of the structure(s), act(s), or material(s) in the Accused Instrumentality that performs the claimed function.
- (d) For each claim which is alleged to have been indirectly infringed, an identification of any direct infringement and a description of the acts of the alleged indirect infringer that contribute to or are induc-

ing that direct infringement. Insofar as alleged direct infringement is based on joint acts of multiple parties, the role of each such party in the direct infringement must be described.

- (e) Whether each limitation of each asserted claim is alleged to be literally present or present under the doctrine of equivalents in the Accused Instrumentality;
- (f) For any patent that claims priority to an earlier application, the priority date to which each asserted claim allegedly is entitled; and
- (g) If a party claiming patent infringement wishes to preserve the right to rely, for any purpose, on the assertion that its own apparatus, product, device, process, method, act, or other instrumentality practices the claimed invention, the party shall identify, separately for each asserted claim, each such apparatus, product, device, process, method, act, or other instrumentality that incorporates or reflects that particular claim.
- (h) If a party claiming patent infringement alleges willful infringement, the basis for such allegation.

3-2. Document Production Accompanying Disclosure

With the “Disclosure of Asserted Claims and Infringement Contentions,” the party claiming patent infringement shall produce to each opposing party or make available for inspection and copying:

- (a) Documents (e.g., contracts, purchase orders, invoices, advertisements, marketing materials, offer letters, beta site testing agreements, and third party or joint development agreements) sufficient to evidence each discussion with, disclosure to, or other manner of providing to a third party, or sale of or offer to sell, or any public use of, the claimed invention prior to the date of application for the patent in suit. A party’s production of a document as required herein shall not constitute an admission that such document evidences or is prior art under 35 U.S.C. § 102;
- (b) All documents evidencing the conception, reduction to practice, design, and development of each claimed invention, which were created on or before the date of application for the patent in suit or the priority date identified pursuant to Patent L.R. 3-1(f), whichever is earlier;
- (c) A copy of the file history for each patent in suit; and
- (d) All documents evidencing ownership of the patent rights by the party asserting patent infringement.

- (e) If a party identifies instrumentalities pursuant to Patent L.R. 3-1(g), documents sufficient to show the operation of any aspects or elements of such instrumentalities the patent claimant relies upon as embodying any asserted claims.

The producing party shall separately identify by production number which documents correspond to each category.

3-3. Invalidity Contentions

Not later than 45 days after service upon it of the “Disclosure of Asserted Claims and Infringement Contentions,” each party opposing a claim of patent infringement, shall serve on all parties its “Invalidity Contentions” which shall contain the following information:

- (a) The identity of each item of prior art that allegedly anticipates each asserted claim or renders it obvious. Each prior art patent shall be identified by its number, country of origin, and date of issue. Each prior art publication shall be identified by its title, date of publication, and where feasible, author and publisher. Prior art under 35 U.S.C. § 102(b) shall be identified by specifying the item offered for sale or publicly used or known, the date the offer or use took place or the information became known, and the identity of the person or entity which made the use or which made and received the offer, or the person or entity which made the information known or to whom it was made known. Prior art under 35 U.S.C. § 102(f) shall be identified by providing the name of the person(s) from whom and the circumstances under which the invention or any part of it was derived. Prior art under 35 U.S.C. § 102(g) shall be identified by providing the identities of the person(s) or entities involved in and the circumstances surrounding the making of the invention before the patent applicant(s);
- (b) Whether each item of prior art anticipates each asserted claim or renders it obvious. If obviousness is alleged, an explanation of why the prior art renders the asserted claim obvious, including an identification of any combinations of prior art showing obviousness;
- (c) A chart identifying where specifically in each alleged item of prior art each limitation of each asserted claim is found, including for each limitation that such party contends is governed by 35 U.S.C. § 112(6), the identity of the structure(s), act(s), or material(s) in each item of prior art that performs the claimed function; and
- (d) Any grounds of invalidity based on 35 U.S.C. § 101, indefiniteness under 35 U.S.C. § 112(2) or enablement or written description under 35 U.S.C. § 112(1) of any of the asserted claims.

3-4. Document Production Accompanying Invalidity Contentions

With the “Invalidity Contentions,” the party opposing a claim of patent infringement shall produce or make available for inspection and copying:

- (a) Source code, specifications, schematics, flow charts, artwork, formulas, or other documentation sufficient to show the operation of any aspects or elements of an Accused Instrumentality identified by the patent claimant in its Patent L.R. 3-1(c) chart; and
- (b) A copy or sample of the prior art identified pursuant to Patent L.R. 3-3(a) which does not appear in the file history of the patent(s) at issue. To the extent any such item is not in English, an English translation of the portion(s) relied upon shall be produced.

The producing party shall separately identify by production number which documents correspond to each category.

3-5. Disclosure Requirement in Patent Cases for Declaratory Judgment of Invalidity

- (a) **Invalidity Contentions If No Claim of Infringement.** In all cases in which a party files a complaint or other pleading seeking a declaratory judgment that a patent is invalid Patent L.R. 3-1 and 3-2 shall not apply unless and until a claim for patent infringement is made by a party. If the defendant does not assert a claim for patent infringement in its answer to the complaint, no later than 14 days after the defendant serves its answer, or 14 days after the Initial Case Management Conference, whichever is later, the party seeking a declaratory judgment of invalidity shall serve upon each opposing party its Invalidity Contentions that conform to Patent L.R. 3-3 and produce or make available for inspection and copying the documents described in Patent L.R. 3-4.
- (b) **Inapplicability of Rule.** This Patent L.R. 3-5 shall not apply to cases in which a request for a declaratory judgment that a patent is invalid is filed in response to a complaint for infringement of the same patent.

3-6. Amendment to Contentions

Amendment of the Infringement Contentions or the Invalidity Contentions may be made only by order of the Court upon a timely showing of good cause. Non-exhaustive examples of circumstances that may, absent undue prejudice to the non-moving party, support a finding of good cause include:

- (a) A claim construction by the Court different from that proposed by the party seeking amendment;

- (b) Recent discovery of material, prior art despite earlier diligent search; and
- (c) Recent discovery of nonpublic information about the Accused Instrumentality which was not discovered, despite diligent efforts, before the service of the Infringement Contentions.

The duty to supplement discovery responses does not excuse the need to obtain leave of court to amend contentions.

3-7. Advice of Counsel

Not later than 50 days after service by the Court of its Claim Construction Ruling, each party relying upon advice of counsel as part of a patent-related claim or defense for any reason shall:

- (a) Produce or make available for inspection and copying any written advice and documents related thereto for which the attorney-client and work product protection have been waived;
- (b) Provide a written summary of any oral advice and produce or make available for inspection and copying that summary and documents related thereto for which the attorney-client and work product protection have been waived; and
- (c) Serve a privilege log identifying any other documents, except those authored by counsel acting solely as trial counsel, relating to the subject matter of the advice which the party is withholding on the grounds of attorney-client privilege or work product protection.

A party who does not comply with the requirements of this Patent L.R. 3-7 shall not be permitted to rely on advice of counsel for any purpose absent a stipulation of all parties or by order of the Court.

4. CLAIM CONSTRUCTION PROCEEDINGS

4-1. Exchange of Proposed Terms for Construction

- (a) Not later than 14 days after service of the “Invalidity Contentions” pursuant to Patent L.R. 3-3, not later than 42 days after service upon it of the “Disclosure of Asserted Claims and Infringement Contentions” in those actions where validity is not at issue (and Patent L.R. 3-3 does not apply), or, in all cases in which a party files a complaint or other pleading seeking a declaratory judgment not based on validity, not later than 14 days after the defendant serves an answer that does not assert a claim for patent infringement (and Patent L.R. 3-1 does not apply), each party shall serve on each other party a list of claim terms which that party contends should be construed by the Court, and identify any claim term which that party contends should be governed by 35 U.S.C. § 112(6).

- (b) The parties shall thereafter meet and confer for the purposes of limiting the terms in dispute by narrowing or resolving differences and facilitating the ultimate preparation of a Joint Claim Construction and Prehearing Statement. The parties shall also jointly identify the 10 terms likely to be most significant to resolving the parties' dispute, including those terms for which construction may be case or claim dispositive.

4-2. Exchange of Preliminary Claim Constructions and Extrinsic Evidence

- (a) Not later than 21 days after the exchange of the lists pursuant to Patent L.R. 4-1, the parties shall simultaneously exchange proposed constructions of each term identified by either party for claim construction. Each such "Preliminary Claim Construction" shall also, for each term which any party contends is governed by 35 U.S.C. § 112(6), identify the structure(s), act(s), or material(s) corresponding to that term's function.
- (b) At the same time the parties exchange their respective "Preliminary Claim Constructions," each party shall also identify all references from the specification or prosecution history that support its proposed construction and designate any supporting extrinsic evidence including, without limitation, dictionary definitions, citations to learned treatises and prior art, and testimony of percipient and expert witnesses. Extrinsic evidence shall be identified by production number or by producing a copy if not previously produced. With respect to any supporting witness, percipient or expert, the identifying party shall also provide a description of the substance of that witness' proposed testimony that includes a listing of any opinions to be rendered in connection with claim construction.
- (c) The parties shall thereafter meet and confer for the purposes of narrowing the issues and finalizing preparation of a Joint Claim Construction and Prehearing Statement.

4-3. Joint Claim Construction and Prehearing Statement

Not later than 60 days after service of the "Invalidity Contentions," the parties shall complete and file a Joint Claim Construction and Prehearing Statement, which shall contain the following information:

- (a) The construction of those terms on which the parties agree;
- (b) Each party's proposed construction of each disputed term, together with an identification of all references from the specification or prosecution history that support that construction, and an identification of any extrinsic evidence known to the party on which it intends to rely either to support its proposed construction or to oppose any other party's proposed construction, including, but not

limited to, as permitted by law, dictionary definitions, citations to learned treatises and prior art, and testimony of percipient and expert witnesses;

- (c) An identification of the terms whose construction will be most significant to the resolution of the case up to a maximum of 10. The parties shall also identify any term among the 10 whose construction will be case or claim dispositive. If the parties cannot agree on the 10 most significant terms, the parties shall identify the ones which they do agree are most significant and then they may evenly divide the remainder with each party identifying what it believes are the remaining most significant terms. However, the total terms identified by all parties as most significant cannot exceed 10. For example, in a case involving two parties, if the parties agree upon the identification of five terms as most significant, each may only identify two additional terms as most significant; if the parties agree upon eight such terms, each party may only identify only one additional term as most significant.
- (d) The anticipated length of time necessary for the Claim Construction Hearing;
- (e) Whether any party proposes to call one or more witnesses at the Claim Construction Hearing, the identity of each such witness, and for each witness, a summary of his or her testimony including, for any expert, each opinion to be offered related to claim construction.

4-4. Completion of Claim Construction Discovery

Not later than 30 days after service and filing of the Joint Claim Construction and Prehearing Statement, the parties shall complete all discovery relating to claim construction, including any depositions with respect to claim construction of any witnesses, including experts, identified in the Preliminary Claim Construction statement (Patent L.R. 4-2) or Joint Claim Construction and Prehearing Statement (Patent L.R. 4-3).

4-5. Claim Construction Briefs

- (a) Not later than 45 days after serving and filing the Joint Claim Construction and Prehearing Statement, the party claiming patent infringement, or the party asserting invalidity if there is no infringement issue present in the case, shall serve and file an opening brief and any evidence supporting its claim construction.
- (b) Not later than 14 days after service upon it of an opening brief, each opposing party shall serve and file its responsive brief and supporting evidence.

- (c) Not later than 7 days after service upon it of a responsive brief, the party claiming patent infringement, or the party asserting invalidity if there is no infringement issue present in the case, shall serve and file any reply brief and any evidence directly rebutting the supporting evidence contained in an opposing party's response.

4-6. Claim Construction Hearing

Subject to the convenience of the Court's calendar, two weeks following submission of the reply brief specified in Patent L.R. 4-5(c), the Court shall conduct a Claim Construction Hearing, to the extent the parties or the Court believe a hearing is necessary for construction of the claims at issue.

4-7. Good Faith Participation

A failure to make a good faith effort to narrow the instances of disputed terms or otherwise participate in the meet and confer process of any of the provisions of section 4 may expose counsel to sanctions, including under 28 U.S.C. § 1927.

LOCAL CIVIL AND CRIMINAL RULES
OF THE
UNITED STATES DISTRICT COURT
FOR THE
DISTRICT OF NEW JERSEY



With Revisions as of
April 3, 2014

L. Civ. R. 9.3 — LOCAL PATENT RULES

TABLE OF CONTENTS EXPLANATORY NOTES FOR 2011 AMENDMENTS

1. SCOPE OF RULES
 - 1.1. Title
 - 1.2. Scope and Construction
 - 1.3. Modification of these Rules
 - 1.4. Effective Date
 - 1.5. Patent Pilot Project
2. GENERAL PROVISIONS
 - 2.1. Governing Procedure
 - (a) Initial Scheduling Conference
 - 2.2. Confidentiality
 - 2.3. Relationship to Federal Rules of Civil Procedure
 - 2.4. Exchange of Expert Materials
3. PATENT DISCLOSURES
 - 3.1. Disclosure of Asserted Claims and Infringement Contentions
 - 3.2. Document Production Accompanying Disclosure
 - 3.2A. Non-Infringement Contentions and Responses
 - 3.3. Invalidity Contentions
 - 3.4. Document Production Accompanying Invalidity Contentions
 - 3.4A. Responses to Invalidity Contentions
 - 3.5. Disclosure Requirement in Patent Cases for Declaratory Judgment of Invalidity
 - (a) Invalidity Contentions If No Claim of Infringement
 - (b) Inapplicability of Rule
 - 3.6. Disclosure Requirements for Patent Cases Arising Under 21 U.S.C. § 355 (commonly referred to as “the Hatch-Waxman Act”)
 - 3.7. Amendments
 - 3.8. Advice of Counsel
4. CLAIM CONSTRUCTION PROCEEDINGS
 - 4.1. Exchange of Proposed Terms for Construction
 - 4.2. Exchange of Preliminary Claim Constructions and Extrinsic Evidence
 - 4.3. Joint Claim Construction and Prehearing Statement
 - 4.4. Completion of Claim Construction Discovery
 - 4.5. Claim Construction Submissions
 - 4.6. Claim Construction Hearing

UNITED STATES DISTRICT COURT
DISTRICT OF NEW JERSEY

REPORT OF THE LOCAL PATENT RULES COMMITTEE
Explanatory Notes for 2011 Amendments

In September 2010, almost two years after the Local Patent Rules had been adopted, the Committee reconvened to assess the impact and effectiveness of the Local Patent Rules. Based on the experiences of members of the Committee from the Judiciary and the Bar, there was an unanimous view that the Local Patent Rules have served to benefit the Court and the parties in patent litigation.

Notwithstanding those positive experiences, the Committee also believed that certain amendments might be warranted. Those areas of proposed changes include: (a) design patents; (b) certain disclosure obligations; (c) clarifying disclosure of evidence in connection with a *Markman* hearing; (d) need for responses to infringement and invalidity contentions; (e) specific modifications for disclosures exclusive to Hatch-Waxman cases; (f) amendments to required submissions or filings; and clarification in the language of rules.

Subcommittees were appointed for each of the subject areas and shortly thereafter recommendations were proposed to the full Committee, which discussed them at length.

With regard to design patents, shortly after the Committee had submitted its proposed patent rules in 2008, the Court of Appeals for the Federal Circuit issued its en banc ruling in *Egyptian Goddess v. Swisa*, 543 F.3d 665 (2008), which held, in part, that a trial court should not provide a detailed verbal description of the claimed design. This holding is in tension with certain of the Local Patent Rules which call for a narrative claims chart, claim construction contentions and a claim construction hearing. The Committee determined that in light of the Federal Circuit authority modifications were appropriate to better suit the needs of design patents. See L. Pat. R. 3.1(c) and (e); 3.3(c); 3.4A(c); 4.1(c); 4.2(e); 4.3(g); 4.4; and 4.5(d).

While the Local Patent Rules expressly reference obligations regarding infringement and invalidity, the Committee noted that in cases outside of Hatch-Waxman matters, no provision presently exists that requires the allegedly infringing party to provide its non-infringement contentions. Accordingly, the Committee proposed disclosure obligations for non-infringement similar to those required for assertion of infringement and invalidity. See L. Pat. R. 3.2A(a) and (b); and 3.4(c).

As to invalidity contentions, while there are disclosure obligations by a party asserting invalidity, the Committee determined that a requirement that mandates that the patent holder respond in kind to invalidity contentions will provide parity between the parties and serve to focus the invalidity challenge. See L. Pat. R. 3.4A(a),(b) and (c); and 3.5 (a).

To help ensure that the spirit of the disclosure obligations is fully appreciated, the Committee recommended various rules requiring parties to disclose all materials that they intend to rely upon in connection with infringement, non-infringement,

and invalidity contentions and or responses thereto. See L. Pat. R. 3.2(f); 3.2A(c); 3.4(c); and 3.4A(d).

In the area of Hatch-Waxman actions under L. Pat. R. 3.6, the Committee concluded that in order to help narrow the focus of a generic's invalidity contentions, the patent holder should be required to provide early disclosure of each patent and patent claim for infringement to which its infringement contentions would be limited. This eliminates speculation and added work by the generics in formulating their non-infringement and invalidity contentions. Changes recommended to disclosure obligations in non-Hatch-Waxman cases as they would apply in the Hatch-Waxman context were also proposed. In addition, the Committee determined that the ANDA filer should produce its Abbreviated New Drug Application or New Drug Application shortly after filing an answer or motion as this is a fundamental element of the Hatch-Waxman action. It was also recommended that the ANDA filer be required to advise the Food and Drug Administration ("FDA") of any motion for injunctive relief and supply the parties with relevant communications with the FDA which concern the subject matter filed in the District Court. This is intended to keep the FDA and parties apprised of any proceedings that may impact the ongoing litigation. See L. Pat. R. 3.6(a), (b), (c), (i) and (j).

In an effort to avoid potential misunderstandings as to the scope of permitted amendments to obligations under the Local Patent Rules, the Committee sought to clarify that amendments apply to all filings with the Court or exchanges between the parties as may be required by the Local Patent Rules. The proposed rule also makes plain that any amendments require the approval of the Court, notwithstanding consent by the parties. See L. Pat. R. 3.7.

Finally, as to claim construction and claim construction proceedings, the Committee proposed adding language to clarify that evidence to be used must be disclosed in a timely fashion. See L. Pat. R. 4.2(b) and (c); and 4.3(f).

In December 2010, the Committee submitted the proposed amendments to the Board of Judges for their consideration.

Appendix D: Patent Local Rules

Local Patent Rules Committee

Hon. Jerome B. Simandle, U.S.D.J., Chair
Hon. Stanley R. Chesler, U.S.D.J.
Hon. Mary L. Cooper, U.S.D.J.
Hon. Faith S. Hochberg, U.S.D.J.
Hon. Peter G. Sheridan, U.S.D.J.
Hon. Tonianne J. Bongiovanni, U.S.M.J.
Hon. Joel Schneider, U.S.M.J.
Hon. Mark Falk, U.S.M.J.
Hon. Patty Shwartz, U.S.M.J.
John T. O'Brien, Legal Coordinator
Arnold B. Calmann, Esq.
Thomas Curtin, Esq.
David De Lorenzi, Esq.
Marc S. Friedman, Esq.
Dennis F. Gleason, Esq.
Mary Sue Henifin, Esq.
Norman E. Lehrer, Esq.
Peter Menell, Prof. of Law, Univ. of Calif., Berkeley School of Law
William L. Mentlik, Esq.
George F. Pappas, Esq.
Matthew D. Powers, Esq.
Donald Robinson, Esq.
Robert G. Shepherd Esq.

December 2, 2010

1.1. Title.

L. Civ. R. 9.3 -- LOCAL PATENT RULES

1. SCOPE OF RULES These are the Local Patent Rules for the United States District Court for the District of New Jersey. They should be cited as “L. Pat. R. ____.”

1.2. Scope and Construction.

These rules apply to all civil actions filed in or transferred to this Court which allege infringement of a patent in a complaint, counterclaim, cross-claim or third party claim, or which seek a declaratory judgment that a patent is not infringed, is invalid or is unenforceable. The Local Civil Rules of this Court shall also apply to such actions, except to the extent that they are inconsistent with these Local Patent Rules. If the filings or actions in a case do not trigger the application of these Local Patent Rules under the terms set forth herein, the parties shall, as soon as such circumstances become known, meet and confer for the purpose of agreeing on the application of these Local Patent Rules to the case and promptly report the results of the meet and confer to the Court.

1.3. Modification of these Rules.

The Court may modify the obligations or deadlines set forth in these Local Patent Rules based on the circumstances of any particular case, including, without limitation, the simplicity or complexity of the case as shown by the patents, claims, products, or parties involved. Such modifications shall, in most cases, be made at the initial Scheduling Conference, but may be made at other times by the Court sua sponte or upon a showing of good cause. In advance of submission of any request for a modification, the parties shall meet and confer for purposes of reaching an agreement, if possible, upon any modification.

1.4. Effective Date.

These Local Patent Rules take effect on January 1, 2009. They govern patent cases filed, transferred or removed on or after that date. For actions pending prior to the effective date, the Court will confer with the parties and apply these rules as the Court deems practicable.

1.5. Patent Pilot Project.

Procedures for allocation and assignment of patent cases under the Patent Pilot Project pursuant to Pub. L. No. 111-349, § 1, are provided in L. Civ. R. 40.1(f) and Appendix T to the Local Civil Rules.

2. GENERAL PROVISIONS

2.1. Governing Procedure.

(a) **Initial Scheduling Conference.** When the parties confer pursuant to Fed. R. Civ. P. 26(f), the parties shall discuss and address in the Discovery Plan submitted pursuant to Fed. R. Civ. P. 26(f) and L. Civ. R. 26.1(b)(2) the topics set forth in those rules and the following topics:

- (1) Proposed modification of the obligations or deadlines set forth in these Local Patent Rules to ensure that they are suitable for the circumstances of the particular case (see L. Pat. R. 1.3);
- (2) The scope and timing of any claim construction discovery including disclosure of and discovery from any expert witness permitted by the court;
- (3) The format of the Claim Construction Hearing, including whether the Court will hear live testimony, the order of presentation, and the estimated length of the hearing;
- (4) How the parties intend to educate the Court on the patent(s) at issue; and
- (5) The need for any discovery confidentiality order and a schedule for presenting certification(s) required by L. Civ. R. 5.3(b)(2).

2.2. Confidentiality.

Discovery cannot be withheld or delayed on the basis of confidentiality absent Court order. Pending entry of a discovery confidentiality order, discovery and disclosures deemed confidential by a party shall be produced to the adverse party for outside counsel's Attorney's Eyes Only, solely for purposes of the pending case and shall not be disclosed to the client or any other person.

Within 30 days after the initial Scheduling Conference, (a) the parties shall present a consent discovery confidentiality order, supported by a sufficient certification (or statement complying with 28 U.S.C. § 1746) under L. Civ. R. 5.3(b)(2), or (b) in the absence of consent, a party shall, supported by a sufficient certification, apply for entry of a discovery confidentiality order under L. Civ. R. 5.3(b)(5) and L. Civ. R. 37.1(a)(1). The Court will decide those issues and enter the appropriate order, or the Court may enter the District's approved Discovery Confidentiality Order as set forth in Appendix S to these Rules if appropriate, in whole or in part.

With respect to all issues of discovery confidentiality, the parties shall comply with all terms of L. Civ. R. 5.3.

2.3. Relationship to Federal Rules of Civil Procedure.

Except as provided in this paragraph or as otherwise ordered, it shall not be a ground for objecting to an opposing party's discovery request (e.g., interrogatory, document request, request for admission, deposition question) or declining to provide information otherwise required to be disclosed pursuant to Fed. R. Civ. P.

26(a)(1) that the discovery request or disclosure requirement is premature in light of, or otherwise conflicts with, these Local Patent Rules, absent other legitimate objection. A party may object, however, to responding to the following categories of discovery requests (or decline to provide information in its initial disclosures under Fed. R. Civ. P. 26(a)(1)) on the ground that they are premature in light of the timetable provided in the Local Patent Rules:

- (a) Requests seeking to elicit a party's claim construction position;
- (b) Requests seeking to elicit a comparison of the asserted claims and the accused apparatus, product, device, process, method, act, or other instrumentality;
- (c) Requests seeking to elicit a comparison of the asserted claims and the prior art; and
- (d) Requests seeking to elicit the identification of any advice of counsel, and related documents.

Where a party properly objects to a discovery request (or declines to provide information in its initial disclosures under Fed. R. Civ. P. 26(a)(1)) as set forth above, that party shall provide the requested information on the date on which it is required to be provided to an opposing party under these Local Patent Rules or as set by the Court, unless there exists another legitimate ground for objection.

2.4. Exchange of Expert Materials.

(a) Disclosures of claim construction expert materials and depositions of such experts are governed by L. Pat. R. 4.1, et seq., unless otherwise ordered by the Court.

(b) Upon a sufficient showing that expert reports related to issues other than claim construction cannot be rendered until after a claim construction ruling has been entered by the Court, the disclosure of expert materials related to issues other than claim construction will not be required until claim construction issues have been decided.

3. PATENT DISCLOSURES

3.1. Disclosure of Asserted Claims and Infringement Contentions.

Not later than 14 days after the initial Scheduling Conference, a party asserting patent infringement shall serve on all parties a "Disclosure of Asserted Claims and Infringement Contentions." Separately for each opposing party, the "Disclosure of Asserted Claims and Infringement Contentions" shall contain the following information:

(a) Each claim of each patent in suit that is allegedly infringed by each opposing party, including for each claim the applicable statutory subsections of 35 U.S.C. § 271 asserted;

(b) Separately for each asserted claim, each accused apparatus, product, device, process, method, act, or other instrumentality ("Accused Instrumentality") of each opposing party of which the party is aware. This identification shall be as specific as possible. Each product, device, and apparatus shall be identified by name or model

Appendix D: Patent Local Rules

number, if known. Each method or process shall be identified by name, if known, or by any product, device, or apparatus which, when used, allegedly results in the practice of the claimed method or process;

(c) Other than for design patents, a chart identifying specifically where each limitation of each asserted claim is found within each Accused Instrumentality, including for each limitation that such party contends is governed by 35 U.S.C. § 112(6), the identity of the structure(s), act(s), or material(s) in the Accused Instrumentality that performs the claimed function;

(d) For each claim which is alleged to have been indirectly infringed, an identification of any direct infringement and a description of the acts of the alleged indirect infringer that contribute to or are inducing that direct infringement. Insofar as alleged direct infringement is based on joint acts of multiple parties, the role of each such party in the direct infringement must be described;

(e) Other than for design patents, whether each limitation of each asserted claim is alleged to be literally present or present under the doctrine of equivalents in the Accused Instrumentality;

(f) For any patent that claims priority to an earlier application, the priority date to which each asserted claim allegedly is entitled;

(g) If a party asserting patent infringement wishes to preserve the right to rely, for any purpose, on the assertion that its own apparatus, product, device, process, method, act, or other instrumentality practices the claimed invention, the party shall identify, separately for each asserted claim, each such apparatus, product, device, process, method, act, or other instrumentality that incorporates or reflects that particular claim; and

(h) If a party asserting patent infringement alleges willful infringement, the basis for such allegation.

3.2. Document Production Accompanying Disclosure.

With the “Disclosure of Asserted Claims and Infringement Contentions,” the party asserting patent infringement shall produce to each opposing party or make available for inspection and copying:

(a) Documents (e.g., contracts, purchase orders, invoices, advertisements, marketing materials, offer letters, beta site testing agreements, and third party or joint development agreements) sufficient to evidence each discussion with, disclosure to, or other manner of providing to a third party, or sale of or offer to sell, or any public use of, the claimed invention prior to the date of application for the patent in suit. A party's production of a document as required herein shall not constitute an admission that such document evidences or is prior art under 35 U.S.C. § 102;

(b) All documents evidencing the conception, reduction to practice, design, and development of each claimed invention, which were created on or before the date of application for the patent in suit or the priority date identified pursuant to L. Pat. R. 3.1(f), whichever is earlier;

(c) A copy of the file history for each patent in suit (or so much thereof as is in the possession of the party asserting patent infringement);

(d) All documents evidencing ownership of the patent rights by the party asserting patent infringement;

(e) If a party identifies instrumentalities pursuant to L. Pat. R. 3.1(g), documents sufficient to show the operation of any aspects or elements of such instrumentalities the party asserting patent infringement relies upon as embodying any asserted claims; and

(f) All documents or things that a party asserting patent infringement intends to rely on in support of any of its infringement contentions under these Rules.

(g) With respect to each of the above document productions, the producing party shall separately identify by production number which documents correspond to each category.

3.2A. Non-Infringement Contentions and Responses.

Not later than 45 days after service upon it of the “Disclosure of Asserted Claims and Infringement Contentions,” each party opposing an assertion of patent infringement shall serve on all parties its “Non-infringement Contentions and Responses” to Infringement Contentions which shall include the following:

(a) The written basis for its Non-Infringement Contentions and responses;

(b) The party's responses shall follow the order of the infringement claims chart that is required under L. Pat. R. 3.1(c), and shall set forth the party's agreement or disagreement with each allegation therein, including any additional or different claims at issue;

(c) The production or the making available for inspection of any document or thing that it intends to rely on in defense against any such Infringement Contentions.

3.3. Invalidity Contentions.

Not later than 45 days after service upon it of the “Disclosure of Asserted Claims and Infringement Contentions,” each party opposing an assertion of patent infringement, shall serve on all parties its “Invalidity Contentions” which shall contain the following information:

(a) The identity of each item of prior art that allegedly anticipates each asserted claim or renders it obvious. Each prior art patent shall be identified by its number, country of origin, and date of issue. Each prior art publication shall be identified by its title, date of publication, and where feasible, author and publisher. Prior art under 35 U.S.C. § 102(b) shall be identified by specifying the item offered for sale or publicly used or known, the date the offer or use took place or the information became known, and the identity of the person or entity which made the use or which made and received the offer, or the person or entity which made the information known or to whom it was made known. Prior art under 35 U.S.C. § 102(f) shall be identified by providing the name of the person(s) from whom and the circumstances under which the invention or any part of it was derived. Prior art under 35 U.S.C. § 102(g) shall be identified by providing the identities of the person(s) or entities

involved in and the circumstances surrounding the making of the invention before the patent applicant(s);

(b) Whether each item of prior art anticipates each asserted claim or renders it obvious. If obviousness is alleged, an explanation of why the prior art renders the asserted claim obvious, including an identification of any combinations of prior art showing obviousness;

(c) Other than for design patents, a chart identifying where specifically in each alleged item of prior art each limitation of each asserted claim is found, including for each limitation that such party contends is governed by 35 U.S.C. § 112(6), the identity of the structure(s), act(s), or material(s) in each item of prior art that performs the claimed function; and

(d) Any grounds of invalidity based on 35 U.S.C. § 101, indefiniteness under 35 U.S.C. § 112(2) or enablement or written description under 35 U.S.C. § 112(1) of any of the asserted claims.

3.4. Document Production Accompanying Invalidity Contentions.

With the “Invalidity Contentions,” the party opposing an assertion of patent infringement shall produce or make available for inspection and copying:

(a) Source code, specifications, schematics, flow charts, artwork, formulas, or other documentation sufficient to show the operation, composition, or structure of any aspects or elements of an Accused Instrumentality identified by the party asserting patent infringement in its L. Pat. R. 3.1(c) chart; and

(b) A copy or sample of the prior art identified pursuant to L. Pat. R. 3.3(a) which does not appear in the file history of the patent(s) at issue. To the extent any such item is not in English, an English translation of the portion(s) relied upon shall be produced.

(c) A party asserting invalidity shall also produce any other document or thing on which it intends to rely in support of its assertion.

(d) With respect to each of the above document productions, the producing party shall separately identify by production number which documents correspond to each category.

3.4A. Responses to Invalidity Contentions.

Not later than 14 days after service upon it of the “Invalidity Contentions,” each party defending the validity of the patent shall serve on all parties its “Responses to Invalidity Contentions” which shall include the following:

(a) For each item of asserted prior art, the identification of each limitation of each asserted claim that the party believes is absent from the prior art, except for design patents, where the party shall supply an explanation why the prior art does not anticipate the claim;

(b) If obviousness is alleged, an explanation of why the prior art does not render the asserted claim obvious;

(c) The party's responses shall follow the order of the invalidity chart required under L. Pat. R. 3.3(c), and shall set forth the party's agreement or disagreement with each allegation therein and the written basis thereof; and

(d) The production or the making available for inspection and copying of any document or thing that the party intends to rely on in support of its Responses herein.

3.5. Disclosure Requirement in Patent Cases for Declaratory Judgment of Invalidity.

(a) **Invalidity Contentions If No Claim of Infringement.** In all cases in which a party files a complaint or other pleading seeking a declaratory judgment that a patent is invalid, L. Pat. R. 3.1 and 3.2 shall not apply unless and until a claim for patent infringement is made by a party. If the declaratory defendant does not assert a claim for patent infringement in its answer to the complaint, or within 14 days after the Initial Scheduling Conference, whichever is later, the party seeking a declaratory judgment of invalidity shall serve upon each opposing party its Invalidity Contentions that conform to L. Pat. R. 3.3 and produce or make available for inspection and copying the documents described in L. Pat. R. 3.4. Each party opposing the declaratory plaintiff's complaint seeking a declaratory judgment of invalidity shall serve its "Responses to Invalidity Contentions" as required under L. Pat. R. 3.4A.

(b) **Inapplicability of Rule.** This L. Pat. R. 3.5 shall not apply to cases in which a request for a declaratory judgment that a patent is invalid is filed in response to a complaint for infringement of the same patent, in which case the provisions of L. Pat. R. 3.3 and 3.4 shall govern.

3.6. Disclosure Requirements for Patent Cases Arising Under 21 U.S.C. § 355 (commonly referred to as "the Hatch-Waxman Act").

The following applies to all patents subject to a Paragraph IV certification in cases arising under 21 U.S.C. § 355 (commonly referred to as "the Hatch-Waxman Act"). This rule takes precedence over any conflicting provisions in L. Pat. R. 3.1 to 3.5 for all cases arising under 21 U.S.C. § 355.

(a) On the date a party answers, moves, or otherwise responds, each party who is an ANDA filer shall produce to each party asserting patent infringement the entire Abbreviated New Drug Application or New Drug Application that is the basis of the case in question.

(b) Not more than seven days after the initial Scheduling Conference, each party asserting patent infringement shall serve on all parties a "Disclosure of Asserted Claims" that lists each claim of each patent that is allegedly infringed by each opposing party, including for each claim the applicable statutory subsections of 35 U.S.C. § 271 asserted.

(c) Not more than 14 days after the initial Scheduling Conference, each party opposing an assertion of patent infringement shall provide to each party asserting

Appendix D: Patent Local Rules

patent infringement the written basis for its “Invalidity Contentions,” for any patents referred to in the opposing party’s Paragraph IV Certification, which shall contain all disclosures required by L. Pat. R. 3.3.

(d) Any “Invalidity Contentions” disclosed under L. Pat. R. 3.6(c), shall be accompanied by the production of documents required under L. Pat. R. 3.4(b) and (c).

(e) Not more than 14 days after the initial Scheduling Conference, each party opposing an assertion of patent infringement shall provide to each party asserting patent infringement the written basis for its “Non-Infringement Contentions,” for any patents referred to in the opposing party’s Paragraph IV Certification which shall include a claim chart identifying each claim at issue in the case and each limitation of each claim at issue. The claim chart shall specifically identify for each claim which claim limitation(s) is/(are) literally absent from each opposing party’s allegedly infringing Abbreviated New Drug Application or New Drug Application.

(f) Any “Non-Infringement Contentions” disclosed under L. Pat. R. 3.6(e), shall be accompanied by the production of any document or thing that each party who is an ANDA filer intends to rely on in defense against any infringement contentions by each party asserting patent infringement.

(g) Not more than 45 days after the disclosure of the “Non-Infringement Contentions” as required by L. Pat. R. 3.6(e), each party asserting patent infringement shall provide each opposing party with a “Disclosure of Infringement Contentions,” for all patents referred to in each opposing party’s Paragraph IV Certification, which shall contain all disclosures required by L. Pat. R. 3.1. The infringement contentions shall be limited to the claims identified in L. Pat. R. 3.6(b).

(h) Any “Disclosure of Asserted Claims and Infringement Contentions” disclosed under L. Pat. R. 3.6(g), shall be accompanied by the production of documents required under L. Pat. R. 3.2.

(i) Not more than 45 days after the disclosure of “Invalidity Contentions” as required by L. Pat. R. 3.6(c), the party defending the validity of the patent shall serve on each other party its “Responses to Invalidity Contentions” as required under L. Pat. R. 3.4A.

(j) Each party that has an ANDA application pending with the Food and Drug Administration (“FDA”) that is the basis of the pending case shall: (1) notify the FDA of any and all motions for injunctive relief no later than three business days after the date on which such a motion is filed; and (2) provide a copy of all correspondence between itself and the FDA pertaining to the ANDA application to each party asserting infringement, or set forth the basis of any claim of privilege for such correspondence pursuant to L. Civ. R. 34.1, no later than seven days after the date it sends same to the FDA or receives same from the FDA.

3.7. Amendments.

Amendment of any contentions, disclosures, or other documents required to be filed or exchanged pursuant to these Local Patent Rules may be made only by order of the Court upon a timely application and showing of good cause. The application shall disclose whether parties consent or object. Non-exhaustive examples of cir-

cumstances that may, absent undue prejudice to the adverse party, support a finding of good cause include: (a) a claim construction by the Court different from that proposed by the party seeking amendment; (b) recent discovery of material prior art despite earlier diligent search; (c) recent discovery of nonpublic information about the Accused Instrumentality which was not discovered, despite diligent efforts, before the service of the Infringement Contentions; (d) disclosure of an infringement contention by a Hatch- Waxman Act party asserting infringement under L. Pat. R. 3.6(g) that requires response by the adverse party because it was not previously presented or reasonably anticipated; and (e) consent by the parties in interest to the amendment and a showing that it will not lead to an enlargement of time or impact other scheduled deadlines. The duty to supplement discovery responses under Fed. R. Civ. P. 26(e) does not excuse the need to obtain leave of Court to amend contentions, disclosures, or other documents required to be filed or exchanged pursuant to these Local Patent Rules.

3.8. Advice of Counsel.

Unless otherwise ordered by the Court, not later than 30 days after entry of the Court's claim construction order, or upon such other date as set by the Court, each party relying upon advice of counsel as part of a patent-related claim or defense for any reason shall:

(a) Produce or make available for inspection and copying any written advice and documents related thereto for which the attorney-client and work product protection have been waived;

(b) Provide a written summary of any oral advice and produce or make available for inspection and copying that summary and documents related thereto for which the attorney-client and work product protection have been waived; and

(c) Serve a privilege log identifying any documents other than those identified in subpart (a) above, except those authored by counsel acting solely as trial counsel, relating to the subject matter of the advice which the party is withholding on the grounds of attorney-client privilege or work product protection.

A party who does not comply with the requirements of this L. Pat. R. 3.8 shall not be permitted to rely on advice of counsel for any purpose absent a stipulation of all parties or by order of the Court.

4. CLAIM CONSTRUCTION PROCEEDINGS

4.1. Exchange of Proposed Terms for Construction.

(a) Not later than 14 days after service of the "Responses to Invalidity Contentions" pursuant to L. Pat. R. 3.4A, not later than 45 days after service upon it of the "Non-Infringement Contentions and Responses" pursuant to L. Pat. R. 3.2A in those actions where validity is not at issue (and L. Pat. R. 3.3 does not apply), or, in all cases in which a party files a complaint or other pleading seeking a declaratory judgment not based on validity, not later than 14 days after the defendant serves an an-

Appendix D: Patent Local Rules

swer that does not assert a claim for patent infringement (and L. Pat. R. 3.1 does not apply), each party shall serve on each other party a list of claim terms which that party contends should be construed by the Court, and identify any claim term which that party contends should be governed by 35 U.S.C. § 112(6).

(b) The parties shall thereafter meet and confer for the purposes of limiting the terms in dispute by narrowing or resolving differences and facilitating the ultimate preparation of a Joint Claim Construction and Prehearing Statement.

(c) This rule does not apply to design patents.

4.2. Exchange of Preliminary Claim Constructions and Extrinsic Evidence.

(a) Not later than 21 days after the exchange of the lists pursuant to L. Pat. R. 4.1, the parties shall simultaneously exchange preliminary proposed constructions of each term identified by any party for claim construction. Each such “Preliminary Claim Construction” shall also, for each term which any party contends is governed by 35 U.S.C. § 112(6), identify the structure(s), act(s), or material(s) corresponding to that term's function.

(b) At the same time the parties exchange their respective “Preliminary Claim Constructions,” each party shall also identify all intrinsic evidence, all references from the specification or prosecution history that support its preliminary proposed construction and designate any supporting extrinsic evidence including, without limitation, dictionary definitions, citations to learned treatises and prior art and testimony of all witnesses including expert witnesses. Extrinsic evidence shall be identified by production number or by producing a copy if not previously produced. With respect to all witnesses including experts, the identifying party shall also provide a description of the substance of that witness' proposed testimony that includes a listing of any opinions to be rendered in connection with claim construction.

(c) Not later than 14 days after the parties exchange the “Preliminary Claim Constructions” under this rule, the parties shall exchange an identification of all intrinsic evidence and extrinsic evidence that each party intends to rely upon to oppose any other party's proposed construction, including without limitation, the evidence referenced in L. Pat. R. 4.2(b).

(d) The parties shall thereafter meet and confer for the purposes of narrowing the issues and finalizing preparation of a Joint Claim Construction and Prehearing Statement.

(e) This rule does not apply to design patents.

4.3. Joint Claim Construction and Prehearing Statement.

Not later than 30 days after the exchange of “Preliminary Claim Constructions” under L. Pat. R. 4.2(a), the parties shall complete and file a Joint Claim Construction and Prehearing Statement, which shall contain the following information:

(a) The construction of those terms on which the parties agree;

(b) Each party's proposed construction of each disputed term, together with an identification of all references from the intrinsic evidence that support that construc-

tion, and an identification of any extrinsic evidence known to the party on which it intends to rely either to support its proposed construction or to oppose any other party's proposed construction, including, but not limited to, as permitted by law, dictionary definitions, citations to learned treatises and prior art, and testimony of all witnesses including experts;

(c) An identification of the terms whose construction will be most significant to the resolution of the case. The parties shall also identify any term whose construction will be case or claim dispositive or substantially conducive to promoting settlement, and the reasons therefor;

(d) The anticipated length of time necessary for the Claim Construction Hearing; and (e) Whether any party proposes to call one or more witnesses at the Claim Construction Hearing, the identity of each such witness, and for each witness, a summary of his or her testimony including, for any expert, each opinion to be offered related to claim construction.

(f) Any evidence that is not identified under L. Pat. R. 4.2(a) through 4.2(c) inclusive shall not be included in the Joint Claim Construction and Prehearing Statement.

(g) This rule does not apply to design patents.

4.4. Completion of Claim Construction Discovery.

Not later than 30 days after service and filing of the Joint Claim Construction and Prehearing Statement, the parties shall complete all discovery relating to claim construction, including any depositions with respect to claim construction of any witnesses, other than experts, identified in the Preliminary Claim Construction statement (L. Pat. R. 4.2) or Joint Claim Construction and Prehearing Statement (L. Pat. R. 4.3). This rule does not apply to design patents.

4.5. Claim Construction Submissions.

(a) Not later than 45 days after serving and filing the Joint Claim Construction and Prehearing Statement, the parties shall contemporaneously file and serve their opening Markman briefs and any evidence supporting claim construction, including experts' certifications or declarations ("Opening Markman Submissions").

(b) Unless otherwise ordered by the Court, any discovery from an expert witness who submitted a certification or declaration under L. Pat. R. 4.5(a) shall be concluded within 30 days after filing the Opening Markman Submissions.

(c) Not later than 60 days after the filing of the Opening Markman Submissions, the parties shall contemporaneously file and serve responding Markman briefs and any evidence supporting claim construction, including any responding experts' certifications or declarations.

(d) With regard to design patents only, subsections (a), (b), and (c) shall not apply. Where a design patent is at issue, not later than 45 days after the submission of "Non- Infringement Contentions and Responses" under L. Pat. R. 3.2A and/or "Responses to Invalidity Contentions" under L. Pat. R. 3.4A, the parties shall contempo-

Appendix D: Patent Local Rules

aneously file and serve opening Markman briefs and any evidence supporting claim construction. Not more than 30 days after the filing of the opening Markman briefs, the parties shall contemporaneously file and serve responding Markman briefs and any evidence supporting claim construction.

4.6. Claim Construction Hearing.

Within two weeks following submission of the briefs and evidence specified in L. Pat. R. 4.5(c) and (d), counsel shall confer and propose to the Court a schedule for a Claim Construction Hearing, to the extent the parties or the Court believe a hearing is necessary for construction of the claims at issue.

Adopted December 11, 2008, Effective January 1, 2009, Amended March 18, 2011, October 4, 2011, June 9, 2013.

- Current as of May 6, 2015
(General Order 15-12)

APPENDIX B PATENT RULES

1. SCOPE OF RULES

1-1. Title.

These are the Rules of Practice for Patent Cases before the Eastern District of Texas. They should be cited as “P. R. ___.”

1-2. Scope and Construction.

These rules apply to all civil actions filed in or transferred to this Court which allege infringement of a utility patent in a complaint, counterclaim, cross-claim or third party claim, or which seek a declaratory judgment that a utility patent is not infringed, is invalid or is unenforceable. The Court may accelerate, extend, eliminate, or modify the obligations or deadlines set forth in these Patent Rules based on the circumstances of any particular case, including, without limitation, the complexity of the case or the number of patents, claims, products, or parties involved. If any motion filed prior to the Claim Construction Hearing provided for in P. R. 4-6 raises claim construction issues, the Court may, for good cause shown, defer the motion until after completion of the disclosures, filings, or ruling following the Claim Construction Hearing. The Civil Local Rules of this Court shall also apply to these actions, except to the extent that they are inconsistent with these Patent Rules. The deadlines set forth in these rules may be modified by Docket Control Order issued in specific cases.

1-3. Effective Date.

These Patent Rules shall take effect on February 22, 2005 and shall apply to any case filed thereafter and to any pending case in which more than 9 days remain before the Initial Disclosure of Asserted Claims is made. The parties to any other pending civil action shall meet and confer promptly after February 22, 2005, for the purpose of determining whether any provision in these Patent Rules should be made applicable to that case. No later than 7 days after the parties meet and confer, the parties shall file a stipulation setting forth a proposed order that relates to the application of these Patent Rules. Unless and until an order is entered applying these Patent Local Rules to any pending case, the Rules previously applicable to pending patent cases shall govern.

2. GENERAL PROVISIONS

2-1. Governing Procedure.

(a) **Initial Case Management Conference.** Prior to the Initial Case Management Conference with the Court, when the parties confer with each other pursuant to Fed. R. Civ. P. 26(f), in addition to the matters covered by Fed. R. Civ. P. 26, the parties must discuss and address in the Case Management Statement filed pursuant to Fed. R. Civ. P. 26(f), the following topics:

- (1) Proposed modification of the deadlines provided for in the Patent Rules, and the effect of any such modification on the date and time of the Claim Construction Hearing, if any;
- (2) Whether the Court will hear live testimony at the Claim Construction Hearing;
- (3) The need for and any specific limits on discovery relating to claim construction, including depositions of witnesses, including expert witnesses;
- (4) The order of presentation at the Claim Construction Hearing; and
- (5) The scheduling of a Claim Construction Prehearing Conference to be held after the Joint Claim Construction and Prehearing Statement provided for in P. R. 4-3 has been filed.
- (6) Whether the court should authorize the filing under seal of any documents containing confidential information.

(b) **Further Case Management Conferences.** To the extent that some or all of the matters provided for in P. R. 2-1 (a)(1)-(5) are not resolved or decided at the Initial Case Management Conference, the parties shall propose dates for further Case Management Conferences at which such matters shall be decided.

(c) **Electronic Filings.** All patents attached as exhibits to any filing submitted electronically shall be in searchable PDF format. Any other documents attached as exhibits to any filing submitted electronically should be in searchable PDF format whenever possible.

2-2. Confidentiality.

If any document or information produced under these Patent Local Rules is deemed confidential by the producing party and if the Court has not entered a protective order, until a protective order is issued by the Court, the document shall be

marked "confidential" or with some other confidential designation (such as "Confidential B Outside Attorneys Eyes Only") by the disclosing party and disclosure of the confidential document or information shall be limited to each party's outside attorney(s) of record and the employees of such outside attorney(s).

If a party is not represented by an outside attorney, disclosure of the confidential document or information shall be limited to one designated "in house" attorney, whose identity and job functions shall be disclosed to the producing party 5 days prior to any such disclosure, in order to permit any motion for protective order or other relief regarding such disclosure. The person(s) to whom disclosure of a confidential document or information is made under this local rule shall keep it confidential and use it only for purposes of litigating the case.

2-3. Certification of Initial Disclosures.

All statements, disclosures, or charts filed or served in accordance with these Patent Rules must be dated and signed by counsel of record. Counsel's signature shall constitute a certification that to the best of his or her knowledge, information, and belief, formed after an inquiry that is reasonable under the circumstances, the information contained in the statement, disclosure, or chart is complete and correct at the time it is made.

2-4. Admissibility of Disclosures.

Statements, disclosures, or charts governed by these Patent Rules are admissible to the extent permitted by the Federal Rules of Evidence or Procedure. However, the statements or disclosures provided for in P. R. 4-1 and 4-2 are not admissible for any purpose other than in connection with motions seeking an extension or modification of the time periods within which actions contemplated by these Patent Rules must be taken.

2-5. Relationship to Federal Rules of Civil Procedure.

Except as provided in this paragraph or as otherwise ordered, it shall not be a legitimate ground for objecting to an opposing party's discovery request (e.g., interrogatory, document request, request for admission, deposition question) or declining to provide information otherwise required to be disclosed pursuant to Fed. R. Civ. P. 26(a)(1) that the discovery request or disclosure requirement is premature in light of, or otherwise conflicts with, these Patent Rules. A party may object, however, to responding to the following categories of discovery requests (or decline to provide information in its initial disclosures under Fed. R. Civ. P. 26(a)(1)) on the ground that they are premature in light of the timetable provided in the Patent Rules:

- (a) Requests seeking to elicit a party's claim construction position;

(b) Requests seeking to elicit from the patent claimant a comparison of the asserted claims and the accused apparatus, product, device, process, method, act, or other instrumentality;

(c) Requests seeking to elicit from an accused infringer a comparison of the asserted claims and the prior art; and

(d) Requests seeking to elicit from an accused infringer the identification of any opinions of counsel, and related documents, that it intends to rely upon as a defense to an allegation of willful infringement.

Where a party properly objects to a discovery request (or declines to provide information in its initial disclosures under Fed. R. Civ. P. 26(a)(1)) as set forth above, that party shall provide the requested information on the date on which it is required to provide the requested information to an opposing party under these Patent Rules, unless there exists another legitimate ground for objection.

2-6. Assignment of Related Cases. Separately filed cases related to the same patent shall be assigned to the same judge, i.e., the judge assigned to the first related case.

3. PATENT INITIAL DISCLOSURES

3-1. Disclosure of Asserted Claims and Infringement Contentions.

Not later than 10 days before the Initial Case Management Conference with the Court, a party claiming patent infringement must serve on all parties a “Disclosure of Asserted Claims and Infringement Contentions.” Separately for each opposing party, the “Disclosure of Asserted Claims and Infringement Contentions” shall contain the following information:

(a) Each claim of each patent in suit that is allegedly infringed by each opposing party;

(b) Separately for each asserted claim, each accused apparatus, product, device, process, method, act, or other instrumentality (“Accused Instrumentality”) of each opposing party of which the party is aware. This identification shall be as specific as possible. Each product, device, and apparatus must be identified by name or model number, if known. Each method or process must be identified by name, if known, or by any product, device, or apparatus which, when used, allegedly results in the practice of the claimed method or process;

(c) A chart identifying specifically where each element of each asserted claim is found within each Accused Instrumentality, including for each element that such

party contends is governed by 35 U.S.C. § 112(6), the identity of the structure(s), act(s), or material(s) in the Accused Instrumentality that performs the claimed function;

(d) Whether each element of each asserted claim is claimed to be literally present or present under the doctrine of equivalents in the Accused Instrumentality;

(e) For any patent that claims priority to an earlier application, the priority date to which each asserted claim allegedly is entitled; and

(f) If a party claiming patent infringement wishes to preserve the right to rely, for any purpose, on the assertion that its own apparatus, product, device, process, method, act, or other instrumentality practices the claimed invention, the party must identify, separately for each asserted claim, each such apparatus, product, device, process, method, act, or other instrumentality that incorporates or reflects that particular claim.

3-2. Document Production Accompanying Disclosure.

With the “Disclosure of Asserted Claims and Infringement Contentions,” the party claiming patent infringement must produce to each opposing party or make available for inspection and copying:

(a) Documents (e.g., contracts, purchase orders, invoices, advertisements, marketing materials, offer letters, beta site testing agreements, and third party or joint development agreements) sufficient to evidence each discussion with, disclosure to, or other manner of providing to a third party, or sale of or offer to sell, the claimed invention prior to the date of application for the patent in suit. A party’s production of a document as required herein shall not constitute an admission that such document evidences or is prior art under 35 U.S.C. § 102;

(b) All documents evidencing the conception, reduction to practice, design, and development of each claimed invention, which were created on or before the date of application for the patent in suit or the priority date identified pursuant to P. R. 3-1(e), whichever is earlier; and

(c) A copy of the file history for each patent in suit.

The producing party shall separately identify by production number which documents correspond to each category.

3-3. Invalidity Contentions.

Not later than 45 days after service upon it of the “Disclosure of Asserted Claims and Infringement Contentions,” each party opposing a claim of patent infringe-

ment, shall serve on all parties its “Invalidity Contentions“ which must contain the following information:

(a) The identity of each item of prior art that allegedly anticipates each asserted claim or renders it obvious. Each prior art patent shall be identified by its number, country of origin, and date of issue. Each prior art publication must be identified by its title, date of publication, and where feasible, author and publisher. Prior art under 35 U.S.C. § 102(b) shall be identified by specifying the item offered for sale or publicly used or known, the date the offer or use took place or the information became known, and the identity of the person or entity which made the use or which made and received the offer, or the person or entity which made the information known or to whom it was made known. Prior art under 35 U.S.C. § 102(f) shall be identified by providing the name of the person(s) from whom and the circumstances under which the invention or any part of it was derived. Prior art under 35 U.S.C. § 102(g) shall be identified by providing the identities of the person(s) or entities involved in and the circumstances surrounding the making of the invention before the patent applicant(s);

(b) Whether each item of prior art anticipates each asserted claim or renders it obvious. If a combination of items of prior art makes a claim obvious, each such combination, and the motivation to combine such items, must be identified;

(c) A chart identifying where specifically in each alleged item of prior art each element of each asserted claim is found, including for each element that such party contends is governed by 35 U.S.C. § 112(6), the identity of the structure(s), act(s), or material(s) in each item of prior art that performs the claimed function; and

(d) Any grounds of invalidity based on indefiniteness under 35 U.S.C. § 112(2) or enablement or written description under 35 U.S.C. § 112(1) of any of the asserted claims.

3-4. Document Production Accompanying Invalidity Contentions.

With the “Invalidity Contentions,“ the party opposing a claim of patent infringement must produce or make available for inspection and copying:

(a) Source code, specifications, schematics, flow charts, artwork, formulas, or other documentation sufficient to show the operation of any aspects or elements of an Accused Instrumentality identified by the patent claimant in its P. R. 3-1(c) chart; and

(b) A copy of each item of prior art identified pursuant to P. R. 3-3(a) which does not appear in the file history of the patent(s) at issue. To the extent any such item is not in English, an English translation of the portion(s) relied upon must be produced.

3-5. Disclosure Requirement in Patent Cases for Declaratory Judgment.

(a) Invalidity Contentions If No Claim of Infringement. In all cases in which a party files a complaint or other pleading seeking a declaratory judgment that a patent is not infringed, is invalid, or is unenforceable, P. R. 3-1 and 3-2 shall not apply unless and until a claim for patent infringement is made by a party. If the defendant does not assert a claim for patent infringement in its answer to the complaint, no later than 10 days after the defendant serves its answer, or 10 days after the Initial Case Management Conference, whichever is later, the party seeking a declaratory judgment must serve upon each opposing party its Invalidity Contentions that conform to P. R. 3-3 and produce or make available for inspection and copying the documents described in P. R. 3-4. The parties shall meet and confer within 10 days of the service of the Invalidity Contentions for the purpose of determining the date on which the plaintiff will file its Final Invalidity Contentions which shall be no later than 50 days after service by the Court of its Claim Construction Ruling.

(b) Applications of Rules When No Specified Triggering Event. If the filings or actions in a case do not trigger the application of these Patent Rules under the terms set forth herein, the parties shall, as soon as such circumstances become known, meet and confer for the purpose of agreeing on the application of these Patent Rules to the case.

(c) Inapplicability of Rule. This P. R. 3-5 shall not apply to cases in which a request for a declaratory judgment that a patent is not infringed, is invalid, or is unenforceable is filed in response to a complaint for infringement of the same patent.

3-6. Amending Contentions.

(a) Leave not required. Each party's "Infringement Contentions" and "Invalidity Contentions" shall be deemed to be that party's final contentions, except as set forth below.

(1) If a party claiming patent infringement believes in good faith that the Court's Claim Construction Ruling so requires, not later than 30 days after service by the Court of its Claim Construction Ruling, that party may serve "Amended Infringement Contentions" without leave of court that amend its "Infringement Contentions" with respect to the information required by Patent R. 3-1(c) and (d).

(2) Not later than 50 days after service by the Court of its Claim Construction Ruling, each party opposing a claim of patent infringement may serve "Amended Invalidity Contentions" without leave of court that amend its "Invalidity Contentions" with respect to the information required by P. R. 3-3 if:

Appendix D: Patent Local Rules

(A) a party claiming patent infringement has served “Infringement Contentions” pursuant to P. R. 3-6(a), or

(B) the party opposing a claim of patent infringement believes in good faith that the Court’s Claim Construction Ruling so requires.

(b) Leave required. Amendment or supplementation any Infringement Contentions or Invalidity Contentions, other than as expressly permitted in P. R. 3-6(a), may be made only by order of the Court, which shall be entered only upon a showing of good cause.

3-7 Opinion of Counsel Defenses.

By the date set forth in the Docket Control Order, each party opposing a claim of patent infringement that will rely on an opinion of counsel as part of a defense shall:

(a) Produce or make available for inspection and copying the opinion(s) and any other documents relating to the opinion(s) as to which that party agrees the attorney-client or work product protection has been waived; and

(b) Serve a privilege log identifying any other documents, except those authored by counsel acting solely as trial counsel, relating to the subject matter of the opinion(s) which the party is withholding on the grounds of attorney-client privilege or work product protection.

A party opposing a claim of patent infringement who does not comply with the requirements of this P. R. 3-7 shall not be permitted to rely on an opinion of counsel as part of a defense absent a stipulation of all parties or by order of the Court, which shall be entered only upon a showing of good cause.

3-8. Disclosure Requirements for Patent Cases Arising Under 21 U.S.C. § 355 (Hatch-Waxman Act).

The following provision applies to all patents subject to a Paragraph IV certification in cases arising under 21 U.S.C. § 355 (commonly referred to as “the Hatch-Waxman Act”). This provision takes precedence over any conflicting provisions in P.R. 3-1 to 3-5 for all cases arising under 21 U.S.C. § 355.

(a) Upon the filing of a responsive pleading to the complaint, the Defendant(s) shall produce to Plaintiff(s) the entire Abbreviated New Drug Application or New Drug Application that is the basis of the case in question.

(b) Not more than 7 days after the Initial Case Management Conference, Plaintiff(s) must identify the asserted claims.

(c) Not more than 14 days after the Initial Case Management Conference, the Defendant(s) shall provide to Plaintiff(s) the written basis for their “Invalidity Contentions” for any patents referred to in Defendant(s) Paragraph IV Certification. This written basis shall contain all disclosures required by P.R. 3-3 and shall be accompanied by the production of documents required by P.R. 3-4.

(d) Not more than 14 days after the Initial Case Management Conference, the Defendant(s) shall provide to Plaintiff(s) the written basis for any defense of non-infringement for any patent referred to in Defendant(s) Paragraph IV Certification. This written basis shall include a claim chart identifying each claim at issue in the case and each limitation of each claim at issue. The claim chart shall specifically identify for each claim those claim limitation(s) that are literally absent from the Defendant(s) allegedly infringing Abbreviated New Drug Application or New Drug Application. The written basis for any defense of non-infringement shall also be accompanied by the production of any document or thing that the Defendant(s) intend to rely upon in defense of any infringement allegations by Plaintiff(s).

(e) Not more than 45 days after the disclosure of the written basis for any defense of non-infringement as required by P.R. 3-8(c), Plaintiff(s) shall provide Defendant(s) with a “Disclosure of Asserted Claims and Infringement Contentions,” for all patents referred to in Defendant(s) Paragraph IV Certification, which shall contain all disclosures required by P.R. 3-1 and shall be accompanied by the production of documents required by P.R. 3-2.

(f) Each party that has an ANDA application pending with the Food and Drug Administration (“FDA”) that is the basis of the pending case shall: (1) notify the FDA of any and all motions for injunctive relief no later than three business days after the date on which such a motion is filed; and (2) provide a copy of all correspondence between itself and the FDA pertaining to the ANDA application to each party asserting infringement, or set forth the basis of any claim of privilege for such correspondence, no later than seven days after the date it sends or receives any such correspondence.

(g) Unless informed of special circumstances, the Court intends to set all Hatch-Waxman cases for final pretrial hearing at or near 24 months from the date of the filing of the complaint.

4. CLAIM CONSTRUCTION PROCEEDINGS

4-1. Exchange of Proposed Terms and Claim Elements for Construction.

(a) Not later than 10 days after service of the “Invalidity Contentions” pursuant to P. R. 3-3, each party shall simultaneously exchange a list of claim terms, phrases, or clauses which that party contends should be construed by the Court, and identify any claim element which that party contends should be governed by 35 U.S.C. § 112(6).

(b) The parties shall thereafter meet and confer for the purposes of finalizing this list, narrowing or resolving differences, and facilitating the ultimate preparation of a Joint Claim Construction and Prehearing Statement.

4-2. Exchange of Preliminary Claim Constructions and Extrinsic Evidence.

(a) Not later than 20 days after the exchange of “Proposed Terms and Claim Elements for Construction” pursuant to P. R. 4-1, the parties shall simultaneously exchange a preliminary proposed construction of each claim term, phrase, or clause which the parties collectively have identified for claim construction purposes. Each such “Preliminary Claim Construction” shall also, for each element which any party contends is governed by 35 U.S.C. § 112(6), identify the structure(s), act(s), or material(s) corresponding to that element.

(b) At the same time the parties exchange their respective “Preliminary Claim Constructions,” they shall each also provide a preliminary identification of extrinsic evidence, including without limitation, dictionary definitions, citations to learned treatises and prior art, and testimony of percipient and expert witnesses they contend support their respective claim constructions. The parties shall identify each such item of extrinsic evidence by production number or produce a copy of any such item not previously produced. With respect to any such witness, percipient or expert, the parties shall also provide a brief description of the substance of that witness’ proposed testimony.

(c) The parties shall thereafter meet and confer for the purposes of narrowing the issues and finalizing preparation of a Joint Claim Construction and Prehearing Statement.

4-3. Joint Claim Construction and Prehearing Statement.

Not later than 60 days after service of the “Invalidity Contentions,” the parties shall complete and file a Joint Claim Construction and Prehearing Statement, which shall contain the following information:

- (a) The construction of those claim terms, phrases, or clauses on which the parties agree;
- (b) Each party's proposed construction of each disputed claim term, phrase, or clause, together with an identification of all references from the specification or prosecution history that support that construction, and an identification of any extrinsic evidence known to the party on which it intends to rely either to support its proposed construction of the claim or to oppose any other party's proposed construction of the claim, including, but not limited to, as permitted by law, dictionary definitions, citations to learned treatises and prior art, and testimony of percipient and expert witnesses;
- (c) The anticipated length of time necessary for the Claim Construction Hearing;
- (d) Whether any party proposes to call one or more witnesses, including experts, at the Claim Construction Hearing, the identity of each such witness, and for each expert, a summary of each opinion to be offered in sufficient detail to permit a meaningful deposition of that expert; and
- (e) A list of any other issues which might appropriately be taken up at a prehearing conference prior to the Claim Construction Hearing, and proposed dates, if not previously set, for any such prehearing conference.

4-4. Completion of Claim Construction Discovery.

Not later than 30 days after service and filing of the Joint Claim Construction and Prehearing Statement, the parties shall complete all discovery relating to claim construction, including any depositions with respect to claim construction of any witnesses, including experts, identified in the Joint Claim Construction and Prehearing Statement.

4-5. Claim Construction Briefs.

- (a) Not later than 45 days after serving and filing the Joint Claim Construction and Prehearing Statement, the party claiming patent infringement shall serve and file an opening brief and any evidence supporting its claim construction. All asserted patents shall be attached as exhibits to the opening claim construction brief in searchable PDF form.
- (b) Not later than 14 days after service upon it of an opening brief, each opposing party shall serve and file its responsive brief and supporting evidence.
- (c) Not later than 7 days after service upon it of a responsive brief, the party claiming patent infringement shall serve and file any reply brief and any evidence

directly rebutting the supporting evidence contained in an opposing party's response.

(d) At least 10 days before the Claim Construction Hearing held pursuant to P.R. 4-6, the parties shall jointly file a claim construction chart.

(1) Said chart shall have a column listing complete language of disputed claims with disputed terms in bold type and separate columns for each party's proposed construction of each disputed term. The chart shall also include a fourth column entitled "Court's Construction" and otherwise left blank. Additionally, the chart shall also direct the Court's attention to the patent and claim number(s) where the disputed term(s) appear(s).

(2) The parties may also include constructions for claim terms to which they have agreed. If the parties choose to include agreed constructions, each party's proposed construction columns shall state "[AGREED]" and the agreed construction shall be inserted in the "Court's Construction" column.

(3) The purpose of this claim construction chart is to assist the Court and the parties in tracking and resolving disputed terms. Accordingly, aside from the requirements set forth in this rule, the parties are afforded substantial latitude in the chart's format so that they may fashion a chart that most clearly and efficiently outlines the disputed terms and proposed constructions. Appendices to the Court's prior published and unpublished claim construction opinions may provide helpful guidelines for parties fashioning claim construction charts.

(e) Unless otherwise ordered by the Court, the page limitations governing dispositive motions pursuant to Local Rule CV-7(a) shall apply to claim construction briefing.

4-6. Claim Construction Hearing.

Subject to the convenience of the Court's calendar, two weeks following submission of the reply brief specified in P.R. 4-5(c), the Court shall conduct a Claim Construction Hearing, to the extent the parties or the Court believe a hearing is necessary for construction of the claims at issue.

Appendix E

Model Patent Jury Instructions

The Federal Circuit Bar Association, Model Jury Instructions (January 2016), 3

Model Patent Jury Instructions for the Northern District of California (June 17, 2014), 102

AIPLA Model Patent Jury Instructions (2015), 172

FEDERAL CIRCUIT BAR ASSOCIATION

MODEL PATENT JURY INSTRUCTIONS

Last Edited: January 2016

© Federal Circuit Bar Association 2010

Acknowledgement

The Association thanks the Patent Litigation Committee and in particular the Jury Instruction Subcommittee for their efforts in creating these Model Patent Jury Instructions.

TABLE OF CONTENTS

A.1 Preliminary Instructions..... 2
WHAT A PATENT IS AND HOW ONE IS OBTAINED 2

A.2 Preliminary Instructions..... 4
SUMMARY OF CONTENTIONS..... 4

A.3 Preliminary Instructions..... 5
PATENT AT ISSUE..... 5

A.4 Preliminary Instructions..... 6
OVERVIEW OF APPLICABLE LAW 6

A.5 Preliminary Instructions..... 8
OUTLINE OF TRIAL 8

B.1 Summary of Contentions 11
SUMMARY OF CONTENTIONS..... 11

B.2 Claim Construction 12
2.1 THE ROLE OF THE CLAIMS OF A PATENT 12

B.2 Claim Construction 13
2.2 HOW A CLAIM DEFINES WHAT IT COVERS 13

B.2 Claim Construction 14
2.2a INDEPENDENT AND DEPENDENT CLAIMS 14

B.2 Claim Construction 15
2.3 CLAIM INTERPRETATION..... 15

B.2 Claim Construction 16
2.3a SECTION 112, PARAGRAPH 6 16

B.3 Infringement..... 18
3.1 INFRINGEMENT GENERALLY..... 18

B.3	Infringement.....	19
	3.1a DIRECT INFRINGEMENT BY “LITERAL INFRINGEMENT”	19
B.3	Infringement.....	20
	3.1b DIRECT INFRINGEMENT BY “LITERAL INFRINGEMENT” OF SECTION 112, PARAGRAPH 6 CLAIM REQUIREMENTS.....	20
B.3	Infringement.....	22
	3.1c DIRECT INFRINGEMENT UNDER THE DOCTRINE OF EQUIVALENTS .	22
B.3	Infringement.....	24
	3.1d LIMITATIONS ON DIRECT INFRINGEMENT UNDER THE DOCTRINE OF EQUIVALENTS.....	24
B.3	Infringement.....	27
	3.2 INDIRECT INFRINGEMENT—ACTIVE INDUCEMENT.....	27
B.3	Infringement.....	29
	3.3 INDIRECT INFRINGEMENT—CONTRIBUTORY INFRINGEMENT.....	29
B.3	Infringement.....	30
	3.4 INFRINGEMENT THROUGH THE SUPPLY OF COMPONENTS FROM UNITED STATES FOR COMBINATION ABROAD	30
B.3	Infringement.....	32
	3.5 INFRINGEMENT BY SALE, OFFER FOR SALE, USE, OR IMPORTATION OF A PRODUCT MADE OUTSIDE THE UNITED STATES BY PATENTED PROCESS	32
B.3	Infringement.....	33
	3.6 DIRECT INFRINGEMENT: ONE OR MORE SYSTEM COMPONENTS LOCATED OUTSIDE THE UNITED STATES	33
B.3	Infringement.....	34
	3.7 DIRECT INFRINGEMENT: ACTS OF MULTIPLE PARTIES MUST BE COMBINED TO MEET ALL CLAIM LIMITATIONS.....	34
B.3	Infringement.....	35

3.8	[DELETED] INDIRECT INFRINGEMENT: ACCUSED INFRINGER PRACTICES SOME CLAIMED STEPS AND ANOTHER PRACTICES THE REMAINING STEPS	35
B.3	Infringement.....	36
3.9	[DELETED] INDIRECT INFRINGEMENT: ACCUSED INFRINGER ALLEGEDLY INDUCES OTHERS TO COLLECTIVELY PRACTICE ALL CLAIMED STEPS.....	36
B.3	Infringement.....	37
3.10	WILLFUL INFRINGEMENT	37
B.4	Validity	39
4.1	INVALIDITY—BURDEN OF PROOF.....	39
B.4.2	Validity—Adequacy of Patent Specification.....	40
4.2a	WRITTEN DESCRIPTION REQUIREMENT	40
B.4.2	Validity—Adequacy of Patent Specification.....	41
4.2b	ENABLEMENT	41
B.4.2	Validity—Adequacy of Patent Specification.....	43
4.2c	[DELETED] BEST MODE	43
B.4.3	Validity—The Claims.....	44
4.3a-1	PRIOR ART (For Patents Having an Effective Filing Date Before March 16, 2013)	44
B.4.3	Validity—The Claims.....	46
4.3b-1	ANTICIPATION (For Patents Having an Effective Filing Date Before March 16, 2013)	46
4.3a-2	PRIOR ART (For Patents Having an Effective Filing Date on or After March 16, 2013)	48
B.4.3	Validity—The Claims.....	49
4.3c	OBVIOUSNESS.....	49
B.4.3	Validity—The Claims.....	51

4.3c(i) LEVEL OF ORDINARY SKILL	51
4.3c(ii) SCOPE AND CONTENT OF THE PRIOR ART	51
B.4.3 Validity—The Claims	53
4.3d INVENTORSHIP	53
B.5 Equitable Defenses.....	54
5.1 INEQUITABLE CONDUCT.....	54
B.5 Equitable Defenses.....	56
5.2 LACHES	56
B.5 Equitable Defenses.....	58
5.3 EQUITABLE ESTOPPEL.....	58
B.5 Equitable Defenses.....	59
5.4 PROSECUTION LACHES	59
B.5. Equitable Defenses.....	60
5.5 UNCLEAN HANDS.....	60
B.6 Patent Damages.....	61
6.1 DAMAGES—INTRODUCTION.....	61
B.6 Patent Damages.....	63
6.2 LOST PROFITS—“BUT FOR” TEST.....	63
LOST PROFITS—DEMAND	64
LOST PROFITS—NONINFRINGEMENT SUBSTITUTES—ACCEPTABILITY	64
LOST PROFITS—NONINFRINGEMENT SUBSTITUTES—AVAILABILITY	64
LOST PROFITS—CAPACITY	66
LOST PROFITS—AMOUNT OF PROFIT	66
LOST PROFITS—MARKET SHARE.....	67
B.6 Patent Damages.....	68

Appendix E: Model Patent Jury Instructions

6.3	LOST PROFITS—COLLATERAL SALES	68
B.6	Patent Damages.....	69
6.4	LOST PROFITS—PRICE EROSION	69
B.6	Patent Damages.....	70
6.5	REASONABLE ROYALTY—ENTITLEMENT	70
B.6	Patent Damages.....	71
6.6	REASONABLE ROYALTY—DEFINITION	71
B.6	Patent Damages.....	72
6.7	REASONABLE ROYALTY—RELEVANT FACTORS	72
B.6	Patent Damages.....	75
6.8	DATE OF COMMENCEMENT OF DAMAGES—PRODUCTS.....	75
C.	Appendix.....	77
	GLOSSARY	77

TABLE OF AUTHORITIES

	Page(s)
Cases	
<i>A.C. Aukerman Co. v. R.L. Chaides Constr. Co.</i> , 960 F.2d 1020 (Fed. Cir. 1992) (en banc).....	57, 58
<i>Abbott Labs. v. Geneva Pharms., Inc.</i> , 182 F.3d 1315 (Fed. Cir. 1999).....	47
<i>Ajinomoto Co. v. Archer-Daniels-Midland Co.</i> , 228 F.3d 1338 (Fed. Cir. 2000).....	32, 42
<i>AK Steel Corp. v. Sollac & Ugine</i> , 344 F.3d 1234 (Fed. Cir. 2003).....	13, 42
<i>Al-Site Corp. v. VSI Int’l Inc.</i> , 174 F.3d 1308 (Fed. Cir. 1999).....	16, 21, 23, 26
<i>Alloc, Inc. v. ITC</i> , 342 F.3d 1361 (Fed. Cir. 2003).....	29
<i>Allvoice Computing PLC v. Nuance Commc’ns, Inc.</i> , 504 F.3d 1236 (Fed. Cir. 2007).....	16, 21
<i>In re Alton</i> , 76 F.3d 1168 (Fed. Cir. 1996).....	40
<i>Am. Med. Sys. v. Med. Eng’g Corp.</i> , 6 F.3d 1523 (Fed. Cir. 1993).....	75, 76
<i>Am. Seating Co. v. USSC Group</i> , 514 F.3d 1262 (Fed. Cir. 2008).....	64
<i>Am. Stock Exch., LLC v. Mopex, Inc.</i> , 250 F. Supp. 2d 323 (S.D.N.Y. 2003).....	47
<i>Apotex U.S.A., Inc. v. Merck & Co.</i> , 254 F.3d 1031 (Fed. Cir. 2001).....	47
<i>Applied Med. Res. Corp. v. U.S. Surgical Corp.</i> , 448 F.3d 1324 (Fed. Cir. 2006).....	16, 21
<i>Aptix Corp. v. Quickturn Design Sys., Inc.</i> , 269 F.3d 1369 (Fed. Cir. 2001).....	60

Appendix E: Model Patent Jury Instructions

<i>Ariad Pharmaceuticals, Inc. v. Eli Lilly & Co.</i> , 598 F.3d 1336 (Fed. Cir. 2010) (en banc).....	40
<i>Aro Mfg. Co. v. Convertible Top Replacement Co.</i> , 377 U.S. 476 (1964).....	29, 63
<i>Auto. Techs. Int’l, Inc. v. BMW of N. Am., Inc.</i> , 501 F.3d 1274 (Fed. Cir. 2007).....	42
<i>Aventis Pharma Deutschland GmbH v. Lupin, Ltd.</i> , 499 F.3d 1293 (Fed. Cir. 2007).....	52
<i>Bard Peripheral Vascular, Inc. v. W.L. Gore & Assocs., Inc.</i> , 682 F.3d 1003 (Fed. Cir. 2012).....	37
<i>In re Bartfeld</i> , 925 F.2d 1450 (Fed. Cir. 1991).....	47
<i>Bayer AG v. Housey Pharms., Inc.</i> , 340 F.3d 1367 (Fed. Cir. 2003).....	32
<i>BIC Leisure Prods., Inc. v. Windsurfing Int’l, Inc.</i> , 1 F.3d 1214 (Fed. Cir. 1993).....	63, 64, 67, 69
<i>In re Bogese II</i> , 303 F.3d 1362 (Fed. Cir. 2002).....	59
<i>Buildex, Inc. v. Kason Indus., Inc.</i> , 849 F.2d 1461 (Fed. Cir. 1988).....	39
<i>Burroughs Wellcome Co. v. Barr Labs., Inc.</i> , 40 F.3d 1223 (Fed. Cir. 1994).....	53
<i>Calico Brand, Inc. v. Ameritek Imps., Inc.</i> , 527 Fed. Appx. 987 (Fed. Cir. 2013).....	61
<i>Cardiac Pacemakers, Inc. v. St. Jude Med.</i> , 576 F.3d 1348 (Fed. Cir. 2009).....	31
<i>Carella v. Starlight Archery</i> , 804 F.2d 135 (Fed. Cir. 1986).....	63
<i>Chiron Corp. v. Genentech, Inc.</i> , 363 F.3d 1247 (Fed. Cir. 2004).....	40
<i>Chiuminatta Concrete Concepts, Inc. v. Cardinal Indus., Inc.</i> , 145 F.3d 1303 (Fed. Cir. 1998).....	17, 21

<i>CIAS, Inc. v. Alliance Gaming Corp.</i> , 504 F.3d 1356 (Fed. Cir. 2007).....	13
<i>Circuit Check, Inc. v. QXQ Inc.</i> , 795 F.3d 1331 (Fed. Cir. 2015).....	52
<i>Commil USA, LLC v. Cisco Sys.</i> , 720 F.3d 1361 (Fed. Cir. 2013).....	28
<i>Conoco, Inc. v. Energy & Env'tl. Int'l, L.C.</i> , 460 F.3d 1349 (Fed. Cir. 2006).....	13
<i>Cook Biotech Inc. v. ACell, Inc.</i> , 460 F.3d 1365 (Fed. Cir. 2006).....	13
<i>Cordis Corp. v. Medtronic Ave., Inc.</i> , 511 F.3d 1157 (Fed. Cir. 2008).....	51
<i>Cross Med. Prods. v. Medtronic Sofamor Danek</i> , 424 F.3d 1293 (Fed. Cir. 2005).....	19, 21
<i>Crown Cork & Seal Co. v. Ferdinand Gutmann Co.</i> , 304 U.S. 159 (1938).....	59
<i>Crystal Semiconductor Corp. v. Tritech Microelectronics Int'l, Inc.</i> , 246 F.3d 1336 (Fed. Cir. 2001).....	<i>passim</i>
<i>Cybor Corp. v. FAS Techs.</i> , 138 F.3d 1448 (Fed. Cir. 1998).....	15
<i>D.L. Auld Co. v. Chroma Graphics Corp.</i> , 714 F.2d 1144 (Fed. Cir. 1983).....	47
<i>Daiichi Sankyo Co. v. Apotex, Inc.</i> , 501 F.3d 1254 (Fed. Cir. 2007).....	52
<i>DePuy Spine, Inc. v. Medtronic Sofamor Danek, Inc.</i> , 567 F.3d 1314 (Fed. Cir. 2009).....	64
<i>Devices for Med., Inc. v. Boehl</i> , 822 F.2d 1062 (Fed. Cir. 1987).....	75
<i>Dolly, Inc. v. Spalding & Evenflo Cos.</i> , 16 F.3d 394 (Fed. Cir. 1994).....	23
<i>Dow Chem. Co. v. Mee Indus., Inc.</i> , 341 F.3d 1370 (Fed. Cir. 2003).....	62

Appendix E: Model Patent Jury Instructions

<i>DSU Med. Corp. v. JMS Co.</i> , 471 F.3d 1293 (Fed. Cir. 2006).....	28
<i>Ecolochem, Inc. v. S. Cal. Edison Co.</i> , 227 F.3d 1361 (Fed. Cir. 2000).....	47
<i>Eli Lilly & Co. v. Aradigm Corp.</i> , 376 F.3d 1352 (Fed. Cir. 2004).....	53
<i>Energy Transp. Group, Inc. v. William Demant Holding A/S</i> , 697 F.3d 1342 (Fed. Cir. 2012).....	74
<i>Ericsson, Inc. v. D-Link Sys.</i> , 773 F.3d 1201 (Fed. Cir. 2014).....	61, 74
<i>Ericsson, Inc. v. Harris Corp.</i> , 352 F.3d 1369 (Fed. Cir. 2003).....	63, 69
<i>Esai Co. v. Dr. Reddy's Labs. Ltd.</i> , 533 F.3d 1353 (Fed. Cir. 2008).....	51
<i>Ferguson Beauregard/Logic Controls, Div. of Dover Res., Inc. v. Mega Sys., LLC</i> , 350 F.3d 1327 (Fed. Cir. 2003).....	28
<i>Festo Corp. v. Shoketsu Kinzoku Kogyo Kabushiki Co.</i> , 344 F.3d 1359 (Fed. Cir. 2003) (en banc).....	26
<i>Festo Corp. v. Shoketsu Kinzoku Kogyo Kabushiki Co.</i> , 535 U.S. 722 (2002).....	23
<i>Finnigan Corp. v. ITC</i> , 180 F.3d 1354 (Fed. Cir. 1999).....	47
<i>Flex-Rest, LLC v. Steelcase, Inc.</i> , 455 F.3d 1351 (Fed. Cir. 2006).....	47
<i>Fonar Corp. v. Gen. Elec. Co.</i> , 107 F.3d 1543 (Fed. Cir. 1997).....	66
<i>Fromson v. W. Litho Plate & Supply Co.</i> , 853 F.2d 1568 (Fed. Cir. 1998).....	70
<i>Gambro Lundia AB v. Baxter Healthcare Corp.</i> , 110 F.3d 1573 (Fed. Cir. 1997).....	47
<i>Gargoyles, Inc. v. United States</i> , 113 F.3d 1572 (Fed. Cir. 1997).....	63

<i>Gasser Chair Co. v. Infanti Chair Mfg. Corp.</i> , 60 F.3d 770 (Fed. Cir. 1995).....	57, 58
<i>Gen. Talking Pictures Corp. v. W. Elec. Co.</i> , 304 U.S. 175 (1938).....	59
<i>Gentry Gallery, Inc. v. Berkline Corp.</i> , 134 F.3d 1473 (Fed. Cir. 1998).....	40
<i>Georgia-Pacific Corp. v. U.S. Plywood Corp.</i> , 318 F. Supp. 1116 (S.D.N.Y. 1970).....	71, 72, 74
<i>Global-Tech Appliances, Inc. v. SEB S. A.</i> , 563 U.S. 754	28, 31
<i>Golight, Inc. v. Wal-Mart Stores, Inc.</i> , 355 F.3d 1327 (Fed. Cir. 2004).....	71, 74
<i>Graham v. John Deere Co.</i> , 383 U.S. 1 (1966).....	51
<i>Grain Processing Corp. v. Am. Maize-Prods. Co.</i> , 185 F.3d 1341 (Fed. Cir. 1999).....	62, 65
<i>Graver Tank & Mfg. Co. v. Linde Air Prods. Co.</i> , 339 U.S. 605 (1950).....	23
<i>Gustafson, Inc. v. Intersystems Indus. Prods., Inc.</i> , 897 F.2d 508 (Fed. Cir. 1990).....	38
<i>Gyromat Corp. v. Champion Spark Plug Co.</i> , 735 F.2d 549 (Fed. Cir. 1984).....	63, 66
<i>In re Hall</i> , 781 F.2d 897 (Fed. Cir. 1986).....	47
<i>Helifix Ltd. v. Blok-Lok, Ltd.</i> , 208 F.3d 1339 (Fed. Cir. 2000).....	47
<i>Hess v. Advanced Cardiovascular Sys. Inc.</i> , 106 F.3d 976 (Fed. Cir. 1997).....	53
<i>Hewlett-Packard Co. v. Bausch & Lomb, Inc.</i> , 909 F.2d 1464 (Fed. Cir. 1990).....	29
<i>Honeywell Int’l v. Hamilton Sundstrand Corp.</i> , 370 F.3d 1131 (Fed. Cir. 2004).....	26

Appendix E: Model Patent Jury Instructions

<i>Hughes Aircraft Co. v. United States</i> , 140 F.3d 1470 (Fed. Cir. 1998).....	23
<i>Hybritech Inc. v. Monoclonal Antibodies, Inc.</i> , 802 F.2d 1367 (Fed. Cir. 1986).....	39, 52
<i>In re Icon Health & Fitness, Inc.</i> , 496 F.3d 1374 (Fed. Cir. 2007).....	52
<i>Insituform Techs., Inc. v. CAT Contracting, Inc.</i> , 385 F.3d 1360 (Fed. Cir. 2004).....	28
<i>Integra Lifesciences I, Ltd. v. Merck KGaA</i> , 331 F.3d 860 (Fed. Cir. 2003).....	62
<i>Interactive Pictures Corp. v. Infinite Pictures Inc.</i> , 274 F.3d 1371 (Fed. Cir. 2001).....	23, 26, 71
<i>Invitrogen Corp. v. Biocrest Mfg., L.P.</i> , 327 F.3d 1364 (Fed. Cir. 2003).....	13
<i>Invitrogen Corp. v. Biocrest Mfg., L.P.</i> , 424 F.3d 1374 (Fed. Cir. 2005).....	47
<i>J.A. LaPorte, Inc. v. Norfolk Dredging Co.</i> , 787 F.2d 1577 (Fed. Cir. 1986).....	47
<i>Johnson & Johnston Assocs. v. R.E. Serv. Co.</i> , 285 F.3d 1046 (Fed. Cir. 2002).....	23
<i>Kalman v. Berlyn Corp.</i> , 914 F.2d 1473 (Fed. Cir. 1990).....	69
<i>Kendall v. Winsor</i> , 62 U.S. 322 (1859).....	59
<i>Keystone Driller Co. v. Gen. Excavator Co.</i> , 290 U.S. 240 (1933).....	60
<i>Kim v. ConAgra Foods, Inc.</i> , 465 F.3d 1312 (Fed. Cir. 2006).....	19
<i>In re Klopfenstein</i> , 380 F.3d 1345 (Fed. Cir. 2004).....	47
<i>Knorr-Bremse v. Dana Corp.</i> , 383 F.3d 1337 (Fed. Cir. 2004) (en banc).....	38

<i>KSR International Co. v. Teleflex Inc.</i> , 550 U.S. 398 (2007).....	51, 52
<i>Lam, Inc. v. Johns-Manville Corp.</i> , 718 F.2d 1056 (Fed. Cir. 1983).....	62
<i>Lamb-Weston, Inc. v. McCain Foods, Ltd.</i> , 78 F.3d 540 (Fed. Cir. 1996).....	47
<i>Lampi Corp. v. Am. Power Prods., Inc.</i> , 228 F.3d 1365 (Fed. Cir. 2000).....	40
<i>Limelight Networks, Inc. v. Akamai Technologies, Inc.</i> , 797 F.3d 1020, 1022-24 (Fed. Cir. 2015) (en banc)	34
<i>Liquid Dynamics Corp. v. Vaughan Co.</i> , 449 F.3d 1209 (Fed. Cir. 2006).....	31
<i>Lizard Tech., Inc. v. Earth Res. Mapping Inc.</i> , 424 F.3d 1336 (Fed. Cir. 2005).....	40
<i>Lucent Technologies, Inc. v. Gateway, Inc.</i> , 580 F.3d 1301 (Fed. Cir. 2009).....	<i>passim</i>
<i>Mahurkar v. C.R. Bard, Inc.</i> , 79 F.3d 1572 (Fed. Cir. 1996).....	70, 71, 74
<i>Markman v. Westview Instruments, Inc.</i> , 517 U.S. 370 (1996).....	15
<i>Markman v. Westview Instruments, Inc.</i> , 52 F.3d 967 (Fed. Cir. 1995).....	15
<i>Maxwell v. J. Baker, Inc.</i> , 86 F.3d 1098 (Fed. Cir. 1996).....	62, 71, 74, 75
<i>Mentor H/S, Inc. v. Med. Device Alliance, Inc.</i> , 244 F.3d 1365 (Fed. Cir. 2001).....	29
<i>MGM Studios Inc. v. Grokster</i> , 419 F.3d 1005 (Fed. Cir. 2005).....	28
<i>Micro Chem., Inc. v. Great Plains Chem. Co.</i> , 103 F.3d 1538 (Fed. Cir. 1997).....	21
<i>Micro Chem., Inc. v. Lextron, Inc.</i> , 318 F.3d 1119 (Fed. Cir. 2003).....	63, 65, 67

Appendix E: Model Patent Jury Instructions

<i>Microsoft Corp. v. AT&T Corp.</i> , 550 U.S. 437 (2007).....	31
<i>Microsoft Corp. v. i4i Limited Partnerhsip</i> , 131 S.Ct. 2238 (2011).....	39, 52
<i>MicroStrategy Inc. v. Bus. Objects, S.A.</i> , 429 F.3d 1344 (Fed. Cir. 2005).....	19
<i>Minco, Inc. v. Combustion Eng’g, Inc.</i> , 95 F.3d 1109 (Fed. Cir. 1996).....	69, 70
<i>Moleculon Research Corp. v. CBS, Inc.</i> , 793 F.2d 1261 (Fed. Cir. 1986).....	19
<i>Morton Int’l, Inc. v. Cardinal Chem. Co.</i> , 5 F.3d 1464 (Fed. Cir. 1993).....	18
<i>Multiform Desiccants, Inc. v. Medzam, Ltd.</i> , 133 F.3d 1473 (Fed. Cir. 1998).....	23
<i>Muniauction Inc. v. Thomson Corp.</i> , 532 F.3d 1318 (Fed. Cir. 2008).....	28
<i>Mycogen Plant Sci., Inc. v. Monsanto Co.</i> , 243 F.3d 1316 (Fed. Cir. 2001).....	47
<i>Netword, LLC v. Centraal Corp.</i> , 242 F.3d 1347 (Fed. Cir. 2001).....	19
<i>Nike Inc. v. Wal-Mart Stores</i> , 138 F.3d 1437 (Fed. Cir. 1998).....	75
<i>NTP, Inc. v. Research in Motion, Ltd.</i> , 418 F.3d 1282 (Fed. Cir. 2005).....	31, 33
<i>O2 Micro Int’l Ltd. v. Beyond Innovation Tech. Co.</i> , 521 F.3d 1351 (Fed. Cir. 2008).....	15
<i>Odetics, Inc. v. Storage Tech. Corp.</i> , 185 F.3d 1259 (Fed. Cir. 1999).....	17, 21
<i>Omega Eng’g, Inc. v. Raytek Corp.</i> , 334 F.3d 1314 (Fed. Cir. 2003).....	21
<i>Panduit Corp. v. Stahlin Bros. Fibre Works, Inc.</i> , 575 F.2d 1152 (6th Cir. 1978)	63, 64, 68

<i>Pannu v. Iolab Corp.</i> , 155 F.3d 1344 (Fed. Cir. 1998).....	47, 53
<i>Paper Converting Mach. Co. v. Magna-Graphics Corp.</i> , 745 F.2d 11 (Fed. Cir. 1984).....	66
<i>Pellegrini v. Analog Devices, Inc.</i> , 375 F.3d 1113 (Fed. Cir. 2004).....	31
<i>Pfaff v. Wells Elecs. Inc.</i> , 525 U.S. 55 (1998).....	47
<i>Phillips v. AWH Corp.</i> , 415 F.3d 1303 (Fed. Cir. 2005) (en banc).....	15
<i>Pitney Bowes, Inc. v. Hewlett-Packard Co.</i> , 182 F.3d 1298 (Fed. Cir. 1999).....	15
<i>Preemption Devices, Inc. v. Minn. Mining & Mfg. Co.</i> , 803 F.2d 1170 (Fed. Cir. 1986).....	29
<i>Princeton Biochems., Inc. v. Beckman Coulter, Inc.</i> , 411 F.3d 1332 (Fed. Cir. 2005).....	52
<i>Purdue Pharma L.P. v. Faulding, Inc.</i> , 230 F.3d 1320 (Fed. Cir. 2000).....	40
<i>Ralston Purina Co. v. Far-Mar-Co, Inc.</i> , 772 F.2d 1570 (Fed. Cir. 1985).....	47
<i>Read Corp. v. Portec, Inc.</i> , 970 F.2d 816 (Fed. Cir. 1992).....	38
<i>Regents of the Univ. of Cal. v. Eli Lilly & Co.</i> , 119 F.3d 1559 (Fed. Cir. 1997).....	40
<i>ResQNet.com, Inc. v. Lansa, Inc.</i> , 594 F.3d 860 (Fed. Cir. 2010).....	62, 71, 74
<i>Ricoh Co. v. Quanta Computer Inc.</i> , 550 F.3d 1325 (Fed. Cir. 2008), <i>cert denied</i> , 129 S. Ct. 2864 (2009).....	29
<i>Rite-Hite Corp. v. Kelley Co.</i> , 56 F.3d 1538 (Fed. Cir. 1995) (en banc).....	<i>passim</i>
<i>Ruiz v. A.B. Chance Co.</i> , 234 F.3d 654 (Fed. Cir. 2000).....	51, 52

Appendix E: Model Patent Jury Instructions

<i>Schering Corp. v. Geneva Pharms., Inc.</i> , 339 F.3d 1373 (Fed. Cir. 2003).....	47
<i>Schumer v. Lab. Computer Sys., Inc.</i> , 308 F.3d 1304 (Fed. Cir. 2002).....	39
<i>In re Seagate Tech., LLC</i> , 497 F.3d 1360 (Fed. Cir. 2007).....	38
<i>Seal-Flex, Inc. v. Athletic Track & Court Constr.</i> , 172 F.3d 836 (Fed. Cir. 1999).....	18
<i>Shatterproof Glass Corp. v. Libbey-Owens Ford Co.</i> , 758 F.2d 613 (Fed. Cir. 1985).....	53
<i>Singh v. Brake</i> , 222 F.3d 1362 (Fed. Cir. 2000).....	47
<i>Sitrick v. Dreamworks, LLC</i> , 516 F.3d 993 (Fed. Cir. 2008).....	41
<i>SmithKline Diagnostics, Inc. v. Helena Lab. Corp.</i> , 926 F.2d 1161 (Fed. Cir. 1991).....	64
<i>Standard Havens Prods., Inc. v. Gencor Indus., Inc.</i> , 953 F.2d 1360 (Fed. Cir. 1991).....	62, 64
<i>State Indus., Inc. v. Mor-Flo Indus., Inc.</i> , 883 F.2d 1573 (Fed. Cir. 1989).....	67, 68
<i>Symbol Techs., Inc. v. Lemelson Med., Educ. & Research Found., L.P.</i> , 277 F.3d 1361 (Fed. Cir. 2002).....	59
<i>Symbol Techs., Inc. v. Lemelson Med., Educ. & Research Found., L.P.</i> , 301 F. Supp. 2d 1147 (D. Nev. 2004), <i>aff'd</i> , 422 F.3d 1378 (Fed. Cir. 2005)	59
<i>Takeda Chem. Indus., Ltd. v. Alphapharm Pty., Ltd.</i> , 492 F.3d 1350 (Fed. Cir. 2007).....	52
<i>Therasense Inc. v. Becton, Dickinson and Co.</i> , 649 F.3d 1276 (Fed. Cir. 2011) (en banc).....	55
<i>Toro Co. v. Deere & Co.</i> , 355 F.3d 1313 (Fed. Cir. 2004).....	47
<i>Trans-World Mfg. Corp. v. Al Nyman & Sons, Inc.</i> , 750 F.2d 1552 (Fed. Cir. 1984).....	71

<i>Uniloc USA, Inc. v. Microsoft Corp.</i> , 632 F.3d 1292 (Fed. Cir. 2011).....	71, 74
<i>Union Carbide Chems. & Plastics Tech. Corp. v. Shell Oil Co.</i> , 425 F.3d 1366 (Fed. Cir. 2005).....	31
<i>Union Pac. Res. Co. v. Chesapeake Energy Corp.</i> , 236 F.3d 684 (Fed. Cir. 2001).....	42
<i>Univ. of Rochester v. G.D. Searle & Co.</i> , 358 F.3d 916 (Fed. Cir. 2004).....	40
<i>Valmont Indus., Inc. v. Reinke Mfg. Co.</i> , 983 F.2d 1039 (Fed. Cir. 1993).....	21
<i>Vehicular Techs. Corp. v. Titan Wheel Int’l, Inc.</i> , 212 F.3d 1377 (Fed. Cir. 2000).....	13
<i>Virnetx, Inc. v. Cisco Sys., Inc.</i> , 767 F.3d 1308 (Fed. Cir. 2014).....	61
<i>Vulcan Eng’g Co. v. FATA Aluminum, Inc.</i> , 278 F.3d 1366 (Fed. Cir. 2002).....	69
<i>In re Wands</i> , 858 F.2d 731 (Fed. Cir. 1988).....	42
<i>Warner-Jenkinson Co. v. Hilton Davis Chem. Co.</i> , 520 U.S. 17 (1997).....	23
<i>Warner-Lambert Co. v. Apotex Corp.</i> , 316 F.3d 1348 (Fed. Cir. 2003).....	28
<i>Warner-Lambert Co. v. Teva Pharms. USA, Inc.</i> , 418 F.3d 1326 (Fed. Cir. 2005).....	18
<i>Waymark Corp. v. Porta Sys., Corp.</i> , 245 F.3d 1364 (Fed. Cir. 2001).....	31
<i>Webster Elec. Co. v. Splitdorf Elec. Co.</i> , 264 U.S. 463 (1924).....	59
<i>Wilson Sporting Goods Co. v. David Geoffrey & Assocs.</i> , 904 F.2d 676 (Fed. Cir. 1990).....	26
<i>WMS Gaming Inc. v. Int’l Game Tech.</i> , 184 F.3d 1339 (Fed. Cir. 1999).....	17, 21, 38

Appendix E: Model Patent Jury Instructions

Woodbridge v. United States,
263 U.S. 50 (1923).....59

In re Wyer,
655 F.2d 221 (C.C.P.A. 1981)47

Statutes

35 U.S.C. § 101, 102, 103, 112.....39

35 U.S.C. §§ 102, 256.....53

35 U.S.C. § 102(a)(1)-(2).....48

35 U.S.C. § 102(a)-(g)47

35 U.S.C. § 102(b)(1)-(2)48

35 U.S.C. § 103.....51

35 U.S.C. § 112, ¶ 141

35 U.S.C. § 112, ¶¶ 1, 240

35 U.S.C. § 112, ¶ 6.....16, 17, 20, 21

35 U.S.C. § 271(a)33, 34, 35, 36

35 U.S.C. § 271(b)28, 35, 36

35 U.S.C. § 271(c)29

35 U.S.C. § 271(f).....31

35 U.S.C. § 271(f)(1)30

35 U.S.C. § 271(g)32

35 U.S.C. § 282..... *passim*

35 U.S.C. § 284.....38, 61, 63, 70

35 U.S.C. § 287.....75, 76

35 U.S.C. § 287(a)76

35 U.S.C. § 287(c)(2)(F).....76

Preliminary Instructions

A.1 Preliminary Instructions

WHAT A PATENT IS AND HOW ONE IS OBTAINED

This case involves a dispute relating to a United States patent. Before summarizing the positions of the parties and the issues involved in the dispute, let me take a moment to explain what a patent is and how one is obtained.

Patents are granted by the United States Patent and Trademark Office (sometimes called “the PTO”). A valid United States patent gives the patent holder the right [for up to 20 years from the date the patent application was filed] [for 17 years from the date the patent issued] to prevent others from making, using, offering to sell, or selling the patented invention within the United States, or from importing it into the United States, without the patent holder’s permission. A violation of the patent holder’s rights is called infringement. The patent holder may try to enforce a patent against persons believed to be infringers by a lawsuit filed in federal court.

The process of obtaining a patent is called patent prosecution. To obtain a patent, one must first file an application with the PTO. The PTO is an agency of the Federal Government and employs trained Examiners who review applications for patents. The application includes what is called a “specification,” which contains a written description of the claimed invention telling what the invention is, how it works, how to make it, and how to use it. The specification concludes with one or more numbered sentences. These are the patent “claims.” When the patent is eventually granted by the PTO, the claims define the boundaries of its protection and give notice to the public of those boundaries.

After the applicant files the application, an Examiner reviews the application to determine whether or not the claims are patentable (appropriate for patent protection) and whether or not the specification adequately describes the invention claimed. In examining a patent application, the Examiner reviews certain information about the state of the technology at the time the application was filed. The PTO searches for and reviews information that is publicly available or that is submitted by the applicant. This information is called “prior art.” The Examiner reviews this prior art to determine whether or not the invention is truly an advance over the state of the art at the time. Prior art is defined by law, and I will give you, at a later time during these instructions, specific instructions as to what constitutes prior art. However, in general, prior art includes information that demonstrates the state of technology that existed before the claimed invention was made or before the application was filed. A patent lists the prior art that the Examiner considered; this list is called the “cited references.”

After the prior art search and examination of the application, the Examiner informs the applicant in writing of what the Examiner has found and whether the Examiner considers any claim to be patentable and, thus, would be “allowed.” This writing from the Examiner is called an “Office Action.” If the Examiner rejects the claims, the applicant has an opportunity to respond to the Examiner to try to persuade the Examiner to allow the claims, and to change the claims or to submit new claims. This process may go back and forth for some time until the Examiner is satisfied that the application meets the requirements for a patent and the application issues as a patent, or that the application should be rejected and no patent should issue. Sometimes, patents

are issued after appeals within the PTO or to a court. The papers generated during these communications between the Examiner and the applicant are called the “prosecution history.”

The fact that the PTO grants a patent does not necessarily mean that any invention claimed in the patent, in fact, deserves the protection of a patent. For example, the PTO may not have had available to it all other prior art that will be presented to you. A person accused of infringement has the right to argue here in federal court that a claimed invention in the patent is invalid because it does not meet the requirements for a patent. It is your job to consider the evidence presented by the parties and determine independently whether or not [alleged infringer] has proven that the patent is invalid.

A.2 Preliminary Instructions

SUMMARY OF CONTENTIONS

To help you follow the evidence, I will now give you a summary of the positions of the parties.

The parties in this case are [patent holder] and [alleged infringer]. The case involves United States Patent No(s). [], obtained by [inventor], and transferred by [inventor] to [patent holder]. For your convenience, the parties and I will often refer to this patent number [full patent number] by the last three numbers of the patent number, namely, as the “[last three numbers of the patent] patent.”

[Patent holder] filed suit in this court seeking money damages from [alleged infringer] for allegedly infringing the [] patent by [making], [importing], [using], [selling], [offering for sale], [supplying or causing to be supplied in or from the United States all or a substantial portion of the components of a patented invention] [in/into/within] the United States [products] [methods] [products which are made by a process patented in the United States] that [patent holder] argues are covered by claims [] of the [] patent. [[Patent holder] also argues that [alleged infringer] has [actively induced infringement of these claims of the [] patent by others] [and/or] [contributed to the infringement of claims [] of the [] patent by others].]

The [products] [methods] that are alleged to infringe are [list of accused products or methods].

[Alleged infringer] denies that it has infringed claims [] of the [] patent. [Alleged infringer] also argues that claims [] are invalid. I will instruct you later as to the ways in which a patent may be invalid. In general, however, a patent is invalid if it is not new or is obvious in view of the state of the art at the relevant time, or if the description in the patent does not meet certain requirements. [Add other defenses, if applicable.]

Your job will be to decide whether or not claims [] of the [] patent have been infringed and whether or not those claims are invalid. If you decide that any claim of the [] patent has been infringed and is not invalid, you will then need to decide any money damages to be awarded to [patent holder] to compensate it for the infringement. [You will also need to make a finding as to whether the infringement was willful. If you decide that any infringement was willful, that decision should not affect any damages award you give. I will take willfulness into account later.]

A.3 Preliminary Instructions

PATENT AT ISSUE

[The Court should show the jury the patent at issue and point out the parts, which include the specification, drawings, and claims, including the claims at issue. The Court may wish to include a joint, nonargumentative statement of the patented subject matter at this point in the instructions.

The Court may wish to hand out its claim constructions (if the claims have been construed at this point) and the glossary at this time. If the claim constructions are handed out, the following instruction should be read:]

I have already determined the meaning of the claims of the [] patent. You have been given a document reflecting those meanings. For a claim term for which I have not provided you with a definition, you should apply the ordinary meaning. You are to apply my definitions of these terms throughout this case. However, my interpretation of the language of the claims should not be taken as an indication that I have a view regarding issues such as infringement and invalidity. Those issues are yours to decide. I will provide you with more detailed instructions on the meaning of the claims before you retire to deliberate your verdict.

A.4 Preliminary Instructions

OVERVIEW OF APPLICABLE LAW

[The Court may wish to give preliminary instructions that are applicable to the specific issues in the case. This may help focus the jury on the facts that are relevant to the issues it will have to decide. Even if preliminary instructions are given, the Court would, nonetheless, give complete instructions at the close of evidence.]

In deciding the issues I just discussed, you will be asked to consider specific legal standards. I will give you an overview of those standards now and will review them in more detail before the case is submitted to you for your verdict.

The first issue you will be asked to decide is whether [alleged infringer] has infringed the claims of the [] patent. Infringement is assessed on a claim-by-claim basis. Therefore, there may be infringement as to one claim but not infringement as to another. There are a few different ways that a patent may be infringed. I will explain the requirements for each of these types of infringement to you in detail at the conclusion of the case. In general, however, [alleged infringer] may infringe the [] patent by making, using, selling, or offering for sale in the United States, or by importing into the United States, a product or by using a method meeting all the requirements of a claim of the [] patent. [Alleged infringer] may also indirectly infringe the [] patent by contributing to infringement by another entity, or by inducing another person or entity to infringe. I will provide you with more detailed instructions on the requirements for each of these types of infringement at the conclusion of the case.

Another issue you will be asked to decide is whether the [] patent is invalid. A patent may be invalid for a number of reasons, including because it claims subject matter that is not new or is obvious. For a claim to be invalid because it is not new, [alleged infringer] must show, by clear and convincing evidence, that all of the elements of a claim are present in a single previous device or method, or sufficiently described in a single previous printed publication or patent. We call these “prior art.” If a claim is not new, it is said to be anticipated.

Another way that a claim may be invalid is that it may have been obvious. Even though every element of a claim is not shown or sufficiently described in a single piece of “prior art,” the claim may still be invalid if it would have been obvious to a person of ordinary skill in the field of technology of the patent at the relevant time. You will need to consider a number of questions in deciding whether the invention(s) claimed in the [] patent are obvious. I will provide you detailed instructions on these questions at the conclusion of the case.

[Where a written description or enablement defense is presented: A patent may also be invalid if its description in the specification does not meet certain requirements. To be valid, a patent must meet the “written description” requirement. In order to meet this written description requirement, the description of the invention in the specification portion of the patent must be detailed enough to demonstrate that the applicant actually possessed the invention as broadly as claimed in the claims of the issued patent. The disclosure of a patent must also meet the “enablement” requirement. To meet this requirement, the description in the patent has to be sufficiently full and clear to have allowed persons of ordinary skill in the field of technology of

the patent to make and use the invention without undue experimentation, at the time the patent application was originally filed.]

If you decide that any claim of the [] patent has been infringed and is not invalid, you will then need to decide any money damages to be awarded to [patent holder] to compensate it for the infringement. A damages award should put [patent holder] in approximately the same financial position that it would have been in had the infringement not occurred, but in no event may the damages award be less than what [patent holder] would have received had it been paid a reasonable royalty. I will instruct you later on the meaning of a reasonable royalty. The damages you award are meant to compensate [patent holder] and not to punish [alleged infringer]. You may not include in your award any additional amount as a fine or penalty, above what is necessary to compensate [patent holder] for the infringement, in order to punish [alleged infringer]. I will give you more detailed instructions on the calculation of damages at the conclusion of the case.

A.5 Preliminary Instructions

OUTLINE OF TRIAL

The trial will now begin. First, each side may make an opening statement. An opening statement is not evidence. It is simply an opportunity for the lawyers to explain what they expect the evidence will show.

There are two standards of proof that you will apply to the evidence, depending on the issue you are deciding. On some issues, you must decide whether certain facts have been proven by a preponderance of the evidence. A preponderance of the evidence means that the fact that is to be proven is more likely true than not, i.e., that the evidence in favor of that fact being true is sufficient to tip the scale, even if slightly, in its favor. On other issues that I will identify for you, you must use a higher standard and decide whether the fact has been proven by clear and convincing evidence, i.e., that you have been left with a clear conviction that the fact has been proven.

These standards are different from what you may have heard about in criminal proceedings where a fact must be proven beyond a reasonable doubt. On a scale of these various standards of proof, as you move from preponderance of the evidence, where the proof need only be sufficient to tip the scale in favor of the party proving the fact, to beyond a reasonable doubt, where the fact must be proven to a very high degree of certainty, you may think of clear and convincing evidence as being between the two standards.

After the opening statements, [patent holder] will present its evidence in support of its contention that [some of the] [the] claims of the [] patent have been [and continue to be] infringed by [alleged infringer] [and that the infringement has been [and continues to be] willful]. To prove infringement of any claim, [patent holder] must persuade you that it is more likely than not that [alleged infringer] has infringed that claim. [To persuade you that any infringement was willful, [patent holder] must prove that the infringement was willful by clear and convincing evidence.]

[Alleged infringer] will then present its evidence that the claims of the [] patent are invalid [and/or unenforceable]. To prove invalidity [and/or unenforceability] of any claim, [alleged infringer] must persuade you by clear and convincing evidence that the claim is invalid [and/or unenforceable]. In addition to presenting its evidence of invalidity [and/or unenforceability], [alleged infringer] will put on evidence responding to [patent holder]'s proof of infringement [and willfulness].

[Patent holder] may then put on additional evidence responding to [alleged infringer]'s evidence that the claims of the [] patent are invalid [and/or unenforceable], and to offer any additional evidence of infringement [and willfulness]. This is referred to as “rebuttal” evidence. [Patent holder]'s “rebuttal” evidence may respond to any evidence offered by [alleged infringer].

Finally, [alleged infringer] may have the option to put on its “rebuttal” evidence to support its contentions as to the validity [and/or enforceability] of [some of the] [the] claims of the [] patent by responding to any evidence offered by [patent holder] on that issue.

Appendix E: Model Patent Jury Instructions

[During the presentation of the evidence, the attorneys will be allowed brief opportunities to explain what they believe the evidence has shown or what they believe upcoming evidence will show. The attorneys' comments are not evidence and the attorneys are being allowed to comment solely for the purpose of helping you to understand the evidence.]

After the evidence has been presented, [the attorneys will make closing arguments and I will give you final instructions on the law that applies to the case] [I will give you final instructions on the law that applies to the case and the attorneys will make closing arguments]. These closing arguments by the attorneys are not evidence. After the closing arguments and instructions, you will then decide the case.

Instructions at the Close of Evidence

B.1 Summary of Contentions

SUMMARY OF CONTENTIONS

As I did at the start of the case, I will first give you a summary of each side's contentions in this case. I will then provide you with detailed instructions on what each side must prove to win on each of its contentions.

As I previously told you, [patent holder] seeks money damages from [alleged infringer] for allegedly infringing the [] patent by [making], [importing], [using], [selling], and [offering for sale] [products] [methods] that [patent holder] argues are covered by claims [] of the [] patent. These are the asserted claims of the [] patent. [Patent holder] also argues that [alleged infringer] has [actively induced infringement of these claims of the [] patent by others] [contributed to the infringement of these claims of the [] patent by others]. The [products] [methods] that are alleged to infringe are [list of accused products or methods].

[Alleged infringer] denies that it has infringed the asserted claims of the [] patent [and argues that, in addition, claims [] are invalid.] [Add other defenses if applicable.]

Your job is to decide whether [alleged infringer] has infringed the asserted claims of the [] patent and whether any of the asserted claims of the [] patent are invalid. If you decide that any claim of the [] patent has been infringed and is not invalid, you will then need to decide any money damages to be awarded to [patent holder] to compensate it for the infringement. [You will also need to make a finding as to whether the infringement was willful. If you decide that any infringement was willful, that decision should not affect any damages award you make. I will take willfulness into account later.]

B.2 Claim Construction

2.1 THE ROLE OF THE CLAIMS OF A PATENT

Before you can decide many of the issues in this case, you will need to understand the role of patent “claims.” The patent claims are the numbered sentences at the end of each patent. The claims are important because it is the words of the claims that define what a patent covers. The figures and text in the rest of the patent provide a description and/or examples of the invention and provide a context for the claims, but it is the claims that define the breadth of the patent’s coverage. Each claim is effectively treated as if it were a separate patent, and each claim may cover more or less than another claim. Therefore, what a patent covers depends, in turn, on what each of its claims covers.

You will first need to understand what each claim covers in order to decide whether or not there is infringement of the claim and to decide whether or not the claim is invalid. The law says that it is my role to define the terms of the claims and it is your role to apply my definitions to the issues that you are asked to decide in this case. Therefore, as I explained to you at the start of the case, I have determined the meaning of the claims and I will provide to you my definitions of certain claim terms. You must accept my definitions of these words in the claims as being correct. It is your job to take these definitions and apply them to the issues that you are deciding, including the issues of infringement and validity.

B.2 Claim Construction

2.2 HOW A CLAIM DEFINES WHAT IT COVERS

I will now explain how a claim defines what it covers.

A claim sets forth, in words, a set of requirements. Each claim sets forth its requirements in a single sentence. If a device or a method satisfies each of these requirements, then it is covered by the claim.

There can be several claims in a patent. Each claim may be narrower or broader than another claim by setting forth more or fewer requirements. The coverage of a patent is assessed claim-by-claim. In patent law, the requirements of a claim are often referred to as “claim elements” or “claim limitations.” When a thing (such as a product or a process) meets all of the requirements of a claim, the claim is said to “cover” that thing, and that thing is said to “fall” within the scope of that claim. In other words, a claim covers a product or process where each of the claim elements or limitations is present in that product or process.

Sometimes the words in a patent claim are difficult to understand, and therefore it is difficult to understand what requirements these words impose. It is my job to explain to you the meaning of the words in the claims and the requirements these words impose.

As I just instructed you, there are certain specific terms that I have defined and you are to apply the definitions that I provide to you.

By understanding the meaning of the words in a claim and by understanding that the words in a claim set forth the requirements that a product or process must meet in order to be covered by that claim, you will be able to understand the scope of coverage for each claim. Once you understand what each claim covers, then you are prepared to decide the issues that you will be asked to decide, such as infringement and invalidity.

Authorities

For “comprising,” *see, e.g., Cook Biotech Inc. v. ACell, Inc.*, 460 F.3d 1365, 1373-78 (Fed. Cir. 2006); *Invitrogen Corp. v. Biocrest Mfg., L.P.*, 327 F.3d 1364, 1368 (Fed. Cir. 2003) (“The transition ‘comprising’ in a method claim . . . is open-ended and allows for additional steps.”); for “consisting of,” *see, e.g., Conoco, Inc. v. Energy & Env’tl. Int’l, L.C.*, 460 F.3d 1349, 1358-61 (Fed. Cir. 2006); *Vehicular Techs. Corp. v. Titan Wheel Int’l, Inc.*, 212 F.3d 1377, 1383 (Fed. Cir. 2000) (“In simple terms, a drafter uses the phrase ‘consisting of’ to mean ‘I claim what follows and nothing else.’”); for “consisting essentially of,” *see, e.g., CIAS, Inc. v. Alliance Gaming Corp.*, 504 F.3d 1356, 1361 (Fed. Cir. 2007); *AK Steel Corp. v. Sollac & Ugine*, 344 F.3d 1234, 1239 (Fed. Cir. 2003) (“consisting essentially of” is a middle ground between open-ended term “comprising” and closed-ended phrase “consisting of”).

B.2 Claim Construction

2.2a INDEPENDENT AND DEPENDENT CLAIMS

[This instruction should only be given where both dependent and independent claims are at issue.]

This case involves two types of patent claims: independent claims and dependent claims.

An “independent claim” sets forth all of the requirements that must be met in order to be covered by that claim. Thus, it is not necessary to look at any other claim to determine what an independent claim covers. In this case, claim(s) [] of the [] patent are each independent claims.

The remainder of the claims in the [] patent are “dependent claims.” A dependent claim does not itself recite all of the requirements of the claim but refers to another claim for some of its requirements. In this way, the claim “depends” on another claim. A dependent claim incorporates all of the requirements of the claim(s) to which it refers. The dependent claim then adds its own additional requirements. To determine what a dependent claim covers, it is necessary to look at both the dependent claim and any other claim(s) to which it refers. A product [or process] that meets all of the requirements of both the dependent claim and the claim(s) to which it refers is covered by that dependent claim.

[Note: It may be helpful to submit to the jury a chart setting forth all dependencies for each dependent claim.]

B.2 Claim Construction

2.3 CLAIM INTERPRETATION

I will now explain to you the meaning of some of the words of the claims in this case. In doing so, I will explain some of the requirements of the claims. As I have previously instructed you, you must accept my definition of these words in the claims as correct. For any words in the claim for which I have not provided you with a definition, you should apply their common meaning. You should not take my definition of the language of the claims as an indication that I have a view regarding how you should decide the issues that you are being asked to decide, such as infringement and invalidity. These issues are yours to decide.

[Court gives its claim interpretation. This instruction may be divided up into claim-by-claim sub-instructions if the Court believes it would be helpful.]

Authorities

Markman v. Westview Instruments, Inc., 517 U.S. 370 (1996) (claim construction of a patent, including claim terms, is exclusively within the province of the court); *O2 Micro Int'l Ltd. v. Beyond Innovation Tech. Co.*, 521 F.3d 1351, 1360-63 (Fed. Cir. 2008) (remanding to the district court to determine the construction of “only if” when the “ordinary” meaning did not resolve the parties’ dispute); *Phillips v. AWH Corp.*, 415 F.3d 1303, 1312-13 (Fed. Cir. 2005) (en banc) (“ordinary and customary meaning” is based on the understanding of a person of ordinary skill in the art in question at the time of the invention); *Pitney Bowes, Inc. v. Hewlett-Packard Co.*, 182 F.3d 1298, 1304 (Fed. Cir. 1999) (claim construction is a question of law reviewed de novo); *Cybor Corp. v. FAS Techs.*, 138 F.3d 1448, 1456 (Fed. Cir. 1998) (same); *Markman v. Westview Instruments, Inc.*, 52 F.3d 967, 977 (Fed. Cir. 1995) (in jury cases, court has obligation to construe claim terms).

B.2 Claim Construction

2.3a SECTION 112, PARAGRAPH 6

[This instruction should only be given where the asserted claims include means-plus-function or step-plus-function requirements.]

Where claims include means-plus-function requirements:

Claim [] uses the phrase “means for [function].” This “means for” phrase has a special meaning in patent law. It is called a “means-plus-function” requirement. It does not cover all of the structures that could perform the function set forth in the claim, namely, “[function].” Instead, it covers a structure or a set of structures that performs that function and that is either identical or “equivalent” to [at least one of] the [set(s) of] structure(s) described in the [] patent for performing that function. The issue of whether two structures are identical or equivalent is for you to decide. I will explain to you later how to determine whether two structures or two sets of structures are “equivalent” to one another. For purposes of this case, I have identified the [set(s) of] structure(s) described in the [] patent that perform(s) the function of “[function].” [Claims [] also include similar means-plus-function requirements.] When I read you my definitions for certain claim terms a few moments ago, I identified the structures described in the [] patent for performing the relevant functions. You should apply my definition of the function and the structures described in the [] patent for performing it as you would apply my definition of any other claim term.

Where claims include step-plus-function requirements:

Claim [] uses the phrase “step for [function].” It does not cover all of the acts that could perform the function set forth in the claim. Instead, it covers acts that perform that function and are either identical or “equivalent” to [at least one of] the [set(s) of] act(s) described in the [] patent for performing that function. The issue of whether two structures are identical or equivalent is for you to decide. I will explain to you later how to determine whether two acts or two sets of acts are “equivalent” to one another. For purposes of this case, I have identified the [set(s) of] act(s) described in the [] patent that perform(s) the function of “[function].” [Claims [] also include similar step-plus-function requirements.] When I read you my definitions for certain claim terms a few moments ago, I identified the acts described in the [] patent for performing the relevant functions. You should apply my definition of the function and the acts described in the [] patent for performing it as you would apply my definition of any other claim term.

Authorities

35 U.S.C. § 112, ¶ 6; *Allvoice Computing PLC v. Nuance Commc'ns, Inc.*, 504 F.3d 1236, 1240-41 (Fed. Cir. 2007); *Applied Med. Res. Corp. v. U.S. Surgical Corp.*, 448 F.3d 1324, 1332-34 (Fed. Cir. 2006) (explaining that an object meeting a means-plus-function limitation with two functions must perform both claimed functions and be an equivalent structure. Equivalence of structure can be shown here if the objects perform both identical functions in substantially the same way to achieve substantially the same result.); *Al-Site Corp. v. VSI Int'l Inc.*, 174 F.3d 1308, 1318-21 (Fed. Cir. 1999) (distinguishing between means- or step-plus-function to

equivalents available at time of issuance and application of doctrine of equivalents to after-arising inventions); *WMS Gaming Inc. v. Int'l Game Tech.*, 184 F.3d 1339, 1351 (Fed. Cir. 1999) (“The proper test for determining whether the structure in an accused device is equivalent to the structure recited in a section 112, ¶ 6, claim is whether the differences between the structure in the accused device and any disclosed in the specification are insubstantial.”); *Odetics, Inc. v. Storage Tech. Corp.*, 185 F.3d 1259, 1266-67 (Fed. Cir. 1999); *Chiuminatta Concrete Concepts, Inc. v. Cardinal Indus., Inc.*, 145 F.3d 1303, 1307-08 (Fed. Cir. 1998).

B.3 Infringement

3.1 INFRINGEMENT GENERALLY

I will now instruct you how to decide whether or not [alleged infringer] has infringed the [] patent. Infringement is assessed on a claim-by-claim basis. Therefore, there may be infringement as to one claim but no infringement as to another.

In this case, there are five possible ways that a claim may be infringed. The five types of infringement are called: (1) direct infringement; (2) active inducement; (3) contributory infringement; (4) infringement through the supply of components from the United States to another country; and (5) infringement through importation of a product made abroad by a patented process. Active inducement and contributory infringement are referred to as indirect infringement. There cannot be indirect infringement without someone else engaging in direct infringement. To prove indirect infringement, [patent holder] must also prove that [alleged infringer]'s indirect infringement caused direct infringement.

In this case, [patent holder] has alleged that [alleged infringer] directly infringes the [] patent. [[In addition,] [patent holder] has alleged that [alleged direct infringer] directly infringes the [] patent, and [alleged infringer] is liable for [actively inducing or contributing to] that direct infringement by [alleged direct infringer]. [Patent holder] has also alleged that [alleged infringer] is liable for [infringement through the supply of components from the United States for combination outside of the United States] [and/or] [infringement through importation into the United States of a product made by the patented process].]

In order to prove infringement, [patent holder] must prove that the requirements for one or more of these types of infringement are met by a preponderance of the evidence, i.e., that it is more likely than not that all of the requirements of one or more of each of these types of infringement have been proved.

I will now explain each of these types of infringement in more detail.

Authorities

Warner-Lambert Co. v. Teva Pharms. USA, Inc., 418 F.3d 1326, 1341 n.15 (Fed. Cir. 2005) (infringement must be proven by a preponderance of the evidence); *Seal-Flex, Inc. v. Athletic Track & Court Constr.*, 172 F.3d 836, 842 (Fed. Cir. 1999) (a patentee must “prove that the accused product or process contains, either literally or under the doctrine of equivalents, every limitation of the properly construed claim”); *Morton Int’l, Inc. v. Cardinal Chem. Co.*, 5 F.3d 1464, 1468-69 (Fed. Cir. 1993) (upholding lower court’s finding of noninfringement based on plaintiff’s failure to prove that the accused product met all of the claimed requirements).

B.3 Infringement

3.1a DIRECT INFRINGEMENT BY “LITERAL INFRINGEMENT”

There are two types of “direct infringement”: (1) “literal infringement” and (2) “infringement under the doctrine of equivalents.” In order to prove direct infringement by literal infringement, [patent holder] must prove by a preponderance of the evidence, i.e., that it is more likely than not, that [alleged infringer] made, used, sold, offered for sale within, or imported into the United States a [product or process] that meets all of the requirements of a claim and did so without the permission of [patent holder] during the time the [] patent was in force. You must compare the [product or process] with each and every one of the requirements of a claim to determine whether all of the requirements of that claim are met.

You must determine, separately for each asserted claim, whether or not there is infringement. There is one exception to this rule. If you find that a claim on which other claims depend is not infringed, there cannot be infringement of any dependent claim that refers directly or indirectly to that independent claim. On the other hand, if you find that an independent claim has been infringed, you must still decide, separately, whether the [product or process] meets additional requirements of any claims that depend from the independent claim, thus, whether those claims have also been infringed. A dependent claim includes all the requirements of any of the claims to which it refers plus additional requirements of its own.

Authorities

Kim v. ConAgra Foods, Inc., 465 F.3d 1312, 1316, n.1 (Fed. Cir. 2006) (dependent claims not infringed when independent claim not infringed); *MicroStrategy Inc. v. Bus. Objects, S.A.*, 429 F.3d 1344, 1352-53 (Fed. Cir. 2005) (no literal infringement where accused product did not contain every element of the claim); *Cross Med. Prods. v. Medtronic Sofamor Danek*, 424 F.3d 1293, 1309-11 (Fed. Cir. 2005) (no direct infringement where accused product did not include each claim limitation); *Netword, LLC v. Centraal Corp.*, 242 F.3d 1347, 1353-54 (Fed. Cir. 2001) (no literal infringement where all of the elements of the claim not present in the accused system); *Moleculon Research Corp. v. CBS, Inc.*, 793 F.2d 1261 (Fed. Cir. 1986) (affirming finding of direct infringement based on circumstantial evidence).

B.3 Infringement

3.1b DIRECT INFRINGEMENT BY “LITERAL INFRINGEMENT” OF SECTION 112, PARAGRAPH 6 CLAIM REQUIREMENTS

[This instruction should only be given where the asserted claims include means-plus-function or step-plus-function requirements.]

Where claims include means/step-plus-function requirements:

As I have previously explained, claims [] include requirements that are in [means/step-plus-function] form.

A product or a process meets a means/step-plus-function requirement of a claim if: (1) it has [a structure or a set of structures/an action or a set of actions] that perform(s) the identical function recited in the claim, and (2) that [structure or set of structures/action or set of actions] is either identical or “equivalent” to [one or more of] the described [set(s) of] [structure(s)/ action(s)] that I defined earlier as performing the function of [functional limitation]. If the [product] does not perform the specific function recited in the claim, the “means-plus-function” requirement is not met, and the [product] does not literally infringe the claim. Alternatively, even if the [product] has [a structure or a set of structures] that performs the function recited in the claim but the [structure or set of structures] is not either identical or “equivalent” to [one or more of] the [set(s) of] [structure(s)/action(s)] that I defined to you as being described in the [] patent and performing this function, the [product] does not literally infringe the asserted claim.

[A structure or a set of structures/An action or a set of actions] may be found to be “equivalent” to [one of] [the/a] [set(s) of] [structure(s)/action(s)] I have defined as being described in the [] patent if a person having ordinary skill in the field of technology of the [] patent either would have considered the differences between them to be insubstantial at the time the [] patent issued or if that person would have found the [structure(s)/actions(s)] performed the function in substantially the same way to accomplish substantially the same result. In deciding whether the differences would be “insubstantial,” you may consider whether a person having an ordinary level of skill in the field of technology of the patent would have known of the interchangeability of the two structures or sets of structures. Interchangeability itself is not sufficient; in order for the structures to be considered to be interchangeable, the interchangeability of the two structures must have been known to persons of ordinary skill in that art at the time the patent issued. The fact that [a structure or a set of structures/an act or a set of acts] is known now and is “equivalent” is not enough. The [structure or set of structures/act or set of acts] must also have been available at the time the [] patent issued.

[In this case, the parties have agreed that the relevant field of technology is [field of technology] and that a person having an ordinary level of skill would [qualifications].] [In this case, you will have to decide [issues regarding field of technology and level of ordinary skill in the art]. I will instruct you later how to decide this.]

In order to prove direct infringement by literal infringement of a means-plus/step-plus-function limitation, [patent holder] must prove the above requirements are met by a preponderance of the evidence.

Authorities

35 U.S.C. § 112, ¶ 6; *Allvoice Computing PLC v. Nuance Commc 'ns, Inc.*, 504 F.3d 1236, 1240-41 (Fed. Cir. 2007); *Cross Med. Prods., Inc. v. Medtronic Sofamor Danek, Inc.*, 424 F.3d 1293, 1315-17 (Fed. Cir. 2005); *Applied Med. Res. Corp. v. U.S. Surgical Corp.*, 448 F.3d 1324, 1333-34 (Fed. Cir. 2006); *Omega Eng'g, Inc. v. Raytek Corp.*, 334 F.3d 1314, 1328 (Fed. Cir. 2003) (holding that the structure in an accused device meets a § 112, ¶ 6, limitation if the structure performs the identical function recited in the claim and is identical or equivalent to the structure in the specification corresponding to that limitation); *Al-Site Corp. v. VSI Int'l Inc.*, 174 F.3d 1308, 1320 (Fed. Cir. 1999) (holding that an equivalent structure or act under § 112 cannot embrace technology developed after the patent issued because the literal meaning of a claim is fixed upon issuance); *WMS Gaming, Inc. v. Int'l Game Tech.*, 184 F.3d 1339, 1350 (Fed. Cir. 1999); *Odetics, Inc. v. Storage Tech. Corp.*, 185 F.3d 1259, 1266-68 (Fed. Cir. 1999); *Chiuminatta Concrete Concepts, Inc. v. Cardinal Indus., Inc.*, 145 F.3d 1303, 1307-11 (Fed. Cir. 1998); *Micro Chem., Inc. v. Great Plains Chem. Co.*, 103 F.3d 1538, 1547 (Fed. Cir. 1997); *Valmont Indus., Inc. v. Reinke Mfg. Co.*, 983 F.2d 1039, 1042 (Fed. Cir. 1993).

B.3 Infringement

3.1c DIRECT INFRINGEMENT UNDER THE DOCTRINE OF EQUIVALENTS

[This instruction should only be given where the patentee asserts infringement under the doctrine of equivalents.]

If a [person] [company] makes, uses, sells, offers to sell within, or imports into the United States a [product] [process] that does not meet all of the requirements of a claim and thus does not literally infringe that claim, there can still be direct infringement if that [product or process] satisfies that claim “under the doctrine of equivalents.”

Under the doctrine of equivalents, a [product or process] infringes a claim if the accused [product or process] [contains elements or performs steps] corresponding to each and every requirement of the claim that is equivalent to, even though not literally met by, the accused [product or process]. You may find that an element or step is equivalent to a requirement of a claim that is not met literally if a person having ordinary skill in the field of technology of the patent would have considered the differences between them to be “insubstantial” or would have found that the [structure or action]: (1) performs substantially the same function and (2) works in substantially the same way (3) to achieve substantially the same result as the requirement of the claim. In order for the [structure or action] to be considered interchangeable, the [structure or action] must have been known at the time of the alleged infringement to a person having ordinary skill in the field of technology of the patent. Interchangeability at the present time is not sufficient. In order to prove infringement by “equivalents,” [patent holder] must prove the equivalency of the [structure or actions] to a claim element by a preponderance of the evidence.

If claims with means-plus-function clauses are at issue:

When the claim requirement that is not met by the [product or process] is a [“means-plus-function” or “step-plus-function”] requirement, and if you determined that there is no “literal infringement” because there is no [structure or set of structures/action or set of actions] in the [product or process] that performs the specific function of the means-plus-function requirement,, you may decide that the [structure or action] nonetheless corresponds to the requirements of the claim under the doctrine of equivalents if it performs an “equivalent” function and has an “equivalent” [structure or action].

On the other hand, if you find that the accused [product or process] has no corresponding [structure or set of structures/action or set of actions] to [any of] the [set(s) of] [structure(s) or action(s)] that I defined as performing that function, then you must find that there is no infringement under the doctrine of equivalents. This is the case even if you find that the accused [product or process] has some other [structure or set of structures/action or set of actions] that performs the specific function of the means-plus-function requirement. In other words, for a means-plus-function requirement, a determination that there is no “equivalent” structure for purposes of “literal infringement” precludes you from finding infringement under the “doctrine of equivalents.”

Authorities

Festo Corp. v. Shoketsu Kinzoku Kogyo Kabushiki Co., 535 U.S. 722 (2002); *Warner-Jenkinson Co. v. Hilton Davis Chem. Co.*, 520 U.S. 17 (1997); *Graver Tank & Mfg. Co. v. Linde Air Prods. Co.*, 339 U.S. 605, 609 (1950) (explaining what constitutes an “equivalent”); *Interactive Pictures Corp. v. Infinite Pictures Inc.*, 274 F.3d 1371, 1381-82 (Fed. Cir. 2001); *Johnson & Johnston Assocs. v. R.E. Serv. Co.*, 285 F.3d 1046 (Fed. Cir. 2002) (no infringement under the doctrine of equivalents); *Al-Site Corp. v. VSI Int’l, Inc.*, 174 F.3d 1308, 1320 (Fed. Cir. 1999) (distinguishing between the doctrine of equivalents and the statutory term “equivalents”); *Hughes Aircraft Co. v. United States*, 140 F.3d 1470, 1475 (Fed. Cir. 1998); *Multiform Desiccants, Inc. v. Medzam, Ltd.*, 133 F.3d 1473, 1480 (Fed. Cir. 1998); *Dolly, Inc. v. Spalding & Evenflo Cos.*, 16 F.3d 394, 397 (Fed. Cir. 1994).

B.3 Infringement

3.1d LIMITATIONS ON DIRECT INFRINGEMENT UNDER THE DOCTRINE OF EQUIVALENTS

[Although the applicability of these limitations is ultimately decided by the Court, this instruction is provided for the case in which the Court decides to submit these issues to the jury for advisory findings.]

[If there is a question as to whether the prior art limits the doctrine of equivalents:

The prior art may preclude a finding of infringement under the doctrine of equivalents. I will explain what “prior art” is, but, generally speaking, “prior art” is things that were already known or done before the invention. In reaching your decisions in this case, you must use the definition of “prior art” that I provide to you.]

[Statement of the law not using “hypothetical claim”:

To determine whether the prior art precludes a finding of infringement under the doctrine of equivalents for a particular [product or process] that is accused of infringing a particular claim, you must determine what [products or processes] are in the “prior art” as well as what [products or processes] would have been obvious from the “prior art” to a person having an ordinary level of skill in the field of technology of the patent at the time of the invention.

If [alleged infringer] establishes that a [product or process] that (1) meets the same claim requirements as the [product or process] that is accused of infringing and (2) has the same allegedly “equivalent” alternative feature(s) as the [product or process] that is accused of infringing is in the prior art or would have been obvious from the prior art to a person having ordinary skill in the field of technology of the invention at the time of the invention, you must find that the claim has not been infringed.

[Alleged infringer] has the burden of proving that this hypothetical, equivalent claim was within the prior art at the time of the alleged infringement, by a preponderance of the evidence.]

[Alternative statement of the law using “hypothetical claim”:

To determine whether the prior art precludes a finding of infringement under the doctrine of equivalents, you must first have in mind a “hypothetical claim” that would cover the accused, allegedly equivalent [product or process] literally. The hypothetical claim is exactly the same as the claim at issue, except that the unmet claim requirements are broadened so that they would be met by the allegedly “equivalent” hypothetical claim.

Once you have this equivalent “hypothetical claim” in mind, you must decide whether this hypothetical claim would have been invalid for either anticipation or obviousness. I will instruct you later on how to determine if a claim is invalid for anticipation or obviousness. You should use these same rules to determine whether or not the “hypothetical claim” would be invalid for anticipation or obviousness. If you determine that the “hypothetical claim” would have been

invalid for anticipation or obviousness, then you must find that there is no infringement of this particular claim under the doctrine of equivalents.]

[If there is a question as to whether a disclosure in the patent precludes equivalence:

You may not find that a [product or process] infringes a claim under the doctrine of equivalents if you find that: (1) the allegedly “equivalent” alternative feature(s) of that [product or process] was/were described somewhere in the patent and (2) that [product or process] is not covered literally by any of the claims of the patent.]

[If there is a question as to argument-based prosecution history estoppel:

You may not find that a [product or process] infringes a claim under the doctrine of equivalents if you find that, during the patent application process, the applicant for the patent distinguished an unmet requirement from the allegedly “equivalent” alternative aspect of that [product or process].]

[If there is a question as to amendment-based prosecution history estoppel:

[Alleged infringer] has argued that [patent holder] cannot assert infringement under the doctrine of equivalents due to statements [patent holder] made to the PTO in order to get the claim allowed in the first place. In order to find [accused product] to be equivalent, you must also make certain findings regarding the statements [patent holder] made to the PTO in order to get the [] patent. Specifically, in order to find equivalents, you must first also find one or more of the following: (1) the amendment that is asserted by [alleged infringer] to limit the scope of equivalents substituted a broader requirement for a narrower requirement or replaced a requirement of equal scope; (2) the reason for making this amendment was not related to patentability; (3) a person having ordinary skill in the field of technology of the patent at the time of the amendment would not have foreseen the potential substitution of the allegedly “equivalent” alternative for the unmet claim requirement; (4) the reason for the amendment is tangential or relates to some issue other than the assertion of equivalence at issue; or (5) some other reason, such as the shortcomings of language, prevented the applicant from using claim language that included the allegedly “equivalent” alternative. You may not find that the alternative feature of the [accused product or process] is an equivalent to an unmet requirement of a claim if that requirement was added to the claim (or to any claim of the [] patent) by amendment during the prosecution of the applications that led to issuance of the [] patent, unless you also find that at least one of these factors that I have identified to you.]

[If there is a question as to vitiation:

You may not determine that an alternative aspect of a [product or process] is equivalent to an unmet requirement of a claim if a finding of infringement under the doctrine of equivalents would effectively eliminate that requirement. Specifically, the alleged equivalent cannot eliminate or ignore an element or requirement of the claim.]

Authorities

Honeywell Int'l v. Hamilton Sundstrand Corp., 370 F.3d 1131 (Fed. Cir. 2004); *Festo Corp. v. Shoketsu Kinzoku Kogyo Kabushiki Co.*, 344 F.3d 1359 (Fed. Cir. 2003) (en banc); *Interactive Pictures Corp. v. Infinite Pictures, Inc.*, 274 F.3d 1371, 1380 (Fed. Cir. 2001); *Al-Site Corp. v. VSI Int'l, Inc.*, 174 F.3d 1308, 1320 (Fed. Cir. 1999); *Wilson Sporting Goods Co. v. David Geoffrey & Assocs.*, 904 F.2d 676, 684 (Fed. Cir. 1990).

B.3 Infringement

3.2 INDIRECT INFRINGEMENT—ACTIVE INDUCEMENT

[Patent holder] alleges that [alleged infringer] is liable for infringement by actively inducing [someone else] [some other company] to directly infringe the [] patent literally or under the doctrine of equivalents. As with direct infringement, you must determine whether there has been active inducement on a claim-by-claim basis.

[Alleged infringer] is liable for active inducement of a claim only if [patent holder] proves by a preponderance of the evidence:

- (1) that the acts are actually carried out by [insert name or other description of alleged direct infringer] and directly infringe that claim;
- (2) that [alleged infringer] took action during the time the [] patent was in force intending to cause the infringing acts by [insert name or other description of alleged direct infringer]; and
- (3) that [alleged infringer] was aware of the [] patent and knew that the acts, if taken, would constitute infringement of that patent.

[addition to the end of (3) above when willful blindness concerning the [] patent's existence is at issue:]

or that [alleged infringer] believed there was a high probability that the acts by [insert name or other description of alleged direct infringer] would infringe a patent [by patent holder] and [alleged infringer] took deliberate steps to avoid learning of that infringement.

[alternative addition to the end of (3) above when knowledge of the patent is undisputed but willful blindness concerning infringement of that patent is at issue:]

or that [alleged infringer] believed there was a high probability that the acts by [insert name or other description of alleged direct infringer] infringed the [] patent and took deliberate steps to avoid learning of that infringement.

If you find that [alleged infringer] was aware of the patent, but believed that the acts it encouraged did not infringe that patent, [alleged infringer] cannot be liable for inducement.

In order to establish active inducement of infringement, it is not sufficient that [insert name or other description of alleged direct infringer] itself directly infringes the claim. Nor is it sufficient that [alleged infringer] was aware of the act(s) by [insert name or other description of alleged direct infringer] that allegedly constitute the direct infringement. Rather, in order to find active inducement of infringement, you must find either that [accused infringer] specifically intended [insert name or other description of alleged direct infringer] to infringe the [] patent or that [accused infringer] believed there was a high probability that [insert name or other description of alleged direct infringer] would infringe the [] patent, but deliberately avoided learning the

infringing nature of [insert name or other description of alleged direct infringer]’s acts. The mere fact, if true, that [alleged infringer] knew or should have known that there was a substantial risk that [insert name or description of alleged direct infringer]’s acts would infringe the [] patent would not be sufficient for active inducement of infringement.

Authorities

35 U.S.C. § 271(b); *Commil USA, LLC v. Cisco Sys.*, ___ U.S. ___, ___; 135 S. Ct. 1920, ___ (U.S. 2015); *Global-Tech Appliances, Inc. v. SEB S. A.*, 563 U.S. 754, ___; 131 S.Ct. 2060, 2068-2071; 179 L.Ed. 1167, 1177-1180 (2012); *Muniauction Inc. v. Thomson Corp.*, 532 F.3d 1318, 1329-30 (Fed. Cir. 2008); *Lucent Technologies, Inc. v. Gateway, Inc.*, 580 F.3d 1301, 1340 (Fed. Cir. 2009); *DSU Med. Corp. v. JMS Co.*, 471 F.3d 1293, 1306 (Fed. Cir. 2006) (“[I]nducement requires that the alleged infringer knowingly induced infringement and possessed specific intent to encourage another’s infringement.”) (citation and internal quotation marks omitted); *MGM Studios Inc. v. Grokster*, 419 F.3d 1005 (Fed. Cir. 2005); *Insituform Techs., Inc. v. CAT Contracting, Inc.*, 385 F.3d 1360, 1377-78 (Fed. Cir. 2004) (inducer must have actual or constructive knowledge of the patent); *Ferguson Beauregard/Logic Controls, Div. of Dover Res., Inc. v. Mega Sys., LLC*, 350 F.3d 1327, 1342 (Fed. Cir. 2003) (no inducement where evidence did not show defendant knew or should have known that his actions were encouraging infringement); *Warner-Lambert Co. v. Apotex Corp.*, 316 F.3d 1348, 1363-66 (Fed. Cir. 2003) (no infringement where lack of intent to induce).

Committee Comments: The underlined language in the instruction incorporates the “willful blindness” standard addressed by the Supreme Court in *Global-Tech Appliances, Inc. v. SEB S. A.*, 563 U.S. 754, ___; 131 S.Ct. 2060, 2068-2071 (2012). The Committee is of the opinion that in cases where willful blindness is not an issue, the underlined language should be omitted to reduce the possibility of juror confusion.

An earlier version of this instruction included a belief in invalidity as a ground for finding no induced infringement. That instruction was based on *Commil USA, LLC v. Cisco Sys.*, 720 F.3d 1361 (Fed. Cir. 2013), in which a divided panel of the Federal Circuit held that an accused infringer’s “evidence of a good-faith belief of invalidity may negate the requisite intent for induced infringement.”

In June of 2015, however, the Supreme Court reversed, holding that “a belief as to invalidity cannot negate the scienter required for induced infringement.” *Commil USA, LLC v. Cisco Sys.*, ___ U.S. ___, ___; 135 S. Ct. 1920, ___ (U.S. 2015).

B.3 Infringement

3.3 INDIRECT INFRINGEMENT—CONTRIBUTORY INFRINGEMENT

[Patent holder] argues that [alleged infringer] is liable for contributory infringement by contributing to the direct infringement of the [] patent by [insert name or other description of direct infringer]. As with direct infringement, you must determine contributory infringement on a claim-by-claim basis.

[Alleged infringer] is liable for contributory infringement of a claim if [patent holder] proves by a preponderance of the evidence:

- (1) [alleged infringer] sells, offers to sell, or imports within the United States a component of a product, or apparatus for use in a process, during the time the [] patent is in force;
- (2) the component or apparatus has no substantial, noninfringing use;
- (3) the component or apparatus constitutes a material part of the invention;
- (4) [alleged infringer] is aware of the [] patent and knows that the [products or processes] for which the [component or apparatus] has no other substantial use may be covered by a claim of the [] patent or may satisfy a claim of the [] patent under the doctrine of equivalents; and
- (5) that use directly infringes the claim.

In order to prove contributory infringement, [patent holder] must prove that each of the above requirements is met. This proof of each requirement must be by a preponderance of the evidence, i.e., that it is more likely than not that each of the above requirements is met.

Authorities

35 U.S.C. § 271(c) (“not a staple article”); *Aro Mfg. Co. v. Convertible Top Replacement Co.*, 377 U.S. 476 (1964) (knowledge of plaintiff’s patent and that the part supplied is significant); *Ricoh Co. v. Quanta Computer Inc.*, 550 F.3d 1325, 1327 (Fed. Cir. 2008), *cert denied*, 129 S. Ct. 2864 (2009); *Alloc, Inc. v. ITC*, 342 F.3d 1361, 1374 (Fed. Cir. 2003) (affirming determination of no contributory infringement); *Mentor H/S, Inc. v. Med. Device Alliance, Inc.*, 244 F.3d 1365 (Fed. Cir. 2001) (reversing district court’s finding of no contributory infringement and inducement); *Hewlett-Packard Co. v. Bausch & Lomb, Inc.*, 909 F.2d 1464, 1469 (Fed. Cir. 1990) (differentiating contributory infringement from inducement); *Preemption Devices, Inc. v. Minn. Mining & Mfg. Co.*, 803 F.2d 1170, 1174 (Fed. Cir. 1986) (direct infringement findings supported contributory infringement findings).

B.3 Infringement

3.4 INFRINGEMENT THROUGH THE SUPPLY OF COMPONENTS FROM UNITED STATES FOR COMBINATION ABROAD

[This instruction should be given if patentee asserts infringement under 35 U.S.C. § 271(f)(1) or § 271(f)(2).]

[If § 271(f)(1)—active inducement—is at issue:

[Alleged infringer] is liable for § 271(f)(1) infringement of a claim (active inducement of foreign combination of components supplied from the United States) if patentee proves by a preponderance of the evidence that:

- (1) [alleged infringer] supplies [or causes to be supplied] components from the United States to a place outside the United States, which make up all or a substantial portion of the invention of any one of the claims of the [] patent;
- (2) [alleged infringer] takes action intentionally to cause another to act by [insert name or other description of alleged direct infringer] outside of the United States to assemble the components;
- (3) [alleged infringer] knows of the [] patent, and knows that the encouraged acts constitute infringement of that patent; and
- (4) the encouraged acts would constitute direct infringement of the claim if they had been carried out in the United States.

If you find that [alleged infringer] was aware of the patent, but believed that the acts it encouraged would not constitute infringement of the patent if carried out in the United States, [alleged infringer] cannot be liable for inducement.

In order to establish active inducement of infringement, it is not sufficient that [insert name or other description of alleged direct infringer] itself allegedly directly infringes the claim. Nor is it sufficient that [alleged infringer] was aware of the act(s) that allegedly constitute the direct infringement. Rather, you must find that [alleged infringer] specifically intended for [insert name or other description of alleged direct infringer] to infringe the [] patent, in order to find inducement of infringement. If you do not find that [alleged infringer] specifically intended to infringe, then you must find that [alleged infringer] has not actively induced the alleged infringement under § 271(f)(1).]

[If § 271(f)(2)—contributory foreign infringement—is at issue:

[Alleged infringer] is [also] liable for § 271(f)(2) infringement of a claim if [patent holder] proves by a preponderance of the evidence that:

- (1) [alleged infringer] supplies a component, or causes a component to be supplied, from the United States to a place outside of the United States;

- (2) the only substantial use for the component is in a product that [product or process] would infringe if the combination had occurred in the United States;
- (3) [alleged infringer] is aware of the [] patent and knows that the [component or apparatus] has no other substantial use and may be covered by a claim of the patent [literally or under the doctrine of equivalents]; and
- (4) intends for the component to be used in a product that would directly infringe the claim if it had been used in the United States.

Authorities

35 U.S.C. § 271(f); *Cardiac Pacemakers, Inc. v. St. Jude Med.*, 576 F.3d 1348, 1365 (Fed. Cir. 2009) (§ 271(f) does not cover method claims); *Microsoft Corp. v. AT&T Corp.*, 550 U.S. 437 (2007); *Liquid Dynamics Corp. v. Vaughan Co.*, 449 F.3d 1209, 1222-23 (Fed. Cir. 2006); *Pellegrini v. Analog Devices, Inc.*, 375 F.3d 1113, 1117-18 (Fed. Cir. 2004); *NTP, Inc. v. Research in Motion, Ltd.*, 418 F.3d 1282, 1366 (Fed. Cir. 2005); *Union Carbide Chems. & Plastics Tech. Corp. v. Shell Oil Co.*, 425 F.3d 1366 (Fed. Cir. 2005); *Waymark Corp. v. Porta Sys., Corp.*, 245 F.3d 1364, 1368 (Fed. Cir. 2001) (“[T]he statutory language in this section [271(f)(2)] does not require an actual combination of the components, but only a showing that the infringer shipped them with the intent that they be combined.”).

Committee Comments: For simplicity’s sake, this instruction does not incorporate the “willful blindness” standard for induced infringement addressed by the Supreme Court in *Global-Tech Appliances, Inc. v. SEB S. A.*, 563 U.S. 754, ___ ; 131 S.Ct. 2060, 2068-2071 (2012). If the patentee is proceeding on a theory of willful blindness, however, that standard should be addressed in this instruction. See Instruction 3.2.

B.3 Infringement

3.5 INFRINGEMENT BY SALE, OFFER FOR SALE, USE, OR IMPORTATION OF A PRODUCT MADE OUTSIDE THE UNITED STATES BY PATENTED PROCESS

[Alleged infringer] is liable for direct infringement of a claim if [patent holder] proves by a preponderance of the evidence that [alleged infringer], without [patent holder]'s authorization, imports, offers to sell, sells, or uses within the United States a product which was made outside of the United States during the time the [] patent is in force by a process that, if performed in the United States, would infringe the claim literally or under the doctrine of equivalents. However, if the product has been materially changed by an additional process or the product has become a trivial and nonessential component of another product, you must find [alleged infringer] did not infringe the [] patent.

Authorities

35 U.S.C. § 271(g); *Bayer AG v. Housey Pharms., Inc.*, 340 F.3d 1367 (Fed. Cir. 2003) (finding infringement under this section); *Ajinomoto Co. v. Archer-Daniels-Midland Co.*, 228 F.3d 1338, 1347 (Fed. Cir. 2000) (same).

B.3 Infringement

3.6 DIRECT INFRINGEMENT: ONE OR MORE SYSTEM COMPONENTS LOCATED OUTSIDE THE UNITED STATES

[This instruction should only be given where one or more components of an accused system are located outside of the United States.]

Direct infringement requires that the accused system include every element recited in the claim.

[Patent holder] claims that infringement occurred within the United States even though some (but not all) of the elements of the claim were located outside of the United States. For infringement to occur within the United States, [patent holder] must prove by a preponderance of the evidence that the control of the system was exercised and the benefit of the system was enjoyed in the United States.

Authorities

35 U.S.C. § 271(a); *NTP, Inc. v. Research in Motion Ltd.*, 418 F.3d 1282, 1313-21 (Fed. Cir. 2005); *id.* 1317 (“The use of a claimed system under section 271(a) is the place at which the system as a whole is put into service, i.e., the place where control of the system is exercised and beneficial use of the system obtained.”).

B.3 Infringement

3.7 DIRECT INFRINGEMENT: ACTS OF MULTIPLE PARTIES MUST BE COMBINED TO MEET ALL CLAIM LIMITATIONS

[This instruction should only be given where the patentee alleges direct infringement by the combined acts of multiple persons or companies.]

Direct infringement occurs where all steps of a claimed method are performed by or are attributable to a single party. Where more than one party is involved in practicing the steps, you must determine whether the acts of one are attributable to the other such that a single party is responsible for the infringement. There are two situations where there may be direct infringement if no single party performs all of the steps of a claimed process but more than one party performs every step of the process: (1) the parties have formed a joint enterprise or (2) one party directs or controls other party's performance of the claim steps.

[Patent holder] alleges that [alleged infringer A] and [alleged infringer B, etc.] collectively infringe claim(s) [] of the [] patent.

For infringement to be proved, [patent holder] must prove by a preponderance of the evidence (1) that all the steps of the claimed process were performed in the United States and (2) that the acts of [alleged infringer B] are attributable to [alleged infringer A], either because [alleged infringer A] and [alleged infringer B] have formed a joint enterprise or because [alleged infringer A] directs or controls the acts of [alleged infringer B].

To prove that [alleged infringer A] and [alleged infringer B] have formed a joint enterprise, [Patent holder] must prove four elements:

- (1) there was an agreement, either express or implied, between [alleged infringer A] and [alleged infringer B];
- (2) they shared a common purpose;
- (3) each had a financial interest in that purpose; and
- (4) each had an equal right of control in the enterprise.

To prove that [alleged infringer A] directed or controlled the acts of [alleged infringer B], [Patent holder] must prove that [alleged infringer B] performed the claim step(s) in order to receive a benefit from [alleged infringer A] and that [alleged infringer A] established how or when the claim step(s) were performed.

Authorities

35 U.S.C. § 271(a); *Limelight Networks, Inc. v. Akamai Technologies, Inc.*, 797 F.3d 1020, 1022-24 (Fed. Cir. 2015) (en banc).

B.3 Infringement

3.8 [DELETED] INDIRECT INFRINGEMENT: ACCUSED INFRINGER PRACTICES SOME CLAIMED STEPS AND ANOTHER PRACTICES THE REMAINING STEPS

This instruction has been removed. See *Limelight Networks, Inc. v. Akamai Technologies, Inc.*, ___ U.S. ___, 134 S.Ct. 2111 (2014), No. 12-786, 2014 U.S. LEXIS 3817, 2014 WL 2440535 (U.S. June 2, 2014) (finding there can be no induced-infringement liability where no single entity is liable for direct infringement of the patent under §271(a) because “where there has been no direct infringement, there can be no inducement of infringement under §271(b)”).

B.3 Infringement

3.9 [DELETED] INDIRECT INFRINGEMENT: ACCUSED INFRINGER ALLEGEDLY INDUCES OTHERS TO COLLECTIVELY PRACTICE ALL CLAIMED STEPS

This instruction has been removed. See *Limelight Networks, Inc. v. Akamai Technologies, Inc.*, ___ U.S. ___, 134 S.Ct. 2111 (2014), No. 12-786, 2014 U.S. LEXIS 3817, 2014 WL 2440535 (U.S. June 2, 2014) (finding there can be no induced-infringement liability where no single entity is liable for direct infringement of the patent under §271(a) because “where there has been no direct infringement, there can be no inducement of infringement under §271(b)”).

B.3 Infringement

3.10 WILLFUL INFRINGEMENT

[This instruction should be given only if willfulness is in issue.]

In this case, [patent holder] argues both that [alleged infringer] infringed and, further, that [alleged infringer] infringed willfully. If you have decided that [alleged infringer] has infringed, you must go on and address the additional issue of whether or not this infringement was willful. Willfulness requires you to determine by clear and convincing evidence that [alleged infringer] acted recklessly.

To prove that [alleged infringer] acted recklessly, [patent holder] must prove two things by clear and convincing evidence:

The first part of the test is objective: the patent holder must persuade you that [alleged infringer] acted despite a high likelihood that [alleged infringer]'s actions infringed a valid and enforceable patent. In making this determination, you may not consider [alleged infringer]'s state of mind. Legitimate or credible defenses to infringement, even if not ultimately successful, demonstrate a lack of recklessness.¹

Only if you conclude that the [alleged infringer]'s conduct was reckless do you need to consider the second part of the test. The second part of the test does depend on the state of mind of the [alleged infringer]. The patent holder must persuade you that [alleged infringer] actually knew or should have known that its actions constituted an unjustifiably high risk of infringement of a valid and enforceable patent. To determine whether [alleged infringer] had this state of mind, consider all facts which may include, but are not limited, to:

- (1) Whether or not [alleged infringer] acted in accordance with the standards of commerce for its industry;
- (2) Whether or not [alleged infringer] intentionally copied a product of [patent holder] that is covered by the [] patent;
- (3) Whether or not there is a reasonable basis to believe that [alleged infringer] did not infringe or had a reasonable defense to infringement;

¹ In determining whether to present this instruction to the jury, the parties and the Court should recognize that “the objective determination of recklessness, even though predicated on underlying mixed questions of law and fact, is best decided by the judge as a question of law subject to de novo review.” *Bard Peripheral Vascular, Inc. v. W.L. Gore & Assocs., Inc.*, 682 F.3d 1003, 1007 (Fed. Cir. 2012). *See also id.* (“When the objective prong turns on fact questions, as related, for example, to anticipation, or on legal questions dependent on the underlying facts, as related, for example, to questions of obviousness, the judge remains the final arbiter of whether the defense was reasonable, even when the underlying fact question is sent to a jury.”).

- (4) Whether or not [alleged infringer] made a good-faith effort to avoid infringing the [] patent, for example, whether [alleged infringer] attempted to design around the [] patent; [and]
- (5) Whether or not [alleged infringer] tried to cover up its infringement[./; and]
- (6) [Give this instruction only if [alleged infringer] relies upon an opinion of counsel as a defense to an allegation of willful infringement:

[Alleged infringer] argues it did not act recklessly because it relied on a legal opinion that advised [alleged infringer] either (1) that the [product] [method] did not infringe the [] patent or (2) that the [] patent was invalid [or unenforceable]. You must evaluate whether the opinion was of a quality that reliance on its conclusions was reasonable.]

Authorities

35 U.S.C. § 284; *In re Seagate Tech., LLC*, 497 F.3d 1360 (Fed. Cir. 2007) (standard for finding willfulness); *Knorr-Bremse v. Dana Corp.*, 383 F.3d 1337 (Fed. Cir. 2004) (en banc) (opinion of counsel defense); *Crystal Semiconductor Corp. v. Tritech Microelectronics Int'l, Inc.*, 246 F.3d 1336, 1346 (Fed. Cir. 2001) (burden of proof for willfulness); *WMS Gaming Inc. v. Int'l Game Tech.*, 184 F.3d 1339, 1354 (Fed. Cir. 1999) (knowledge of the patent necessary to show willfulness); *Read Corp. v. Portec, Inc.*, 970 F.2d 816 (Fed. Cir. 1992) (identifying factors that may show willfulness); *Gustafson, Inc. v. Intersystems Indus. Prods., Inc.*, 897 F.2d 508, 510 (Fed. Cir. 1990) (history of Federal Circuit decisions on willfulness).

Committee Comments: The National Patent Jury Instructions include whether the alleged infringer acted in a manner consistent with the standards of commerce for its industry in the subjective part of the test. (www.nationaljuryinstructions.org.) Some other pattern jury instructions decline to provide a list of nonexhaustive considerations, *see, e.g.*, Seventh Circuit, 2008 Patent Jury Instructions, at 11.2.14, on the theory that the factors are better left to attorney argument or may mislead a jury to believe other factors should not be considered. (www.ca7.uscourts.gov/Pattern-Jury-Instr.) Appropriate factors for the jury's consideration may be tailored to each case, or may be omitted.

B.4 Validity

4.1 INVALIDITY—BURDEN OF PROOF

I will now instruct you on the rules you must follow in deciding whether or not [alleged infringer] has proven that claims [] of the [] patent are invalid. To prove that any claim of a patent is invalid, [alleged infringer] must persuade you by clear and convincing evidence, i.e., you must be left with a clear conviction that the claim is invalid.

Authorities

35 U.S.C. § 282 (patents presumed valid); *Microsoft Corp. v. i4i Limited Partnership*, 131 S.Ct. 2238 (2011). Invalidity may be asserted for failure to comply with any requirement of 35 U.S.C. § 101, 102, 103, 112, or 251, as a defense to alleged infringement. *Schumer v. Lab. Computer Sys., Inc.*, 308 F.3d 1304, 1315 (Fed. Cir. 2002) (to overcome presumption of validity, challenging party must present clear and convincing evidence of invalidity); *Buildex, Inc. v. Kason Indus., Inc.*, 849 F.2d 1461, 1463 (Fed. Cir. 1988) (clear and convincing evidence is that “which produces in the mind of the trier of fact an abiding conviction that the truth of [the] factual contentions are highly probable”) (alteration in original) (citation and internal quotation marks omitted); *Hybritech Inc. v. Monoclonal Antibodies, Inc.*, 802 F.2d 1367, 1375 (Fed. Cir. 1986) (“Notwithstanding that the introduction of prior art not before the examiner may facilitate the challenger’s meeting the burden of proof on invalidity, the presumption remains intact and on the challenger throughout the litigation, and the clear and convincing standard does not change.”).

B.4.2 Validity—Adequacy of Patent Specification

4.2a WRITTEN DESCRIPTION REQUIREMENT

The patent law contains certain requirements for the part of the patent called the specification. [Alleged infringer] contends that claim(s) [] of [patent holder]’s [] patent [is/are] invalid because the specification of the [] patent does not contain an adequate written description of the invention. To succeed, [alleged infringer] must show by clear and convincing evidence that the specification fails to meet the law’s requirements for written description of the invention. In the patent application process, the applicant may keep the originally filed claims, or change the claims between the time the patent application is first filed and the time a patent is issued. An applicant may amend the claims or add new claims. These changes may narrow or broaden the scope of the claims. The written description requirement ensures that the issued claims correspond to the scope of the written description that was provided in the original application.

In deciding whether the patent satisfies this written description requirement, you must consider the description from the viewpoint of a person having ordinary skill in the field of technology of the patent when the application was filed. The written description requirement is satisfied if a person having ordinary skill reading the original patent application would have recognized that it describes the full scope of the claimed invention as it is finally claimed in the issued patent and that the inventor actually possessed that full scope by the filing date of the original application.

The written description requirement may be satisfied by any combination of the words, structures, figures, diagrams, formulas, etc., contained in the patent application. The full scope of a claim or any particular requirement in a claim need not be expressly disclosed in the original patent application if a person having ordinary skill in the field of technology of the patent at the time of filing would have understood that the full scope or missing requirement is in the written description in the patent application.

Authorities

35 U.S.C. § 112, ¶¶ 1, 2; *Ariad Pharmaceuticals, Inc. v. Eli Lilly & Co.*, 598 F.3d 1336 (Fed. Cir. 2010) (en banc); *Lizard Tech., Inc. v. Earth Res. Mapping Inc.*, 424 F.3d 1336, 1344-45 (Fed. Cir. 2005); *Univ. of Rochester v. G.D. Searle & Co.*, 358 F.3d 916, 929 (Fed. Cir. 2004); *Chiron Corp. v. Genentech, Inc.*, 363 F.3d 1247, 1253-55 (Fed. Cir. 2004); *Purdue Pharma L.P. v. Faulding, Inc.*, 230 F.3d 1320, 1323 (Fed. Cir. 2000) (patent’s specification must include an adequate written description; however, it need not include the exact words of the claim); *Lampi Corp. v. Am. Power Prods., Inc.*, 228 F.3d 1365, 1377-78 (Fed. Cir. 2000); *Gentry Gallery, Inc. v. Berkline Corp.*, 134 F.3d 1473, 1478-80 (Fed. Cir. 1998); *Regents of the Univ. of Cal. v. Eli Lilly & Co.*, 119 F.3d 1559, 1568 (Fed. Cir. 1997); *In re Alton*, 76 F.3d 1168, 1172 (Fed. Cir. 1996).

B.4.2 Validity—Adequacy of Patent Specification

4.2b ENABLEMENT

The patent law contains certain requirements for the part of the patent called the specification. [Alleged infringer] contends that claim(s) [] of [patent holder]’s [] patent [is/are] invalid because the specification does not contain a sufficiently full and clear description of how to make and use the full scope of the claimed invention. To succeed, [alleged infringer] must show by clear and convincing evidence that the [] patent does not contain a sufficiently full and clear description of the claimed invention. To be sufficiently full and clear, the description must contain enough information to have allowed a person having ordinary skill in the field of technology of the patent to make and use the full scope of the claimed invention at the time the [original] patent application was filed. This is known as the “enablement” requirement. If a patent claim is not enabled, it is invalid.

In order to be enabling, the patent must permit persons having ordinary skill in the field of technology of the patent to make and use the full scope of the claimed invention at the time of [original] filing without having to conduct undue experimentation. However, some amount of experimentation to make and use the invention is allowable. In deciding whether a person having ordinary skill would have to experiment unduly in order to make and use the invention, you may consider several factors:

- (1) the time and cost of any necessary experimentation;
- (2) how routine any necessary experimentation is in the field of [identify field];
- (3) whether the patent discloses specific working examples of the claimed invention;
- (4) the amount of guidance presented in the patent;
- (5) the nature and predictability of the field of [identify field];
- (6) the level of ordinary skill in the field of [identify field]; and
- (7) the scope of the claimed invention.

No one or more of these factors is alone dispositive. Rather, you must make your decision whether or not the degree of experimentation required is undue based upon all of the evidence presented to you. You should weigh these factors and determine whether or not, in the context of this invention and the state of the art at the time of the [original] application, a person having ordinary skill would need to experiment unduly to make and use the full scope of the claimed invention.

Authorities

35 U.S.C. § 112, ¶ 1; *Sitrick v. Dreamworks, LLC*, 516 F.3d 993, 999 (Fed. Cir. 2008) (“The scope of the claims must be less than or equal to the scope of the enablement’ to ‘ensure[] that

the public knowledge is enriched by the patent specification to a degree at least commensurate with the scope of the claims.”) (quoting *Nat’l Recovery Techs., Inc. v. Magnetic Separation Sys., Inc.*, 166 F.3d 1190, 1195-96 (Fed. Cir. 1999)); *Auto. Techs. Int’l, Inc. v. BMW of N. Am., Inc.*, 501 F.3d 1274, 1285 (Fed. Cir. 2007) (full scope of claimed invention must be enabled); *AK Steel Corp. v. Sollac*, 344 F.3d 1234, 1244 (Fed. Cir. 2003) (enabling the full scope of each claim is “part of the *quid pro quo* of the patent bargain”); *Union Pac. Res. Co. v. Chesapeake Energy Corp.*, 236 F.3d 684, 690-92 (Fed. Cir. 2001); *Ajinomoto Co. v. Archer-Daniels-Midland Co.*, 228 F.3d 1338, 1345-46 (Fed. Cir. 2000); *In re Wands*, 858 F.2d 731, 737 (Fed. Cir. 1988) (factors for determining undue experimentation).

B.4.2 Validity—Adequacy of Patent Specification

4.2c [DELETED] BEST MODE

This instruction has been removed because under section 15 of the America Invents Act, enacted on September 16, 2011, failure to disclose the best mode is no longer a basis for invalidity or unenforceability.

B.4.3 Validity—The Claims

4.3a-1 PRIOR ART (For Patents Having an Effective Filing Date Before March 16, 2013)

Prior art may include items that were publicly known or that have been used or offered for sale, or references, such as publications or patents, that disclose the claimed invention or elements of the claimed invention. To be prior art, the item or reference must have been made, known, used, published, or patented either before the invention was made or [insert date if undisputed] or more than one year before the filing date of the patent application. However, prior art does not include a publication that describes the inventor's own work and was published less than one year before the date of invention. [Where appropriate, add limitation that subject matter developed by another which qualifies as prior art only under one or more of subsections (e), (f), and (g) of 35 U.S.C. § 102 where the subject matter and the claimed invention were, at the time the claimed invention was made, owned by the same person, or subject to an obligation of assignment to the same person.]

[For anticipation:

For the claim to be invalid because it is not new, [alleged infringer] must show by clear and convincing evidence that all of the requirements of that claim were present in a single previous device or method that was known of, used, or described in a single previous printed publication or patent. We call these things “anticipating prior art.” To anticipate the invention, the prior art does not have to use the same words as the claim, but all of the requirements of the claim must have been disclosed, either stated expressly or implied to a person having ordinary skill in the art in the technology of the invention, so that looking at that one reference, that person could make and use the claimed invention.]

[If invention date is disputed: In this case, you must determine the date of invention [or conception] [and/or] [reduction to practice] for the [claimed invention or alleged prior art].

The date of invention is either when the invention was reduced to practice or when conceived, provided the inventor(s) were diligent in reducing the invention to practice. Diligence means working continuously, though not necessarily every day. Conception is the mental part of an inventive act, i.e., the formation in the mind of the inventor of a definite and permanent idea of the complete and operative invention as it is thereafter to be applied in practice, even if the inventor did not know at the time that the invention would work. Conception of an invention is complete when the idea is so clearly defined in the inventor's mind that, if the idea were communicated to a person having ordinary skill in the field of the technology, he or she would be able to reduce the invention to practice without undue research or experimentation. This requirement does not mean that the inventor has to have a prototype built, or actually explained her or his invention to another person. But, there must be some evidence beyond the inventor's own testimony that confirms the date on which the inventor had the complete idea. Conception may be proven when the invention is shown in its complete form by drawings, disclosure to another person, or other forms of evidence presented at trial.

Appendix E: Model Patent Jury Instructions

A claimed invention is “reduced to practice” when it has been constructed/used/tested sufficiently to show that it will work for its intended purpose or when the inventor files a patent application. An invention may also be reduced to practice even if the inventor has not made or tested a prototype of the invention if it has been fully described in a filed patent application.]

B.4.3 Validity—The Claims

4.3b-1 ANTICIPATION (For Patents Having an Effective Filing Date Before March 16, 2013)

In order for someone to be entitled to a patent, the invention must actually be “new” and the inventor must not have lost her or his rights by delaying the filing of an application claiming the invention. In general, inventions are new when the identical [product or process] has not been made, used, or disclosed before. Anticipation must be determined on a claim-by-claim basis.

[Alleged infringer] contends that claim(s) [] of the [] patent is/are invalid because the claimed invention(s) is/are anticipated or because [patent holder] lost the right to obtain a patent. [Alleged infringer] must convince you of this by clear and convincing evidence, i.e., that the evidence highly probably demonstrates that the claim(s) is/are invalid.

Here is a list of ways that [alleged infringer] can show that a patent claim was not new or that the patentee lost the right to patent the claim(s) [choose those that apply based on alleged infringer’s contentions]:

- (1) An invention is not new if it was known to or used by others in the United States before the [insert date of invention]. An invention is known when the information about it was reasonably accessible to the public on that date.
- (2) An invention is not new if it was already patented or described in a printed publication, anywhere in the world before the [insert date of invention]. [A description is a “printed publication” only if it was publicly accessible.]
- (3) [Patent holder] has lost her or his rights if the claimed invention was already patented or described in a printed publication, anywhere in the world by [patent holder] or anyone else, more than a year before [insert date], which is the effective filing date of the application for the [] patent. An invention was patented by another if the other patent describes the same invention claimed by [patent holder] to a person having ordinary skill in the technology.
- (4) [Patent holder] has lost her or his rights if the claimed invention was publicly used, sold, or offered for sale in the United States more than one year before [insert date], which is the effective filing date of the application for the [] patent. An invention was publicly used when it was either accessible to the public or commercially exploited. An invention was sold or offered for sale when it was offered commercially and what was offered was ready to be patented, i.e., a description to one having ordinary skill in the field of the technology could have made and used the claimed invention, even if it was not yet reduced to practice.
- (5) [Patent holder] has lost his or her rights if he or she abandoned the invention.
- (6) [Patent holder] has lost her or his rights if she or he had already obtained a patent for the invention in a foreign country before the filing date of the application in the United States or the patent application was filed in a foreign country more than a year before the filing date of the application for the patent in the United States.

(7) An invention is not new if it was described in a published patent application filed by another in the United States [or under the PCT system and designated the United States, and was published in English] before [insert date of invention].

(8) An invention is not new if the claimed invention was described in a patent granted on an application for patent by another filed in the United States [or under the PCT system and designated the United States, and was published in English] and the application was filed before [insert date of reduction to practice or the filing date of the application for the [] patent].

(9) [Patent holder] is not entitled to the [] patent if [named inventor] did not himself invent the invention.

(10) An invention is not new if the invention was made by someone else in the United States before the invention was made by [patent holder] and the other person did not abandon, suppress, or conceal the invention.

If an interference proceeding has been declared, additional instructions should be given on this issue.

Authorities

35 U.S.C. § 102(a)-(g); *Flex-Rest, LLC v. Steelcase, Inc.*, 455 F.3d 1351, 1358-60 (Fed. Cir. 2006); *Invitrogen Corp. v. Biocrest Mfg., L.P.*, 424 F.3d 1374, 1379-82 (Fed. Cir. 2005); *In re Klopfenstein*, 380 F.3d 1345, 1348-51 (Fed. Cir. 2004); *Toro Co. v. Deere & Co.*, 355 F.3d 1313, 1320-21 (Fed. Cir. 2004); *Schering Corp. v. Geneva Pharms., Inc.*, 339 F.3d 1373, 1377-80 (Fed. Cir. 2003); *Apotex U.S.A., Inc. v. Merck & Co.*, 254 F.3d 1031, 1035 (Fed. Cir. 2001); *Mycogen Plant Sci., Inc. v. Monsanto Co.*, 243 F.3d 1316, 1330-31 (Fed. Cir. 2001); *Ecolochem, Inc. v. S. Cal. Edison Co.*, 227 F.3d 1361, 1367-70 (Fed. Cir. 2000); *Singh v. Brake*, 222 F.3d 1362, 1366-70 (Fed. Cir. 2000); *Pannu v. Iolab Corp.*, 155 F.3d 1344, 1349 (Fed. Cir. 1998); *Gambro Lundia AB v. Baxter Healthcare Corp.*, 110 F.3d 1573, 1576-78 (Fed. Cir. 1997); *Lamb-Weston, Inc. v. McCain Foods, Ltd.*, 78 F.3d 540, 545 (Fed. Cir. 1996); *In re Bartfeld*, 925 F.2d 1450, 1452-53 (Fed. Cir. 1991); *Ralston Purina Co. v. Far-Mar-Co, Inc.*, 772 F.2d 1570, 1574 (Fed. Cir. 1985); *Am. Stock Exch., LLC v. Mopex, Inc.*, 250 F. Supp. 2d 323, 328-32 (S.D.N.Y. 2003); *In re Wyer*, 655 F.2d 221, 226 (C.C.P.A. 1981); *Pfaff v. Wells Elecs. Inc.*, 525 U.S. 55 (1998); *Helifix Ltd. v. Blok-Lok, Ltd.*, 208 F.3d 1339, 1346 (Fed. Cir. 2000); *Abbott Labs. v. Geneva Pharms., Inc.*, 182 F.3d 1315, 1318 (Fed. Cir. 1999); *Finnigan Corp. v. ITC*, 180 F.3d 1354, 1365 (Fed. Cir. 1999); *J.A. LaPorte, Inc. v. Norfolk Dredging Co.*, 787 F.2d 1577, 1581 (Fed. Cir. 1986); *In re Hall*, 781 F.2d 897, 898-99 (Fed. Cir. 1986); *D.L. Auld Co. v. Chroma Graphics Corp.*, 714 F.2d 1144, 1147-50 (Fed. Cir. 1983).

4.3a-2 PRIOR ART
(For Patents Having an Effective Filing Date on or After March 16, 2013)

Prior art to a patent may include:

- (1) items that were publicly known or that have been used, on sale, or otherwise made available to the public before the filing date of the patent,
- (2) publications that were published or otherwise made available to the public before the filing date of the patent, and
- (3) patents and published patent applications naming another inventor that were filed before the filing date of the patent.

However, prior art does not include:

an item or publication that (a) is the inventor's own work or (b) describes the inventor's own work or (c) was directly or indirectly obtained from the inventor, unless it was made public more than one year before the filing date of the patent's application, or

a patent or patent application that (a) discloses the inventor's own work or (b) was directly or indirectly obtained from the inventor or (c) was owned by the same person or subject to an obligation of assignment to the same person.

[For anticipation:

For the claim to be invalid because it is not new, [alleged infringer] must show by clear and convincing evidence that all of the requirements of that claim were present in a single previous device or method that was known of, used, or described in a single previous printed publication or patent. We call these things "anticipating prior art." To anticipate the invention, the prior art does not have to use the same words as the claim, but all of the requirements of the claim must have been disclosed, either stated expressly or implied to a person having ordinary skill in the art in the technology of the invention, so that looking at that one reference, that person could make and use the claimed invention.]

Authorities

35 U.S.C. § 102(a)(1)-(2); 35 U.S.C. § 102(b)(1)-(2).

B.4.3 Validity—The Claims

4.3c OBVIOUSNESS

Even though an invention may not have been identically disclosed or described before it was made by an inventor, in order to be patentable, the invention must also not have been obvious to a person of ordinary skill in the field of technology of the patent [at the time the invention was made] or [before the filing date of the patent].²

[Alleged infringer] may establish that a patent claim is invalid by showing, by clear and convincing evidence, that the claimed invention would have been obvious to persons having ordinary skill in the art at the time the [invention was made] or [patent was filed] in the field of [insert the field of the invention].

In determining whether a claimed invention is obvious, you must consider the level of ordinary skill in the field [of the invention] that someone would have had at the time the [invention was made] or [patent was filed], the scope and content of the prior art, and any differences between the prior art and the claimed invention.

Keep in mind that the existence of each and every element of the claimed invention in the prior art does not necessarily prove obviousness. Most, if not all, inventions rely on building blocks of prior art. In considering whether a claimed invention is obvious, you may but are not required to find obviousness if you find that at the time of the claimed invention [or the patent's filing date] there was a reason that would have prompted a person having ordinary skill in the field of [the invention] to combine the known elements in a way the claimed invention does, taking into account such factors as (1) whether the claimed invention was merely the predictable result of using prior art elements according to their known function(s); (2) whether the claimed invention provides an obvious solution to a known problem in the relevant field; (3) whether the prior art teaches or suggests the desirability of combining elements claimed in the invention; (4) whether the prior art teaches away from combining elements in the claimed invention; (5) whether it would have been obvious to try the combinations of elements, such as when there is a design need or market pressure to solve a problem and there are a finite number of identified, predictable solutions; and (6) whether the change resulted more from design incentives or other market forces. To find it rendered the invention obvious, you must find that the prior art provided a reasonable expectation of success. Obvious to try is not sufficient in unpredictable technologies.

In determining whether the claimed invention was obvious, consider each claim separately. Do not use hindsight, i.e., consider only what was known at the time of the invention [or the patent's filing date].

² The “at the time invention was made” standard is used for patents that were filed before March 16, 2013. For patents filed on or after March 16, 2013, the appropriate standard is “before the effective filing date of the claimed invention.”

In making these assessments, you should take into account any objective evidence (sometimes called “secondary considerations”) that may shed light on the obviousness or not of the claimed invention, such as:

- a. Whether the invention was commercially successful as a result of the merits of the claimed invention (rather than the result of design needs or market-pressure advertising or similar activities);
- b. Whether the invention satisfied a long-felt need;
- c. Whether others had tried and failed to make the invention;
- d. Whether others invented the invention at roughly the same time;
- e. Whether others copied the invention;
- f. Whether there were changes or related technologies or market needs contemporaneous with the invention;
- g. Whether the invention achieved unexpected results;
- h. Whether others in the field praised the invention;
- i. Whether persons having ordinary skill in the art of the invention expressed surprise or disbelief regarding the invention;
- j. Whether others sought or obtained rights to the patent from the patent holder; and
- k. Whether the inventor proceeded contrary to accepted wisdom in the field.

B.4.3 Validity—The Claims

4.3c(i) LEVEL OF ORDINARY SKILL

In deciding what the level of ordinary skill in the field of [invention] is, you should consider all the evidence introduced at trial, including but not limited to: (1) the levels of education and experience of the inventor and other persons actively working in the field; (2) the types of problems encountered in the field; (3) prior art solutions to those problems; (4) rapidity with which innovations are made; and (5) the sophistication of the technology.

4.3c(ii) SCOPE AND CONTENT OF THE PRIOR ART

[Option 1: parties stipulate to prior art.]

In considering whether the claimed invention was obvious at the time it was made, you should consider the scope and content of the following prior art: [Insert art as stipulated].

[Option 2: parties dispute the prior art.]

In considering whether the claimed invention was obvious, you must first determine the scope and content of the prior art.

The scope and content of prior art for deciding whether the invention was obvious includes at least prior art in the same field as the claimed invention. It also includes prior art from different fields that a person of ordinary skill in the art would have considered when trying to solve the problem that is addressed by the invention.

Where the party challenging the validity of the patent is relying on prior art that was not considered by the PTO during examination, you may consider whether that prior art is significantly different and more relevant than the prior art that the PTO did consider. If you decide it was different and more relevant, you may weigh that prior art more heavily when considering whether the challenger has carried its clear-and-convincing burden of proving invalidity.

Authorities

35 U.S.C. § 103. The four-factor test, including articulation of the objective factors, is found in *Graham v. John Deere Co.*, 383 U.S. 1, 17-18 (1966); *see also Ruiz v. A.B. Chance Co.*, 234 F.3d 654, 662-63 (Fed. Cir. 2000). The test was reaffirmed in *KSR International Co. v. Teleflex Inc.*, 550 U.S. 398, 407 (2007) (“While the sequence of these questions might be reordered in any particular case, the factors continue to define the inquiry that controls.”). *See also Cordis Corp. v. Medtronic Ave., Inc.*, 511 F.3d 1157, 1172 (Fed. Cir. 2008).

In cases where the invalidity defense is based on a combination of prior art, the proper inquiry is a flexible analysis considering whether, among other factors, the prior art teaches, suggests, or motivates the claimed invention. *KSR*, 550 U.S. at 419-20; *Esai Co. v. Dr. Reddy’s Labs. Ltd.*,

533 F.3d 1353, 1356-57 (Fed. Cir. 2008); *Takeda Chem. Indus., Ltd. v. Alphapharm Pty., Ltd.*, 492 F.3d 1350, 1356-57 (Fed. Cir. 2007); *Hybritech Inc. v. Monoclonal Antibodies, Inc.*, 802 F.2d 1367, 1380-81 (Fed. Cir. 1986).

For patents having filing dates before March 16, 2013, obviousness should be assessed at the time of the invention. For patents having filing dates on or after March 16, 2013, obviousness should be assessed at the time just before the patent's effective filing date. In either case, fact-finders should be made aware "of the distortion caused by hindsight bias and must be cautious of arguments reliant upon *ex post* reasoning." *KSR*, 550 U.S. at 421.

For recent authority that invalidity must be shown by clear and convincing evidence, but that this burden can be carried more easily when the challenger is relying on prior art materially different from the art considered during examination, see *Microsoft Corp. v. i4i Limited Partnership*, 131 S.Ct. 2238 (2011). Obviousness should be evaluated on a claim-by-claim basis. *Aventis Pharma Deutschland GmbH v. Lupin, Ltd.*, 499 F.3d 1293, 1303 (Fed. Cir. 2007).

For factors to consider in determining the level of ordinary skill, see, e.g., *Daiichi Sankyo Co. v. Apotex, Inc.*, 501 F.3d 1254, 1256 (Fed. Cir. 2007); *Ruiz*, 234 F.3d at 666-67. For authority on the standards for determining the scope and content of prior art, see, e.g., *KSR*, 550 U.S. at 420; *Circuit Check, Inc. v. QXQ Inc.*, 795 F.3d 1331, 1482 (Fed. Cir. 2015) (stating that when considering whether prior art is analogous, "the question is whether an inventor would look to this particular art to solve the particular problem at hand"); *In re Icon Health & Fitness, Inc.*, 496 F.3d 1374, 1379-80 (Fed. Cir. 2007); *Princeton Biochems., Inc. v. Beckman Coulter, Inc.*, 411 F.3d 1332, 1339 (Fed. Cir. 2005).

B.4.3 Validity—The Claims

4.3d INVENTORSHIP

[This instruction should only be given in the event the alleged infringer has contended that the patent suffers from improper inventorship.]

In this case, [alleged infringer] contends that the [] patent is invalid because of improper inventorship. A patent is invalid if it fails to meet the requirement that all of the actual inventors, and only the actual inventors, be named as inventors in the patent. This is known as the “inventorship” requirement.

To be an inventor, one must make a significant contribution to the conception of at least one or more of the claims of the patent [even if that claim has not been alleged to be infringed]. Whether the contribution is significant is measured against the scope of the full invention.

If someone only explains to the actual inventors well-known concepts or the current state of the art, he or she is not an inventor. Merely helping with experimentation, by carrying out the inventor’s instructions, also does not make someone an inventor. What is required is some significant contribution to the idea claimed.

Persons may be inventors even if they do not make the same type or amount of contribution, and even if they do not contribute to the subject matter of each claim of the patent. Persons may be joint or co-inventors even though they do not physically work together, but they must have some open line of communication during or at approximately the time of their inventive effort.

Authorities

35 U.S.C. §§ 102, 256; *Pannu v. Iolab Corp.*, 155 F.3d 1344, 1349-50 (Fed. Cir. 1998) (“If a patentee demonstrates that inventorship can be corrected as provided for in section 256, a district court must order correction of the patent, thus saving it from being rendered invalid.”); *Eli Lilly & Co. v. Aradigm Corp.*, 376 F.3d 1352, 1358-59 (Fed. Cir. 2004); *Hess v. Advanced Cardiovascular Sys. Inc.*, 106 F.3d 976, 980-81 (Fed. Cir. 1997) (applying “clear and convincing evidence” standard to inventorship claims and finding plaintiff who offered suggestions to named inventors was not an inventor); *Burroughs Wellcome Co. v. Barr Labs., Inc.*, 40 F.3d 1223, 1227-28 (Fed. Cir. 1994); *Shatterproof Glass Corp. v. Libbey-Owens Ford Co.*, 758 F.2d 613, 624 (Fed. Cir. 1985).

B.5 Equitable Defenses

[Although these equitable defenses are ultimately decided by the Court, these instructions are provided for the case in which the Court decides to submit these issues to the jury for advisory findings.]

5.1 INEQUITABLE CONDUCT

Every applicant for a patent has a duty of candor and good faith in its dealing with the United States Patent and Trademark Office. This is important because the PTO has limited resources.

When a person involved in the prosecution of an application fails to supply material information or supplies false information or statements and does so with an intent to deceive the PTO, he or she may commit what is called “inequitable conduct.” When inequitable conduct occurs during the examination of an application, any patent that issues from that application is unenforceable as a matter of fairness. This means that despite the existence and validity of the patent, the patent holder may not prevent others from using the invention covered by the patent and may not collect damages from those who use the invention that is covered by the patent.

Because a finding of inequitable conduct completely extinguishes a patent holder’s right to prevent others from using an invention, the burden of proving inequitable conduct is high. [Alleged infringer] must prove by clear and convincing evidence both that a person meaningfully involved in the prosecution of the [] patent withheld material information or submitted materially false information or statements to the PTO during the examination of the [] patent(s), and that the person did so with an intent to deceive the Examiner into issuing the [] patent(s).

I will now explain to you what “material” and “intent to deceive” mean.

Material

Information that was withheld from the PTO is material if the PTO would not have allowed the claim had it been aware of the withheld information. A false or misleading statement is material when it convinces the PTO to allow a claim that it would not have allowed if the statement had not been made. You may also find that affirmative, egregious misconduct is material. An example of affirmative, egregious misconduct is the filing of an unmistakably false affidavit.

You may only find information, statements, or misconduct to be material if there is clear and convincing evidence that they are material.

Intent to Deceive

In order for inequitable conduct to have occurred, [alleged infringer] must establish that any [failure to disclose material information/false or misleading statements/misconduct] [was/were] done with an intent to deceive the Examiner. If the [failure to disclose material information/false or misleading statements/misconduct] occurred through negligence, oversight, carelessness, or an error in judgment, even if it was grossly negligent, then there was no intent to deceive and there is no inequitable conduct.

Intent may be shown through direct evidence, such as documents or testimony about one's intent to deceive. Intent also may be shown through indirect evidence or, in other words, it may be inferred from conduct. However, an intent to deceive may be inferred only where it is the single most reasonable inference that can be drawn from the evidence. In other words, if it could be reasonable to conclude that the [failure to disclose material information/false or misleading statements/misconduct] was an honest mistake, intent to deceive cannot be found.

Conclusion of Inequitable Conduct

Materiality and intent to deceive are separate issues: proof of materiality does not give rise to an inference of intent to deceive, and proof of an intent to deceive does not give rise to an inference of materiality. There must be clear and convincing evidence that establishes materiality and there must be clear and convincing evidence that establishes an intent to deceive. If clear and convincing evidence of either, or both, is missing, there can be no inequitable conduct.

If you find, however, that [alleged infringer] has proved by clear and convincing evidence that [material information was withheld/materially misleading statements were made or false information provided/affirmative, egregious misconduct occurred] and, further, that these acts or omissions were done with an intent to deceive the Examiner, you must then determine whether the patent(s) should in fairness be declared unenforceable.

Authorities

35 U.S.C. § 282; *Therasense Inc. v. Becton, Dickinson and Co.*, 649 F.3d 1276 (Fed. Cir. 2011) (en banc).

B.5 Equitable Defenses

5.2 LACHES

[Alleged infringer] contends that [patent holder] is not entitled to recover damages for acts that occurred before it filed a lawsuit because: (1) [patent holder] delayed filing the lawsuit for an unreasonably long and inexcusable period of time, and (2) [alleged infringer] has been or will be prejudiced in a significant way due to [patent holder]’s delay in filing the lawsuit. This is referred to as laches. [Alleged infringer] must prove delay and prejudice by a preponderance of the evidence.

Whether [patent holder]’s delay was unreasonably long and unjustified is a question that must be answered by considering the facts and circumstances as they existed during the period of delay. There is no minimum amount of delay required to establish laches. If suit was delayed for six years, a rebuttable presumption arises that the delay was unreasonable and unjustified, and that material prejudice resulted. This presumption shifts the burden of proof to [patent holder] to come forward with evidence to prove that the delay was justified or that material prejudice did not result, and if [patent holder] presents such evidence, the burden of proving laches remains with [alleged infringer]. Laches may be found for delays of less than six years if there is proof of unreasonably long and unjustifiable delay causing material prejudice to [alleged infringer]. Facts and circumstances that can justify a long delay can include:

- (1) being involved in other litigation during the period of delay;
- (2) being involved in negotiations with [alleged infringer] during the period of delay;
- (3) poverty or illness during the period of delay;
- (4) wartime conditions during the period of delay;
- (5) being involved in a dispute about ownership of the patent during the period of delay; or
- (6) minimal amounts of allegedly infringing activity by [alleged infringer] during the period of delay.

If you find unreasonable and unjustified delay occurred, to find laches, you must also determine if [alleged infringer] suffered material prejudice as a result of the delay. Prejudice to [alleged infringer] can be evidentiary or economic. Whether [alleged infringer] suffered evidentiary prejudice is a question that must be answered by evaluating whether delay in filing this case resulted in [alleged infringer] not being able to present a full and fair defense on the merits to [patent holder]’s infringement claim. Not being able to present a full and fair defense on the merits to an infringement claim can occur due to the loss of important records, the death or impairment of an important witness(es), the unreliability of memories about important events because they occurred in the distant past, or other similar types of things. Economic prejudice is determined by whether or not [alleged infringer] changed its economic position in a significant way during the period of delay resulting in losses beyond merely paying for infringement (such

as if [alleged infringer] could have switched to a noninfringing product if sued earlier), and also whether [alleged infringer]'s losses as a result of that change in economic position likely would have been avoided if [patent holder] had filed this lawsuit sooner. In all scenarios though, the ultimate determination of whether laches should apply in this case is a question of fairness, given all the facts and circumstances. Thus, you may find that laches does not apply if there is no evidence establishing each of the three elements noted above (unreasonable delay, lack of excuse or justification, and significant prejudice). You may also find that even though all of the elements of laches have been proved, it should not, in fairness, apply, given all the facts and circumstances in this case.

Authorities

35 U.S.C. § 282; *Gasser Chair Co. v. Infanti Chair Mfg. Corp.*, 60 F.3d 770, 773-74 (Fed. Cir. 1995); *A.C. Aukerman Co. v. R.L. Chaides Constr. Co.*, 960 F.2d 1020, 1039 (Fed. Cir. 1992) (en banc).

B.5 Equitable Defenses

5.3 EQUITABLE ESTOPPEL

The owner of a patent may forfeit its right to any relief from an infringer where: (1) the patent holder communicates something in a misleading way to the infringing party about the lack of infringement or about not being sued, (2) the infringer relies upon the misleading communication from the patent holder, and (3) the infringer will be materially harmed if the patent holder is allowed to assert a claim relating to the issue that is inconsistent with the patent holder's prior misleading communication. This is referred to as an "equitable estoppel" and it is a defense that [alleged infringer] contends precludes any recovery by [patent holder] in this lawsuit. [Alleged infringer] must prove each of these elements by a preponderance of the evidence, but even if all these elements are proven, equitable estoppel need not be found if such a finding would be unfair in light of the conduct of the parties.

[Alleged infringer] contends that [patent holder] made a misleading communication about [] before [patent holder] filed this lawsuit. A communication may be made through written or spoken words, conduct, silence, or a combination of words, conduct, and silence. Conduct may include action or inaction. Whether in fact [patent holder] communicated with [alleged infringer] about [] prior to the filing of this lawsuit, and whether in fact that communication, if you find there to have been any, was misleading, are questions that must be answered by considering the facts and circumstances as they existed at the time.

Material harm to [alleged infringer] can be evidentiary or economic in form. Whether [alleged infringer] suffered evidentiary harm is a question that must be answered by evaluating whether [alleged infringer] will be unable to present a full and fair defense on the merits of [patent holder]'s claim(s). Not being able to present a full and fair defense on the merits of [patent holder]'s claim(s) can occur due to the loss of important records, the death or impairment of an important witness(es), the unreliability of memories about important events because they occurred in the distant past, or other similar types of things. Whether [alleged infringer] suffered economic prejudice is a question that must be answered by evaluating whether [alleged infringer] changed its economic position as a result of its reliance on any misleading communication from [patent holder] about [], resulting in losses beyond merely paying for infringement (such as if [alleged infringer] could have switched to a noninfringing product if sued earlier) and whether losses as a result of any change in economic position could have been avoided.

Authorities

35 U.S.C. § 282; *Gasser Chair Co. v. Infanti Chair Mfg. Corp.*, 60 F.3d 770 (Fed. Cir. 1995) (to establish equitable estoppel, one must show reliance on patentee's misleading conduct); *A.C. Aukerman Co. v. R.L. Chaides Constr. Co.*, 960 F.2d 1020 (Fed. Cir. 1992) (en banc).

B.5 Equitable Defenses

5.4 PROSECUTION LACHES

The owner of a patent may be barred from enforcing claims of a patent against an infringer where: (1) there was an unreasonably long delay in filing the claims of the patent, and (2) the infringer, another private party, or the public will be prejudiced if the patent holder is entitled to enforce the patent despite the unreasonable delay in securing the claims of the patent. This is referred to as prosecution laches, and it is a defense that [alleged infringer] contends precludes any recovery by [patent holder] in this lawsuit.

The delay that must be considered is the period of time beginning when [patent holder or its predecessor(s) in interest] filed the original application for a patent and ending when [patent holder or its predecessor(s) in interest] filed the application for the patent asserted in this lawsuit. [Patent holder] filed the original application for a patent on [], and filed the application for the patent asserted in this lawsuit on [].

Whether [patent holder]'s delay in securing the patent asserted in this lawsuit was unreasonably long is a question that must be answered, and you should consider the facts and circumstances as they existed during the period of delay. In determining whether [alleged infringer], another private party, or the public will be prejudiced as a result of any unreasonably long delay in filing the claims of the patent(s) asserted in this case, consider whether [alleged infringer] or others invested time, money, and effort in developing, manufacturing, or selling products now covered by the patent(s) asserted in this case during the period of unreasonably long delay, whether other private parties have done so and may be potentially subject to infringement, and whether the time when the public will be able to freely practice the invention(s) now covered by the patent(s) asserted in this case was unduly and unfairly postponed as a result of delay.

You may also consider whether [patent holder] intentionally or deliberately delayed the time when it filed the claim(s) of the patent(s) and whether [alleged infringer] or the public was aware that patent applications were pending that did or potentially could have covered the invention.

Authorities

35 U.S.C. § 282; *Crown Cork & Seal Co. v. Ferdinand Gutmann Co.*, 304 U.S. 159 (1938); *Gen. Talking Pictures Corp. v. W. Elec. Co.*, 304 U.S. 175 (1938); *Webster Elec. Co. v. Splitdorf Elec. Co.*, 264 U.S. 463 (1924); *Woodbridge v. United States*, 263 U.S. 50 (1923); *Kendall v. Winsor*, 62 U.S. 322 (1859); *Symbol Techs., Inc. v. Lemelson Med., Educ. & Research Found., L.P.*, 277 F.3d 1361, 1363 (Fed. Cir. 2002) (“[T]he equitable doctrine of laches may be applied to bar enforcement of patent claims that issued after an unreasonable and unexplained delay in prosecution even though the applicant complied with pertinent statutes and rules.”); *Symbol Techs., Inc. v. Lemelson Med., Educ. & Research Found., L.P.*, 301 F. Supp. 2d 1147 (D. Nev. 2004) (patent claims unenforceable because eighteen- to thirty-nine-year delay in prosecuting patents was unreasonable and unjustified), *aff’d*, 422 F.3d 1378 (Fed. Cir. 2005); *see also In re Bogese II*, 303 F.3d 1362 (Fed. Cir. 2002) (affirming patent board’s order of forfeiture of patent rights after twelve continuation applications over eight-year period and failure to advance prosecution of application).

B.5. Equitable Defenses

5.5 UNCLEAN HANDS

The owner of a patent may be barred from enforcing the patent against an infringer where the owner of the patent acts or acted inequitably, unfairly, or deceitfully towards the infringer or the Court in a way that has immediate and necessary relation to the relief that the patent holder seeks in a lawsuit. This is referred to as “unclean hands,” and it is a defense that [alleged infringer] contends precludes any recovery by [patent holder] in this lawsuit.

You must consider and weigh all the facts and circumstances to determine whether you believe that, on balance, [patent holder] acted in such an unfair way towards [alleged infringer] or the Court in the matters relating to the controversy between [patent holder] and [alleged infringer] that, in fairness, [patent holder] should be denied the relief it seeks in this lawsuit. [Alleged infringer] must prove unclean hands by a preponderance of the evidence.

Authorities

35 U.S.C. § 282; *Keystone Driller Co. v. Gen. Excavator Co.*, 290 U.S. 240 (1933) (affirming dismissal of patent holder’s complaints for unclean hands from suppressing evidence of prior use in another litigation); *Aptix Corp. v. Quickturn Design Sys., Inc.*, 269 F.3d 1369 (Fed. Cir. 2001) (affirming district court’s finding of unclean hands when inventor added new material to signed and dated pages, but vacating judgment of unenforceability because unclean hands do not nullify grant of personal property).

B.6 Patent Damages

6.1 DAMAGES—INTRODUCTION

If you find that [alleged infringer] infringed any valid claim of the [] patent, you must then consider what amount of damages to award to [patent holder]. I will now instruct you about the measure of damages. By instructing you on damages, I am not suggesting which party should win this case, on any issue. If you find that [alleged infringer] has not infringed any valid claim of the patent, then [patent holder] is not entitled to any damages.

The damages you award must be adequate to compensate [patent holder] for the infringement. They are not meant to punish an infringer. Your damages award, if you reach this issue, should put [patent holder] in approximately the same financial position that it would have been in had the infringement not occurred.

[Patent holder] has the burden to establish the amount of its damages by a preponderance of the evidence. In other words, you should award only those damages that [patent holder] establishes that it more likely than not suffered. While [patent holder] is not required to prove the amount of its damages with mathematical precision, it must prove them with reasonable certainty. You may not award damages that are speculative, damages that are only possible, or damages that are based on guesswork.

There are different types of damages that [patent holder] may be entitled to recover. In this case, [patent holder] seeks [insert as appropriate, e.g., lost profits, price erosion, lost convoyed sales, or a reasonable royalty]. Lost profits consist of any actual reduction in business profits [patent holder] suffered as a result of [alleged infringer]'s infringement. A reasonable royalty is defined as the money amount [patent holder] and [alleged infringer] would have agreed upon as a fee for use of the invention at the time prior to when infringement began. But, regardless of the type of damages you may choose to award, you must be careful to ensure that award is no more or no less than the value of the patented invention.

[Add if patent holder is under a RAND obligation: Because [patent holder] committed to license the patent on Reasonable and Non-Discriminatory (“RAND”) terms, you must ensure that any damages award is consistent with and does not exceed the amount permitted under [patent holder's] RAND obligations.]

I will give more detailed instructions regarding damages shortly. Note, however, that [patent holder] is entitled to recover no less than a reasonable royalty for each infringing [sale; fill in other infringing act].

Committee Comments and Authorities

See 35 U.S.C. § 284; *Ericsson, Inc. v. D-Link Sys.*, 773 F.3d 1201, 1226 (Fed. Cir. 2014) (“What is taken from the owner of a utility patent (for purposes of assessing damages under § 284) is only the patented technology, and so the value to be measured is only the value of the infringing features of an accused product.”); *Virnetx, Inc. v. Cisco Sys., Inc.*, 767 F.3d 1308, 1326 (Fed. Cir. 2014) (“No matter what the form of the royalty, a patentee must take care to seek only those damages attributable to the infringing features.”); *Calico Brand, Inc. v. Ameritek Imps., Inc.*, 527

Fed. Appx. 987, 996 (Fed. Cir. 2013) (“lost profits must be tied to the intrinsic value of the patented feature”); *ResQNet.com, Inc. v. Lansa, Inc.*, 594 F.3d 860, 869 (Fed. Cir. 2010) (“the trial court must carefully tie proof of damages to the claimed invention’s footprint in the market place”); *Dow Chem. Co. v. Mee Indus., Inc.*, 341 F.3d 1370, 1381-82 (Fed. Cir. 2003); *Integra Lifesciences I, Ltd. v. Merck KGaA*, 331 F.3d 860, 870 (Fed. Cir. 2003); *Grain Processing Corp. v. Am. Maize-Prods. Co.*, 185 F.3d 1341, 1349 (Fed. Cir. 1999); *Maxwell v. J. Baker, Inc.*, 86 F.3d 1098, 1108-09 (Fed. Cir. 1996); *Rite-Hite Corp. v. Kelley Co.*, 56 F.3d 1538, 1545 (Fed. Cir. 1995) (en banc); *Lam, Inc. v. Johns-Manville Corp.*, 718 F.2d 1056, 1065 (Fed. Cir. 1983).

A patent holder is not entitled to damages that are remote or speculative. *See, e.g., Lucent Techs., Inc. v. Gateway, Inc.*, 580 F.3d 1301, 1340 (Fed. Cir. 2009) (vacating and remanding jury award as excessive); *Lam*, 718 F.2d at 1067 (holding that lost profits, as well as the harm to the goodwill of the entire market stemming from the infringer’s inferior product, were not remote or speculative, and thus recoverable). The Federal Circuit has opined, in *dicta*, that “remote consequences, such as a heart attack of the inventor or loss in value of shares of common stock of a patentee corporation caused indirectly by infringement are not compensable.” *Rite-Hite*, 56 F.3d at 1546. While a patent holder is not required to prove its damages with mathematical precision, it must prove them with reasonable certainty. *Standard Havens Prods., Inc. v. Gencor Indus., Inc.*, 953 F.2d 1360 (Fed. Cir. 1991).

When the amount of damages cannot be ascertained with precision, any doubts regarding the amount must be resolved against the alleged infringer. *Lam*, 718 F.2d at 1064. Any such adverse consequences must rest on the alleged infringer when the inability to ascertain lost profits is due to the infringer’s own failure to keep accurate records. *Id.*

B.6 Patent Damages

6.2 LOST PROFITS—“BUT FOR” TEST

[This instruction should only be given in the event the patent holder is seeking lost profits damages, in whole or in part.]

In this case, [patent holder] seeks to recover lost profits for some of [alleged infringer]’s sales of [infringing product], and a reasonable royalty on the rest of [alleged infringer]’s sales.

To recover lost profits (as opposed to reasonable royalties), [patent holder] must show a causal relationship between the infringement and [patent holder]’s loss of profit. In other words, [patent holder] must show that, but for the infringement, there is a reasonable probability that [patent holder] would have earned higher profits. To show this, [patent holder] must prove that, if there had been no infringement, [it would have made some portion of the sales that [alleged infringer] made of the infringing product,] [it would have sold more products that are functionally related to those products,] [it would have sold its products at higher prices,] [or it would have had lower costs].

[Patent holder] is entitled to lost profits if it establishes each of the following:

- (1) That there was a demand for the patented [product] [method] [product produced by the method].
- (2) That there were no available, acceptable, noninfringing substitute products, or, if there were, its market share of the number of the sales made by [alleged infringer] that [patent holder] would have made, despite the availability of other acceptable noninfringing substitutes.
- (3) That [patent holder] had the manufacturing and marketing capacity to make any infringing sales actually made by [alleged infringer] and for which [patent holder] seeks an award of lost profits—in other words, that [patent holder] was capable of satisfying the demand.
- (4) The amount of profit that [patent holder] would have made if [alleged infringer] had not infringed.

Committee Comments and Authorities

35 U.S.C. § 284; *Aro Mfg. Co. v. Convertible Top Co.*, 377 U.S. 476, 502-07 (1964); *Ericsson, Inc. v. Harris Corp.*, 352 F.3d 1369, 1377-79 (Fed. Cir. 2003); *Micro Chem., Inc. v. Lextron, Inc.*, 318 F.3d 1119, 1123 (Fed. Cir. 2003); *Gargoyles, Inc. v. United States*, 113 F.3d 1572, 1577-78 (Fed. Cir. 1997); *Rite-Hite Corp. v. Kelley Co.*, 56 F.3d 1538, 1545 (Fed. Cir. 1995) (en banc); *BIC Leisure Prods., Inc. v. Windsurfing Int’l, Inc.*, 1 F.3d 1214, 1218-19 (Fed. Cir. 1993); *Carella v. Starlight Archery*, 804 F.2d 135, 141 (Fed. Cir. 1986); *Gyromat Corp. v. Champion Spark Plug Co.*, 735 F.2d 549, 552 (Fed. Cir. 1984); *Panduit Corp. v. Stahl Bros. Fibre Works, Inc.*, 575 F.2d 1152, 1156 (6th Cir. 1978).

The four-factor “but for” test was first articulated in *Panduit*, 575 F.2d at 1156, and has since been adopted by the Federal Circuit. *See, e.g., Rite-Hite*, 56 F.3d at 1545. It is not, however, the only available method for proving lost profits. *Id.*; *see also BIC*, 1 F.3d at 1218-19.

Once a patent holder has shown the four elements of the *Panduit* test, the burden then shifts to alleged infringer to show that patent holder’s “but for” causation analysis is unreasonable under the specific circumstances. *Rite-Hite*, 56 F.3d at 1545.

LOST PROFITS—DEMAND

Demand for the patented product can be proven by significant sales of a patent holder’s patented product or significant sales of an infringing product containing the patented features.

Authorities

DePuy Spine, Inc. v. Medtronic Sofamor Danek, Inc., 567 F.3d 1314, 1330 (Fed. Cir. 2009).

LOST PROFITS—NONINFRINGEMENT SUBSTITUTES—ACCEPTABILITY

To be an “acceptable, [noninfringing] substitute,” a product must have the advantages of the patented invention that were important to people who purchased an alleged infringer’s product. If purchasers of an alleged infringer’s product were motivated to buy that product because of features available only from that product and a patent holder’s patented product, then some other, alternative product is not an acceptable substitute, even if it otherwise competed with a patent holder’s and an alleged infringer’s products. On the other hand, if the realities of the marketplace are that competitors other than the patentee would likely have captured the sales made by the infringer, despite a difference in the products, then the patentee is not entitled to lost profits on those sales.

Authorities

Am. Seating Co. v. USSC Group, 514 F.3d 1262, 1270 (Fed. Cir. 2008) (“[B]uyers must view the substitute as equivalent to the patented device.”); *Standard Havens Prods., Inc. v. Gencor Indus.*, 953 F.2d 1360, 1373 (Fed. Cir. 1991); *SmithKline Diagnostics, Inc. v. Helena Lab. Corp.*, 926 F.2d 1161, 1166 (Fed. Cir. 1991).

LOST PROFITS—NONINFRINGEMENT SUBSTITUTES—AVAILABILITY

An alternative product may be considered “available” as a potential substitute even if the product was not actually on sale during the infringement period. Factors suggesting the alternative was available include whether the material, experience, and know-how for the alleged substitute were readily available at the time of infringement. Factors suggesting the alternative was not available include whether the material was of such high cost as to render the alternative unavailable and whether an alleged infringer had to design or invent around the patented technology to develop an alleged substitute.

Authorities

Grain Processing Corp. v. Am. Maize-Prods. Co., 185 F.3d 1341, 1349 (Fed. Cir. 1999) (holding that an unused, but available, noninfringing process was an acceptable substitute); *Micro Chem., Inc. v. Lextron, Inc.*, 318 F.3d 1119, 1123 (Fed. Cir. 2003) (“The record shows that Lextron did not have the necessary equipment, know-how, and experience to make the [alternative] machine at the time of infringement.”).

LOST PROFITS—CAPACITY

A patent holder is only entitled to lost profits for sales it could have actually made. In other words, [patent holder] must show that it had the manufacturing and marketing capability to make the sales it said it lost. This means [patent holder] must prove it is more probable than not that it could have made and sold, or could have had someone else make or sell for it, the additional products it says it could have sold but for the infringement.

Authorities

Fonar Corp. v. Gen. Elec. Co., 107 F.3d 1543, 1553 (Fed. Cir. 1997) (finding that the patent holder, a young company, would have expanded to meet the increased demand created by the success of the patented product); *Gyromat Corp. v. Champion Spark Plug Co.*, 735 F.2d 549, 554 (Fed. Cir. 1984).

LOST PROFITS—AMOUNT OF PROFIT

A patent holder may calculate its lost profits on lost sales by computing the lost revenue for sales it claims it would have made but for the infringement and subtracting from that figure the amount of additional costs or expenses it would have incurred in making those lost sales, such as cost of goods, sales costs, packaging costs, and shipping costs. Certain fixed costs that do not vary with increases in production or scale, such as taxes, insurance, rent, and administrative overhead, should not be subtracted from a patent holder's lost revenue.

Authorities

Paper Converting Mach. Co. v. Magna-Graphics Corp., 745 F.2d 11 (Fed. Cir. 1984).

LOST PROFITS—MARKET SHARE

If a patent holder establishes it would have made some, but not all, of an alleged infringer's sales but for the infringement, the amount of sales that the patent holder lost may be shown by proving the patent holder's share of the relevant market, excluding infringing products. A patent holder may be awarded a share of profits equal to its market share even if there were noninfringing substitutes available. In determining a patent holder's market share, the market must be established first, which requires determining which products are in that market. Products are considered in the same market if they are considered "sufficiently similar" to compete against each other. Two products are sufficiently similar if one does not have a significantly higher price than, or possess characteristics significantly different from, the other.

Authorities

State Indus., Inc. v. Mor-Flo Indus., Inc., 883 F.2d 1573, 1557 (Fed. Cir. 1989); *BIC Leisure Prods., Inc. v. Windsurfing Int'l, Inc.*, 1 F.3d 1214, 1218-19 (Fed. Cir. 1993); *Micro Chem., Inc. v. Lextron, Inc.*, 318 F.3d 1119, 1124 (Fed. Cir. 2003); *Crystal Semiconductor Corp. v. Tritech Microelectronics Int'l, Inc.*, 246 F.3d 1336, 1354-55 (Fed. Cir. 2001).

B.6 Patent Damages

6.3 LOST PROFITS—COLLATERAL SALES

[This instruction should only be given in the event that patent holder is seeking lost profits from collateral sales.]

In this case, [patent holder] is seeking lost profits from sales of [], which [patent holder] contends it would have sold along with the product it sells that competes with the infringing products []. These products sold along with the competitive product are called collateral products.

To recover lost profits on sales of such collateral products, [patent holder] must establish two things. First, [patent holder] must establish it is more likely than not that [patent holder] would have sold the collateral products but for the infringement. Second, a collateral product and the competitive product together must be analogous to components of a single assembly or parts of a complete machine, or, in other words, they must constitute a single functional unit.

Recovery for lost profits on sales of collateral products must not include items that essentially have no functional relationship to the competitive product and that have been sold with the competitive product only as a matter of convenience or business advantage.

Committee Comments and Authorities

The relationship required to recover lost profits on collateral sales is outlined in *Rite-Hite Corp. v. Kelley Co.*, 56 F.3d 1538, 1550 (Fed. Cir. 1995) (en banc) (denying recovery for lost profits on collateral sales where nonpatented product lacked a functional relationship to the patented product); *see also State Indus., Inc. v. Mar-Flo Indus., Inc.*, 883 F.2d 1573, 1580 (Fed. Cir. 1989); *Panduit Corp. v. Stahl Bros. Fibre Works, Inc.*, 575 F.2d 1152, 1157-58 (6th Cir. 1978).

B.6 Patent Damages

6.4 LOST PROFITS—PRICE EROSION

[This instruction should only be given in the event that patent holder contends it should be compensated for price erosion.]

[Patent holder] can recover additional damages if it can establish that it is more likely than not that, if there had been no infringement, [patent holder] would have been able to charge higher prices for some of its products. If this fact is established, you may award as additional damages the difference between:

- (A) the amount of profits [patent holder] would have made by selling its product at the higher price, and
- (B) the amount of profits [patent holder] actually made by selling its product at the lower price [patent holder] actually charged for its product.

This type of damage is referred to as price-erosion damage.

If you find that [patent holder] suffered price erosion, you may also use the higher price in determining [patent holder]'s lost profits from sales that were lost because of the infringement. In calculating [patent holder]'s total losses from price erosion, you must take into account any drop in sales that would have resulted from charging a higher price.

You may also award as damages the amount of any increase in [patent holder]'s costs, such as additional marketing costs, caused by competition from the infringing product.

Authorities

Compare Crystal Semiconductor Corp. v. Tritech Microelectronics Int'l, Inc., 246 F.3d 1336, 1357-58 (Fed. Cir. 2001) (upholding denial of price-erosion damages where patentee failed to show how higher prices would have affected demand for the patented product), *with Ericsson, Inc. v. Harris Corp.*, 352 F.3d 1369, 1377-79 (Fed. Cir. 2003) (upholding award of price-erosion damages where patentee offered sufficient proof of an inelastic market that would support price increases without a drop in sales of the patented product); *see also Vulcan Eng'g Co. v. FATA Aluminum, Inc.*, 278 F.3d 1366, 1377 (Fed. Cir. 2002); *Minco, Inc. v. Combustion Eng'g, Inc.*, 95 F.3d 1109, 1120 (Fed. Cir. 1996); *BIC Leisure Prods., Inc. v. Windsurfing Int'l, Inc.*, 1 F.3d 1214, 1220 (Fed. Cir. 1993); *Kalman v. Berlyn Corp.*, 914 F.2d 1473, 1485 (Fed. Cir. 1990).

B.6 Patent Damages

6.5 REASONABLE ROYALTY—ENTITLEMENT

If you find that [patent holder] has established infringement, [patent holder] is entitled to at least a reasonable royalty to compensate it for that infringement. If you find that [patent holder] has not proved its claim for lost profits, or has proved its claim for lost profits for only a portion of the infringing sales, then you must award [patent holder] a reasonable royalty for all infringing sales for which it has not been awarded lost profits damages.

Authorities

35 U.S.C. § 284; *Lucent Techs., Inc. v. Gateway, Inc.*, 580 F.3d 1301, 1340 (Fed. Cir. 2009) (vacating and remanding jury award as excessive); *Crystal Semiconductor Corp. v. Tritech Microelectronics Int'l, Inc.*, 246 F.3d 1336 (Fed. Cir. 2001); *Fromson v. W. Litho Plate & Supply Co.*, 853 F.2d 1568, 1574 (Fed. Cir. 1998); *Minco, Inc. v. Combustion Eng'g, Inc.*, 95 F.3d 1109, 1119-20 (Fed. Cir. 1996); *Mahurkar v. C.R. Bard, Inc.*, 79 F.3d 1572, 1579 (Fed. Cir. 1996); *Rite-Hite Corp. v. Kelley Co.*, 56 F.3d 1538, 1554 (Fed. Cir. 1995) (en banc).

B.6 Patent Damages

6.6 REASONABLE ROYALTY—DEFINITION

A royalty is a payment made to a patent holder in exchange for the right to make, use, or sell the claimed invention. A reasonable royalty is the amount of royalty payment that a patent holder and the alleged infringer would have agreed to in a hypothetical negotiation taking place at a time prior to when the infringement first began. In considering this hypothetical negotiation, you should focus on what the expectations of the patent holder and the alleged infringer would have been had they entered into an agreement at that time, and had they acted reasonably in their negotiations. In determining this, you must assume that both parties believed the patent was valid and infringed and that both parties were willing to enter into an agreement. The reasonable royalty you determine must be a royalty that would have resulted from the hypothetical negotiation, and not simply a royalty either party would have preferred. Evidence of things that happened after the infringement first began can be considered in evaluating the reasonable royalty only to the extent that the evidence aids in assessing what royalty would have resulted from a hypothetical negotiation. Although evidence of the actual profits an alleged infringer made may be used to determine the anticipated profits at the time of the hypothetical negotiation, the royalty may not be limited or increased based on the actual profits the alleged infringer made.

Authorities

Uniloc USA, Inc. v. Microsoft Corp., 632 F.3d 1292 (Fed. Cir. 2011) (25% “rule of thumb” inadmissible); *ResQNet.com, Inc. v. Lansa, Inc.*, 594 F.3d 860 (Fed. Cir. 2010) (per curiam) (licenses must be related to patent at issue to be relevant to a reasonable royalty); *Lucent Techs., Inc. v. Gateway, Inc.*, 580 F.3d 1301, 1340 (Fed. Cir. 2009) cert. denied, 130 S. Ct. 3324 (2010) (vacating and rewarding jury award as excessive); *Golight, Inc. v. Wal-Mart Stores, Inc.*, 355 F.3d 1327, 1338 (Fed. Cir. 2004); *Maxwell v. J. Baker, Inc.*, 86 F.3d 1098, 1108-10 (Fed. Cir. 1996); *Mahurkar v. C.R. Bard, Inc.*, 79 F.3d 1572, 1579-81 (Fed. Cir. 1996); *Rite-Hite Corp. v. Kelley Co.*, 56 F.3d 1538, 1554 (Fed. Cir. 1995) (en banc); *Georgia-Pacific Corp. v. U.S. Plywood Corp.*, 318 F. Supp. 1116, 1120 (S.D.N.Y. 1970); *Interactive Pictures Corp. v. Infinite Pictures, Inc.*, 274 F.3d 1371 (Fed. Cir. 2001); *Trans-World Mfg. Corp. v. Al Nyman & Sons, Inc.*, 750 F.2d 1552 (Fed. Cir. 1984).

B.6 Patent Damages

6.7 REASONABLE ROYALTY—RELEVANT FACTORS

In determining the reasonable royalty, you should consider all the facts known and available to the parties at the time the infringement began. Some of the kinds of factors that you may consider in making your determination are:

- (1) The value that the claimed invention contributes to the accused product.
- (2) The value that factors other than the claimed invention contribute to [the accused product].
- (3) Comparable license agreements, such as those covering the use of the claimed invention or similar technology.

[Add if a Standard Essential Patent or a patent otherwise subject to a RAND obligation is involved] You have heard evidence that the asserted patent is a standard essential patent, that is, the [industry standard] cannot be practiced without infringing the patent. If you agree that the patent is essential to the [standard], you must ensure that your damages award reflects only the value of the patented invention and not the additional value that resulted from the patent's inclusion in the [standard]. In other words, you may not consider the success of the standard itself in determining a reasonable royalty for the patent(s)-in-suit.]

No one factor is dispositive and you can and should consider the evidence that has been presented to you in this case on each of these factors. You may also consider any other factors which in your mind would have increased or decreased the royalty the alleged infringer would have been willing to pay and the patent holder would have been willing to accept, acting as normally prudent business people.

Committee Comments and Authorities

The so-called “*Georgia-Pacific*” factors, which can be considered in appropriate cases to inform the hypothetical negotiations, include the following:

- (1) The royalties received by the patentee for the licensing of the patent-in-suit, proving or tending to prove an established royalty
- (2) The rates paid by the licensee for the use of other patents comparable to the patent-in-suit.
- (3) The nature and scope of the license, as exclusive or nonexclusive, or as restricted or nonrestricted in terms of territory or with respect to whom the manufactured product may be sold.

- (4) The licensor's established policy and marketing program to maintain his or her patent monopoly by not licensing others to use the invention or by granting licenses under special conditions designed to preserve that monopoly.
- (5) The commercial relationship between the licensor and licensee, such as whether they are competitors in the same territory in the same line of business, or whether they are inventor and promoter.
- (6) The effect of selling the patented specialty in promoting sales of other products of the licensee, the existing value of the invention to the licensor as a generator of sales of his nonpatented items, and the extent of such derivative or convoyed sales.
- (7) The duration of the patent and the term of the license.
- (8) The established profitability of the product made under the patents, its commercial success, and its current popularity.
- (9) The utility and advantages of the patented property over the old modes or devices, if any, that had been used for working out similar results.
- (10) The nature of the patented invention, the character of the commercial embodiment of it as owned and produced by the licensor, and the benefits to those who have used the invention.
- (11) The extent to which the infringer has made use of the invention and any evidence probative of the value of that use.
- (12) The portion of the profit or of the selling price that may be customary in the particular business or in comparable business to allow for the use of the invention or analogous inventions.
- (13) The portion of the realizable profits that should be credited to the invention as distinguished from nonpatented elements, the manufacturing process, business risks, or significant features or improvements added by the infringer.
- (14) The opinion and testimony of qualified experts.
- (15) The amount that a licensor (such as the patentee) and a licensee (such as the infringer) would have agreed upon (at the time the infringement began) if both had been reasonably and voluntarily trying to reach an agreement; that is, the amount which a prudent licensee—who desired, as a business proposition, to obtain a license to manufacture and sell a particular article embodying the patented invention—would have been willing to pay as a royalty and yet be able to make a reasonable profit and which amount would have been acceptable by a prudent patentee who was willing to grant a license.

The Federal Circuit has made it clear that the *Georgia Pacific* factors are not mandatory. *See, e.g., Energy Transp. Group, Inc. v. William Demant Holding A/S*, 697 F.3d 1342, 1357 (Fed. Cir. 2012) (“[T]his court does not endorse *Georgia-Pacific* as setting forth a test for royalty

calculations, but only as a list of admissible factors informing a reliable economic analysis.”). But if they are used, the jury should be instructed only on the factors that are relevant to the evidence before the jury. *Ericsson, Inc. v. D-Link Sys.*, 773 F.3d 1201, 1231 (Fed. Cir. 2014) (stating that “the district court erred by instructing the jury on multiple *Georgia-Pacific* factors that are not relevant, or are misleading, on the record before it”); *Uniloc USA, Inc. v. Microsoft Corp.*, 632 F.3d 1292 (Fed. Cir. 2011) (25% “rule of thumb” inadmissible); *ResQNet.com, Inc. v. Lansa, Inc.*, 594 F.3d 860 (Fed. Cir. 2010) (per curiam) (licenses must be related to patent at issue to be relevant to a reasonable royalty); *Lucent Techs., Inc. v. Gateway, Inc.*, 580 F.3d 1301, 1340 (Fed. Cir. 2009), cert. denied, 130 S. Ct. 3324 (2010) (vacating and rewarding jury award as excessive); *Golight, Inc. v. Wal-Mart Stores, Inc.*, 355 F.3d 1327, 1338 (Fed. Cir. 2004); *Maxwell v. J. Baker, Inc.*, 86 F.3d 1098, 1108-10 (Fed. Cir. 1996); *Mahurkar v. C.R. Bard, Inc.*, 79 F.3d 1572, 1579-81 (Fed. Cir. 1996); *Rite-Hite Corp. v. Kelley Co.*, 56 F.3d 1538, 1554 (Fed. Cir. 1995) (en banc); *Georgia-Pacific Corp. v. U.S. Plywood Corp.*, 318 F. Supp. 1116, 1120 (S.D.N.Y. 1970).

If a Standard Essential Patent is involved, the jury must be instructed to separate out the value of the patented invention from any value that arises from the fact that the patent is essential to a standard:

Because SEP holders should only be compensated for the added benefit of their inventions, the jury must be told to differentiate the added benefit from any value the innovation gains because it has become standard essential. Although the jury, as the fact finder, should determine the appropriate value for that added benefit and may do so with some level of imprecision, we conclude that they must be told to consider the difference between the added value of the technological invention and the added value of that invention's standardization.

Ericsson, Inc. v. D-Link Sys., 773 F.3d at 1233.

B.6 Patent Damages

6.8 DATE OF COMMENCEMENT OF DAMAGES—PRODUCTS

In determining the amount of damages, you must determine when the damages began. Damages commence on the date that [alleged infringer] has both infringed and been notified of the alleged infringement of the [] patent [choose those that apply]:

Alternative A:

[Patent holder] and [alleged infringer] agree that date was [insert date].

Alternative B:

If you find that [patent holder] sells a product that includes the claimed invention, you must determine whether [patent holder] has “marked” that product with the patent number. “Marking” is placing either the word “patent” or the abbreviation “pat.” with the patent’s number on substantially all of the products that include the patented invention. [Patent holder] has the burden of establishing that it substantially complied with the marking requirement. This means [patent holder] must show that it marked substantially all of the products it made, offered for sale, or sold under the [] patent, [and that [patent holder] made reasonable efforts to ensure that its licensees who made, offered for sale, or sold products under the [] patent marked the products].

[If [patent holder] has not marked that product with the patent number, you must determine the date that [alleged infringer] received actual notice of the [] patent and the specific product alleged to infringe.] [Actual notice means that [patent holder] communicated to [alleged infringer] a specific charge of infringement of the [] patent by a specific accused product or device. The filing of the complaint in this case qualified as actual notice, so the damages period begins no later than the date the complaint was filed.] [However, [patent holder] claims to have provided actual notice prior to filing of the complaint, on [date], when it [sent a letter to [alleged infringer]].] [Patent holder] has the burden of establishing that it is more probable than not [alleged infringer] received notice of infringement on [date].]

[If you find that [patent holder] [chose A] does not sell a product covered by the [] patent [or chose B] sells such a product but marks the product with the patent number, damages begin without the requirement for actual notice. If you find that the [] patent was granted before the infringing activity began, damages should be calculated as of the date you determine that the infringement began. If you find that the [] patent was granted after the infringing activity began, damages should be calculated as of [date patent issued].]

Committee Comments and Authorities

35 U.S.C. § 287; *Crystal Semiconductor Corp. v. Tritech Microelectronics Int’l, Inc.*, 246 F.3d 1336 (Fed. Cir. 2001); *Nike Inc. v. Wal-Mart Stores*, 138 F.3d 1437, 1443-44 (Fed. Cir. 1998); *Maxwell v. J. Baker, Inc.*, 86 F.3d 1098, 1108-09 (Fed. Cir. 1996); *Am. Med. Sys. v. Med. Eng’g Corp.*, 6 F.3d 1523, 1534 (Fed. Cir. 1993); *Devices for Med., Inc. v. Boehl*, 822 F.2d 1062, 1066 (Fed. Cir. 1987).

Notice through marking is constructive notice. See *Maxwell*, 86 F.3d at 1111-12 (holding that when 95% of patented product offered for sale was marked by licensee retailer with “patent

pending,” even after the patent had been granted and remaining 5% of product remained unmarked, constructive notice had been made under 35 U.S.C. § 287(a) where patentee demonstrated efforts to correct licensee’s mistakes).

In determining when damages begin with regard to method claims, there is no notice requirement. 35 U.S.C. § 287(c)(2)(F); *see Am. Med. Sys.*, 6 F.3d at 1538 (“The law is clear that the notice provisions of section 287 do not apply where the patent is directed to a process or method.”). Accordingly, the calculation of damages for infringement of method claims should begin as of the date the patent issued or the date the infringement began, whichever was first. *Crystal Semiconductor*, 246 F.3d at 1353.

C. Appendix

GLOSSARY

Some of the terms in this glossary will be defined in more detail in the legal instructions you are given. The definitions in the instructions must be followed and must control your deliberations.

[Add any technical terms from the art involved that may be used during trial and have agreed upon definitions. Delete any of the following terms which may not be applicable in a particular case.]

Abstract: A brief summary of the technical disclosure in a patent to enable the U.S. Patent and Trademark Office and the public to determine quickly the nature and gist of the technical disclosure in the patent.

Amendment: A patent applicant's change to one or more claims or to the specification either in response to an office action taken by an Examiner or independently by the patent applicant during the patent application examination process.

Anticipation: A situation in which a claimed invention describes an earlier invention and, therefore, is not considered new and is not entitled to be patented.

Assignment: A transfer of patent rights to another called an "assignee" who, upon transfer, becomes the owner of the rights assigned.

Claim: Each claim of a patent is a concise, formal definition of an invention and appears at the end of the specification in a separately numbered paragraph. In concept, a patent claim marks the boundaries of the patent in the same way that a legal description in a deed specifies the boundaries of land, i.e., similar to a landowner who can prevent others from trespassing on the bounded property, the inventor can prevent others from using what is claimed. Claims may be independent or dependent. An independent claim stands alone. A dependent claim does not stand alone and refers to one or more other claims. A dependent claim incorporates whatever the other referenced claim or claims say.

Conception: The complete mental part of the inventive act which must be capable of proof, as by drawings, disclosure to another, etc.

Drawings: The drawings are visual representations of the claimed invention contained in a patent application and issued patent, and usually include several figures illustrating various aspects of the claimed invention.

Elements: The required parts of a device or the required steps of a method. A device or method infringes a patent if it contains each and every requirement of a patent claim.

Embodiment: A product or method that contains the claimed invention.

Enablement: A description of the invention that is sufficient to enable persons skilled in the field of the invention to make and use the invention. The specification of the patent must contain such an enabling description.

Examination: Procedure before the U.S. Patent and Trademark Office whereby an Examiner reviews the filed patent application to determine if the claimed invention is patentable.

Filing Date: Date a patent application, with all the required sections, has been submitted to the U.S. Patent and Trademark Office.

Infringement: Violation of a patent occurring when someone makes, uses, or sells a patented invention, without permission of the patent holder, within the United States during the term of the patent. Infringement may be direct, by inducement, or contributory. Direct infringement is making, using, or selling the patented invention without permission. Inducing infringement is intentionally causing another to directly infringe a patent. Contributory infringement is offering to sell or selling an item that is a significant part of the invention, so that the buyer directly infringes the patent. To be a contributory infringer, one must know that the part being offered or sold is designed specifically for infringing the patented invention and is not a common object suitable for noninfringing uses.

Limitation: A required part of an invention set forth in a patent claim. A limitation is a requirement of the invention. The word "limitation" is often used interchangeably with the word "requirement."

Nonobviousness: One of the requirements for securing a patent. To be valid, the subject matter of the invention must not have been obvious to a person of ordinary skill in the field at the time of the earlier of the filing date of the patent application or the date of invention.

Office Action: A written communication from the Examiner to the patent applicant in the course of the application examination process.

Patent: A patent is an exclusive right granted by the U.S. Patent and Trademark Office to an inventor to prevent others from making, using, or selling an invention for a term of 20 years from the date the patent application was filed (or 17 years from the date the patent issued). When the patent expires, the right to make, use, or sell the invention is dedicated to the public. The patent has three parts, which are a specification, drawings and claims. The patent is granted after examination by the U.S. Patent and Trademark Office of a patent application filed by the inventor which has these parts, and this examination is called the prosecution history.

Patent and Trademark Office (PTO): An administrative branch of the U.S. Department of Commerce that is charged with overseeing and implementing the federal laws of patents and trademarks. It is responsible for examining all patent applications and issuing all patents in the United States.

Prior Art: Previously known subject matter in the field of a claimed invention for which a patent is being sought. It includes issued patents, publications, and knowledge deemed to be publicly available, such as trade skills, trade practices, and the like.

Prosecution History: The prosecution history is the complete written record of the proceedings in the PTO from the initial application to the issued patent. The prosecution history includes the office actions taken by the PTO and the amendments to the patent application filed by the applicant during the examination process.

Reads On: A patent claim “reads on” a device or method when each required part (requirement) of the claim is found in the device or method.

Reduction to Practice: The invention is “reduced to practice” when it is sufficiently developed to show that it would work for its intended purpose.

Requirement: A required part or step of an invention set forth in a patent claim. The word “requirement” is often used interchangeably with the word “limitation.”

Royalty: A royalty is a payment made to the owner of a patent by a nonowner in exchange for rights to make, use, or sell the claimed invention.

Specification: The specification is a required part of a patent application and an issued patent. It is a written description of the invention and of the manner and process of making and using the claimed invention.

**Model Patent Jury Instructions
for the Northern District of California**

June 17, 2014

Working Committee

Professor Mark Lemley
Kathi Lutton David McIntyre Matthew Powers
Honorable Ronald Whyte
James Yoon

I. Introduction

These Model Patent Jury Instructions have been adopted by the Northern District of California and have been revised to account for changes in the law as of June 1, 2014. However, several patent cases are pending before the Supreme Court and further modifications may be required.

Additionally, Congress has amended the patent laws in the America Invents Act (“AIA”), signed by the President on September 16, 2011. Most notably, the First Inventor to File Provision of the AIA redefines Prior Art for those patent applications filed under the First Inventor to File system. The prior art jury instructions provided in this model set of instructions are therefore inapplicable to any claimed invention having an effective filing date on or after March 16, 2013.

The court is indebted to the Working Committee which spent many hours drafting the original model instructions and subsequent revisions. The court specially recognizes the contributions of Martin Fleisler who acted as chair of the Committee prior to his recent passing.

The instructions have been prepared to assist judges in communicating effectively and in plain English with jurors in patent cases. The instructions are models and are not intended to be used without tailoring. They are not substitutes for the individual research and drafting that may be required in a particular case.

These instructions include only instructions on patent law. They will need to be supplemented with standard instructions on, among other things, the duties of the judge and jury, the consideration of evidence, the duty to deliberate, and the return of a verdict. The Ninth Circuit’s Manual of Model Civil Jury Instructions (download from [Civil_Jury_Instructions_2014.pdf](#) or [Civil_Jury_Instructions_2014.wpd](#)) is a good reference for standard instructions for civil cases.

The instructions use the terms “patent holder” and “alleged infringer” in brackets. The names of the parties should be substituted for these terms as appropriate. Other language is bracketed as it may not be appropriate for a particular case. Empty brackets signify additional case specific information to be added, such as patent or claim numbers.

Suggested revisions to these instructions may be sent to the Honorable Ronald M. Whyte at the e-mail address: Ronald_Whyte@cand.uscourts.gov or at his U.S. mail address: U.S. Court Building, 280 S. First Street, San Jose, California 95113.

June 17, 2014

II. Table of Contents

- A. Preliminary Instructions
 - 1. What a Patent Is and How One is Obtained
 - 2. Patent At Issue
 - 3. Summary of Contentions
 - 4. Overview of Applicable Law
 - 5. Outline of Trial
- B. Instructions at Close of Evidence
 - 1. Summary of Contentions
 - 2. Claim Construction
 - 2.1 Interpretation of Claims
 - 3. Infringement
 - 3.1 Infringement – Burden of Proof
 - 3.2 Direct Infringement
 - 3.3 Literal Infringement
 - 3.4 Infringement Under the Doctrine of Equivalents
 - 3.5 Means-Plus-Function Claims – Literal Infringement
 - 3.6 Means-Plus-Function Claims – Infringement Under the Doctrine of Equivalents
 - 3.7 Limitations on the Doctrine of Equivalents
 - 3.8 Contributory Infringement
 - 3.9 Inducing Patent Infringement
 - 3.10 Willful Infringement
 - 4. Validity
 - 4.1 Invalidity – Burden of Proof
 - 4.2 Adequacy of Patent Specification
 - 4.2a Written Description
 - 4.2b Enablement
 - 4.2c Best Mode
 - 4.3 The Claims
 - 4.3a1 Anticipation
 - 4.3a2 Statutory Bars
 - 4.3b Obviousness – (Alternative 1) – (Alternative 2)
 - 4.3c Inventorship
 - 5. Patent Damages
 - 5.1 Damages – Burden of Proof
 - 5.2 Lost Profits – Generally
 - 5.3 Lost Profits – Factors to Consider
 - 5.3a Lost Profits – Market Share
 - 5.4 Lost Profits – Collateral Sales
 - 5.5 Lost Profits – Price Erosion
 - 5.6 Reasonable Royalty – Entitlement
 - 5.7 Reasonable Royalty – Definition
 - 5.8 Date of Commencement – Products

5.9 Calculating Damages in Cases of Inducement or Contributory Infringement

C. Appendix

1. Glossary
2. Comments Regarding Use of Sample Verdict Form
3. Sample Verdict Form

A.1. Preliminary Instructions

WHAT A PATENT IS AND HOW ONE IS OBTAINED

This case involves a dispute relating to a United States patent. Before summarizing the positions of the parties and the legal issues involved in the dispute, let me take a moment to explain what a patent is and how one is obtained.

Patents are granted by the United States Patent and Trademark Office (sometimes called “the PTO”). The process of obtaining a patent is called patent prosecution. A valid United States patent gives the patent owner the right to prevent others from making, using, offering to sell, or selling the patented invention within the United States, or from importing it into the United States, during the term of the patent without the patent holder’s permission. A violation of the patent owner’s rights is called infringement. The patent owner may try to enforce a patent against persons believed to be infringers by a lawsuit filed in federal court.

To obtain a patent one must file an application with the PTO. The PTO is an agency of the federal government and employs trained examiners who review applications for patents. The application includes what is called a “specification,” which must contain a written description of the claimed invention telling what the invention is, how it works, how to make it and how to use it so others skilled in the field will know how to make or use it. The specification concludes with one or more numbered sentences. These are the patent “claims.” When the patent is eventually granted by the PTO, the claims define the boundaries of its protection and give notice to the public of those boundaries.

After the applicant files the application, a PTO patent examiner reviews the patent application to determine whether the claims are patentable and whether the specification adequately describes the invention claimed. In examining a patent application, the patent examiner reviews records available to the PTO for what is referred to as “prior art.” The examiner also will review prior art if it is submitted to the PTO by the applicant. Prior art is defined by law, and I will give you at a later time specific instructions as to what constitutes prior art. [However, in general, prior art includes things that existed before the claimed invention, that were publicly known, or used in a publicly accessible way in this country, or that were patented or described in a publication in any country. The examiner considers, among other things, whether each claim defines an invention that is new, useful, and not obvious in view of the prior art.]* A patent lists the prior art that the examiner considered; this list is called the “cited references.”

* The preceding two sentences are inapplicable to any post-AIA claims, i.e., to any claimed invention having an effective filing date on or after March 16, 2013.

Appendix E: Model Patent Jury Instructions

After the prior art search and examination of the application, the patent examiner then informs the applicant in writing what the examiner has found and whether any claim is patentable, and thus will be “allowed.” This writing from the patent examiner is called an “office action.” If the examiner rejects the claims, the applicant then responds and sometimes changes the claims or submits new claims. This process, which takes place only between the examiner and the patent applicant, may go back and forth for some time until the examiner is satisfied that the application and claims meet the requirements for a patent. The papers generated during this time of communicating back and forth between the patent examiner and the applicant make up what is called the “prosecution history.” All of this material becomes available to the public no later than the date when the patent issues.

The fact that the PTO grants a patent does not necessarily mean that any invention claimed in the patent, in fact, deserves the protection of a patent. For example, the PTO may not have had available to it all the information that will be presented to you. A person accused of infringement has the right to argue here in federal court that a claimed invention in the patent is invalid because it does not meet the requirements for a patent.

A.2. Preliminary Instructions

PATENT AT ISSUE

[The court should show the jury the patent at issue and point out the parts including the specification, drawings and claims including the claims at issue.]

A.3. Preliminary Instructions

SUMMARY OF CONTENTIONS

To help you follow the evidence, I will now give you a summary of the positions of the parties.

The parties in this case are [patent holder] and [alleged infringer]. The case involves a United States patent obtained by [inventor], and transferred by [inventor] to [patent holder]. The patent involved in this case is United States Patent Number [patent number] which lists [inventor] as the inventor. For convenience, the parties and I will often refer to this patent as the [last three numbers of the patent] patent, [last three numbers of patent] being the last three numbers of its patent number.

[Patent holder] filed suit in this court seeking money damages from [alleged infringer] for allegedly infringing the [] patent by [making], [importing], [using], [selling], and [offering for sale] [products] [methods] that [patent holder] argues are covered by claims [] of the patent. [[Patent holder] also argues that [alleged infringer] has [actively induced infringement of these claims of the [] patent by others] [and] [contributed to the infringement of these claims of the [] patent by others].] The [products] [methods] that are alleged to infringe are [list of accused products or methods].

[Alleged infringer] denies that it has infringed claims [] of the [] patent and argues that, in addition, the claims are invalid. [Add other defenses, if applicable]. Invalidity is a defense to infringement.

Your job will be to decide whether claims [] of the [] patent have been infringed and whether those claims are invalid. If you decide that any claim of the [] patent has been infringed and is not invalid, you will then need to decide any money damages to be awarded to [patent holder] to compensate it for the infringement. [You will also need to make a finding as to whether the infringement was willful. If you decide that any infringement was willful, that decision should not affect any damage award you give. I will take willfulness into account later.]

You may hear evidence that [alleged infringer] has its own patent(s) or that [alleged infringer] improved on the [] patent. While this evidence is relevant to some issues you will be asked to decide, a party can still infringe even if it has its own patents in the same area. You will be instructed after trial as to what, if any, relevance these facts have to the particular issues in this case. Meanwhile, please keep an open mind.

Before you decide whether [alleged infringer] has infringed the claim[s] of the patent or whether the claim[s] [is][are] invalid, you will need to understand the patent claims. As I mentioned, the patent claims are numbered sentences at the end of the

patent that describe the boundaries of the patent's protection. It is my job as judge to explain to you the meaning of any language in the claim[s] that needs interpretation.

[The Court may wish to hand out its claim constructions (if the claims have been construed at this point) and the glossary at this time. If the claim constructions are handed out, the following instruction should be read:

I have already determined the meaning of certain terms of the claims of the [] patent. You have been given a document reflecting those meanings. You are to apply my definitions of these terms throughout this case. However, my interpretation of the language of the claims should not be taken as an indication that I have a view regarding issues such as infringement and invalidity. Those issues are yours to decide. I will provide you with more detailed instructions on the meaning of the claims before you retire to deliberate your verdict.]

A.4. Preliminary Instructions

OVERVIEW OF APPLICABLE LAW

[The court may want to consider giving preliminary instructions on the patent law applicable to the specific issues in the case. This could help focus the jury on the facts relevant to the issues it will have to decide. If this is done, the instructions intended to be given after the close of evidence could be adapted and given as preliminary instructions. This, of course, would not negate the need to give complete instructions at the close of evidence.]

A.5. Preliminary Instructions

OUTLINE OF TRIAL

The trial will now begin. First, each side may make an opening statement. An opening statement is not evidence. It is simply an outline to help you understand what that party expects the evidence will show.

The presentation of evidence will then begin. Witnesses will take the witness stand and the documents will be offered and admitted into evidence. There are two standards of proof that you will apply to the evidence, depending on the issue you are deciding. On some issues, you must decide whether something is more likely true than not. On other issues you must use a higher standard and decide whether it is highly probable that something is true.

[Patent holder] will present its evidence on its contention that [some] [the] claims of the [] patent have been [and continue to be] infringed by [alleged infringer] [and that the infringement has been [and continues to be] willful.] These witnesses will be questioned by [Patent holder]’s counsel in what is called direct examination. After the direct examination of a witness is completed, the opposing side has an opportunity to cross-examine the witness. To prove infringement of any claim, [patent holder] must persuade you that it is more likely than not that [alleged infringer] has infringed that claim. [To persuade you that any infringement was willful, [patent holder] must prove that it is highly probable that the infringement was willful.]

After [Patent holder] has presented its witnesses, [alleged infringer] will call its witnesses, who will also be examined and cross-examined. [Alleged infringer] will present its evidence that the claims of the [] patent are invalid. To prove invalidity of any claim, [alleged infringer] must persuade you that it is highly probable that the claim is invalid. In addition to presenting its evidence of invalidity, [alleged infringer] will put on evidence responding to [patent holder]’s infringement [and willfulness] contention[s].

[Patent holder] will then return and will put on evidence responding to [alleged infringer]’s contention that the claims of the [] patent are invalid. [Patent holder] will also have the option to put on what is referred to as “rebuttal” evidence to any evidence offered by [alleged infringer] of non-infringement [or lack of willfulness].

Finally, [alleged infringer] will have the option to put on “rebuttal” evidence to any evidence offered by [patent holder] on the validity of [some] [the] claims of the [] patent.

Appendix E: Model Patent Jury Instructions

[During the presentation of the evidence, the attorneys will be allowed brief opportunities to explain what they believe the evidence has shown or what they believe upcoming evidence will show. Such comments are not evidence and are being allowed solely for the purpose of helping you understand the evidence.]

Because the evidence is introduced piecemeal, you need to keep an open mind as the evidence comes in and wait for all the evidence before you make any decisions. In other words, you should keep an open mind throughout the entire trial.

[The parties may present the testimony of a witness by reading from his or her deposition transcript or playing a videotape of the witness's deposition testimony. A deposition is the sworn testimony of a witness taken before trial and is entitled to the same consideration as if the witness had testified at trial.]

After the evidence has been presented, [the attorneys will make closing arguments and I will give you final instructions on the law that applies to the case] [I will give you final instructions on the law that applies to the case and the attorneys will make closing arguments]. Closing arguments are not evidence. After the [closing arguments and instructions] [instructions and closing arguments], you will then decide the case.

B.1. Summary of Contentions

SUMMARY OF CONTENTIONS

I will first give you a summary of each side's contentions in this case. I will then tell you what each side must prove to win on each of its contentions. As I previously told you, [patent holder] seeks money damages from [alleged infringer] for allegedly infringing the [] patent by [making,] [importing,] [using,] [selling] and [offering for sale] [products] [methods] that [patent holder] argues are covered by claims [] of the patent. These are the asserted claims of the [] patent. [Patent holder] also argues that [alleged infringer] has [actively induced infringement of these claims of the [] patent by others] [contributed to the infringement of these claims of the [] patent by others]. The [products] [methods] that are alleged to infringe are [list of accused products or methods].

[Alleged infringer] denies that it has infringed the asserted claims of the patent and argues that, in addition, claims [] are invalid. [Add other defenses if applicable.]

Your job is to decide whether the asserted claims of the [] patent have been infringed and whether any of the asserted claims of the [] patent are invalid. If you decide that any claim of the patent has been infringed and is not invalid, you will then need to decide any money damages to be awarded to [patent holder] to compensate it for the infringement. [You will also need to make a finding as to whether the infringement was willful. If you decide that any infringement was willful, that decision should not affect any damage award you make. I will take willfulness into account later.]

B.2. Claim Construction

2.1 INTERPRETATION OF CLAIMS

Before you decide whether [alleged infringer] has infringed the claim[s] of the patent or whether the claim[s] [is][are] invalid, you will need to understand the patent claims. As I mentioned, the patent claims are numbered sentences at the end of the patent that describes the boundaries of the patent’s protection. It is my job as judge to explain to you the meaning of any language in the claim[s] that needs interpretation.

I have interpreted the meaning of some of the language in the patent claims involved in this case. You must accept those interpretations as correct. My interpretation of the language should not be taken as an indication that I have a view regarding the issues of infringement and invalidity. The decisions regarding infringement and invalidity are yours to make.

[Court gives its claim interpretation. This instruction must be coordinated with instruction 3.5 “Means-Plus-Function Claims—Literal Infringement” if the claims at issue include means-plus- function limitations.]

Authorities

Markman v. Westview Instruments, Inc., 517 U.S. 370, 384–91 (1996); *Phillips v. AWH Corp.*, 415 F.3d 1303, 1324 (Fed. Cir. 2005); *Pitney Bowes, Inc. v. Hewlett-Packard Co.*, 182 F.3d 1298, 1304–13 (Fed. Cir. 1999); *Cybor Corp. v. FAS Techs.*, 138 F.3d 1448 (Fed. Cir. 1998) (en banc); *Markman v. Westview Instruments, Inc.*, 52 F.3d 967, 977 (Fed. Cir. 1995) (en banc).

B.3. Infringement

3.1 INFRINGEMENT – BURDEN OF PROOF

I will now instruct you on the rules you must follow in deciding whether [patent holder] has proven that [alleged infringer] has infringed one or more of the asserted claims of the [] patent. To prove infringement of any claim, [patent holder] must persuade you that it is more likely than not that [alleged infringer] has infringed that claim.

Authorities

Warner-Lambert Co. v. Teva Pharm. USA, Inc., 418 F.3d 1326, 1341 n.15 (Fed. Cir. 2005); *Seal- Flex, Inc. v. Athletic Track and Court Constr.*, 172 F.3d 836, 842 (Fed. Cir. 1999); *Morton Int'l, Inc. v. Cardinal Chem. Co.*, 5 F.3d 1464, 1468–69 (Fed. Cir. 1993).

B.3. Infringement

3.2 DIRECT INFRINGEMENT

A patent's claims define what is covered by the patent. A [product] [method] directly infringes a patent if it is covered by at least one claim of the patent.

Deciding whether a claim has been directly infringed is a two-step process. The first step is to decide the meaning of the patent claim. I have already made this decision, [and I will instruct you later as to the meaning of the asserted patent claims] [and I have already instructed you as to the meaning of the asserted patent claims]. The second step is to decide whether [alleged direct infringer] has [made,] [used,] [sold,] [offered for sale] or [imported] within the United States a [product] [method] covered by a claim of the [] patent.¹ If it has, it infringes. You, the jury, make this decision.

[With one exception,] you must consider each of the asserted claims of the patent individually, and decide whether [alleged direct infringer]'s [product] [method] infringes that claim. [The one exception to considering claims individually concerns dependent claims. A dependent claim includes all of the requirements of a particular independent claim, plus additional requirements of its own. As a result, if you find that an independent claim is not infringed, you must also find that its dependent claims are not infringed. On the other hand, if you find that an independent claim has been infringed, you must still separately decide whether the additional requirements of its dependent claims have also been infringed.]

[You have heard evidence about both [patent holder]'s commercial [[product] [method]] and [alleged infringer]'s accused [[product] [method]]. However, in deciding the issue of infringement you may not compare [alleged infringer]'s accused [[product] [method]] to [patent holder]'s commercial [[product] [method]]. Rather, you must compare the [alleged infringer]'s accused [[product] [method]] to the claims of the [] patent when making your decision regarding infringement.]²

Whether or not [alleged infringer] knew its [product][method] infringed or even knew of the patent does not matter in determining direct infringement.

1. Consistent with the policy of these instructions not to propose instructions on issues that arise only rarely, we have not proposed instructions on international infringement under sections 35 U.S.C. 271(f) and (g). If those issues arise, the reference in this instruction to infringement "within the United States" should be modified accordingly. See *Microsoft Corp. v. AT&T Corp.*, 550 U.S. 437 (2007); *Bayer AG v. Housey Pharms. Inc.*, 340 F.3d 1367 (Fed. Cir. 2003).

2. This instruction is appropriate in cases where the plaintiff sells a commercial product and contends that such product practices at least one of the asserted patent claims.

There are two ways in which a patent claim may be directly infringed. A claim may be “literally” infringed, or it may be infringed under the “doctrine of equivalents.” The following instructions will provide more detail on these two types of direct infringement. [You should note, however, that what are called “means-plus-function” requirements in a claim are subject to different rules for deciding direct infringement. These separate rules apply to claims []. I will describe these separate rules shortly.]

Authorities

35 U.S.C. § 271; *Warner-Jenkinson Co., Inc. v. Hilton Davis Chem. Co.*, 520 U.S. 17 (1997); *Cross Med. Prods., Inc. v. Medtronic Sofamor Danek, Inc.*, 424 F.3d 1293, 1310-11 (Fed. Cir. 2005); *DeMarini Sports, Inc. v. Worth, Inc.*, 239 F.3d 1314, 1330-34 (Fed. Cir. 2001); *Seal-Flex, Inc. v. Athletic Track and Court Constr.*, 172 F.3d 836, 842 (Fed. Cir. 1999); *Carroll Touch, Inc. v. Electro Mech. Sys., Inc.*, 15 F.3d 1573, 1576 (Fed. Cir. 1993).

B.3. Infringement

3.3 LITERAL INFRINGEMENT

To decide whether [alleged infringer]’s [product] [method] literally infringes a claim of the [] patent, you must compare that [product] [method] with the patent claim and determine whether every requirement of the claim is included in that [product] [method]. If so, [alleged infringer]’s [product] [method] literally infringes that claim. If, however, [alleged infringer]’s [product] [method] does not have every requirement in the patent claim, [alleged infringer]’s [product] [method] does not literally infringe that claim. You must decide literal infringement for each asserted claim separately.

[If the patent claim uses the term “comprising,” that patent claim is to be understood as an open claim. An open claim is infringed as long as every requirement in the claim is present in [alleged infringer]’s [product] [method]. The fact that [alleged infringer]’s [product] [method] also includes other [parts] [steps] will not avoid infringement, as long as it has every requirement in the patent claim.]

[If the patent claim uses the term “consisting of,” that patent claim is to be understood as a closed claim. To infringe a closed claim, [alleged infringer]’s [product] [method] must have every requirement in the claim and no other [parts] [steps].]

[If the patent claim uses the term “consisting essentially of,” that patent claim is to be understood as a partially closed claim. A partially closed claim is infringed as long as every requirement in the claim is present in [alleged infringer]’s [product] [method]. The fact that [alleged infringer]’s [product] [method] also includes other [parts] [steps] will not avoid infringement so long as those [parts] [steps] do not materially affect the basic and novel properties of the invention. If [accused infringer]’s [product] [method] includes other [parts] [steps] that do change those basic and novel properties, it does not infringe.³]

[If [alleged infringer]’s [product] [method] does not itself include every requirement in the patent claim, [alleged infringer] cannot be liable for infringement merely because other parties supplied the missing elements, unless [accused infringer] directed or controlled the acts by those parties.] [Alleged infringer] does not direct or control someone else’s action merely because [alleged infringer] entered into a business relationship with that person. Instead, [alleged infringer] must specifically instruct or cause that other person to perform each step in an in-

3. Generally, only one of the three preceding paragraphs will be appropriate, depending on the transition used in the claim; the others should be omitted. In cases in which more than one claim is at issue, and the claims use different transitions, more than one paragraph will be used.

fringing manner, so that every step is attributable to [alleged infringer] as controlling party.

[If one party controls and makes use of a system that contains all the requirements of the claim, that party may be an infringer even though the parts of the system do not all operate in the same place or at the same time.]⁴

Authorities

MicroStrategy Inc. v. Bus. Objects, S.A., 429 F.3d 1344, 1352-53 (Fed. Cir. 2005); *Netword, LLC v. Centraal Corp.*, 242 F.3d 1347, 1353 (Fed. Cir. 2001); *Cole v. Kimberly-Clark Corp.*, 102 F.3d 524, 532 (Fed. Cir. 1996); *Ecolab, Inc. v. FMC Corp.*, 535 F.3d 1369 (Fed. Cir. 2009); *Cross Med. Prods. v. Medtronic Sofamor Danek*, 424 F.3d 1293 (Fed. Cir. 2005); *BMC Res., Inc. v. Paymentech, L.P.*, 498 F.3d 1373 (Fed. Cir. 2007).

4. The final sentence of this instruction is appropriate in cases involving system claims, but not method claims. *Centillion Data Sys., LLC v. Qwest Comm'ns Int'l*, 631 F.3d 1279 (Fed. Cir. 2011).

B.3. Infringement

3.4 INFRINGEMENT UNDER THE DOCTRINE OF EQUIVALENTS

If you decide that [alleged infringer]’s [product] [method] does not literally infringe an asserted patent claim, you must then decide whether that [product] [method] infringes the asserted claim under what is called the “doctrine of equivalents.”

Under the doctrine of equivalents, the [product] [method] can infringe an asserted patent claim if it includes [parts] [steps] that are identical or equivalent to the requirements of the claim. If the [product] [method] is missing an identical or equivalent [part] [step] to even one requirement of the asserted patent claim, the [product] [method] cannot infringe the claim under the doctrine of equivalents. Thus, in making your decision under the doctrine of equivalents, you must look at each individual requirement of the asserted patent claim and decide whether the [product] [method] has either an identical or equivalent [part] [step] to that individual claim requirement.

A [part] [step] of a [product] [method] is equivalent to a requirement of an asserted claim if a person of ordinary skill in the field would think that the differences between the [part] [step] and the requirement were not substantial as of the time of the alleged infringement.

Changes in technique or improvements made possible by technology developed after the patent application is filed may still be equivalent for the purposes of the doctrine of equivalents if it still meets the other requirements of the doctrine of equivalents set forth in this instruction.

[One way to decide whether any difference between a requirement of an asserted claim and a [part] [step] of the [product] [method] is not substantial is to consider whether, as of the time of the alleged infringement, the [part] [step] of the [product] [method] performed substantially the same function, in substantially the same way, to achieve substantially the same result as the requirement in the patent claim.]

[In deciding whether any difference between a claim requirement and the [product] [method] is not substantial, you may consider whether, at the time of the alleged infringement, persons of ordinary skill in the field would have known of the interchangeability of the [part] [step] with the claimed requirement. The known interchangeability between the claim requirement and the [part] [step] of the [product] [method] is not necessary to find infringement under the doctrine of equivalents. However, known interchangeability may support a conclusion that the difference between the [part] [step] in the [product] [method] and the claim requirement is not substantial. The fact that a [part] [step] of the [product] [method]

performs the same function as the claim requirement is not, by itself, sufficient to show known interchangeability.]

[You may not use the doctrine of equivalents to find infringement if you find that [alleged infringer]'s [product] [method] is the same as what was in the prior art before the application for the [] patent or what would have been obvious to persons of ordinary skill in the field in light of what was in the prior art. A patent holder may not obtain, under the doctrine of equivalents, protection that it could not have lawfully obtained from the Patent and Trademark Office.]⁵

[You may not use the doctrine of equivalents to find infringement if you find that the subject matter alleged to be equivalent to a requirement of the patent claim was described in the [] patent but not covered by any of its claims. The subject matter described but not claimed must be specific enough that one of ordinary skill in the art would understand that it was present in the patent.]

Authorities

Festo Corp. v. Shoketsu Kinzoku Kogyo Kabushiki Co., 535 U.S. 722 (2002); *Warner-Jenkinson Co., Inc. v. Hilton Davis Chem. Co.*, 520 U.S. 17 (1997); *Graver Tank & Mfg. Co. v. Linde Air Prods. Co.*, 339 U.S. 605, 609 (1950); *Abraxis Bioscience, Inc. v. Mayne Pharma (USA) Inc.*, 467 F.3d 1370, 1379-82 (Fed. Cir. 2006); *Pfizer, Inc. v. Teva Pharms., USA, Inc.*, 429 F.3d 1364, 1378 (Fed. Cir. 2005); *Johnston & Johnston Assoc. v. R.E. Service Co.*, 285 F.3d 1046 (Fed. Cir. 2002) (en banc); *Multiform Desiccants, Inc. v. Medzam, Ltd.*, 133 F.3d 1473, 1480 (Fed. Cir. 1998); *Dolly, Inc. v. Spalding & Evenflo Cos.*, 16 F.3d 394, 397 (Fed. Cir. 1994).

B.3. Infringement

5. If this instruction is applicable in a given case, then the court should instruct the jury that if [alleged infringer] has offered evidence sufficient to show that the accused [product] [method] is in the prior art, the burden shifts to the [patent holder] to prove that what it attempts to cover under the doctrine of equivalents is not in the prior art or would not have been obvious from the prior art. See *Fiskares, Inc. v. Hunt Mfg. Co.*, 221 F.3d 1318, 1323 (Fed. Cir. 2000); *Ultra-Tex Surfaces, Inc. v. Hill Bros. Chem. Co.*, 204 F.3d 1360, 1364-66 (Fed. Cir. 2000); *Streamfeeder, LLC v. Sure-Feed Sys., Inc.*, 175 F.3d 974, 981-84 (Fed. Cir. 1999).

3.5 MEANS-PLUS-FUNCTION CLAIMS – LITERAL INFRINGEMENT⁶

I will now describe the separate rules that apply to “means-plus-function” requirements that are used in some claims. Claims [] in the [] patent contain “means-plus-function” requirements. A means-plus-function requirement only covers the specific [structure] disclosed in a patent specification for performing the claimed function and the equivalents of those specific [structure] that perform the claimed function. A means-plus-function requirement does not cover all possible structures that could be used to perform the claimed function.

As an example, the term “means for processing data” might be understood to encompass a variety of different ways of making a calculation, including not only a computer or calculator but a pencil and paper or even the human brain. But because the phrase is a means-plus-function requirement, we interpret that phrase not to cover every possible means for processing data, but instead to cover the actual means disclosed in the patent for processing data and other means that are equivalent to it.

For purposes of this trial, I have interpreted each means-plus-function requirement for you and identified the structure in the patent specification that corresponds to these means-plus-function requirements. Specifically, I have determined that:

[X. [] is the structure that perform[s] the [] function identified in the means- plus-function requirement of claim [].]

[X. [] is the structure that perform[s] the [] function identified in the means- plus-function requirement of claim [].]

In deciding if [patent holder] has proven that [alleged infringer]’s [product] includes structure covered by a means-plus-function requirement, you must first decide whether the [product] has any structure that performs the function I just described to you. If not, the claim containing that means-plus-function requirement is not infringed.

If you find that the [alleged infringer]’s [accused product] does have structure that performs the claimed function, you must then determine whether that structure is the same as or equivalent to the structure I have identified in the specification. If they are the same or equivalent, the means- plus-function requirement is satisfied by that structure of the [accused product]. If all the other requirements of the claim are satisfied, the [accused product] infringes the claim.

6. If a claim at issue is a method claim with a limitation written in “step-plus-function” format, this instruction should be modified accordingly, for example, substituting “acts” for “structure.”

In order to prove that [a structure] in the [accused product] is equivalent to the structure in the [] patent, the [patent holder] must show that a person of ordinary skill in the field would have considered that the differences between the structure described in the [] patent and the structure in the [accused product] are not substantial. The [patent holder] must also show that the structure was available on the date the [] patent was granted.⁷

Authorities

35 U.S.C. § 112(6); *Frank's Casing Crew & Rental Tools, Inc. v. Weatherford Int'l, Inc.*, 389

F.3d 1370, 1378 (Fed. Cir. 2004); *Odetics, Inc. v. Storage Tech. Corp.*, 185 F.3d 1259, 1266 (Fed. Cir. 1999); *Chiuminatta Concrete Concepts, Inc. v. Cardinal Indus., Inc.*, 145 F.3d 1303,

1307 (Fed. Cir. 1998); *Micro Chem., Inc. v. Great Plains Chem. Co., Inc.*, 103 F.3d 1538, 1547 (Fed. Cir. 1997); *Valmont Indus., Inc. v. Reinke Mfg. Co., Inc.*, 983 F.2d 1039, 1042 (Fed. Cir. 1993).

7. There is an important difference between what can be an equivalent under § 112(6) and what can be an equivalent under the doctrine of equivalents. An equivalent structure or act under § 112(6) cannot embrace technology developed after the issuance of the patent because the literal meaning of a claim is fixed upon its issuance. *Chiuminatta Concrete Concepts, Inc. v. Cardinal Indus., Inc.*, 145 F.3d 1303, 1310 (Fed. Cir. 1998); *Al-Site Corp. v. VSI Int'l, Inc.*, 174 F.3d 1308, 1320 (Fed. Cir. 1999). Although new matter cannot be added to a patent application after it has been filed, current Federal Circuit law nevertheless uses the patent issuance date, as opposed to the effective filing date, to distinguish what constitutes an “after arising equivalent.” An after arising equivalent infringes, if at all, under the doctrine of equivalents and could infringe under the doctrine of equivalents and could infringe under the doctrine of equivalents without infringing literally under § 112(6). Furthermore, under § 112(6) the accused device must perform the identical function as recited in the claim element while the doctrine of equivalents may be satisfied when the function performed by the accused device is only substantially the same. *Al-Site*, 174 F3d. at 1320-21

B.3. Infringement

3.6 MEANS-PLUS-FUNCTION CLAIMS – INFRINGEMENT UNDER THE DOCTRINE OF EQUIVALENTS

[No model instruction is provided since an instruction on this subject is necessarily case specific. However, a means-plus-function requirement can be met under the doctrine of equivalents if the function is not the same but is equivalent (*see, e.g., WMS Gaming Inc. v. Int'l Game Tech.*, 184 F.3d 1339, 1353 (Fed. Cir. 1999) or the corresponding structure in the accused product is later developed technology. *See Chiuminatta Concrete Concepts, Inc. v. Cardinal Indus., Inc.*, 145 F.3d 1303, 1310 (Fed. Cir. 1998); *Al-Site Corp. v. VSI Int'l, Inc.*, 174 F.3d 1308, 1320 (Fed. Cir. 1999).]

B.3. Infringement

3.7 LIMITATIONS ON THE DOCTRINE OF EQUIVALENTS

Because [patent holder] made certain claim changes or statements during the patent application process for the [] patent, the doctrine of equivalents analysis cannot be applied to the following requirements of the asserted claims:

[List requirements on a claim-by-claim basis]

Unless each of these requirements is literally present within the [alleged infringer]'s [product] [method], there can be no infringement of the claim.

Authorities

Honeywell Int'l Inc. v. Hamilton Sundstrand Corp., 370 F.3d 1131 (Fed. Cir. 2004) (en banc); *Festo Corp. v. Shoketsu Kinzoku Kogyo Kabushiki Co., Ltd.*, 344 F.3d (Fed. Cir. 2003) (en banc).

B.3. Infringement

3.8 CONTRIBUTORY INFRINGEMENT

[Patent holder] [also] argues that [alleged infringer] has contributed to infringement by another. Contributory infringement may arise when someone supplies something that is used to infringe one or more of the patent claims.

In order for there to be contributory infringement by [alleged infringer], someone other than [alleged infringer] must directly infringe a claim of the [] patent; if there is no direct infringement by anyone, there can be no contributory infringement.

If you find someone has directly infringed the [] patent, then contributory infringement exists if:

- (1) [Alleged infringer] supplied an important component of the infringing part of the [product] or [method];
- (2) The component is not a common component suitable for non-infringing use; and
- (3) [Alleged infringer] supplied the component with the knowledge of the [] patent and knowledge that the component was especially made or adapted for use in an infringing manner.

A “common component suitable for non-infringing use” is a component that has uses [other than as a component of the patented product][other than in the patented method], and those other uses are not occasional, farfetched, impractical, experimental, or hypothetical.

Authorities

35 U.S.C. § 271(c); *PharmaStem Therapeutics, Inc. v. ViaCell, Inc. et. al.*, 491 F.3d 1342, 1356-58 (Fed. Cir. 2007); *Aro Mfg. Co. v. Convertible Top Replacement Co.*, 377 U.S. 476 (1964); *DSU Med. Corp. v. JMS Co.*, 471 F.3d 1293, 1303 (Fed. Cir. 2006); *Mentor H/S, Inc. v. Med. Device All., Inc.*, 244 F.3d 1365 (Fed. Cir. 2001); *Hewlett-Packard Co. v. Bausch & Lomb, Inc.*, 909 F.2d 1464, 1469 (Fed. Cir. 1990); *Preemption Devices, Inc. v. Minn. Mining & Mfr. Co.*, 803 F.2d 1170, 1174 (Fed. Cir. 1986).

B.3. Infringement

3.9 INDUCING PATENT INFRINGEMENT

[Patent holder] argues that [alleged infringer] has actively induced another to infringe the [] patent. In order for the [alleged infringer] to induce infringement, [alleged infringer] must have induced another to directly infringe a claim of the [] patent; if there is no direct infringement by anyone, there can be no induced infringement. In order to be liable for inducement of infringement, [alleged infringer]⁸ must:

1. have intentionally taken action that actually induced direct infringement;
2. have been aware of the [] patent;
3. have known that the acts it was causing would infringe the patent; and
4. not have had a good faith belief the patent was invalid.

If the four requirements just stated are not met, [alleged infringer] cannot be liable for inducement unless it actually believed that it was highly probable its actions would encourage infringement of a patent it believed to be valid and that it deliberately chose to avoid learning the truth. To prove inducement, it is not enough that [accused infringer] was merely indifferent to the possibility that its actions might encourage infringement of a valid patent. Nor is it enough that [accused infringer] took a risk that was substantial and unjustified.

In deciding whether the [alleged infringer] induced infringement, you may consider whether [accused infringer] actually believed that the acts it encouraged did not infringe the patent[, and whether [accused infringer] had a good-faith belief that the patent would be held invalid][, and whether [alleged infringer] relied on advice given by its lawyers].

Authorities

35 U.S.C. § 271(b); *Global-Tech Appliances, Inc. et al. v. SEB S.A.*, 131 S.Ct. 2060, ____ (2011); *DSU Med. Corp. v. JMS Co.*, 471 F.3d 1293, 1304-06 (Fed. Cir. 2006) (en banc) (quoting *Metro-Goldwyn-Mayer Studios Inc. v. Grokster, Ltd.*, 545 U.S. 913, 936 (2005)); *Broadcom Corp. v. Qualcomm, Inc.*, 543 F.3d 683 (Fed. Cir. 2008); *Lime-light Networks, Inc. v. Akamai Techs.*, 134 S.Ct. 2111, 572 U.S. ____ (2014); *Commil USA v. Cisco Sys.*, 720 F.3d 1361 (Fed. Cir. 2013).

8. [Alleged Infringer] in this instance refers to the alleged inducer infringer, not the alleged direct infringer.

B.3. Infringement

3.10 WILLFUL INFRINGEMENT

In this case, [patent holder] argues that [alleged infringer] willfully infringed the [patent holder]'s patent.

To prove willful infringement, [patent holder] must first persuade you that the [alleged infringer] infringed a valid [and enforceable] claim of the [patent holder]'s patent. The requirements for proving such infringement were discussed in my prior instructions.

In addition, to prove willful infringement, the [patent holder] must persuade you that it is highly probable that [alleged infringer] acted with reckless disregard of the claims of the [patent holder]'s [patent].

To demonstrate such "reckless disregard," [patent holder] must persuade you that [alleged infringer] actually knew, or it was so obvious that [alleged infringer] should have known, that its actions constituted infringement of a valid [and enforceable] patent.

In deciding whether [alleged infringer] acted with reckless disregard for [patent holder]'s patent, you should consider all of the facts surrounding the alleged infringement including, but not limited to, the following factors.

Factors that may be considered as evidence that [alleged infringer] was not willful include:

- (1) Whether [alleged infringer] acted in a manner consistent with the standards of commerce for its industry; [and]
- (2) Although there is no obligation to obtain an opinion of counsel whether [alleged infringer] relied on a legal opinion that was well-supported and believable and that advised [alleged infringer] (1) that the [product] [method] did not infringe [patent holder]'s patent or (2) that the patent was invalid [or unenforceable].⁹

Factors that may be considered as evidence that [alleged infringer] was willful include:

9. This bracketed language should only be included if the alleged infringer relies on advice of counsel. There is no affirmative obligation to obtain opinion of counsel. *In re Seagate Tech., LLC*, 497 F.3d 1360 (Fed. Cir. 2007) (en banc).

- (1) Whether [alleged infringer] intentionally copied a product of [patent holder] covered by the patent.

Authorities

35 U.S.C. § 284; *In re Seagate Tech., LLC*, 497 F.3d 1360 (Fed. Cir. 2007); *Knorr-Bremse Systeme Fuer Nutzfahrzeuge GmbH v. Dana Corp.*, 383 F.3d 1337, 1345 (Fed. Cir. 2004) (en banc); *Crystal Semiconductor Corp. v. Tritech Microelectronics Int'l, Inc.*, 246 F.3d 1336, 1346 (Fed. Cir. 2001); *WMS Gaming Inc. v. Int'l Game Tech.*, 184 F.3d 1339, 1354 (Fed. Cir. 1999); *Read Corp. v. Portec, Inc.*, 970 F.2d 816 (Fed. Cir. 1992); *Gustafson, Inc. v. Intersystems Indus. Prods., Inc.*, 897 F.2d 508, 510 (Fed. Cir. 1990).

[Note to judges: the Federal Circuit has held that “the judge may when the defense is a question of fact or a mixed question of law and fact allow the jury to determine the underlying facts relevant to the defense in the first instance, for example, the questions of anticipation or obviousness. But, consistent with this court’s holding today, the ultimate legal question of whether a reasonable person would have considered there to be a high likelihood of infringement of a valid patent should always be decided as a matter of law by the judge.” *Bard Peripheral Vascular v. W.L. Gore & Assocs.*, 682 F.3d 1003 (Fed. Cir. 2012). So the jury’s finding on the subjective prong *does not mean* that infringement was willful; it is the obligation of the judge to independently evaluate the objective basis for the underlying defense.]

B.4.1 Validity

4.1 INVALIDITY – BURDEN OF PROOF

I will now instruct you on the rules you must follow in deciding whether [alleged infringer] has proven that claims [] of the [] patent are invalid. Before discussing the specific rules, I want to remind you about the standard of proof that applies to this defense. To prove invalidity of any patent claim, [alleged infringer] must persuade you that it is highly probable that the claim is invalid.

[During this case, the [alleged infringer] has submitted prior art that was not considered by the United States Patent and Trademark Office (PTO) during the prosecution of the [] patent. The [alleged infringer] contends that such prior art invalidates certain claims of the [] patent. In deciding the issue of invalidity, you may take into account the fact that the prior art was not considered by the PTO when it issued the [] patent. Prior art that differs from the prior art considered by the PTO may carry more weight than the prior art that was considered and may make the [alleged infringer's] burden of showing that it is highly probable that a patent claim is invalid easier to sustain.

Authorities

Microsoft Corp. v. i4i Ltd. P'ship, 131 S.Ct. 2238, 2242, 2251, ___ U.S. ___ (2011); *Buildex. Inc. v. Kason Indus., Inc.*, 849 F.2d 1461, 1463 (Fed. Cir. 1988); *Hybritech, Inc. v. Monoclonal Antibodies, Inc.*, 802 F.2d 1367, 1375 (Fed. Cir. 1986).

B.4.2 Validity—Adequacy of Patent Specification

4.2a WRITTEN DESCRIPTION REQUIREMENT

A patent claim is invalid if the patent does not contain an adequate written description of the claimed invention. The purpose of this written description requirement is to demonstrate that the inventor was in possession of the invention at the time the application for the patent was filed, even though the claims may have been changed or new claims added since that time. The written description requirement is satisfied if a person of ordinary skill in the field reading the original patent application at the time it was filed would have recognized that the patent application described the invention as claimed, even though the description may not use the exact words found in the claim. A requirement in a claim need not be specifically disclosed in the patent application as originally filed if a person of ordinary skill would understand that the missing requirement is necessarily implied in the patent application as originally filed.

Authorities

35 U.S.C. § 112(1) and (2); *In Re Skvorecz*, 580 F.3d 1262, 1269 (Fed. Cir. 2009); *Kao Corp. v. Unilever U.S., Inc.*, 441 F.3d 963, 968 (Fed. Cir. 2006); *Chiron Corp. v. Genentech, Inc.*, 363 F.3d 1247 (Fed. Cir. 2004); *Purdue Pharma L.P. v. Faulding, Inc.*, 230 F.3d 1320, 1323 (Fed. Cir. 2000); *Lampi Corp. v. Am. Power Prods., Inc.*, 228 F.3d 1365, 1377-78 (Fed. Cir. 2000); *Gentry Gallery, Inc. v. Berklene Corp.*, 134 F.3d 1473, 1478-80 (Fed. Cir. 1998); *In re Alton*, 76 F.3d 1168, 1172 (Fed. Cir. 1996); *Univ. of Rochester v. G.D. Searle & Co.*, 358 F.3d 916, 926-928 (Fed. Cir. 2004).

B.4.2 Validity—Adequacy of Patent Specification

4.2b ENABLEMENT

A patent claim is invalid if the patent at the time it was originally filed did not contain a description of the claimed invention that is sufficiently full and clear to enable a person of ordinary skill in the field at the time to make and use the full scope of the invention. This is known as the “enablement” requirement.

The patent may be enabling even though it does not expressly state some information if a person of ordinary skill in the field could make and use the invention without having to do excessive experimentation. In determining whether excessive experimentation is required, you may consider the following factors:

- the scope of the claimed invention;
- the amount of guidance presented in the patent;
- the amount of experimentation necessary;
- the time and cost of any necessary experimentation;
- how routine any necessary experimentation is in the field of [identify field]; whether the patent discloses specific working examples of the claimed invention; the nature and predictability of the field;
- and
- the level of ordinary skill in the field of [identity field].

The question of whether a patent is enabling is judged as of the date the original application for the patent was first filed.¹⁰

Authorities

35 U.S.C. § 112(1); *Sitrick v. Dreamworks, LLC*, 516 F.3d 993, 999 (Fed. Cir. 2008); *Auto. Techs. Int’l, Inc. v. BMW of N. Am., Inc.*, 501 F.3d 1274, 1285 (Fed. Cir. 2007); *AK Steel Corp. v. Sollac & Ugine*, 344 F.3d 1234, 1244 (Fed. Cir. 2003); *Union Pac. Res. Co. v. Chesapeake Energy Corp.*, 236 F.3d 684, 690–92 (Fed. Cir. 2001); *Ajinomoto Co. v. Archer-Daniels-Midland Co.*, 228 F.3d 1338, 1345–46 (Fed. Cir. 2000); *In re Wands*, 858 F.2d 731, 737 (Fed. Cir. 1988).

10. Where a claim is the result of a continuation-in-part application and the priority date is disputed, this language will need to be revised to reflect the concept of effective filing date.

B.4.2 Validity—Adequacy of Patent Specification

4.2c BEST MODE¹¹

A patent claim is invalid if the patent does not disclose what [the inventor] [any of the inventors] believed was the best way to carry out the claimed invention at the time the patent application was filed. This is known as the “best mode” requirement. It ensures that the public obtains a full disclosure of the best way to carry out the claimed invention known to [the inventor] [any of the inventors] at the time the [original] patent application was first filed. The disclosure of the best mode must be detailed enough to enable the persons of ordinary skill in the field of [identity] field to carry out that best mode without excessive experimentation.

The best mode requirement focuses on what [the inventor] [any of the inventors] believed at the time the [original] patent application was first filed. It does not matter whether the best mode contemplated by [the inventor] [any of the inventors] was, in fact, the best way to carry out the invention. The question is whether the patent includes what [the inventor] [any of the inventors] believed was the best mode at the time the [original] patent application was filed. If [the inventor did not believe] [none of the inventors believed] there was a best way to carry out the invention at the time that application was filed, there is no requirement that the patent describe a best mode. Although a patent specification must disclose the best mode, it may disclose other modes as well and need not state which of the modes disclosed is best. If [the inventor] [any of the inventors] believed there was a better way to carry out the invention and the patent does not disclose it, the patent is invalid.

Authorities

35 U.S.C. § 112(1); *Pfizer, Inc. v. Teva Pharms. USA, Inc.*, 518 F.3d 1353, 1364–64 (Fed. Cir. 2008); *Cardiac Pacemaker, Inc. v. St. Jude Medical, Inc.*, 381 F.3d 1371, 1378–79 (Fed. Cir. 2004); *Glaxo Inc. v. Novopharm Ltd.*, 52 F.3d 1043, 1049–52 (Fed. Cir. 1995); *Transco Prods. v. Performance Contracting*, 38 F.3d 551 (Fed. Cir. 1994); *Wahl Instruments v. Acvious*, 950 F.2d 1575 (Fed. Cir. 1991); *Chemcast Corp. v. Arco Indus. Corp.*, 913 F.2d 923, 926–28 (Fed. Cir. 1990); *Spectra-Physics Inc. v. Coherent, Inc.*, 827 F.2d 1524 (Fed. Cir. 1987).

11. Applies only to civil actions commenced prior to September 16, 2011, the enactment date of the AIA. For civil actions commenced on or after September 16, 2011, Section 15 of the AIA (amended 35 U.S.C. § 282) provides “that the failure to disclose the best mode shall not be a basis on which any claim of a patent may be ... held invalid.”

B.4.3 Validity—The Claims

4.3a1 ANTICIPATION¹²

A patent claim is invalid if the claimed invention is not new. For the claim to be invalid because it is not new, all of its requirements must have existed in a single device or method that predates the claimed invention, or must have been described in a single previous publication or patent that predates the claimed invention. In patent law, these previous devices, methods, publications or patents are called “prior art references.” If a patent claim is not new we say it is “anticipated” by a prior art reference.

The description in the written reference does not have to be in the same words as the claim, but all of the requirements of the claim must be there, either stated or necessarily implied, so that someone of ordinary skill in the field of [identify field] looking at that one reference would be able to make and use the claimed invention.

Here is a list of the ways that [alleged infringer] can show that a patent claim was not new [use those that apply to this case]:

[– if the claimed invention was already publicly known or publicly used by others in the United States before [insert date of conception unless at issue];]

[– if the claimed invention was already patented or described in a printed publication anywhere in the world before [insert date of conception unless at issue]. [A reference is a “printed publication” if it is accessible to those interested in the field, even if it is difficult to find.];]

[– if the claimed invention was already made by someone else in the United States before [insert date of conception unless in issue], if that other person had not abandoned the invention or kept it secret;]

[– if the claimed invention was already described in another issued U.S. patent or published U.S. patent application that was based on a patent application filed before [insert date of the patent holder’s application filing date] [or] [insert date of conception unless at issue];]

[– if [named inventor] did not invent the claimed invention but instead learned of the claimed invention from someone else;]

12. This Section 4.3a1 is inapplicable to any post-AIA claims, i.e., to any claimed invention having an effective filing date on or after March 16, 2013.

[– if the [patent holder] and [alleged infringer] dispute who is a first inventor, the person who first conceived of the claimed invention and first reduced it to practice is the first inventor. If one person conceived of the claimed invention first, but reduced to practice second, that person is the first inventor only if that person (a) began to reduce the claimed invention to practice before the other party conceived of it and (b) continued to work diligently to reduce it to practice. [A claimed invention is “reduced to practice” when it has been tested sufficiently to show that it will work for its intended purpose or when it is fully described in a patent application filed with the PTO].]

[Since it is in dispute, you must determine a date of conception for the [claimed invention] [and/or] [prior invention]. Conception is the mental part of an inventive act and is proven when the invention is shown in its complete form by drawings, disclosure to another or other forms of evidence presented at trial.]

Authorities

35 U.S.C. § 102(a), (c), (e), (f) and (g); *Flex-Rest, LLC v. Steelcase, Inc.*, 455 F.3d 1351, 1358–60 (Fed. Cir. 2006); *Invitrogen Corp. v. Biocrest Mfg., L.P.*, 424 F.3d 1374, 1379–82 (Fed. Cir. 2005); *Apotex U.S.A., Inc. v. Merck & Co.*, 254 F.3d 1031, 1035 (Fed. Cir. 2001); *Mycogen Plant Sci., Inc. v. Monsanto Co.*, 243 F.3d 1316, 1330 (Fed. Cir. 2001); *Ecolochem, Inc. v. S. Cal. Edison Co.*, 227 F.3d 1361, 1367–70 (Fed. Cir. 2000); *Singh v. Brake*, 222 F.3d 1362, 1366–70 (Fed. Cir. 2000); *Pannu v. Iolab Corp.*, 155 F.3d 1344, 1349 (Fed. Cir. 1998); *Gambro Lundia AB v. Baxter Healthcare Corp.*, 110 F.3d 1573, 1576–78 (Fed. Cir. 1997); *Lamb-Weston, Inc. v. McCain Foods, Ltd.*, 78 F.3d 540, 545 (Fed. Cir. 1996); *In re Bartfeld*, 925 F.2d 1450 (Fed. Cir. 1985); *Ralston Purina Co. v. Far-Mar-Co, Inc.*, 772 F.2d 1570, 1574 (Fed. Cir. 1985); *Am. Stock Exch., LLC v. Mopies*, 250 F. Supp. 2d 323 (S.D.N.Y. 2003); *In re Wyer*, 655 F.2d 221, 226 (C.C.P.A. 1981).

B.4.3 Validity—The Claims

4.3a2 STATUTORY BARS¹³

A patent claim is invalid if the patent application was not filed within the time required by law. This is called a “statutory bar.” For a patent claim to be invalid by a statutory bar, all of its requirements must have been present in one prior art reference dated more than one year before the patent application was filed. Here is a list of ways [alleged infringer] can show that the patent application was not timely filed: [choose those that apply]

[– if the claimed invention was already patented or described in a printed publication anywhere in the world before [insert date that is one year before effective filing date of patent application]. [A reference is a “printed publication” if it is accessible to those interested in the field, even if it is difficult to find.];]

[– if the claimed invention was already being openly used in the United States before [insert date that is one year before application filing date] and that use was not primarily an experimental use (a) controlled by the inventor, and (b) to test whether the invention worked for its intended purpose;]

[– if a device or method using the claimed invention was sold or offered for sale in the United States, and that claimed invention was ready for patenting, before [insert date that is one year before application filing date]. [The claimed invention is not being [sold] [or] [offered for sale] if the [patent holder] shows that the [sale] [or] [offer for sale] was primarily experimental.] [The claimed invention is ready for patenting if it was actually built, or if the inventor had prepared drawings or other descriptions of the claimed invention that were sufficiently detailed to enable a person of ordinary skill in the field to make and use the invention based on them.];]

[– if the [patent holder] had already obtained a patent on the claimed invention in a foreign country before filing the original U.S. application, and the foreign application was filed at least one year before the U.S. application.]

For a claim to be invalid because of a statutory bar, all of the claimed requirements must have been either (1) disclosed in a single prior art reference, (2) implicitly disclosed in a reference to one skilled in the field, or (3) must have been present in

13. This Section 4.3a2 is inapplicable to any post-AIA claims, i.e., to any claimed invention having an effective filing date on or after March 16, 2013.

the reference, whether or not that was understood at the time. The disclosure in a reference does not have to be in the same words as the claim, but all the requirements must be there, either described in enough detail or necessarily implied, to enable someone of ordinary skill in the field of [identify field] looking at the reference to make and use the claimed invention.

Authorities

35 U.S.C. § 102(b) and (d); *Pfaff v. Wells Elec. Inc.*, 525 U.S. 55 (1998); *Schering Corp. v. Geneva Pharms.*, 339 F.2d 1273 (Fed. Cir. 2003); *Helifix Ltd. v. Blok-Lok, Ltd.*, 208 F.3d 1339, 1346 (Fed. Cir. 2000); *Abbot Labs. v. Geneva Pharms., Inc.*, 182 F.3d 1315, 1318 (Fed. Cir. 1999); *Finnigan Corp. v. Int'l Trade Comm'n*, 180 F.3d 1354 (Fed. Cir. 1999); *J.A. LaPorte, Inc. v. Norfolk Dredging Co.*, 787 F.2d 1577, 1581 (Fed. Cir. 1986); *In re Hall*, 781 F.2d 897, 898–99 (Fed. Cir. 1986); *D.L. Auld Co. v. Chroma Graphics Corp.*, 714 F.2d 1144, 1150 (Fed. Cir. 1983).

B.4.3 Validity—The Claims

4.3b OBVIOUSNESS¹⁴ – (Alternative 1)

Not all innovations are patentable. A patent claim is invalid if the claimed invention would have been obvious to a person of ordinary skill in the field [at the time the application was filed][as of [insert date]]. The court, however, is charged with the responsibility of making the determination as to whether a patent claim was obvious based upon your determination of several factual questions.

First, you must decide the level of ordinary skill in the field that someone would have had [at the time the claimed invention was made] [as of the effective filing date of the claimed invention]¹⁶¹⁵. In deciding the level of ordinary skill, you should consider all the evidence introduced at trial, including:

- (1) the levels of education and experience of persons working in the field;
- (2) the types of problems encountered in the field; and
- (3) the sophistication of the technology.

[Patent holder] contends that the level of ordinary skill in the field was []. [Alleged infringer] contends that the level of ordinary skill in the field was [].

Second, you must decide the scope and content of the prior art. [Patent holder] and [alleged infringer] disagree as to whether [identify prior art reference(s)] should be included in the prior art you use to decide the validity of claims [] of the [] patent. In order to be considered as prior art to the [] patent, these references must be reasonably related to the claimed invention of that patent. A

14. This instruction provides the jury with an instruction on the underlying factual questions it must answer to enable the court to make the ultimate legal determination of the obviousness question. The court, not the jury, should make the legal conclusion on the obviousness question based on underlying factual determinations made by the jury. *KSR Int'l Co. v. Teleflex, Inc.*, 550 U.S. 398, 427 (2007) (“The ultimate judgment of obviousness is a legal determination.”); see *Dippin’ Dots, Inc. v. Mosey*, 476 F.3d 1337, 1343 (Fed. Cir. 2007). It is anticipated that these factual issues will be presented to the jury as specifically as possible. For example, if the only dispute between the parties is whether a particular reference is with the “scope and content” of the prior art, that is the only *Graham* factor that should be presented to the jury. As another example, if the only factual dispute between the parties on the “difference between the prior art and the claimed invention” is whether a prior art reference discloses a particular claim limitation, that is the only issue that should be presented to the jury on that *Graham* factor. The introductory comment to the sample verdict form discusses further the functions of the judge and jury in determining obviousness.

15. The “effective filing date of the claimed invention” option is applicable to any post-AIA claims, i.e., to any claimed invention having an effective filing date on or after March 16, 2013.

reference is reasonably related if it is in the same field as the claimed invention or is from another field to which a person of ordinary skill in the field would look to solve a known problem.

Third, you must decide what difference, if any, existed between the claimed invention and the prior art.

Finally, you must determine which, if any, of the following factors have been established by the evidence:

- [(1) commercial success of a product due to the merits of the claimed invention];
- [(2) a long felt need for the solution provided by the claimed invention];
- [(3) unsuccessful attempts by others to find the solution provided by the claimed invention];
- [(4) copying of the claimed invention by others];
- [(5) unexpected and superior results from the claimed invention];
- [(6) acceptance by others of the claimed invention as shown by praise from others in the field or from the licensing of the claimed invention];
- [(7) other evidence tending to show nonobviousness];
- [(8) independent invention of the claimed invention by others before or at about the same time as the named inventor thought of it]; and]
- [(9) other evidence tending to show obviousness].]

Authorities

35 U.S.C. § 103; *Graham v. John Deere Co.*, 383 U.S. 1 (1966); *KSR Int'l Co. v. Teleflex, Inc.*, 550 U.S. 398, 407 (2007); *Ruiz v. A.B. Chance Co.*, 234 F.3d 654 (Fed. Cir. 2000); *Arkie Lures, Inc. v. Gene Larew Tackle, Inc.*, 119 F.3d 953, 957 (Fed. Cir. 1997); *Specialty Composites v. Cabot Corp.*, 845 F.2d 981, 991 (Fed. Cir. 1988); *Windsurfing Int'l, Inc. v. AMF, Inc.*, 782 F.2d 995, 1000 (Fed. Cir. 1986); *Pentec, Inc. v. Graphic Controls Corp.*, 776 F.2d 309, 313 (Fed. Cir. 1985). *See Novo Nordisk A/S v. Becton Dickinson & Co.*, 304 F.3d 1216, 1219–20 (Fed. Cir. 2002); *Wang Labs. v. Toshiba Corp.*, 993 F.2d 858, 864 (Fed. Cir. 1993); *Daiichi Sankyo Co. v. Apotex, Inc.*, 501 F.3d 1254, 1256 (Fed. Cir. 2007); *Brown & Williamson Tobacco Corp. v. Philip Morris Inc.*, 229 F.3d 1120, 1125 (Fed. Cir. 2000); *SIBIA Neurosciences, Inc. v. Cadus Pharm. Corp.*, 225 F.3d 1349, 1355 (Fed. Cir. 2000); *Ryko Mfg. Co. v. Nu-Star, Inc.*, 950 F.2d 714, 718–19 (Fed. Cir. 1991).

4.3b OBVIOUSNESS¹⁶ – (Alternative 2)

Not all innovations are patentable. A patent claim is invalid if the claimed invention would have been obvious to a person of ordinary skill in the field [at the time the claimed invention was made] [as of the effective filing date of the claimed invention]¹⁷ [as of [insert date]]. This means that even if all of the requirements of the claim cannot be found in a single prior art reference that would anticipate the claim or constitute a statutory bar to that claim, a person of ordinary skill in the field of [identify field] who knew about all this prior art would have come up with the claimed invention.

The ultimate conclusion of whether a claim is obvious should be based upon your determination of several factual decisions.

First, you must decide the level of ordinary skill in the field that someone would have had [at the time the claimed invention was made] [as of the effective filing date of the claimed invention]. In deciding the level of ordinary skill, you should consider all the evidence introduced at trial, including:

- (1) the levels of education and experience of persons working in the field;
- (2) the types of problems encountered in the field; and
- (3) the sophistication of the technology.

[Patent holder] contends that the level of ordinary skill in the field was [].
[Alleged infringer] contends that the level of ordinary skill in the field was [].

Second, you must decide the scope and content of the prior art. [Patent holder] and [alleged infringer] disagree as to whether [identify prior art reference(s)] should be included in the prior art you use to decide the validity of claims [] of the [] patent. In order to be considered as prior art to the [] patent, these references must be reasonably related to the claimed invention of that patent. A ref-

16. This instruction provides the jury with an instruction on how to analyze the obviousness question and reach a conclusion on it in the event that the Court decides to allow the jury to render an advisory verdict on the ultimate question of obviousness. However, the court, not the jury, should make the legal conclusion on the obviousness question based on underlying factual determinations made by the jury. *KSR Int'l Co. v. Teleflex, Inc.*, 550 U.S. 398, 427(2007) (“The ultimate judgment of obviousness is a legal determination.”); see *Dippin’ Dots, Inc. v. Mosey*, 476 F.3d 1337, 1343 (Fed. Cir. 2007). The introductory comment to the sample verdict form discusses further the functions of the judge and jury in determining obviousness.

17. The “effective filing date of the claimed invention” option is applicable to any post-AIA claims, i.e., to any claimed invention having an effective filing date on or after March 16, 2013.

erence is reasonably related if it is in the same field as the claimed invention or is from another field to which a person of ordinary skill in the field would look to solve a known problem.

Third, you must decide what difference, if any, existed between the claimed invention and the prior art.

Finally, you should consider any of the following factors that you find have been shown by the evidence:

- [(1) commercial success of a product due to the merits of the claimed invention];
- [(2) a long felt need for the solution provided by the claimed invention];
- [(3) unsuccessful attempts by others to find the solution provided by the claimed invention];
- [(4) copying of the claimed invention by others];
- [(5) unexpected and superior results from the claimed invention];
- [(6) acceptance by others of the claimed invention as shown by praise from others in the field or from the licensing of the claimed invention];
- [(7) other evidence tending to show nonobviousness];
- [(8) independent invention of the claimed invention by others before or at about the same time as the named inventor thought of it] [; and]
- [(9) other evidence tending to show obviousness].]

[The presence of any of the [list factors 1–7 as appropriate] may be considered by you as an indication that the claimed invention would not have been obvious [at the time the claimed invention was made] [as of the effective filing date of the claimed invention], and the presence of the [list factors 8–9 as appropriate] may be considered by you as an indication that the claimed invention would have been obvious at such time. Although you should consider any evidence of these factors, the relevance and importance of any of them to your decision on whether the claimed invention would have been obvious is up to you.]

A patent claim composed of several elements is not proved obvious merely by demonstrating that each of its elements was independently known in the prior art. In evaluating whether such a claim would have been obvious, you may consider whether [the alleged infringer] has identified a reason that would have prompted a person of ordinary skill in the field to combine the elements or concepts from the prior art in the same way as in the claimed invention. There is no single way to define the line between true inventiveness on the one hand (which is patentable) and the application of common sense and ordinary skill to solve a problem on the other hand (which is not patentable). For example, market forces or other design in-

Appendix E: Model Patent Jury Instructions

centives may be what produced a change, rather than true inventiveness. You may consider whether the change was merely the predictable result of using prior art elements according to their known functions, or whether it was the result of true inventiveness. You may also consider whether there is some teaching or suggestion in the prior art to make the modification or combination of elements claimed in the patent. Also, you may consider whether the innovation applies a known technique that had been used to improve a similar device or method in a similar way. You may also consider whether the claimed invention would have been obvious to try, meaning that the claimed innovation was one of a relatively small number of possible approaches to the problem with a reasonable expectation of success by those skilled in the art. However, you must be careful not to determine obviousness using the benefit of hindsight; many true inventions might seem obvious after the fact. You should put yourself in the position of a person of ordinary skill in the field [at the time the claimed invention was made] [as of the effective filing date of the claimed invention] and you should not consider what is known today or what is learned from the teaching of the patent.

Authorities

35 U.S.C. § 103; *Graham v. John Deere Co.*, 383 U.S. 1 (1966); *KSR Int'l Co. v. Teleflex, Inc.*, 550 U.S. 398, 407 (2007); *Ruiz v. A.B. Chance Co.*, 234 F.3d 654 (Fed. Cir. 2000); *Arkie Lures, Inc. v. Gene Larew Tackle, Inc.*, 119 F.3d 953, 957 (Fed. Cir. 1997); *Specialty Composites v. Cabot Corp.*, 845 F.2d 981, 991 (Fed. Cir. 1988); *Wind-surfing Int'l, Inc. v. AMF, Inc.*, 782 F.2d 995, 1000 (Fed. Cir. 1986); *Pentec, Inc. v. Graphic Controls Corp.*, 776 F.2d 309, 313 (Fed. Cir. 1985). *See Novo Nordisk A/S v. Becton Dickinson & Co.*, 304 F.3d 1216, 1219–20 (Fed. Cir. 2002); *Wang Labs. v. Toshiba Corp.*, 993 F.2d 858, 864 (Fed. Cir. 1993); *Daiichi Sankyo Co. v. Apotex, Inc.*, 501 F.3d 1254, 1256 (Fed. Cir. 2007); *Brown & Williamson Tobacco Corp. v. Philip Morris Inc.*, 229 F.3d 1120, 1125 (Fed. Cir. 2000); *SIBIA Neurosciences, Inc. v. Cadus Pharm. Corp.*, 225 F.3d 1349, 1355 (Fed. Cir. 2000); *Ryko Mfg. Co. v. Nu-Star, Inc.*, 950 F.2d 714, 718–19 (Fed. Cir. 1991).

B.4.3 Validity—The Claims

4.3c INVENTORSHIP

[[Alleged infringer] can meet its burden of proving that a patent is invalid by showing that it fails to name all actual inventors and only the actual inventors. This is known as the “inventorship” requirement.]

or

[To obtain correction of the inventors listed on the patent, or to prove a claim for [type of state law claim that requires proof of patent law inventorship], [plaintiff] must show that it is highly probable that [s]he is an actual inventor of the patent.]¹⁸

To be an inventor, one must make a significant contribution to the conception of one or more claims of the patent.¹⁹ Persons may be inventors even though they do not physically work together or make the same type or amount of contribution, or contribute to the subject matter of each claim of the patent. However, merely helping with experimentation by carrying out the actual inventor’s instructions or explaining the actual inventor’s well-known concepts or the current state of the art does not make someone an inventor.

Authorities

35 U.S.C. § 102(f) and 35 U.S.C. § 256; *Pannu v. Iolab Corp.*, 155 F.3d 1344, 1349–50 (Fed. Cir. 1998); *Hess v. Advanced Cardiovascular Sys.*, 106 F.3d 976, 980 (Fed. Cir. 1997); *Burroughs Wellcome Co. v. Barr Lab.*, 40 F.3d 1223, 1227–28 (Fed. Cir.

18. The former paragraph is appropriate where the defendant in an infringement suit claims that the patent is invalid for failure to name the correct inventors. The latter paragraph is appropriate when a plaintiff brings state-law claims that depend on the plaintiff proving his or her status as an inventor. *Shum v. Intel Corp.*, 499 F.3d 1272 (Fed. Cir. 2007). Those claims must apply the federal patent law standard. *Univ. of Colo. Found. v. Am. Cyanamid*, 196 F.3d 1366 (Fed. Cir. 1999). Fraud and unjust enrichment claims are examples, if the basis of the claim is that the plaintiff in fact invented the subject matter of the patent. Correction of inventorship is not an issue for the jury, and may be ordered in one set of circumstances if the omission of an inventor is without deceptive intention, but not in another set of circumstances. *Stark v. Advanced Magnetics, Inc., et al.*, 119 F.3d 1551 (Fed. Cir. 1997).

19. Alleged infringer, in order to meet its burden of proof, must present corroborating evidence of a contemporaneous disclosure that would enable one skilled in the field to make the claimed invention. Corroborating evidence may take many forms and is evaluated under a rule of reason analysis. The court should tailor instructions to the specific facts of the case. See *Linear Tech. Corp. v. Impala Linear Corp.*, 379 F.3d 1311 (Fed. Cir. 2004); *Univ. of Colo. Found., Inc. v. Am. Cyanimid Co.*, 342 F.3d 1298 (Fed. Cir. 2003).

Appendix E: Model Patent Jury Instructions

1994); *Shatterproof Glass Corp. v. Libbey-Owens Ford Co.*, 758 F.2d 613, 624 (Fed. Cir. 1985).

B.5. Patent Damages

5.1 DAMAGES – BURDEN OF PROOF

I will instruct you about the measure of damages. By instructing you on damages, I am not suggesting which party should win on any issue. If you find that [alleged infringer] infringed any valid claim of the [] patent, you must then determine the amount of money damages to be awarded to [patent holder] to compensate it for the infringement.

The amount of those damages must be adequate to compensate [patent holder] for the infringement. A damages award should put the patent holder in approximately the financial position it would have been in had the infringement not occurred, but in no event may the damages award be less than a reasonable royalty. You should keep in mind that the damages you award are meant to compensate the patent holder and not to punish an infringer.

[Patent holder] has the burden to persuade you of the amount of its damages. You should award only those damages that [patent holder] more likely than not suffered. While [patent holder] is not required to prove its damages with mathematical precision, it must prove them with reasonable certainty. [Patent holder] is not entitled to damages that are remote or speculative.

Authorities

35 U.S.C. § 284; *Dow Chem. Co. v. Mee Indus., Inc.*, 341 F.3d 1370, 1381–82 (Fed. Cir. 2003); *Grain Processing Corp. v. Am. Maize-Prod. Co.*, 185 F.3d 1341, 1349 (Fed. Cir. 1999); *Maxwell v. J. Baker, Inc.*, 86 F.3d 1098, 1108–09 (Fed. Cir. 1996); *Rite-Hite Corp. v. Kelley Co.*, 56 F.3d 1538, 1544–45 (Fed. Cir. 1995) (en banc).

B.5. Patent Damages

5.2 LOST PROFITS – GENERALLY

In this case, [patent holder] seeks to recover lost profits for some of [alleged infringer]’s sales of [infringing product], and a reasonable royalty on the rest of [alleged infringer]’s sales.

To recover lost profits for infringing sales, [patent holder] must show that but for the infringement there is a reasonable probability that it would have made sales that [alleged infringer] made of the infringing product. [Patent holder] must show the share of [alleged infringer]’s sales that it would have made if the infringing product had not been on the market.

Authorities

Aro Mfg. Co. v. Convertible Top Co., 377 U.S. 476, 502–07 (1964); *Beauregard v. Mega Sys., LLC*, 350 F.3d 1327, 1345–46 (Fed. Cir. 2003); *Central Soya Co. v. George A. Hormel & Co.*, 723 F.2d 1573, 1579 (Fed. Cir. 1983); *Lam, Inc. v. Johns-Manville Corp.*, 718 F.2d 1056, 1065 (Fed. Cir. 1983); *Versata Software, Inc. v. SAP Am., Inc.*, 717 F.3d 1255, 1265 (Fed. Cir. 2013); *Presidio Components, Inc. v. Am. Tech. Ceramics Corp.*, 702 F.3d 1351, 1360 (Fed. Cir. 2012).

B.5. Patent Damages

5.3 LOST PROFITS – FACTORS TO CONSIDER

[Patent holder] is entitled to lost profits if it proves all of the following:

- (1) that there was a demand for the patented [product] [method] [product produced by the method];
- (2) that there were no acceptable non-infringing substitutes for the [product] [method] for which [patent holder] seeks lost profits, or, if there were, the number of sales made by [alleged infringer] that [patent holder] would have made despite the availability of any acceptable non-infringing substitutes. An acceptable non-infringing substitute may involve modifying the [alleged infringer's] product to avoid infringement by adding an available alternative or by removing the patented feature from the product altogether.

An alternative may be considered available as a potential substitute even if it was not actually on sale during the infringement period. Factors suggesting that the alternative was available include whether the material, experience, and know-how for the alleged substitute were readily available and potential customers would have believed that the alternative was an acceptable substitute. Factors suggesting that the alternative was not available include whether the material was of such high cost as to render the alternative unavailable, whether potential customers would have believed that the alternative was an acceptable substitute and whether [alleged infringer] had to design or invent around the patented technology to develop an alleged substitute;

- (3) that [patent holder] had the manufacturing and marketing capacity to make any infringing sales actually made by the infringer and for which [patent holder] seeks an award of lost profits; and
- (4) the amount of profit that [patent holder] would have made if [alleged infringer] had not infringed.

Authorities

Versata Software, Inc. v. SAP Am., Inc., 717 F.3d 1255, 1264 (Fed. Cir. 2013); *Presidio Components, Inc. v. Am. Tech. Ceramics Corp.*, 702 F.3d 1351, 1360–61 (Fed. Cir. 2012).

B.5. Patent Damages

5.3a LOST PROFITS – MARKET SHARE

One way [patent holder] may prove the number of sales it would have made if the infringement had not happened is to prove its share of the relevant market excluding infringing products. You may award [patent holder] a share of profits equal to that market share.

In deciding [patent holder]’s market share, you must decide which products are in [patent holder]’s market. Products are in the same market if they are sufficiently similar to compete against each other. Two products are sufficiently similar if one does not have a significantly higher price than or possess characteristics significantly different than the other.

Authorities

Micro Chem., Inc. v. Lextron, Inc., 318 F.3d 1119, 1124 (Fed. Cir. 2003); *Crystal Semiconductor Corp. v. Tritech Microelectronics Int’l, Inc.*, 246 F.3d 1336, 1354–55 (Fed. Cir. 2001); *State Indus., Inc. v. Mor-Flo Indus., Inc.*, 883 F.2d 1573, 1580 (Fed. Cir. 1989).

B.5. Patent Damages

5.4 LOST PROFITS – COLLATERAL SALES

In this case, [patent holder] is seeking profits from sales of [x], which it contends it would have sold along with [y]. These products are called collateral products.

To recover lost profits on sales of such collateral products [patent holder] must prove two things. First, that it is more likely than not that [patent holder] would have sold the collateral products but for the infringement. Second, a collateral product and the patented product together must be analogous to components of a single assembly or parts of a complete machine, or they must constitute a functional unit.

Authorities

Rite-Hite Corp. v. Kelley Co., 56 F.3d 1538, 1550 (Fed. Cir. 1995) (en banc); *State Indus., Inc. v. Mor-Flo Indus., Inc.*, 883 F.2d 1573, 1580 (Fed. Cir. 1989); *Panduit Corp. v. Stahl Bros. Fibre Works, Inc.*, 575 F.2d 1152, 1157–58 (6th Cir. 1978).

B.5. Patent Damages

5.5 LOST PROFITS – PRICE EROSION

[Patent holder] can recover additional damages if it can show to a reasonable probability that, if there had been no infringement, [patent holder] would have been able to charge higher prices for some of its products. In that case, you may also award as additional damages the amount represented by the difference between the amount of profits that [patent holder] would have made by selling its product at the higher price and the amount of profits [patent holder] actually made by selling its product at the lower price that [patent holder] charged for its product. This type of damage is referred to as price erosion damage.

If you find that [patent holder] suffered price erosion, you may also use the higher price in determining [patent holder]'s lost profits from sales lost because of the infringement. In calculating a patentee's total losses from price erosion, you must take into account any drop in sales that would have resulted from a higher price.

You may also award as damages the amount of any increase in costs of [patent holder], such as additional marketing costs, caused by competition from the infringing product.

Authorities

Ericsson, Inc. v. Harris Corp., 352 F.3d 1369, 1377–79 (Fed. Cir. 2003); *Vulcan Eng'g Co. v. FATA Aluminum, Inc.*, 278 F.3d 1366, 1377 (Fed. Cir. 2002); *Crystal Semiconductor Corp. v. Tritech Microelectronics Int'l, Inc.*, 246 F.3d 1336, 1357–58 (Fed. Cir. 2001); *Minco, Inc. v. Combustion Eng'g, Inc.*, 95 F.3d 1109, 1120 (Fed. Cir. 1996); *BIC Leisure Prods., Inc. v. Windsurfing Int'l, Inc.*, 1 F.3d 1214, 1220 (Fed. Cir. 1993); *Kalman v. Berlyn Corp.*, 914 F.2d 1473, 1485 (Fed. Cir. 1990); *Wechsler v. Macke Int. Trade, Inc.*, 486 F. 3d 1286, 1293–94 (Fed. Cir. 2007).

B.5. Patent Damages

5.6 REASONABLE ROYALTY – ENTITLEMENT

If [patent holder] has not proved its claim for lost profits, or has proved its claim for lost profits for only a portion of the infringing sales, then [patent holder] should be awarded a reasonable royalty for all infringing sales for which it has not been awarded lost profits damages.

Authorities

35 U.S.C. § 284; *Crystal Semiconductor Corp. v. Tritech Microelectronics Int'l, Inc.*, 246 F.3d 1336 (Fed. Cir. 2001); *Fromson v. Western Litho Plate & Supply Co.*, 853 F.2d 1568, 1574 (Fed. Cir. 1998) (overruled on other grounds); *Minco, Inc. v. Combustion Eng'g, Inc.*, 95 F.3d 1109, 1119–20 (Fed. Cir. 1996); *Mahurkar v. C.R. Bard, Inc.*, 79 F.3d 1572, 1579 (Fed. Cir. 1996); *Rite-Hite Corp. v. Kelley Co.*, 56 F.3d 1538, 1554 (Fed. Cir. 1995) (en banc).

B.5. Patent Damages

5.7 REASONABLE ROYALTY – DEFINITION

A royalty is a payment made to a patent holder in exchange for the right to make, use or sell the claimed invention. This right is called a “license.” A reasonable royalty is the payment for the license that would have resulted from a hypothetical negotiation between the patent holder and the infringer taking place at the time when the infringing activity first began. In considering the nature of this negotiation, you must assume that the patent holder and the infringer would have acted reasonably and would have entered into a license agreement. You must also assume that both parties believed the patent was valid and infringed. Your role is to determine what the result of that negotiation would have been. The test for damages is what royalty would have resulted from the hypothetical negotiation and not simply what either party would have preferred.

A royalty can be calculated in several different ways and it is for you to determine which way is the most appropriate based on the evidence you have heard. One way to calculate a royalty is to determine what is called an “ongoing royalty.” To calculate an ongoing royalty, you must first determine the “base,” that is, the product on which the infringer is to pay. You then need to multiply the revenue the defendant obtained from that base by the “rate” or percentage that you find would have resulted from the hypothetical negotiation. For example, if the patent covers a nail, and the nail sells for \$1, and the licensee sold 200 nails, the base revenue would be \$200. If the rate you find would have resulted from the hypothetical negotiation is 1%, then the royalty would be \$2, or the rate of 0.01 times the base revenue of \$200. By contrast, if you find the rate to be 5%, the royalty would be \$10, or the rate of 0.05 times the base revenue of \$200. These numbers are only examples, and are not intended to suggest the appropriate royalty rate.

Instead of a percentage royalty, you may decide that the appropriate royalty that would have resulted from a hypothetical negotiation is a fixed number of dollars per unit sold. If you do, the royalty would be that fixed number of dollars times the number of units sold.

If the patent covers only part of the product that the infringer sells, then the base would normally be only that feature or component. For example, if you find that for a \$100 car, the patented feature is the tires which sell for \$5, the base revenue would be \$5. However, in a circumstance in which the patented feature is the reason customers buy the whole product, the base revenue could be the value of the whole product. Even if the patented feature is not the reason for customer demand, the value of the whole product could be used if, for example, the value of the patented feature could not be separated out from the value of the whole product. In such a case, however, the rate resulting from the hypothetical negotiation would be a lower rate because it is being applied to the value of the whole product and the

patented feature is not the reason for the customer's purchase of the whole product.

Another way to calculate a royalty is to determine a one-time lump sum payment that the infringer would have paid at the time of the hypothetical negotiation for a license covering all sales of the licensed product both past and future. This differs from payment of an ongoing royalty because, with an ongoing royalty, the licensee pays based on the revenue of actual licensed products it sells. When a one-time lump sum is paid, the infringer pays a single price for a license covering both past and future infringing sales.

It is up to you, based on the evidence, to decide what type of royalty is appropriate in this case. Authorities

Golight, Inc., v. Wal-Mart Stores, Inc., 355 F.3d 1327, 1338 (Fed. Cir. 2004); *Maxwell v. Baker, Inc.*, 86 F.3d 1098, 1108–10 (Fed. Cir. 1996); *Mahurkar v. C.R. Bard, Inc.*, 79 F.3d 1572, 1579–81 (Fed. Cir. 1996); *Rite-Hite Corp. v. Kelley Co.*, 56 F.3d 1538, 1554 (Fed. Cir. 1995)(en banc); *Georgia-Pacific Corp. v. United States Plywood Corp.*, 318 F. Supp. 1116, 1120 (S.D.N.Y. 1970).

B.5. Patent Damages

5.8 DATE OF COMMENCEMENT – PRODUCTS²¹²⁰

Damages that [patent holder] may be awarded by you commence on the date that [alleged infringer] has both infringed and been notified of the [] patent: [use those that apply to this case]

[[Patent holder] and [alleged infringer] agree that date was [insert date];]

[Since [patent holder] sells a product that includes the claimed invention but has not marked that product with the patent number, you must determine the date that [alleged infringer] received actual written notice of the [] patent and the specific product alleged to infringe;]

[Since [patent holder] [marks the product] or [does not sell a product covered by the patent], then damages begin without the requirement for actual notice under the following circumstances:

If the [] patent was granted before the infringing activity began, damages should be calculated as of the date you determine that the infringement began; or

If the [] patent was granted after the infringing activity began as determined by you, damages should be calculated as of [date patent issued].]

Authorities

35 U.S.C. § 287; *Crystal Semiconductor Corp. v. Tritech Microelectronics Int'l, Inc.*, 246 F.3d 1336 (Fed. Cir. 2001); *Nike Inc. v. Wal-Mart Stores*, 138 F.3d 1437, 1443–44 (Fed. Cir. 1998); *Maxwell v. Baker, Inc.*, 86 F.3d 1098, 1111–12 (Fed. Cir. 1996); *Am. Med. Sys. v. Med. Eng'g Corp.*, 6 F.3d 1523, 1534 (Fed. Cir. 1993); *Devices for Med., Inc. v. Boehl*, 822 F.2d 1062, 1066 (Fed. Cir. 1987).

20. This instruction may be used when the claim is an apparatus or product claim and [alleged infringer] is a direct infringer. Different rules may apply if the claim is a method claim or [alleged infringer] is an inducer or contributory infringer

B.5. Patent Damages

5.9 CALCULATING DAMAGES IN CASES OF INDUCEMENT OR CONTRIBUTORY INFRINGEMENT

In order to recover damages for induced infringement, [patent holder] must either prove that the [accused product] necessarily infringes the [patent in suit] or prove acts of direct infringement by others that were induced by [accused infringer]. Because the amount of damages for induced infringement is limited by the number of instances of direct infringement, [patent holder] must further prove the number of direct acts of infringement of the [patent in suit], for example, by showing individual acts of direct infringement or by showing that a particular class of [products] [uses] directly infringes.

In order to recover damages for contributory infringement, [patent holder] must either prove that the [accused product] necessarily infringes the [patent in suit] or prove acts of direct infringement by others to which [accused infringer] made a substantial contribution. Because the amount of damages for contributory infringement is limited by the number of instances of direct infringement, [patent holder] must further prove the number of direct acts of infringement of the [patent in suit], for example, either by showing individual acts of direct infringement or by showing that a particular class of [products] [uses] directly infringes.

Authorities

Dynacore Holdings Corp. v. U.S. Philips Corp., 363 F.3d 1263 (Fed. Cir. 2004); *Cardiac Pacemakers, Inc. v. St. Jude Med., Inc.*, 576 F.3d 1348 (Fed. Cir. 2009).

C.1 Appendix

GLOSSARY

Some of the terms in this glossary will be defined in more detail in the instructions you are given. The definitions in the instructions must be followed and must control your deliberations.

[Add any technical terms from the art involved that may be used during trial and have agreed- upon definitions and delete any of the following terms which may not be applicable in a particular case.]

Abstract: A brief summary of the technical disclosure in a patent to enable the U.S. Patent and Trademark Office and the public to determine quickly the nature and gist of the technical disclosure in the patent.

Amendment: A patent applicant's change to one or more claims or to the specification either in response to an office action taken by a Patent Examiner or independently by the patent applicant during the patent application examination process.

Anticipation: A situation in which a claimed invention describes an earlier invention and, therefore, is not considered new and is not entitled to be patented.

Assignment: A transfer of patent rights to another called an "assignee" who upon transfer becomes the owner of the rights assigned.

Best Mode: The best way the inventor actually knew to make or use the invention at the time of the patent application. If the applicant had a best mode as of the time the application was first filed, it must be set forth in the patent specification.

Claim: Each claim of a patent is a concise, formal definition of an invention and appears at the end of the specification in a separately numbered paragraph. In concept, a patent claim marks the boundaries of the patent in the same way that a legal description in a deed specifies the boundaries of land, i.e. similar to a land owner who can prevent others from trespassing on the bounded property, the inventor can prevent others from using what is claimed. Claims may be independent or dependent. An independent claim stands alone. A dependent claim does not stand alone and refers to one or more other claims. A dependent claim incorporates whatever the other referenced claim or claims say.

Conception: The complete mental part of the inventive act which must be capable of proof, as by drawings, disclosure to another, etc.

Continuation Application: A patent application filed during the examination process of an earlier application which has the same disclosure as the original application and does not include anything which would constitute new matter if inserted in the original application.

Continuation-In-Part (C-I-P) Application: A patent application filed during the application process of an earlier application which repeats some or all of the earlier application and adds matter not disclosed in the earlier application to support the addition of new patent claims.

Drawings: The drawings are visual representations of the claimed invention contained in a patent application and issued patent, and usually include several figures illustrating various aspects of the claimed invention.

Elements: The required parts of a device or the required steps of a method. A device or method infringes a patent if it contains each and every requirement of a patent claim.

Embodiment: A product or method that contains the claimed invention.

Enablement: A description of the invention that is sufficient to enable persons skilled in the field of the invention to make and use the invention. The specification of the patent must contain such an enabling description.

Examination: Procedure before the U.S. Patent and Trademark Office whereby a Patent Examiner reviews the filed patent application to determine if the claimed invention is patentable.

Filing Date: Date a patent application, with all the required sections, has been submitted to the U.S. Patent and Trademark Office.

Infringement: Violation of a patent occurring when someone makes, uses or sells a patented invention, without permission of the patent holder, within the United States during the term of the patent. Infringement may be direct, by inducement, or contributory. Direct infringement is making, using or selling the patented invention without permission. Inducing infringement is intentionally causing another to directly infringe a patent. Contributory infringement is offering to sell or selling an item that is an important component of the invention, so that the buyer directly infringes the patent. To be a contributory infringer one must know that the part being offered or sold is designed specifically for infringing the patented invention and is not a common component suitable for non-infringing uses.

Appendix E: Model Patent Jury Instructions

Limitation: A required part of an invention set forth in a patent claim. A limitation is a requirement of the invention. The word “limitation” is often used interchangeably with the word “requirement.”

Nonobviousness: One of the requirements for securing a patent. To be valid, the subject matter of the invention must not have been obvious to a person of ordinary skill in the field of the invention at the time of the earlier of the filing date of the patent application or the date of invention.

Office Action: A written communication from the Patent Examiner to the patent applicant in the course of the application examination process.

Patent: A patent is an exclusive right granted by the U.S. Patent and Trademark Office to an inventor to prevent others from making, using, offering to sell, or selling an invention within the United States, or from importing it into the United States, during the term of the patent. When the patent expires, the right to make, use or sell the invention is dedicated to the public. The patent has three parts, which are a specification, drawings and claims. The patent is granted after examination by the U.S. Patent and Trademark Office of a patent application filed by the inventor which has these parts, and this examination is called the prosecution history.

Patent and Trademark Office (PTO): An administrative branch of the U.S. Department of Commerce that is charged with overseeing and implementing the federal laws of patents and trademarks. It is responsible for examining all patent applications and issuing all patents in the United States.

Prior Art: Previously known subject matter in the field of a claimed invention for which a patent is being sought. It includes issued patents, publications, and knowledge deemed to be publicly available such as trade skills, trade practices and the like.

Prosecution History: The prosecution history is the complete written record of the proceedings in the PTO from the initial application to the issued patent. The prosecution history includes the office actions taken by the PTO and the amendments to the patent application filed by the applicant during the examination process.

Reads On: A patent claim “reads on” a device or method when each required part (requirement) of the claim is found in the device or method.

Reduction to Practice: The invention is “reduced to practice” when it is sufficiently developed to show that it would work for its intended purpose.

Reexamination: A process in which a patent is reexamined by the PTO to determine whether one or more of the claims are patentable with respect to submitted prior art which may consist only of prior patents or printed publications. An “ex parte” reexamination is initiated by the patent holder or a third party, but does not include the further participation of any third party. An “inter partes” reexamination is initiated by a third party who continues to participate in the proceedings.

Requirement: A required part or step of an invention set forth in a patent claim. The word “requirement” is often used interchangeably with the word “limitation.”

Royalty: A royalty is a payment made to the owner of a patent by a non-owner in exchange for rights to make, use or sell the claimed invention.

Specification: The specification is a required part of a patent application and an issued patent. It is a written description of the invention and of the manner and process of making and using the claimed invention.

C.2. Appendix

COMMENTS REGARDING USE OF SAMPLE VERDICT FORM

The following sample verdict form is provided for guidance in preparing an appropriate special verdict form tailored for your specific case. The sample is for a hypothetical case in which the patent holder alleges direct and indirect infringement of a single claim of one patent and seeks a combination of lost profits and a reasonable royalty for the allegedly infringing sales. The alleged infringer raises a number of invalidity defenses. No issue is raised, however, as to the conception date of the claimed invention. The issue of willfulness has not been bifurcated.

The form requires the jury to make specific findings on the bases for the affirmative defenses of “anticipation” and “statutory bars.”

The form also requires the jury to make factual determinations underlying a conclusion of “obviousness” or “nonobviousness.” It is expected that these issues will be presented to the jury as specifically as possible. For example, if the only dispute between the parties is whether a particular reference is within the “scope and content” of the prior art, that is the only question on that *Graham* factor that should be presented to the jury. As another example, if the only factual dispute between the parties on the “differences between the prior art and the claimed invention” is whether a prior art reference discloses a particular claim limitation, that is the only issue that should be presented to the jury on that *Graham* factor.

This form also provides two alternative section 11’s on obviousness. One asks the jury to only answer the underlying factual questions. The other permits the jury to give an advisory verdict on the ultimate question of obviousness. It must be remembered, however, that the ultimate question of obviousness is a question of law for the court. *KSR Int’l Co. v. Teleflex, Inc.*, 550 U.S. 398, 427 (2007) (“The ultimate judgment of obviousness is a legal determination.”); see *Dippin’ Dots, Inc. v. Mosey*, 476 F.3d 1337, 1343 (Fed. Cir. 2007). Both alternatives are designed to focus the parties and the court on the factual disputes on the obviousness question. For example, the form requires that each party specify exactly what it contends constitutes the scope and content of the prior art. Although trial courts have often permitted the jury to reach the final conclusion of obviousness without specifying its underlying factual determinations, such an approach is not recommended. The verdict form should require the jury’s finding on each factual issue so that the trial judge may make the final determination on the obviousness question. As Judge Michel pointed out in his dissent in *McGinley v. Franklin Sports, Inc.*, 262 F.3d 1339 (Fed. Cir. 2001):

The issue presented in this appeal derives from the common, if unfortunate, practice of allowing the jury to render a general verdict on the ultimate legal conclusion of obviousness without re-

quiring express findings on the underlying factual issues through a special verdict or special interrogatories under Fed. R. Civ. P. 49. Nevertheless, since the inception of our court, we have recognized that a court may submit this legal question to a jury and that doing so by general verdict rather than by Rule 49 is not ordinarily an abuse of discretion. We have emphasized, however, that there is no question that the judge must remain the ultimate arbiter on the question of obviousness.

Id. at 1358 (internal citations and quotation marks omitted). The fact that the verdict form allows the jury to give an advisory conclusion on obviousness should not be construed as suggesting that the court defer to the jury's ultimate determination on obviousness. The law is clear that the ultimate question is a legal one for the court.

C.3. Appendix

SAMPLE VERDICT FORM

When answering the following questions and filling out this Verdict Form, please follow the directions provided throughout the form. Your answer to each question must be unanimous. Some of the questions contain legal terms that are defined and explained in detail in the Jury Instructions. Please refer to the Jury Instructions if you are unsure about the meaning or usage of any legal term that appears in the questions below.

We, the jury, unanimously agree to the answers to the following questions and return them under the instructions of this court as our verdict in this case.

FINDINGS ON INFRINGEMENT CLAIMS

(The questions regarding infringement should be answered regardless of your findings with respect to the validity or invalidity of the patent.)

A. Direct Infringement

1. Has Patent Holder proven that it is more likely than not that every requirement of claim 1 of its patent is included in Alleged Infringer's accused product?

Yes _____ No _____

If your answer to question 1 is "yes," go to question 3. If your answer to question 1 is "no," go to question 2.

B. Infringement Under the Doctrine of Equivalents

2. Has Patent Holder proven that it is more likely than not that the accused product includes parts that are identical or equivalent to every requirement of claim 1 of Patent Holder's patent? In other words, for any requirement that is not literally found in the Alleged Infringer's accused product, does the accused product have an equivalent part to that requirement?

Yes _____ No _____

C. Contributory Infringement

3. Has Patent Holder proven that it is more likely than not: (i) that Direct Infringer infringed claim 1 of Patent Holder's patent; (ii) that Alleged Infringer supplied an

important component of the infringing part of the product; (iii) that the component was not a common component suitable for non-infringing use; and (iv) that Alleged Infringer supplied the component with knowledge of the patent and knowledge that the component was especially made or adapted for use in an infringing manner?

Yes _____ No _____

D. Inducing Infringement

4. Has Patent Holder proven that it is more likely than not: (i) that Direct Infringer infringed claim 1 of Patent Holder's patent; (ii) that Alleged Infringer took action that actually induced that infringement by Direct Infringer; and (iii) that Alleged Infringer was aware of the patent and believed that its actions would encourage infringement of a valid patent, or alternatively that it was willfully blind as to whether its actions would encourage infringement of the patent?

Yes _____ No _____

E. Willful Infringement

5a. Has the Patent Holder proven that it is highly probable that from an objective point of view the defenses put forth by Alleged Infringer failed to raise any substantial question with regard to infringement, validity or enforceability of the patent claim?

Yes _____ No _____

[If the answer to question 5a is "yes," answer question 5b. If your answer to question 5a is "no," go to question 6.]

5b. Has the Patent Holder proven that it is highly probable that the Alleged Infringer actually knew, or it was so obvious that Alleged Infringer should have known, that its actions constituted infringement of a valid and enforceable patent?

FINDINGS ON INVALIDITY DEFENSES

(The questions regarding invalidity should be answered regardless of your findings with respect to infringement.)

A. Written Description Requirement

6. Has Alleged Infringer proven that it is highly probable that the specification of the Patent Holder’s patent does not contain an adequate written description of the claimed invention?

Yes _____ No _____

B. Enablement

7. Has Alleged Infringer proven that it is highly probable that the specification of the Patent Holder’s patent does not contain a description of the claimed invention that is sufficiently full and clear to enable persons of ordinary skill in the field to make and use the invention?

Yes _____ No _____

C. Best Mode

8. Has Alleged Infringer proven that it is highly probable that the patent does not disclose what the inventor believed was the best way to carry out the claimed invention at the time the patent application was filed?

Yes _____ No _____

D. Anticipation

9. Has Alleged Infringer proven that it is highly probable that claim 1 of Patent Holder’s patent was “anticipated,” or, in other words, not new?

Yes _____ No _____

[If the answer is “yes,” check any reason below that is applicable:

_____ The claimed invention was already publicly known or publicly used by others in the United States before the date of conception of the claimed invention.

_____ The claimed invention was already patented or described in a printed publication anywhere in the world before the date of conception.

_____ The claimed invention was already made by someone else in the United States before the date of conception and that other person had not abandoned the invention or kept it secret.

_____ The claimed invention was already described in another issued U.S. patent or published U.S. patent application that was based on a patent application filed before the date of conception.

_____ The named inventor did not invent the claimed invention but instead learned of the claimed invention from someone else.

_____ The named inventor was not the first inventor of the claimed invention.]

E. Statutory Bar

10. Has Alleged Infringer proven that it is highly probable that claim 1 of Patent Holder's patent was not filed within the time required by law?

Yes _____ No _____

If the answer is "yes," check any reason below that is applicable:

_____ The claimed invention was already patented or described in a printed publication anywhere in the world at least one year before the filing date of the patent application.

_____ The claimed invention was already being openly used in the United States at least one year before the filing date of the patent application and that use was not primarily an experimental use to test whether the invention worked for its intended purpose which was controlled by the inventor.

_____ A device or method using the claimed invention was sold or offered for sale in the United States and the claimed invention was ready for patenting at least one year before the filing date of the patent application and that offer or sale was not primarily for experimental purposes to test whether the invention worked for its intended purpose and which was controlled by the inventor.

_____ Patent Holder had already obtained a patent on the claimed invention in a foreign country before the original U.S. application, and the foreign application was filed at least one year before the U.S. application.

F. Obviousness

[Alternative 1 – Jury decides underlying factual issues only]

11. The ultimate legal conclusion on the obviousness question will be made by the court. However, in order for the court to do so, you must answer the following preliminary factual questions:

a. What was the level of ordinary skill in the field that someone would have had at the time the claimed invention was made? (check the applicable answer)

_____ set forth Alleged Infringer’s contention, e.g., an individual with at least 3 years of experience in both furniture design and manufacture]

_____ [set forth Patent Holder’s contention, e.g., anyone who has worked in the field of furniture design or manufacture for at least two years]

_____ [other, specify _____]

b. What was the scope and content of the prior art at the time of the claimed invention? (check the applicable answer)

_____ [set forth what the Alleged Infringer has offered as the invalidating prior art, e.g., ’123 patent on fixed sitting device with four legs, general knowledge in field of industrial design that a horizontal surface may be held parallel to the ground using three legs and common knowledge that a person can easily move an object weighing under 25 pounds]

_____ [set forth what the Patent Holder asserts was within the scope and content of the prior art, e.g., ’123 patent on fixed sitting device with four legs]

_____ [other, specify _____]

c. What difference, if any, existed between the claimed invention and the prior art at the time of the claimed invention?

_____ [set forth the Alleged Infringer’s contention as to the difference, e.g., no difference between scope of invention and what is known in prior art]

_____ [set forth the Patent Holder's contention as to the difference, e.g., only 3 legs on a sitting device and portability]

_____ [other, specify _____]

d. Which of the following factors has been established by the evidence with respect to the claimed invention: (check those that apply)[verdict form should list only those factors for which a *prima facie* showing has been made]:

_____ commercial success of a product due to the merits of the claimed invention

_____ a long felt need for the solution that is provided by the claimed invention

_____ unsuccessful attempts by others to find the solution that is provided by the claimed invention

_____ copying of the claimed invention by others

_____ unexpected and superior results from the claimed invention

_____ acceptance by others of the claimed invention as shown by praise from others in the field or from the licensing of the claimed invention

_____ independent invention of the claimed invention by others before or at about the same time as the named inventor thought of it

[_____ other factor(s) indicating obviousness or nonobviousness—describe the factor(s)_____]

[Alternative 2 - Jury decides underlying factual issues and renders advisory verdict on obviousness]

11. The ultimate conclusion that must be reached on the obviousness question is whether Alleged Infringer has proven that it is highly probable that the claimed invention would have been obvious to a person of ordinary skill in the field at the time the patent application was filed. In order to properly reach a conclusion the following preliminary questions must be answered:

Appendix E: Model Patent Jury Instructions

a. What was the level of ordinary skill in the field that someone would have had at the time the claimed invention was made? (check the applicable answer)

_____ [set forth Alleged Infringer's contention, e.g., an individual with at least 3 years of experience in both furniture design and manufacture]

_____ [set forth Patent Holder's contention, e.g., anyone who has worked in the field of furniture design or manufacture for at least two years]

_____ [other, specify _____]

b. Was [disputed reference] within the scope and content of the prior art at the time of the claimed invention? (check only if reference was within the scope and content of the prior art)

_____ [set forth the prior art reference [alleged infringer] has offered as prior art that the [patent holder] disputes as being in the scope and content of the prior art. If there is more than one reference in dispute, each disputed reference should be listed separately.]

c. What difference, if any, existed between the claimed invention and the prior art at the time of the claimed invention?

_____ [set forth the Alleged Infringer's contention as to the difference, e.g., no difference between scope of invention and what is known in prior art]

_____ [set forth the Patent Holder's contention as to the difference, e.g., only 3 legs on a sitting device and portability]

_____ [other, specify _____]

d. Which of the following factors has been established by the evidence with respect to the claimed invention: (check those that apply)[verdict form should list only those factors for which a *prima facie* showing has been made]

_____ commercial success of a product due to the merits of the claimed invention

- _____ a long felt need for the solution that is provided by the claimed invention
- _____ unsuccessful attempts by others to find the solution that is provided by the claimed invention
- _____ copying of the claimed invention by others
- _____ unexpected and superior results from the claimed invention
- _____ acceptance by others of the claimed invention as shown by praise from others in the field or from the licensing of the claimed invention
- _____ independent invention of the claimed invention by others before or at about the same time as the named inventor thought of it
- [_____ other factor(s) indicating obviousness or nonobviousness—describe the factor(s)_____]

After consideration of the answers to the preliminary questions above, do you find that the Alleged Infringer has proven that it is highly probable that the claim of Patent Holder's patent would have been obvious to a person of ordinary skill in the field at the time the patent application was filed?

Yes _____ No _____

G. Inventorship

12. Has Alleged Infringer proven that it is highly probable that Patent Holder's patent fails to meet the requirement to name all actual inventors and only the actual inventors?

Yes _____ No _____

FINDINGS ON DAMAGES (IF APPLICABLE)

If you answered question 1, 2, 3 or 4 "yes" and questions 6, 7, 8, 9, 10, 11 and 12 "no," proceed to answer the remaining questions. If you did not so answer, do not answer the remaining questions and proceed to check and sign the verdict form.

Appendix E: Model Patent Jury Instructions

13. What lost profits, if any, did Patent Holder show it more likely than not suffered as a result of sales that it would with reasonable probability have made but for Alleged Infringer's infringement?

\$ _____

14. For those infringing sales for which Patent Holder has not proved its entitlement to lost profits, what has it proved it is entitled to as a reasonable royalty:

- a) on-going royalty payment of (1) \$_____ [per unit sold] or _____ % of \$_____ in total sales; or
- b) one-time payment of \$_____ for the life of the patent.

You have now reached the end of the verdict form and should review it to ensure it accurately reflects your unanimous determinations. The Presiding Juror should then sign and date the verdict form in the spaces below and notify the Security Guard that you have reached a verdict. The Presiding Juror should retain possession of the verdict form and bring it when the jury is brought back into the courtroom.

DATED: _____, 20 By: _____
Presiding Juror

AIPLA's Model Patent Jury Instructions

© 2015, American Intellectual Property Law Association

Disclaimer

The Model Jury Instructions are provided as general assistance for the litigation of patent issues. While efforts have been and will be made to ensure that the Model Jury Instructions accurately reflect existing law, this work is not intended to replace the independent research necessary for formulating jury instructions that are best suited to particular facts and legal issues. AIPLA does not represent that the information contained in the Model Jury Instructions is accurate, complete, or current. The work could contain typographical errors or technical inaccuracies, and AIPLA reserves the right to add, change, or delete its contents or any part thereof without notice.

Table of Contents

I. Introduction	176
II. Preliminary Jury Instructions	178
A. The Nature of the Action and the Parties	178
i. United States Patents	178
ii. Patent Litigation	179
B. Contentions of the Parties	180
C. Trial Procedure	181
III. Glossary of Patent Terms	182
IV. Glossary of Technical Terms	183
V. Post-Trial Instructions	184
1. Summary of Patent Issues	184
2. Claim Construction	184
2.0 Claim Construction – Generally	184
2.1 Claim Construction for the Case	185
2.2 Construction of Means-Plus-Function Claims for the Case	185
3. Infringement	186
3.0 Infringement – Generally	186
3.1 Direct Infringement – Knowledge of the Patent and Intent to Infringe are Immaterial	187
3.2 Direct Infringement – Literal Infringement	187
3.2.1 Direct Infringement – Joint Infringement	188
3.3 Literal Infringement of Means-Plus-Function or Step-Plus Function Claims	189
3.4 Infringement of Dependent Claims	190
3.5 Infringement of Open Ended or “Comprising” Claims	191
3.6 Direct Infringement – Infringement Under the Doctrine of Equivalents	192
3.7 Limitations on the Doctrine of Equivalents – Prior Art	193
3.8 Limitations on the Doctrine of Equivalents – Prosecution History Estoppel	194
3.9 Limitations on the Doctrine of Equivalents – Subject Matter Dedicated to the Public	195
3.10 Actively Inducing Patent Infringement	196
3.11 Infringement by Supply of all or a Substantial Portion of the Components of a Patented Invention to Another Country (§ 271(f)(1))	197
3.12 Contributory Infringement	198
3.13 Infringement by Supply of Components Especially Made or Adapted for Use in the Patented Invention into Another Country (§ 271(f)(2))	199
3.14 Infringement by Import, Sale, Offer for Sale or Use of Product Made by Patented Process (§ 271(g))	200
4. Summary of Invalidity Defense	200
5. Prior Art	201
5.0 Prior Art Defined (For patent claims having a priority date before March 16, 2013)	201
5.0 Prior Art Defined (For patent claims having a priority date after March 16, 2013)	202

5.1	Prior Art Considered or Not Considered by the USPTO	203
5.2	Invalidity of Independent and Dependent Claims	204
5.3	Person of Ordinary Skill in the Art (For patent claims having a priority date before March 16, 2013)	204
5.3	Person of Ordinary Skill in the Art (For patent claims having a priority date on or after March 16, 2013)	205
6.	Anticipation	205
6.0	Anticipation	205
6.1	Prior Public Knowledge (Pre-AIA)	206
6.2	Prior Public Use (Pre-AIA):	207
6.3	On Sale Bar (Pre-AIA):	210
6.4	Experimental Use	211
6.5	Printed Publication (Pre-AIA):	212
6.7	Prior Patent (Pre-AIA):	216
6.8	Prior U.S. Application (Pre-AIA):	217
7.	Obviousness	219
7.0	Obviousness	219
7.1	The First Factor: Scope and Content of the Prior Art	220
7.2	The Second Factor: Differences Between the Claimed Invention and the Prior Art	220
7.3	The Third Factor: Level of Ordinary Skill	222
7.4	The Fourth Factor: Other Considerations	222
8.	Enablement	224
9.	Written Description Requirement	225
10.	Unenforceability (Inequitable Conduct)	227
10.0	Inequitable Conduct – Generally	228
10.1	Materiality (Non-disclosure cases only)	228
10.2	Materiality (Affirmative Egregious Misconduct cases only)	229
10.3	Intent to Deceive or Mislead	230
11.	Damages	231
11.0	Damages – Generally	231
11.1	Date Damages Begin	232
11.1.1	Alternate A – When the Date of the Notice of Infringement is Stipulated	232
11.1.2	Alternate B – When the Date of the Notice of Infringement is Disputed – Product Claims	232
11.1.3	Alternate C – When the Date Damages Begin is the Date the Lawsuit was Filed	233
11.2	Damages – Types of Damages That May be Recovered	233
11.3	Lost Profits – “But-For” Test	234
11.4	Lost Profits – Panduit Factors	234
11.5	Lost Profits – Panduit Factors – Demand	235
11.6	Lost Profits – Panduit Factors – Acceptable Non-Infringing Substitutes	235
11.7	Lost Profits – Market Share	236
11.8	Lost Profits – Panduit Factors – Capacity	237

Appendix E: Model Patent Jury Instructions

11.9 Lost Profits – Panduit Factors – Amount of Profit Incremental Income Approach	237
11.10 Price Erosion	238
11.11 Cost Escalation	238
11.12 Convoys Sales	239
11.13 Reasonable Royalty – Generally	239
11.14 Reasonable Royalty Definition – Using the “Hypothetical Negotiation” Method	240
11.15 Relevant Factors if Using the Hypothetical Negotiation Method	240
11.16 Reasonable Royalty – Attribution	242
11.17 Reasonable Royalty – Entire Market Value Rule	242
11.18 Reasonable Royalty – Multiple Patents	243
11.19 Reasonable Royalty – Timing	243
11.20 Reasonable Royalty – Availability of Non-Infringing Substitutes	243
11.21 Reasonable Royalty – Use of Comparable License Agreements	244
11.22 Doubts Resolved Against Infringer	244
11.23 Standards Essential Patents	244
12. Willful Infringement	245
12.0 Willful Infringement – Generally	245
12.1 Willful Infringement – Absence of Legal Opinion	247
VI. Acknowledgments	248

I. Introduction

The 2015 Version

In the Winter of 2013, the Patent Litigation Committee of the American Intellectual Property Law Association once again undertook the task of updating the AIPLA Model Patent Jury Instructions (“Instructions”) to take into account changes to the law since the previous version of the Instructions were published. The Instructions were originally created in 1997 and were updated previously in 2005, 2008, and 2012. A Subcommittee was formed to review recent case law and make any necessary changes to the Instructions to conform to the significant changes in patent law over the last several years. The Subcommittee also continued its effort to simplify the Instructions and to improve the formatting so that the electronic version of the Instructions is easier to navigate. The current revision includes case law through December 31, 2014.

One of the fundamental goals of the Instructions is to provide a model set of jury instructions that would not be biased in favor of either the patent owner or the accused infringer. These Model Instructions are not intended to address every conceivable issue that might arise in patent litigation. Instead, Instructions are provided on those issues that typically arise in patent litigation and that have clear precedential support. It is incumbent upon the litigants to tailor these instructions to the specific issues in their particular case and to simplify the tasks for the Court and the jury by not providing superfluous or confusing instructions. It is also intended that these Instructions will be used in conjunction with other instructions dealing with non-patent issues such as credibility and that the trial court will further the jury’s understanding of these Instructions by relating the legal principles in the Instructions to the particular factual contentions of the parties.

To further these goals and to enhance the litigants’ ability to customize the Instructions to a particular case, these revised Instructions continue the use of bracketed terminology for certain consistent terms. This enables the litigants to use the find-and-replace feature of a word processing program to insert case specific facts. Examples of the terms are:

[subject matter]
[the patentee]
[the Plaintiff]
[the Defendant]
[full patent number]
[abbreviated patent number]
[claims in dispute]
[allegedly infringing product]
[invention date]
[U.S. filing date]
[critical date]
[effective filing date]

Appendix E: Model Patent Jury Instructions

[anticipating patent]
[alleged analogous art]
[alleged prior publication]
[alleged device on sale]
[infringement notice date]
[lawsuit filing date]
[beginning infringement date]
[collateral products]
[the Plaintiff's product]

In addition to these “find-and-replace” terms, brackets were also used to indicate where various terminology could be used to customize these Instructions to a particular case. For example, to take into account the differences between product and method patents, there will be instructions that include “[product] [method]” and the like. Other examples include “[product] [system],” “[importing] [selling] [offering to sell] [using]” and “[method] [process].”

The Subcommittee substantially completed these revisions in the fourth quarter of 2014. The AIPLA Board of Directors approved these Instructions for publication in June 2015. These Instructions, however, do not take into account case law or statutory changes that occurred in 2015.

December 2014
Felicia J. Boyd
Chair, Model Patent Jury Instructions Subcommittee
Patent Litigation Committee
American Intellectual Property Law Association

II. Preliminary Jury Instructions

Members of the jury:

Now that you have been sworn, I have the following preliminary instructions for your guidance on the nature of the case and on your role as jurors.

A. The Nature of the Action and the Parties

This is a patent case. The patents involved in this case relate to [subject matter] technology. [BRIEFLY DESCRIBE TECHNOLOGY INVOLVED].

During the trial, the parties will offer testimony to familiarize you with this technology. For your convenience, the parties have also prepared a Glossary of some of the technical terms to which they may refer during the trial, which will be distributed to you.

[The Plaintiff] is the owner of a patent, which is identified by the Patent Office number: [full patent number] (which may be called “the [abbreviated patent number] patent”); [IDENTIFY ADDITIONAL PATENTS]. This patent may also be referred to as “[the Plaintiff]’s patent.” [The Defendant] is the other party here.

i. United States Patents

Patents are granted by the United States Patent and Trademark Office (sometimes called the “PTO” or “USPTO”). A patent gives the owner the right to exclude others from making, using, offering to sell, or selling [[the patented invention] [a product made by the patented process]] within the United States or importing it into the United States. During the trial, the parties may offer testimony to familiarize you with how one obtains a patent from the PTO, but I will give you a general background here.

To obtain a patent, an application for a patent must be filed with the PTO. The application includes a specification, which should have a written description of the invention, and telling how it works and how to make and use it so as to enable others skilled in the art to do so. [The specification should also describe what the inventor believed at the time of filing to be the best way of making his or her invention.]²¹ The specification concludes with one or more numbered sentences or paragraphs. These are called the “claims” of the patent. The purpose of the claims is to particularly point out what the applicant regards as the invention and to define the scope of the patent owner’s exclusive rights.

After an application for a patent is filed with the PTO, the application is reviewed by a trained PTO Patent Examiner. The Patent Examiner reviews (or examines) the patent application to determine whether the claims are patentable and whether the specification adequately describes the invention claimed. In examining a patent application, the patent examiner searches records available to the PTO for

21. The bracketed sentence should only be read if a defense of failure to comply with best mode is raised against an asserted patent having a pre-AIA priority date.

what is referred to as “prior art,” and he or she also reviews prior art submitted by the applicant.

When the parties are done presenting evidence, I will give you more specific instructions as to what constitutes prior art in this case. Generally, prior art is previously existing technical information and knowledge against which the Patent Examiners determine whether or not the claims in the application are patentable.²² The Patent Examiner considers, among other things, whether each claim defines an invention that is new, useful, and not obvious in view of this prior art.

Following the prior art search and examination of the application, the Patent Examiner advises the applicant in writing what the patent examiner has found and whether any claim is patentable (in other words, “allowed”). This writing from the Patent Examiner is called an “office action.” More often than not, the initial Office Action by the Patent Examiner rejects the claims. The Applicant then responds to the Office Action and sometimes changes the claims or submits new claims. This process may go back and forth between the Patent Examiner and the Applicant for several months or even years until the Patent Examiner is satisfied that the Application and claims are patentable. At that time, the PTO “issues” or “grants” a patent with the allowed claims.

The collection of papers generated by the patent examiner and the applicant during this time of corresponding back and forth is called the “prosecution history.” You may also hear the “prosecution history” referred to as the “file history” or the “file wrapper.”

In this case, it is ultimately for you to decide, based on my instructions to you, whether the accused infringer has shown that the patent claims are invalid.

ii. Patent Litigation

Someone is said to be infringing a claim of a patent when they, without permission from the patent owner, import, make, use, offer to sell, or sell [[the patented invention] [a product made by the patented process]], as defined by the claims, within the United States before the term of the patent expires. A patent owner who believes someone is infringing the exclusive rights of a patent may bring a lawsuit, like this one, to attempt to address the alleged infringing acts and to recover damages, which generally means money paid by the infringer to the patent owner to compensate for the harm caused by the infringement. The patent owner must prove infringement of the claims of the patent. The patent owner must also prove the amount of damages he or she is entitled to.

A patent is presumed to be valid. In other words, it is presumed to have been properly granted. But that presumption of validity can be overcome if clear and convincing evidence is presented that proves the patent is invalid. One example

22. If the litigation involves a patent governed by the AIA, prior art is art that was effectively filed or published before the filing of the application or patent.

of a way in which the presumption may be overcome is if the PTO has not considered, for whatever reason, invalidating prior art that is presented to you. Someone accused of infringing a patent may deny that they infringe and/or prove that the asserted claims of the patent are invalid. If the opposing party challenges the validity of the patent, you must decide based on the instructions I will give you, whether the challenger has overcome the presumption of validity with proof that the asserted claims of the patent are invalid. The party challenging validity must prove invalidity by clear and convincing evidence. I will discuss more of this topic later.

I will now briefly explain the parties' basic contentions in more detail.

B. Contentions of the Parties

[The Plaintiff] contends that [the Defendant] makes, uses, offers to sell, or sells a [[product] [method]] that infringes [claim(s) in dispute] of the [abbreviated patent number] patent. [The Plaintiff] must prove that [the Defendant] infringes the [abbreviated patent number] patent by a preponderance of the evidence. That means that [the Plaintiff] must show that it is more likely that [the Defendant]'s [allegedly infringing product] infringes than it does not infringe.

There are two ways in which a patent claim can be directly infringed.²³ First, a claim can be literally infringed. Second, a claim can be infringed under what is called the "doctrine of equivalents." To determine infringement, you must compare the accused [[product] [method]] with each claim from the [abbreviated patent number] that [the Plaintiff] asserts is infringed. It will be my job to tell you what the language of the patent claims mean. You must follow my instructions as to the meaning of the patent claims. You are not to define the patent claims yourselves.

A patent claim is literally infringed only if [the Defendant]'s [[product] [method]] includes each and every [[element] [method step]] in that patent claim. If [the Defendant]'s [[product] [method]] does not contain one or more [[elements] [method steps]] in that claim, [the Defendant] does not literally infringe that claim. You must determine literal infringement with respect to each patent claim individually.

<p>Practice Note: To avoid jury confusion, it is important to distinguish those claims that are allegedly infringed literally from those that are allegedly infringed under the doctrine of equivalents. Rather than submit both to the jury, the Court should narrow the infringement contentions before the jury is charged in order to provide the jury clear guidance and avoid instructions that may be confusing.</p>
--

A patent claim is infringed under the doctrine of equivalents only if there is an equivalent [[component] [part] [method step]] in [the Defendant]'s [[product] [method]] for each [[element] [method step]] of the patent claim that is not literally

23. This section and below should be modified in accordance with the patent owner's infringement contentions, *e.g.*, where the doctrine of equivalents is not at issue.

present in [the Defendant]’s [[product] [method]]. In other words, [the Plaintiff] must prove that it is more likely than not that [the Defendant]’s [[product] [method]] contains the equivalent of each element of the claimed invention that is not literally present in the [allegedly infringing product]. An equivalent of an element is a [[component]] [[action]] that is insubstantially different from the claimed element. One way of showing that an element is insubstantially different is to show that it performs substantially the same function, in substantially the same way, to achieve substantially the same result as would be achieved by the element that is not literally present in the accused [[product]] [[method]].

[The Defendant] denies that it is infringing the [abbreviated patent number] patent and contends that the [abbreviated patent number] patent is invalid [and/or unenforceable].²⁴ [INSERT BRIEF DESCRIPTION OF THE PARTICULAR INVALIDITY AND UNENFORCEABILITY DEFENSES BEING ASSERTED].

Invalidity of the asserted patent claim(s) is a defense to infringement. Therefore, even though the PTO examiner has allowed the claims of the [abbreviated patent number] patent, you, the jury, must decide whether each claim of the [abbreviated patent number] patent that is challenged by [Defendant] is invalid. [The Defendant] must prove invalidity of each challenged claim by clear and convincing evidence in order to overcome the presumption of validity. Clear and convincing evidence means that it is highly probable that the fact is true. This standard is different than the standard that applies to other issues in this case. I have instructed you that other issues, such as infringement, may be found under a lower standard, namely, by a preponderance of the evidence. You may think of this “preponderance of the evidence” as slightly greater than 50%. This is different than the criminal law standard of “beyond a reasonable doubt.” You may think of this “beyond a reasonable doubt” standard as approaching certainty, without reasonable doubt. The “clear and convincing” standard is between the two.

C. Trial Procedure

We are about to commence the opening statements in the case. Before we do that, I want to explain the procedures that we will be following during the trial and the format of the trial. This trial, like all jury trials, comes in six phases. We have completed the first phase, which was to select you as jurors.

We are now about to begin the second phase, the Opening Statements. The opening statements of the lawyers are statements about what each side expects the evidence to show. The Opening Statements are not evidence for you to consider in your deliberations. You must make your decision based on the evidence and not the lawyers’ statements and arguments.

In the third phase, the evidence will be presented to you. Witnesses will take the witness stand and documents will be offered and admitted into evidence. [Plain-

24. This section and below should be modified in accordance with the Defendant’s defenses, e.g., where the Defendant has opted to not allege non-infringement or invalidity.

tiff] goes first in calling witnesses to the witness stand. These witnesses will be questioned by [the Plaintiff]’s counsel in what is called direct examination. After the direct examination of a witness is completed, the opposing side has an opportunity to cross-examine the witness. After [the Plaintiff] has presented its witnesses, [the Defendant] will call its witnesses, who will also be examined and cross-examined. The parties may present the testimony of a witness by having the individual testify live for you, by reading from their deposition transcript, or by playing a videotape of the witness’s deposition testimony. All three are acceptable forms of testimony. A deposition is the sworn testimony of a witness taken before trial and is entitled to the same consideration as if the witness had testified at trial.

The evidence often is introduced piecemeal, meaning that all of the evidence relating to an issue may not be presented all at one time but, rather, may be presented at different times during the trial. You need to keep an open mind as the evidence comes in. You are to wait until all the evidence comes in before you make any decisions. In other words, keep an open mind throughout the entire trial.

In the fourth phase, the lawyers will again have an opportunity to talk to you in what is called “Closing Argument.” As with the Opening Statements, what the lawyers say in the Closing Arguments is not evidence for you to consider in your deliberations.

In the fifth phase, I will read you the final jury instructions. I will instruct you on the law that you must apply in this case. I have already explained to you a little bit about the law. In the fifth phase, I will explain the law to you in more detail.

Finally, the sixth phase is the time for you to deliberate and reach a verdict. You will evaluate the evidence, discuss the evidence among yourselves, and make a decision in this case. We both have a job to do. You will decide the facts, and I will apply the law. I will explain the rules of law that apply to this case, and I will also explain the meaning of the patent claim language. You must follow my explanation of the law and the patent claim language, even if you do not agree with me. Nothing I say or do during the course of the trial is intended to indicate what your verdict should be on those facts that you must decide.

III. Glossary of Patent Terms

Application – The initial papers filed by the applicant in the United States Patent and Trademark Office (also called the Patent Office or PTO).

Claims – The numbered sentences or paragraphs appearing at the end of the patent that define the invention. The words of the claims define the scope of the patent owner’s exclusive rights during the life of the patent.

File wrapper – See “prosecution history” below.

License – Permission to use the patented invention(s), which may be granted by a patent owner (or a prior licensee) in exchange for a fee called a “royalty” or other compensation.

Office action – Communication from the patent examiner regarding the specification (see definition below) and/or the claims in the patent application.

Ordinary skill in the art – The level of experience, education, and/or training generally possessed by those individuals who work in the area of the invention at the time of the invention.

Patent Examiners – Personnel employed by the PTO in a specific technical area who review (examine) the patent application to determine (1) whether the claims of a patent application are patentable over the prior art considered by the examiner, and (2) whether the specification/application describes the invention with the required specificity.

Prior art (pre-AIA) – Knowledge that is available to the public either prior to the invention by the applicant or more than one year prior to the filing date of the application.

Prior Art (Post-AIA) – Knowledge that is publicly available before the effective filing date of the patent application.

Prosecution history – The written record of proceedings between the applicant and the PTO, including the original patent application and later communications between the PTO and applicant. The prosecution history may also be referred to as the “file history” or “file wrapper” of the patent during the course of this trial.

References – Any item of prior art used to determine patentability.

Specification – The information that appears in the patent and concludes with one or more claims. The specification includes the written text, the claims, and the drawings. In the specification, the inventor describes the invention, how it works, and how to make and use it.

[Others to be agreed upon between the parties]

IV. Glossary of Technical Terms

[To be agreed upon between the parties]

V. Post-Trial Instructions²⁵

1. Summary of Patent Issues

I will now summarize the issues that you must decide and for which I will provide instructions to guide your deliberations. You must decide the following [three] main issues:

1. Whether [the Plaintiff] has proved that [the Defendant] infringed Claim[s] [claims in dispute] of the [abbreviated patent number] patent.
2. Whether [the Defendant] has proved that Claim[s] [claims in dispute] of the [abbreviated patent number] patent are invalid.
3. What amount of damages, if any, [the Plaintiff] has proved.

[LIST ANY OTHER PATENT ISSUES]

2. Claim Construction

2.0 Claim Construction – Generally

Before you decide whether [the Defendant] has infringed the claims of [the Plaintiff]’s patent or whether [the Plaintiff]’s patent is invalid, you will have to understand the patent claims. The patent claims are numbered sentences at the end of the patent. The patent claims involved here are [claims in dispute], beginning at column ___, line ___ of the patent, which is exhibit ___ in evidence. The claims are intended to define, in words, the boundaries of the inventor’s rights. Only the claims of the patent can be infringed. Neither the written description, nor the drawings of a patent can be infringed. Each of the claims must be considered individually. You must use the same claim meaning for both your decision on infringement and your decision on invalidity.

35 U.S.C. § 112; *Source Search Techs., LLC v. LendingTree, LLC*, 588 F.3d 1063, 1075 (Fed. Cir. 2009); *Computer Docking Station Corp. v. Dell, Inc.*, 519 F.3d 1366, 1373 (Fed. Cir. 2008); *Phillips v. AWH Corp.*, 415 F.3d 1303 (Fed. Cir. 2005) (*en banc*); *Catalina Lighting, Inc. v. Lamps Plus, Inc.*, 295 F.3d 1277, 1286 (Fed. Cir. 2002); *Amazon.com, Inc. v. Barnesandnoble.com, Inc.*, 239 F.3d 1343, 1351 (Fed. Cir. 2001); *Markman v. Westview Instruments, Inc.*, 52 F.3d 967 (Fed. Cir. 1995) (*en banc*), *aff’d*, 517 U.S. 370 (1996); *SmithKline Diagnostics, Inc. v. Helena Labs. Corp.*, 859 F.2d 878, 882 (Fed. Cir. 1988).

25. AIPLA drafted these Model Jury Instructions assuming the litigated issues included in the instructions will be submitted to the jury. AIPLA is not suggesting that the parties have a right to a jury trial on all issues included in the instructions. The instructions used in your case should be tailored to the specific issues being litigated.

2.1 Claim Construction for the Case

It is my job as judge to provide to you the meaning of any claim language that must be interpreted. You must accept the meanings I give you and use them when you decide whether any claim has been infringed and whether any claim is invalid. I will now tell you the meanings of the following words and groups of words from the patent claims.

[READ STIPULATIONS AND COURT’S CLAIM CONSTRUCTIONS]

Phillips v. AWH Corp., 415 F.3d 1303 (Fed. Cir. 2005) (en banc); *Markman v. Westview Instruments, Inc.*, 52 F.3d 967 (Fed. Cir. 1995) (en banc) *aff’d*, 517 U.S. 370 (1996).

2.2 Construction of Means-Plus-Function Claims for the Case²⁶

The patentee may express an element for a claim in the form of a “means” or step for performing a function.

The asserted claims of the [abbreviated patent number] patent include the following clause: “_____”. I have determined, as a matter of law, that this is a means-plus-function element, as described in the section of the statute I read to you. This clause requires special interpretation. This element does not cover all [[means] [steps]] that perform the recited function of “_____”. Rather, I have determined that the recited function is “_____”. I have determined that [[structure] [step]] described in the patent specification and drawings that perform this recited function is “_____”, or an equivalent this [[structure] or [step]]. You must use this interpretation of the means-plus-function [[element] [step]] in your deliberations regarding infringement and validity, as further discussed below.

35 U.S.C. § 112; *Chicago Bd. Of Options Exchange, Inc. v. Int’l Secs. Exchange, LLC*, 677 F.3d 1361, 1366-69 (Fed. Cir. 2012); *Mettler-Toledo, Inc. v. B-Tek Scales, LLC*, 671 F.3d 1291, 1295-96 (Fed. Cir. 2012); *JVW Enters., Inc. v. Interact Accessories, Inc.*, 424 F.3d 1324, 1330-32 (Fed. Cir. 2005); *Utah Med. Prods., Inc. v. Graphic Controls Corp.*, 350 F.3d 1376, 1381 (Fed. Cir. 2003); *Carroll Touch, Inc.*

26. Give Instruction 2.2 only if the case involves means-plus-function claims. In Instruction 2.1, the court provides its construction of any terms for which a construction is needed. This should include its construction of any limitations governed by 35 U.S.C. § 112 ¶ 6, or § 112(f). Where the limitation uses the phrase “means for” or “step for,” a jury may nonetheless incorrectly conclude that the limitation includes any component or any step that accomplishes the specified function. To avoid confusing the jury, we recommend use of Instruction 2.2. Where the limitation is governed by 35 U.S.C. § 112 ¶ 6, or § 112(f), but does not use the phrase “means for” or “step for,” consideration should be given to whether Instruction 2.2 is unnecessary.

v. Electro Mech. Sys., Inc., 15 F.3d 1573, 1578 (Fed. Cir. 1993); *Valmont Indus., Inc. v. Reinke Mfg. Co., Inc.*, 983 F.2d 1039, 1042 (Fed. Cir. 1993).]

3. Infringement

3.0 Infringement – Generally

Questions _____ through _____ of the Verdict Form read as follows: [READ TEXT OF INFRINGEMENT VERDICT QUESTIONS].

I will now instruct you as to the rules you must follow when deciding whether [the Plaintiff] has proven that [the Defendant] infringed any of the claims of the [abbreviated patent number] patent.

Patent law gives the owner of a valid patent the right to exclude others from importing, making, using, offering to sell, or selling [[the patented invention] [a product made by a patented method]] within the United States during the term of the patent. Any person or business entity that has engaged in any of those acts without the patent owner's permission infringes the patent. Here, [the Plaintiff] alleges that [the Defendant]'s [allegedly infringing product] infringes claim[s] [claims in dispute] of [the Plaintiff]'s [abbreviated patent number] patent.

You have heard evidence about both [the Plaintiff]'s commercial [[product] [method]] and [the Defendant]'s accused [[product] [method]]. However, in deciding the issue of infringement you may not compare [the Defendant]'s accused [[product] [method]] to [the Plaintiff]'s commercial [[product] [method]]. Rather, you must compare the [Defendant]'s accused [[product] [method]] to the claims of the [abbreviated patent number] patent when making your decision regarding infringement.

Practice Note: To avoid jury confusion, it is important to distinguish those claims that are allegedly infringed directly from those that are allegedly infringed indirectly. In addition, it is important to distinguish those claims that are allegedly infringed literally from those allegedly infringed under the doctrine of equivalents. Finally, for indirect infringement, induced infringement should be distinguished from contributory infringement. In order to provide the jury with clear guidance and avoid confusion, the Court should only charge the jury on the specific infringement issues that are actually at issue. For example, if only literal infringement is asserted, there is no need to instruct the jury on the doctrine of equivalents.

A patent may be infringed directly or indirectly. As explained further in the following instructions, direct infringement results if the accused [[product] [method]] is covered by at least one claim of the patent. Indirect infringement results if the defendant induces another to infringe a patent or contributes to the infringement of a patent by another.

35 U.S.C. § 271; *Limelight Networks, Inc. v. Akamai Techs., Inc.*, 572 U.S. ___, 134 S. Ct. 2111, 189 L.Ed.2d 52 (2014); *Merial Ltd. v. CIPLA Ltd.*, 681 F.3d 1283, 1302-03 (Fed. Cir. 2012); *WiAV Solutions LLC v. Motorola, Inc.*, 631 F.3d 1257, 1264 (Fed. Cir. 2010); *WordTech Sys., Inc. v. Integrated Network Solutions, Inc.*, 609 F.3d 1308, 1313-18 (Fed. Cir. 2010).

3.1 Direct Infringement – Knowledge of the Patent and Intent to Infringe are Immaterial

In this case, [the Plaintiff] asserts that [the Defendant] has directly infringed the patent. [the Defendant] is liable for directly infringing [the Plaintiff]’s patent if you find that [the Plaintiff] has proven that it is more likely than not that [the Defendant] made, used, imported, offered to sell, or sold the invention defined in at least one claim of [the Plaintiff]’s patent.

Someone can directly infringe a patent without knowing of the patent or without knowing that what they are doing is an infringement of the patent. They also may directly infringe a patent even though they believe in good faith that what they are doing does not infringe a patent or if they believe in good faith that the patent is invalid.

35 U.S.C. § 271(a); *Medtronic, Inc. v. Mirowski Family Ventures, LLC*, 571 U.S. ___, 124 S. Ct. 843 (2014); *Global-Tech Appliances, Inc., v. SEB, S.A.*, 563 U.S. ___, n.2, 131 S. Ct. 2060, 2065 n.2 (2011); *Warner-Jenkinson Co. v. Hilton Davis Chem. Co.*, 520 U.S. 17, 35 (1997); *DeMarini Sports, Inc. v. Worth, Inc.*, 239 F.3d 1314, 1330 (Fed. Cir. 2001); *Seal-Flex, Inc. v. Athletic Track & Court Constr.*, 172 F.3d 836, 842 (Fed. Cir. 1999); *SmithKline Diagnostics, Inc. v. Helena Labs. Corp.*, 859 F.2d 878, 889 (Fed. Cir. 1988).

3.2 Direct Infringement – Literal Infringement

To determine literal infringement, you must compare the accused [[product] [method]] with each claim that [the Plaintiff] asserts is infringed, using my instructions as to the meaning of the patent claims.

A patent claim is literally infringed only if [the Defendant]’s [[product] [method]] includes each and every [[element] [method step]] in that patent claim. If [the Defendant]’s [[product] [method]] does not contain one or more [[elements] [method steps]] recited in a claim, [the Defendant] does not literally infringe that claim.

You must determine literal infringement with respect to each patent claim individually.

The accused [[product] [method]] should be compared to the invention described in each patent claim it is alleged to infringe. The same [[element] [method step]] of the accused [product] [method] may satisfy more than one element of a claim.

Intellectual Sci. & Tech. v. Sony Elect., 589 F.3d 1179, 1183 (Fed. Cir. 2009); *Hutchins v. Zoll Med. Corp.*, 492 F.3d 1377, 1380 (Fed. Cir. 2007); *BMC Resources v. Paymentech, L.P.*, 498 F.3d 1373, 1381-82 (Fed. Cir. 2007); *DeMarini Sports, Inc. v. Worth, Inc.*, 239 F.3d 1314, 1330-31 (Fed. Cir. 2001); *Gen. Mills, Inc. v. Hunt-Wesson, Inc.*, 103 F.3d 978, 981 (Fed. Cir. 1997); *Martin v. Barber*, 755 F.2d 1564, 1567 (Fed. Cir. 1985); *Amstar Corp. v. Envirotech Corp.*, 730 F.2d 1476, 1481-82 (Fed. Cir. 1984).

3.2.1 Direct Infringement – Joint Infringement²⁷

In this case, [the Defendant] is accused of direct infringement. [the Defendant] asserts that it has not directly infringed the [abbreviated patent number] patent because it did not perform each step of a claimed method or did not perform all the steps necessary to make, sell, offer for sale, or import [allegedly infringing product] because [another party] performed one of more of the acts necessary to infringe. If you find that one or more of the steps cannot be attributed to [the Defendant], then you must find that there is no joint infringement. For example, if you find that several parties have collectively committed the acts necessary to infringe but no single party has committed all of the required acts, then you must find that there is no joint infringement.

However, if you find that [the Defendant] performed all of the acts necessary to infringe, either personally or that the steps performed by the other person are attributable to [the Defendant], [the Defendant] directly infringes. In determining whether the steps are attributable to [the Defendant], you should consider whether [the Defendant] exercised direction or control over [the other party] when it performed these acts.

If you find that [the Defendant] and [the other party] have a contract that requires [the other party] to perform a step [[steps]] of the claimed method on [the Defendant]’s behalf, then you should find that [the Defendant] has granted [the other party] authority to act on [the Defendant]’s behalf and that [the other party] has agreed to so act.

Muniauction, Inc. v. Thomson Corp., 532 F.3d 1318 (Fed. Cir. 2008); *BMC Resources v. Paymentech, L.P.*, 498 F.3d 1373, 1381-82 (Fed. Cir. 2007). *Limelight Networks, Inc. v. Akami Techs., Inc.*, 572 U.S. ___, 134 S. Ct. 2111, 189 L.Ed.2d 52 (2014).

Practice Note: The concepts of direct infringement based on joint infringement and indirect infringement based on inducement to infringe (Instruction 3.10) are closely-related and may be confusing to the jury. Care should be taken to be clear regarding the instructions on each issue and what findings the jury is being

27. Give instructions on Joint Infringement and Active Inducement to Infringe only if these issues are raised and are adequately supported by the evidence.

asked to make. Only if these theories of infringement are alleged and have been adequately supported by sufficient evidence should these instructions be given. If both instructions are being given, consideration should be given to instructing on joint infringement and inducement to infringe (Instruction 3.10) back-to-back and in a manner that readily allows the jury to appreciate the difference between the two theories, the evidence required to support each, and the specific findings they are being asked to make on each.

3.3 Literal Infringement of Means-Plus-Function or Step-Plus-Function Claims²⁸

The Court has instructed you that claims _____ through _____ of the [abbreviated patent number] patent contain [[means-plus-function] [step-plus-function]] clauses. To establish infringement, [the Plaintiff] must prove that it is more likely than not that the [[part of the Defendant's product] [step in the Defendant's method]]: (1) performs the recited function of “_____”; and (2) is identical or equivalent to the [[structure] [step]] described in the patent specification and drawings for performing this recited function, namely, “_____”.

In deciding whether [the Plaintiff] has proven that [the Defendant]'s [[product] [method]] includes structure covered by a [[means-plus-function] [step-plus-function]] requirement, you must first decide whether the [[product] [method]] has any [[structure] [step]] that performs the specific function [step] that I just described to you. If not, the claim containing that means-plus-function [or step-plus-function] requirement is not infringed.

Even if you find that [the Defendant]'s [product] [method] includes some [structure] [step] that performs this specific function, you must next decide whether the [structure] [step] in [the Defendant]'s [[product] [method]] is the same as, or equivalent to, the structure recited in the specification for performing this specific function.

Whether the [[structure] [act]] of the accused product is equivalent to a [[structure] [act]] described in the patent specification is decided from the perspective of a person of ordinary skill in the art. If a person of ordinary skill in the art would consider the differences between the [[structure] [act]] found in [the Defendant]'s product and a [[structure] [act]] described in the patent specification to be insubstantial, the [[structures] [acts]] are equivalent. One way of showing that an element is insubstantially different is to show that it performs substantially the same

28. This Instruction should be given only if infringement of a means-plus-function claim is asserted and there is sufficient evidence to support this assertion.

function, in substantially the same way, to achieve substantially the same result as would be achieved by the element that is not literally present in the accused [[structure]][[act]].

Only if you find both that [the Defendant]’s [product] [method] has the same or equivalent [structure] [step] for performing the specific function can you find that the claim containing the [means-plus-function] or [step-plus-function] limitation is infringed. If you find that either the recited [structure] [step] is not performed or that the [structure] [step] in [the Defendant]’s product that performs this specific function is not the same or equivalent, you must find that the claim containing the means-plus-function limitation is not infringed.

35 U.S.C. § 112; *Cybor Corp. v. FAS Techs., Inc.*, 138 F.3d 1448, 1457 (Fed. Cir. 1998) (*en banc*); *In re Donaldson Co., Inc.*, 16 F.3d 1189, 1193 & 1195 (Fed. Cir. 1994) (*en banc*); *Chicago Bd. Options Exchange, Inc. v. Int’l. Secs. Exchange, LLC*, 677 F.3d 1361, 1366-69 (Fed. Cir. 2012); *Uniloc USA, Inc. v. Microsoft Corp.*, 632 F.3d 1292, 1304-05 (Fed. Cir. 2011); *General Protecht Gp., Inc. v. Int’l Trade Comm’n.*, 619 F.3d 1303, 1312-13 (Fed. Cir. 2010); *Baran v. Med. Device Tech., Inc.*, 616 F.3d 1309, 1316-17, (Fed. Cir. 2010); *Intellectual Sci. and Tech., Inc. v. Sony Elecs., Inc.*, 589 F.3d 1179, 1183 (Fed. Cir. 2009); *Applied Med. Resources Corp. v. U.S. Surgical Corp.*, 448 F.3d 1324, 1333-34 (Fed. Cir. 2006); *Chiuminatta Concrete Concepts, Inc. v. Cardinal Indus., Inc.*, 145 F.3d 1303, 1307-09 (Fed. Cir. 1998); *Kraft Foods Inc. v. Int’l Trade Comm.*, 203 F.3d 1362, 1371-73 (Fed. Cir. 2000).

3.4 Infringement of Dependent Claims

There are two different types of claims in the patent. One type is called an independent claim. The other is called a dependent claim.

An independent claim does not refer to any other claim of the patent. For example, [Independent Claim] is an independent claim. An independent claim must be read separately from the other claims to determine the scope of the claim.

A dependent claim refers to at least one other claim in the patent. For example, [Dependent Claim] is a dependent claim that refers to claim [Independent Claim]. A dependent claim includes all of the elements recited in the dependent claim, as well as all of the elements of [Independent Claim] the claim to which it refers.

To establish literal infringement of [Dependent Claim], [the Plaintiff] must show that it is more likely than not that the [Defendant]’s [[product] [method]] includes each and every element of [Independent Claim] and [Dependent Claim].

If you find that [Independent Claim] from which [Dependent Claim] depends is not literally infringed, then you must find that [Dependent Claim] is also not literally infringed.

Wolverine World Wide v. Nike Inc., 38 F.3d 1192, 1196-99 (Fed. Cir. 1994) (citing *Johnston v. IVAC Corp.*, 885 F.2d 1574, 1577-89 (Fed. Cir. 1989)); *Wilson Sporting Goods v. David Geoffrey & Assocs.*, 904 F.2d 677, 685-86 (Fed. Cir. 1990); *Wahpeton Canvas Co., Inc. v. Frontier, Inc.*, 870 F.2d 1546, 1552-53 nn.9&10 (Fed. Cir. 1989); *Shatterproof Glass Corp. v. Libbey-Owens Ford Co.*, 758 F.2d 613, 626 (Fed. Cir. 1985).

3.5 Infringement of Open Ended or “Comprising” Claims

(Alternative 1: “comprising”) The preamble to claim _____ uses the phrase [RECITE THE PREAMBLE “_____ comprising”]. The word “comprising” means “including the following but not excluding others.”

If you find that [the Defendant]’s [[product] [method]] includes all of the elements in claim _____, and that [the Defendant]’s [[product] [method]] it may include additional [[components] [method steps]], you must find that [the Defendant]’s [product] [method] literally infringes claim _____.

(Alternative 2: “consisting of”) The preamble to claim _____ uses the phrase [RECITE THE PREAMBLE “_____ consisting of”]. The word “consisting of” means “including the following and excluding others.”

If you find that [the Defendant]’s [[product] [method]] includes all of the elements in claim _____, and that [the Defendant]’s [[product] [method]] includes additional [[components] [method steps]], you must find that [the Defendant]’s product does not literally infringe claim _____.

(Alternative 3: “consisting essentially of”) The preamble to claim _____ uses the phrase [RECITE THE PREAMBLE “_____ consisting essentially of”]. The words “consisting essentially of” mean “including the following and possibly including unlisted [components][method steps] that do not materially affect the invention.”

CIAS Inc. v. Alliance Gaming Corp., 504 F.3d 1356 (Fed. Cir. 2007); *Norian Corp. v. Stryker Corp.*, 363 F.3d 1321, 1331(Fed. Cir. 2004); *Invitrogen Corp. v. Biocrest Mfg. LP*, 327 F.3d 1364, 1368 (Fed. Cir. 2003); *AFG Indus. v. Cardinal IG Co.*, 239 F.3d 1239, 1244-45 (Fed. Cir. 2001); *PPG Indus. v. Guardian Indus. Corp.*, 156 F.3d 1351, 1354 (Fed. Cir. 1998); *Moleculon Research Corp. v. CBS, Inc.*, 793 F.2d 1261, 1271 (Fed. Cir. 1986); *AB Dick Co. v. Burroughs Corp.*, 713 F.2d 700, 703 (Fed. Cir. 1983).

Practice Note: If the accused product or method includes all of the elements of the claim and also additional components or steps as well, the jury must find literal infringement as long as the additional elements do not negate any claim element. If the claim is literally infringed, there is no need to resort to the doctrine of equivalents. Similarly, the doctrine of equivalents is available only if one or more of the claim elements is not literally met. The patentee should be required to state their theory of infringement prior to trial and the jury should be charged on only the theory of infringement—literal and/or equivalents—that is adequately supported by the evidence.

3.6 Direct Infringement – Infringement Under the Doctrine of Equivalents²⁹

If you decide that [the Defendant]’s [[product] [method]] does not literally infringe an asserted patent claim, you must then decide whether it is more probable than not that [[product] [method]] infringes the asserted claim under what is called the “doctrine of equivalents.” Under the doctrine of equivalents, the [[product] [method]] can infringe an asserted patent claim if it includes [[parts] [steps]] that are equivalent to those elements of the claim that are not literally present in the [[product][method]]. If the [[product] [method]] is missing an equivalent [[part] [step]] to even one [[part] [step]] of the asserted patent claim, the [[product] [method]] cannot infringe the claim under the doctrine of equivalents. Thus, in making your decision under the doctrine of equivalents, you must look at each individual element of the asserted patent claim and decide whether the [[product] [method]] has an equivalent [[part] [step]] to the individual claim element(s) that are not literally present in the [[product][method]].

An equivalent of an element is a [[component]][[action]] that is insubstantially different from the claimed element. One way of showing that an element is insubstantially different is to show that it performs substantially the same function, in substantially the same way, to achieve substantially the same result as would be achieved by the element that is not literally present in the accused [[product]][[method]].

In deciding whether any difference between a claim requirement and the [[product] [method]] is not substantial, you may consider whether, at the time of the alleged infringement, persons of ordinary skill in the field would have known of the interchangeability of the [[part] [step]] with the claimed requirement. The known interchangeability between the claim requirement and the [[part] [step]] of the [[product] [method]] is not necessary to find infringement under the doctrine of equivalents.

29. This additional Instruction on equivalents should be given only if infringement under the doctrine of equivalents is properly before the court.

[Further, the same [[element] [method step]] of the accused [[product] [method]] may satisfy more than one element of a claim. If you find that all of the remaining elements of the claim are present in the accused [[product] [method]] and, further, that these differences are insubstantial, you may find infringement under the doctrine of equivalents.]³⁰

[Further, two [[elements] [methods]] of the accused [[product] [method]] may satisfy a single claimed. If you find that all of the remaining elements of the claim are present in the accused [[product] [method]] and, further, that these differences are insubstantial, you may find infringement under the doctrine of equivalents.]³¹

Warner-Jenkinson Co., Inc. v. Hilton Davis Chem. Co., 520 U.S. 17 (1997); *Graver Tank & Mfg. Co. v. Linde Air Prods. Co.*, 339 U.S. 605, 609 (1950); *Johnson & Johnston Assoc. v. R.E. Serv. Co.*, 285 F.3d 1046, 1053-54 (Fed. Cir. 2002) (*en banc*); *Multiform Desiccants, Inc. v. Medzam, Ltd.*, 133 F.3d 1473, 1480 (Fed. Cir. 1998); *Dolly, Inc. v. Spalding & Evenflo Cos.*, 16 F.3d 394, 397 (Fed. Cir. 1994); *Datascope Corp. v. SMEC, Inc.*, 776 F.2d 320, 325 (Fed. Cir. 1985); *Eagle Comtronics, Inc. v. Arrow Commc'n. Labs., Inc.*, 305 F.3d 1303, 1316-17 (Fed. Cir. 2002); *DeMarini Sports, Inc. v. Worth, Inc.*, 239 F.3d 1314, 1332, 57 USPQ2d 1889, 1900 (Fed. Cir. 2001) (citing *Dolly, Inc. v. Spalding & Evenflo Cos., Inc.*, 16 F.3d 394, 398, 29 USPQ2d 1767, 1769-70 (Fed. Cir. 1994)).

a. Limitations on the Doctrine of Equivalents – Prior Art³²

The patentee is not entitled to a scope of equivalents under the “doctrine of equivalents” that is so broad that the claim would cover [[products] [methods]] that were already in the prior art. In this case, [the Defendant] alleges that the scope of the claim under the doctrine of equivalents asserted by [the Plaintiff] would cover the prior art, namely, _____.

In order to show that [the Plaintiff] is not entitled to this scope of equivalents, [the Defendant] must prove to you that _____ was in the prior art.³³ [The Defendant] must show that it was in the prior art by a

30. *Eagle Comtronics, Inc. v. Arrow Commc'n. Labs., Inc.*, 305 F.3d 1303, 1316-17 (Fed. Cir. 2002); *DeMarini Sports, Inc. v. Worth, Inc.*, 239 F.3d 1314, 1332, 57 USPQ2d 1889, 1900 (Fed. Cir. 2001) (citing *Dolly, Inc. v. Spalding & Evenflo Cos., Inc.*, 16 F.3d 394, 398, 29 USPQ2d 1767, 1769-70 (Fed. Cir. 1994)).

31. *Id.*

32. This Instruction should be given only if the Defendant has identified sufficient evidence that this issue is genuinely disputed.

33. Although “ensnarement” is a question of law, a court may obtain an Advisory Verdict on this question necessitating inclusion of Instruction 3.7. In particular, the Federal Circuit has held that the question of whether the scope of a claim under the doctrine of equivalents ensnares the prior art is “ultimately . . . a question of law for the court, not the jury, to decide,” but “[i]f a district court believes that an advisory verdict would be helpful, and that a ‘hypothetical’ claim construct would not unduly confuse the jury as to equivalence and va-

preponderance of the evidence. This is different, and lower, namely, more likely than not, than the burden Defendant has to prove invalidity by clear and convincing evidence.

If you find that the claim including the alleged equivalent, namely, _____ was in the prior art, then you must find that [the Defendant] does not infringe the claim under the doctrine of equivalents. If you find that [the Defendant] has not proven to you that it is more likely than not that _____ is in the prior art, you may consider that [the Defendant] has not established this defense.

DePuy Spine, Inc. v. Medtronic Sofamor Danek, Inc., 567 F.3d 1314, 1322-24 (Fed. Cir. 2009); *Fiskars, Inc. v. Hunt Mfg. Co.*, 221 F.3d 1318, 1323 (Fed. Cir. 2000); *Conroy v. Reebok Int'l, Ltd.*, 14 F.3d 1570, 1576-77 (Fed. Cir. 1994); *Wilson Sporting Goods Co. v. David Geoffrey & Assocs.*, 904 F.2d 677, 683-85 (Fed. Cir. 1990).

Practice Note: The doctrine of prosecution history estoppel is determined by the Court. The following Instruction should be given only if the Court has determined that the doctrine of prosecution history estoppel applies as a matter of law. Specifically, this requires that the patentee made a representation or argument, or that an amendment to the claim was made for reasons related to patentability, and the presumption that the equivalent subject matter has been surrendered by the patentee has not been rebutted.

3.8 Limitations on the Doctrine of Equivalents – Prosecution History Estoppel³⁴

In this case, I have determined, as a matter of law, that the doctrine of equivalents cannot be applied to certain elements of the asserted claims. I am instructing you that the following elements cannot be considered equivalents to elements of the asserted claims:

[List Elements on a claim by claim basis]

Consequently, each of the elements above must be literally present within [the Defendant]’s [[product] [method]] for there to be infringement of the claim.

As for the remaining elements of the asserted claims not listed above, you are permitted to find these elements with the doctrine of equivalents analysis that I instructed you on earlier.

lidity, then one may be obtained under Federal Rule of Civil Procedure 39(c).” *DePuy Spine, Inc. v. Medtronic Sofamor Danek, Inc.*, 567 F.3d 1314, 1324 (Fed. Cir. 2009).

34. This Instruction should be given only if the Defendant has identified sufficient evidence that this issue is genuinely disputed.

Festo Corp. v. Shoketsu Kinzoku Kogyo Kabushiki Co., 535 U.S. 722 (2002); *Warner-Jenkinson Co. v. Hilton Davis Chem. Co.*, 520 U.S. 17, 30-34 (1997); *Festo Corp. v. Shoketsu Kinzoku Kogyo Kabushiki Co.*, 344 F.3d 1359, 1366-67 (Fed. Cir. 2003) (*en banc*).

3.9 Limitations on the Doctrine of Equivalents – Subject Matter Dedicated to the Public³⁵

When a patent discloses subject matter but does not include it within its claims, the patentee has dedicated the unclaimed subject matter to the public. If [the Patentee] alleges that a [[component] [step]] of [the Defendant]’s [product] [method] that [the patent] discloses but does not claim is equivalent to a limitation of the claim that is missing from [the Defendant]’s [product] [method] the [component] [step] cannot be an equivalent. Instead, the subject matter that was disclosed but not claimed is dedicated to the public. This is true even if the failure to claim the subject matter was wholly unintentional.

In this case, I have determined as a matter of law, that certain subject matter from the patent has been dedicated to the public and the doctrine of equivalents analysis cannot be applied to the following elements of the asserted claims:

[LIST ELEMENTS ON A CLAIM-BY-CLAIM BASIS]

Unless you find that each of the elements of the claims is literally present in [the Defendant]’s [[product] [method]], you must find that there is no infringement. *Pfizer, Inc. v. Teva Pharms., USA, Inc.*, 429 F.3d 1364, 1378-79 (Fed. Cir. 2005); *Toro Co. v. White Consol. Indus., Inc.*, 383 F.3d 1326 (Fed. Cir. 2004); *Johnson & Johnston Assocs. Inc. v. R.E. Serv. Co.*, 285 F.3d 1046, 1054-55 (Fed. Cir. 2002) (*en banc*).

Practice Note: The concepts of direct infringement based on joint infringement (Instruction 3.2) and indirect infringement based on inducement to infringe are closely-related and may be confusing to the jury. Care should be taken to be clear regarding the instructions on each issue and what findings the jury is being asked to make. Only if these theories of infringement are alleged and have been adequately supported by sufficient evidence should these instructions be given. If both instructions are being given, consideration should be given to instructing on joint infringement (Instruction 3.2) and inducement to infringe back-to-back and in a manner that readily allows the jury to appreciate the difference between the two theories, the evidence required to support each, and the specific findings they are being asked to make on each

35. This Instruction should be given only if the Defendant has identified sufficient evidence that this issue is genuinely disputed.

3.10 Actively Inducing Patent Infringement

In this case, [the Defendant] is accused of actively inducing [another entity] to directly infringe [the Plaintiff]’s patent, either literally or under the doctrine of equivalents. To find that [the Defendant] actively induced infringement, it is not necessary to show that [the Defendant] personally directly infringed, provided: (1) a single actor is responsible for direct infringement, namely, all of the [components] [steps] of the [product] [method] accused of infringing the patent; and (2) [the Defendant] actively induced these acts of infringement by [another entity]. If you do not find that there is direct infringement by a single actor, or if you do not find that [the Defendant] actively induced these acts, you must find that [the Defendant] did not induce infringement of the patent.³⁶

To prove active inducement, [the Plaintiff] must establish that it is more likely than not that:

1. [the Defendant] aided, instructed, or otherwise acted with the intent to cause acts by [alleged direct infringer] that would constitute direct infringement of the patent;
2. [the Defendant] knew of the patent, or showed willful blindness to the existence of the patent, at that time;
3. [the Defendant] knew, or showed willful blindness that it consciously ignored the possibility that its actions would infringe at least one claim of the patent; and
4. [alleged direct infringer] infringed at least one patent claim.

To find willful blindness: (1) [the Defendant] must have subjectively believed that there was a high probability that a patent existed covering [the accused product/process]; and (2) [the Defendant] must have taken deliberate actions to avoid learning of the patent.

35 U.S.C. § 271(b); *Limelight Networks, Inc. v. Akamai Techs., Inc.*, 572 U.S. ___, 134 S. Ct. 2111, 189 L.Ed.2d 52 (2014); *Global-Tech Appliances, Inc., v. SEB, S.A.*, 563 U.S. ___, 131 S. Ct. 2060 (2011); *Commil USA, LLC v. Cisco Sys., Inc.*, 720 F.3d 1361, 1368 (Fed. Cir. 2013); *DSU Medical Corp. v. JMS Co.*, 471 F.3d 1293, 1304-05 (Fed. Cir. 2006) (en banc) (quoting *Metro-Goldwyn-Mayer Studios, Inc. v. Grokster, Ltd.*, 545 U.S. 913, 936 (2005)); *Metabolite Labs., Inc. v. Lab. Corp. of Am. Holdings*, 370 F.3d 1354, 1365 (Fed. Cir. 2004); *Ferguson Beauregard/Logic Controls, Div. of Dover Res., Inc. v. Mega Sys., LLC*, 350 F.3d 1327, 1342 (Fed. Cir. 2003); *Manville Sales Corp. v. Paramount Sys., Inc.*, 917 F.2d 544, 553 (Fed. Cir.

36. The issue of active inducement to infringe is currently the subject of a petition for a writ of certiorari to the Federal Circuit, in *Commil v. Costco*, Docket No. 13-896,

1990); *Hewlett-Packard Co. v. Bausch & Lomb, Inc.*, 909 F.2d 1464, 1468-69 (Fed. Cir. 1990).

Bard Peripheral Vascular, Inc. v. W.L. Gore & Assocs., Inc., 682 F.3d 1003, 1006-08 (Fed. Cir. 2012); *Powell v. Home Depot USA, Inc.*, 663 F.3d 1221, 1236-37 (Fed. Cir. 2011); *i4i Ltd. P'Ship. v. Microsoft Corp.*, 598 F.3d 831, 859-60 (Fed. Cir. 2010); *Spine Solutions, Inc. v. Medtronic Sofamor Danek USA, Inc.*, 620 F.3d 1305, 1319 (Fed. Cir. 2010); *In re Seagate Tech., LLC*, 497 F.3d 1360 (Fed. Cir. 2007) (*en banc*); *Knorr-Bremse Systeme Fuer Nutzfahrzeuge GmbH v. Dana Corp.*, 383 F.3d 1337, 1347 (Fed. Cir. 2004) (*en banc*).

Practice Note: Each of the theories of indirect infringement has a number of elements and the Instructions tend to be complex. In order to avoid the risk of jury confusion, it is important to instruct the jury on only those issues that are properly before the Court. Consideration should be given to using case management techniques, such as charging the jury and having the jury deliberate on specific issues separately, to reduce the risk of confusion

3.11 Infringement by Supply of all or a Substantial Portion of the Components of a Patented Invention to Another Country (§ 271(f)(1))

[Plaintiff] asserts that [Defendant] infringed the [abbreviated patent number] patent by supplying [or causing to be supplied] all or a substantial portion of the components of the patented product from the United States to another country and actively inducing the assembly of those components into a product that would infringe the [abbreviated patent number] patent if they had been assembled in the United States.

To show infringement under Section 271(f)(1), [the Plaintiff] must prove that each of the following is more likely than not:

1. the product, as it was intended to be assembled outside the United States, [included][would have included] all limitations of at least one of claims ____ of the [abbreviated patent number] patent;
2. [the Defendant] supplied [or caused to be supplied] components from the United States that made up all or a substantial portion of the invention of any one of claims _____ of the [abbreviated patent number] patent; and
3. [the Defendant] specifically intended to induce the combination of the components into a product that would infringe the [abbreviated patent number] patent if the components had been combined in the United States.

35 U.S.C. § 271(f)(1); *Cardiac Pacemakers, Inc. v. St. Jude Medical, Inc.* 576 F.3d 1348, 1359-67 (Fed. Cir. 2009); *Microsoft Corp. v. AT&T Corp.*, 550 U.S. 437, 453-56 (2007); *Minn. Mining & Mfg. Co. v. Chemque, Inc.*, 303 F.3d 1294, 1304-05 (Fed. Cir. 2002).

3.12 Contributory Infringement

[The Plaintiff] asserts that [the Defendant] has contributed to infringement by another person.

To establish contributory infringement, [the Plaintiff] must prove that it is more likely than not that [the Defendant] had knowledge of both the patent and direct infringement of that patent. Plaintiff must prove that each of the following is more likely than not:

1. someone other than [the Defendant] has directly infringed the [abbreviated patent number] patent;
2. [the Defendant] sold, offered for sale, or imported within the United States a component of the infringing product or an apparatus for use in the infringing process;
3. the component or apparatus is not a staple article or commodity of commerce capable of substantial non-infringing use;
4. the component or apparatus constitutes a material part of the patented invention; and
5. [the Defendant] knew that the component was especially made or adapted for use in an infringing [[product] [method]].

Proof of [the Defendant's] knowledge may be shown with evidence of willful blindness where [the Defendant] consciously ignored the existence of both the patent and direct infringement of that patent. To find willful blindness: (1) [the Defendant] must have subjectively believed that there was a high probability that a patent existed covering [the accused product/process] and (2) [the Defendant] must have taken deliberate actions to avoid learning of the patent.

A “staple article or commodity of commerce capable of substantial non-infringing use” is something that has uses [[other than as a part or component of the patented product] [other than in the patented method]], and those other uses are not occasional, farfetched, impractical, experimental, or hypothetical.

To find contributory infringement, it is not necessary to show that [the Defendant] has directly infringed as long as you find that someone has directly infringed. If you find that there is no direct infringement by any one single entity, you must find that [the Defendant] did not contribute to the infringement of the patent.

35 U.S.C. § 271(c); *Global-Tech Appliances, Inc. v. SEB, S.A.*, 563 U.S. ___, 131 S. Ct. 2060, 2068-70 (2011); *Aro Mfg. Co. v. Convertible Top Replacement Co.*, 377 U.S. 476, 488 (1964); *Commil USA, LLC v. Cisco Sys., Inc.*, 720 F.3d 1361, 1368 (Fed. Cir. 2013); *Toshiba Corp. v. Imation Corp.*, 681 F.3d 1358, 1362 (Fed. Cir. 2012); *R+L Carriers, Inc. v. DriverTech LLC*, 681 F.3d 1323, 1337 (Fed. Cir. 2012); *Spanston, Inc. v. Int'l Trade Comm'n*, 629 F.3d 1331, 1353 (Fed. Cir. 2010); *Fujitsu Ltd. v. Netgear Inc.*, 620 F.3d 1321, 1326 (Fed. Cir. 2010).

3.13 Infringement by Supply of Components Especially Made or Adapted for Use in the Patented Invention into Another Country (§ 271(f)(2))

[The Plaintiff] asserts that [the Defendant] infringed the [abbreviated patent number] patent by supplying [or causing to be supplied] [a component][components] of an invention covered by at least one claim of the [abbreviated patent number] patent from the United States into a foreign country, where the exported component[s] [was][were] especially made or especially adapted for use in an invention covered by the [abbreviated patent number] patent and [has][have] no substantial non-infringing use[s], and where [the Defendant] knew the component[s] [was][were] especially made or adapted for use in the patented invention and intended for the component[s] to be combined in a way that would have infringed the [abbreviated patent number] patent if the combination had occurred in the United States.

To show infringement under Section 271(f)(2), [the Plaintiff] must prove that each of the following is more likely than not:

1. [the Defendant] actually supplied the components from the United States into a foreign country or caused them to be supplied from the United States to a foreign country;
2. [the Defendant] knew or should have known that the components were especially made or adapted for use in a product that infringes the [abbreviated patent number] patent;
3. those components have no substantial non-infringing use; and
4. [the Defendant] intended for the components to be combined into that product . It is not necessary for you to find that the components actually were combined into an infringing product, as long as you find that [Defendant] intended the components to be combined into a product that would have infringed the [abbreviated patent number] patent if they had been combined in the United States.

35 U.S.C. § 271(f)(2); *Cardiac Pacemakers, Inc. v. St. Jude Medical, Inc.* 576 F.3d 1348, 1359-67 (Fed. Cir. 2009); *Microsoft Corp. v. AT&T Corp.*, 550 U.S. 437, 453-56 (2007); *Waymark Corp. v. Porta Sys. Corp.*, 245 F.3d 1364, 1367-69 (Fed. Cir.

2001); *Rotec Indus., Inc. v. Mitsubishi Corp.*, 215 F.3d 1246, 1257-58 (Fed. Cir. 2000)

3.14 Infringement by Import, Sale, Offer for Sale or Use of Product Made by Patented Process (§ 271(g))

[Plaintiff] asserts that [Defendant] infringed the [abbreviated patent number] patent by [importing][selling][offering for sale][using] a product that was made by a process covered by one or more claims of the [abbreviated patent number] patent.

To show infringement under Section 271(g), [the Plaintiff] must prove that each of the following is more likely than not:

1. [the Defendant] [imported][sold][offered for sale][used] a product that was made by a process that includes all steps of at least one claim of the [abbreviated patent number] patent;
2. the product was made between [issue date of patent] and [expiration date of patent][date of trial];
3. [the Defendant] [imported][sold][offered for sale][used] the product between [issue date of patent] and [expiration date of patent][date of trial].

You must decide whether the evidence presented at trial establishes that the product [imported][sold][offered for sale][used] by the Defendant was “made by” the patented process. However, if you find that either: (a) the product [imported][sold][offered for sale][used] was materially changed by later processes, or (b) the product is only a trivial or non-essential part of another product, you must find that the product [imported][sold][offered for sale][used] by the Defendant was not “made by” by the patented process.³⁷

35 U.S.C. § 271(g); *Amgen Inc., v. F. Hoffman-La Roche Ltd.*, 580 F.3d 1340 (Fed. Cir. 2009); *Mycogen Plant Sci., Inc. v. Monsanto Co.*, 252 F.3d 1306 (Fed. Cir. 2001); *Biotec Biologische Naturvenpackungen GmbH v. BioCorp., Inc.*, 249 F.3d 1341 (Fed. Cir. 2001); *Eli Lilly & Co. v. American Cyanamid Co.*, 82 F.3d 1568 (Fed. Cir. 1996); *Bio-Technology Gen. Corp. v. Genentech, Inc.*, 80 F.3d 1553 (Fed. Cir. 1996).

4. Summary of Invalidity Defense

[The Defendant] contends that the asserted claim[s] of the patent[s]-in-suit are invalid. [The Defendant] must prove that it is highly probable that each asserted claim is invalid.

³⁷ In cases where the patentee is unable to determine the process by which the product at issue is made, and the prerequisites of 35 U.S.C. § 295 are satisfied, the presumption of Section 295 may also need to be included in this instruction, requiring the accused infringer to rebut a presumption that the product was made by the patented process.

Appendix E: Model Patent Jury Instructions

Claims of an issued patent may be found to be invalid. Thus, you must determine whether each of [the Plaintiff]'s claims is invalid.

[The Defendant] contends that patent claims [insert claim numbers] are invalid for the following reasons:

[Insert invalidity contentions]

I will now instruct you in more detail why [the Defendant] alleges that the asserted claim[s] of the [abbreviated patent numbers] is/are invalid.

Practice Note: Jury Instructions on prior art are always complex and potentially confusing. Following implementation of the AIA, different legal principles are applicable to pre-AIA and post-AIA claims, requiring multiple instructions on similar issues, under different controlling legal principles. Consideration should be given by the Court whether to bifurcate the issues of validity of pre-AIA claims from post-AIA claims, or to separately instruct and have the jury deliberate to a verdict on these issues, in order to avoid undue burden and jury confusion. At a minimum, the issues that the jury needs to decide must be clearly identified and the instructions limited to these issues.

5. Prior Art

5.0 Prior Art Defined (For patent claims having a priority date before March 16, 2013)

Prior art includes any of the following items received into evidence during trial:

1. any [product] [method] that was publicly known or used by others in the United States before the patented invention was made;
2. patents that issued more than one year before the filing date of the patent, or before the invention was made;
3. publications having a date more than one year before the filing date of the patent, or before the invention was made;
4. any [product] [method] that was in public use or on sale in the United States more than one year before the patent was filed;
5. any [product] [method] that was made by anyone before the named inventors created the patented [product] [method] where the [product] [method] was not abandoned, suppressed, or concealed.

In this case, [the Defendant] contends that the following items are prior art:

[Identify the prior art admitted into evidence by name]

35 U.S.C. § 102 (pre-AIA).

5.0 Prior Art Defined (For patent claims having a priority date after March 16, 2013)

1. any claimed invention that was patented, described in a printed publication, or in public use, on sale, or otherwise available to the public anywhere in the world before the effective filing date of the current patent; or
2. any claimed invention that was described in a patent, or in an application for patent published or deemed published, in which the patent or application names another inventor and was filed before the effective filing date of the current patent;

Exceptions to Prior Art:

1. A disclosure made 1 year or less before the effective filing date of the current claim[s] shall not be prior art to claim[s] _____ of the [abbreviated patent number] patent if:
 - A. the disclosure was made by the inventor or joint inventor named in the current patent or by another person who obtained the subject matter disclosed directly or indirectly from such inventor; or
 - B. the subject matter disclosed had, before such disclosure, been publicly disclosed by the inventor or another person who obtained the subject matter disclosed directly or indirectly from such inventor.
2. A disclosure shall not be prior art to claim[s] _____ of the [abbreviated patent number] if:
 - A. the subject matter disclosed was obtained directly or indirectly from the inventor or joint inventor named in the [abbreviated patent number] patent;
 - B. the subject matter disclosed had, before the effective filing date of the current patent, been publicly disclosed by the inventor or joint inventor named in the [abbreviated patent number] patent or another person who obtained the subject matter disclosed directly or indirectly from such inventor; or
 - C. the subject matter disclosed and the claimed invention, not later than the effective filing date of the [abbreviated patent number] patent, were owned by the same person or subject to an obligation of assignment to the same person.

Practice Note: While AIA § 102(a) does not use the term “disclosure,” that section expressly identifies as “prior art” things existing before the effective filing date of the application claiming the invention that have been: (i) patented, (ii) described in a printed publication, (iii) in public use, (iv) on sale, or (v) otherwise available to the public. The term “disclosure” is used in AIA § 102(b) to describe “exceptions” to one of the disclosure means identified in AIA § 102(a) which made the claimed invention (or elements thereof) publicly accessible. This is consistent with the USPTO’s AIA Examination Guidelines, 78 Fed. Reg. 11059, Feb. 14, 2013. Some commentators still question whether the AIA repudiated the doctrine of *Metallizing Engineering Co. v. Kenyon Bearing & Auto Parts*, 153 F.2d 516 (2d Cir. 1945), which barred patentability where an inventor/patentee (but not third parties) secretly, but commercially, practiced a claimed invention more than one year before its filing date

In this case, [the Defendant] contends that the following items are prior art:
[identify prior art by name]

35 U.S.C. § 102 as amended by the Leahy-Smith America Invents Act of 2011.

COMMENTS:

“Effective filing date” is defined under 35 U.S.C. § 100(i).

Practice Note: The issues on which the jury is being asked to make factual findings should be identified clearly and concisely. For example, if the parties dispute the status of a reference as prior art due to its date, public availability, or other factors, these issues should be identified clearly to the jury in the instructions in order to avoid jury confusion.

5.1 Prior Art Considered or Not Considered by the USPTO

Regardless whether particular prior art reference[s] was/were considered by the USPTO Examiner during the prosecution of the application which matured into the [the abbreviated number] patent, [the Defendant] must prove that the challenged claim[s] is/are invalid. [The Defendant] must do so by clear and convincing evidence. This burden of proof on [the Defendant] never changes regardless whether or not the Examiner considered the reference.

Microsoft Corp. v. i4i Ltd. P’ship., 564 U.S. ___, 131 S. Ct. 2238, 2251 (2011); *Sciele Pharma Inc. v. Lupin LTD*, 684 F.3d 1253, 1260 (Fed. Cir. 2012); *SIBIA Neurosciences, Inc. v. Cadus Pharm. Corp.*, 225 F.3d 1349, 1355-56 (Fed. Cir. 2000); *Grp. One, Ltd. v. Hallmark Cards, Inc.*, 407 F.3d 1297, 1306 (Fed. Cir. 2005).

5.2 Invalidity of Independent and Dependent Claims

There are two different types of claims in the patent. One type is called an independent claim. The other is called a dependent claim.

An independent claim does not refer to any other claim of the patent. For example, [Independent Claim] is an independent claim. An independent claim must be read separately from the other claims to determine the scope of the claim.

A dependent claim refers to at least one other claim in the patent. For example, [Dependent Claim] is a dependent claim that refers to claim [Independent Claim]. A dependent claim includes all of the elements recited in the dependent claim, as well as all of the elements of [Independent Claim] the claim to which it refers.

[IDENTIFY THE DIFFERENCES BETWEEN [Independent Claim] AND [Dependent Claim]]. [Dependent Claim] requires each of the elements of [Dependent Claim], as well as all of the additional elements of [Independent Claim].

You must evaluate the invalidity of each asserted claim separately. Even if an independent claim is invalid, this does not mean that the dependent claims that depend from it are automatically invalid. Rather, you must consider the validity of each claim, separately. You must decide this issue of validity on a claim-by-claim basis. However, if you find that a dependent claim is invalid, then you must find that the independent claim from which it depends is also invalid. The dependent claim includes all of the elements of the independent claim from which it depends.

Comaper Corp. v. Antec. Inc., 596 F.3d 1343, 1350 (Fed. Cir. 2010); *Callaway Golf Co. v. Acushnet Co.*, 576 F.3d 1331, 1344 (Fed. Cir. 2009); *Ormco Corp. v. Align Tech., Inc.*, 498 F.3d 1307, 1319 (Fed. Cir. 2007).

5.3 Person of Ordinary Skill in the Art (For patent claims having a priority date before March 16, 2013)

The question of invalidity of a patent claim is determined from the perspective of a person of ordinary skill in the art in the field of the asserted invention as of [date].

You must determine the level of ordinary skill in the field of the invention. The higher the level of ordinary skill, the easier it may be to establish that an invention would have been obvious. Persons having a greater level of education, training, or experience in the field will more readily appreciate technical details that may be more challenging for persons having a lower level of skill. On the other hand, persons having a lower level of skill may not perceive as obvious technical details that would be apparent to persons having greater skill. In order to determine the obviousness of the invention you will be asked to determine what the ordinary level of skill was in the field of the invention. Regardless whether you decide to articulate in your verdict what you believe was the level of ordinary skill in the field of the in-

vention, you must consider and assess this factor before reaching your conclusion in this case.

35 U.S.C. § 103 (pre-AIA).

5.3 Person of Ordinary Skill in the Art (For patent claims having a priority date on or after March 16, 2013)

The question of invalidity of a patent claim is determined from the perspective of a person of ordinary skill in the art in the field of the asserted invention as of [the effective filing date of the patent(s)].

You must determine the level of ordinary skill in the field of the invention. In order to determine the obviousness of the invention you will be asked to determine what the ordinary level of skill was in the field of the invention. Regardless whether you decide to articulate in your verdict what you believe was the level of ordinary skill in the field of the invention, you must consider and assess this factor before reaching your conclusion in this case.

35 U.S.C. § 103 as amended by the Leahy-Smith America Invents Act of 2011.

6. Anticipation

6.0 Anticipation

If a device or process has been previously invented and disclosed to the public, then it is not new, and therefore the claimed invention is “anticipated” by the prior invention. Simply put, the invention must be new to be entitled to patent protection under the U.S. patent laws. To prove anticipation, [the Defendant] must prove by clear and convincing evidence, namely, evidence that leaves you with a clear conviction, that the claimed invention is not new.

In this case, [the Defendant] contends that [some/all of] the claims of the [abbreviated patent number] patent are anticipated. [DESCRIBE BRIEFLY EACH BASIS FOR THE DEFENDANT’S INVALIDITY DEFENSE, FOR EXAMPLE: “First, [the Defendant] contends that the invention of claims 1, 2, and 3 of the ____ patent was described in the July, 1983 article published by Jones in THE JOURNAL OF ENDOCRINOLOGY.”]

To anticipate a claim, each and every element in the claim must be present in a single item of prior art, and arranged or combined in the same way as recited in the claim. You may not combine two or more items of prior art to find anticipation. In determining whether every one of the elements of the claimed invention is found in the prior [[publication] [patent] [etc.]], you should take into account what a person of ordinary skill in the art would have understood from his or her review of the particular [[publication] [patent] [etc.]].

<p>Practice Note: If one or more elements of the claim are alleged by the Defendant to be inherent in a single prior art reference, the jury will</p>
--

need to be instructed on inherency. Care should be taken to limit this instruction as appropriate to the evidence admitted in the case and to make this instruction as clear as possible. This Instruction should be given only if the issue is properly before the Court.

Inherency: In determining whether the single item of prior art anticipates a patent claim, you should take into consideration not only what is expressly disclosed in the particular prior art reference [[publication] [invention] [etc.]] but also what is inherently present or disclosed in that prior art or inherently results from its practice. Prior art inherently anticipates a patent claim if the missing element or feature would necessarily result from what the prior art teaches to persons of ordinary skill in the art. A party claiming inherent anticipation must prove by clear and convincing evidence that the allegedly inherent element necessarily is present. Evidence outside of the prior art reference itself [including experimental testing] may be used to show that elements that are not expressly disclosed in the reference are inherent in it. In order to be inherent, the feature that is alleged to have been inherent must necessarily have existed in the prior art reference. The fact that it was likely is not sufficient. It is not required, however, that persons of ordinary skill actually recognized or appreciated the inherent disclosure at the time the prior art was first known or used. Thus, the prior use of the patented invention that was unrecognized and unappreciated can still be an invalidating anticipation, provided the allegedly inherent feature was necessarily present in the reference.

You must keep these requirements in mind and apply them to each kind of anticipation you consider in this case. There are additional requirements that apply to the particular categories of anticipation that [the Defendant] contends apply in this case. I will now instruct you about these.

Net MoneyIN, Inc. v. Verisign, Inc., 545 F.3d 1359, 1369-70 (Fed. Cir. 2008); *Toro Co. v. Deere & Co.*, 355 F.3d 1313, 1320-21 (Fed. Cir. 2004); *Schering Corp. v. Geneva Pharms., Inc.*, 339 F.3d 1373, 1377-78 (Fed. Cir. 2003); *In re Robertson*, 169 F.3d 743, 745 (Fed. Cir. 1999); *Atlas Powder Co. v. IRECO Inc.*, 190 F.3d 1342, 1347-48 (Fed. Cir. 1999); *Glaverbel Societe Anonyme v. Northlake Mktg. & Supply, Inc.*, 45 F.3d 1550, 1554 (Fed. Cir. 1995); *Minn. Mining & Mfg. Co. v. Johnson & Johnson Orthopaedics, Inc.*, 976 F.2d 1559, 1565 (Fed. Cir. 1992); *Cont'l Can Co. USA v. Monsanto Co.*, 948 F.2d 1264, 1267-69 (Fed. Cir. 1991); *Buildex, Inc. v. Kason Indus., Inc.*, 849 F.2d 1461, 1463 (Fed. Cir. 1988).

6.1 Prior Public Knowledge (Pre-AIA)

[The Defendant] contends that claim _____ of the [abbreviated patent number] patent was anticipated because the invention defined in that claim was publicly known by others in the United States before it was invented by the inventor(s).

Practice Note: If there is a factual issue to be resolved by the jury as to the date of invention, the jury should be instructed here as to how they should determine the date of invention. Otherwise, the Court should instruct the jury as follows: “The invention defined by claim _____ of the [abbreviated patent number] patent was invented on [invention date].”

A patent claim is invalid if the invention defined in that claim was publicly known by others in the United States before it was invented by [the patentee].

35 U.S.C. § 102(a) (pre-AIA); *Minnesota Mining and Manuf. Co. v. Chemque, Inc.*, 303 F.3d 1294, 1301, 1306 (Fed. Cir. 2002); *Ecolochem, Inc. v. Southern Cal. Edison Co.*, 227 F.3d 1361, 1369 (Fed. Cir. 2000); *Woodland Trust v. Flowertree Nursery*, 148 F.3d 1368, 1370 (Fed. Cir. 1998).

6.1 Prior Public Knowledge (Post-AIA):

[The Defendant] contends that claim _____ of the [abbreviated patent number] patent was anticipated because the invention defined in that claim was available to the public before the effective filing date of the claimed invention.

Practice Note: If there is a factual issue to be resolved by the jury as to whether the prior public knowledge is the result of a disclosure made within one (1) year or less of the effective filing date by the inventor, or by another who obtained the subject matter disclosed directly from the inventor, or is subject matter which had previously been disclosed by the inventor, the jury should be instructed here as to exceptions under § 102(b).

You are instructed that the [abbreviated patent number] patent has an effective filing date of [effective filing date].

A patent claim is invalid if the invention defined in that claim was available to the public before the effective filing date of the claimed invention.

35 U.S.C. § 102(a)(1) (post-AIA); *Minnesota Mining and Manuf. Co. v. Chemque, Inc.*, 303 F.3d 1294, 1301, 1306 (Fed. Cir. 2002); *Ecolochem, Inc. v. Southern Cal. Edison Co.*, 227 F.3d 1361, 1369 (Fed. Cir. 2000); *Woodland Trust v. Flowertree Nursery*, 148 F.3d 1368, 1370 (Fed. Cir. 1998).

6.2 Prior Public Use (Pre-AIA):

[The Defendant] contends that claim _____ of the [abbreviated patent number] patent was anticipated because the invention defined in that claim [was publicly used by others in the United States before it was invented by [the patentee]] [was

publicly used in the United States more than one year before [the patentee] filed his patent application on [effective filing date]].

Practice Note: If there is a factual issue to be resolved by the jury as to the date of invention of the patent claims in suit, the jury should be instructed here as to how they should determine that date of invention. Otherwise, the Court should instruct the jury as follows: “The invention defined by claim _____ of the [abbreviated patent number] patent was invented on [invention date].”

A patent claim is invalid if more than one year before the filing date of the patent an embodiment of the claimed invention was both:

1. accessible to the public or commercially exploited in the United States; and
2. ready for patenting.

An invention was in public use if the claimed invention was accessible to the public or commercially exploited. Factors relevant to determining whether a use was public include: the nature of the activity that occurred in public; public access to the use; confidentiality obligations imposed upon observers; commercial exploitation; and the circumstances surrounding testing and experimentation.

An invention is publicly used if it is used by the inventor or by a person who is not under any limitation, restriction, or obligation of secrecy to the inventor. The absence of affirmative steps to conceal the use of the invention is evidence of a public use. However, secret use by a third party is not public, unless members of the public or employees of the third party have access to the invention.

In order to be a public use, the invention also must have been ready for patenting at the time of the alleged public use. An invention is ready for patenting either when it is reduced to practice or when the inventor has prepared drawings or other descriptions of the invention sufficient to allow a person of ordinary skill in the art to make or use the invention. An invention is reduced to practice when it has been: (1) constructed or performed within the scope of the patent claims; and (2) determined that it works for its intended purpose. The claimed invention is ready for patenting when there is reason to believe it would work for its intended purpose.

35 U.S.C. § 102(a), (b) (pre-AIA); *Clock Spring, L.P. v. Wrapmaster, Inc.*, 560 F.3d 1317, 1325-27 (Fed. Cir. 2009); *American Seating Co. v. USSC Grp., Inc.*, 514 F.3d 1262, 1267 (Fed. Cir. 2008); *Invitrogen Corp. v. Biocrest Manuf., L.P.*, 424 F.3d 1374, 1379-82 (Fed. Cir. 2005); *SmithKline Beecham Corp. v. Apotex Corp.*, 365 F.3d 1306, 1316-20 (Fed. Cir. 2004); *Netscape Commc’ns Corp. v. Konrad*, 295 F.3d 1315, 1320-23 (Fed. Cir. 2002); *Cooper v. Goldfarb*, 154 F.3d 1321, 1327 (Fed. Cir. 1998) (as to reduction to practice); *Grain Processing Corp. v. Am. Maize Prods. Co.*, 840 F.2d 902, 906 (Fed. Cir. 1988); *Moleculon Research Corp. v. CBS, Inc.*, 793 F.2d 1261, 1265-67 (Fed. Cir. 1986); *Kinzenbaw v. Deere & Co.*, 741 F.2d 383, 390-91 (Fed. Cir. 1984); *TP Lab., Inc. v. Prof’l Positioners, Inc.*, 724 F.2d 965,

970-72 (Fed. Cir. 1984); *WL Gore & Assocs., Inc. v. Garlock, Inc.*, 721 F.2d 1540, 1549-50 (Fed. Cir. 1983); *In re Smith*, 714 F.2d 1127, 1134-37 (Fed. Cir. 1983).

6.2 Prior Public Use (Post-AIA):

[The Defendant] contends that claim ____ of the [abbreviated patent number] patent was anticipated because the invention defined in that claim was in public use anywhere in the world before the effective filing date of the claimed invention.

Practice Note: If there is a factual issue to be resolved by the jury as to whether the prior public use is the result of a disclosure made within one (1) year or less of the effective filing date by the inventor, or by another who obtained the subject matter disclosed directly from the inventor, or subject matter which had previously been disclosed by the inventor, the jury should be instructed here as to exceptions under § 102(b).

You are instructed that the [abbreviated patent number] patent has an effective filing date of [effective filing date].

A patent claim is invalid if the claimed invention was in public use before the effective filing date of the claimed invention.

An invention was in public use if the claimed invention was accessible to the public or commercially exploited anywhere in the world. Factors relevant to determining whether a use was public include the nature of the activity that occurred in public; public access to the use; confidentiality obligations imposed upon observers; commercial exploitation; and the circumstances surrounding testing and experimentation. An invention is publicly used if it is used by the inventor or by a person who is not under any limitation, restriction, or obligation of secrecy to the inventor. The absence of affirmative steps to conceal the use of the invention is evidence of a public use. However, secret use by a third party is not public, unless members of the public or employees of the third party have access to the invention.

In order to be a public use, the invention also must have been ready for patenting at the time of the alleged public use. An invention is ready for patenting either when it is reduced to practice or when the inventor has prepared drawings or other descriptions of the invention sufficient to allow a person of ordinary skill in the art to make or use the invention. An invention is reduced to practice when it has been: (1) constructed or performed within the scope of the patent claims; and (2) determined that it works for its intended purpose. The claimed invention is ready for patenting when there is reason to believe it would work for its intended purpose.

35 U.S.C. § 102(a)(2) (post-AIA); *Clock Spring, L.P. v. Wrapmaster, Inc.*, 560 F.3d 1317, 1325-27 (Fed. Cir. 2009); *American Seating Co. v. USSC Grp., Inc.*, 514 F.3d 1262, 1267 (Fed. Cir. 2008); *Invitrogen Corp. v. Biocrest Manuf., L.P.*, 424 F.3d 1374, 1379-82 (Fed. Cir. 2005); *SmithKline Beecham Corp. v. Apotex Corp.*, 365

F.3d 1306, 1316-20 (Fed. Cir. 2004); *Netscape Commc'ns Corp. v. Konrad*, 295 F.3d 1315, 1320-23 (Fed. Cir. 2002); *Grain Processing Corp. v. Am. Maize-Prods. Co.*, 840 F.2d 902, 906 (Fed. Cir. 1988); *Moleculon Research Corp. v. CBS, Inc.*, 793 F.2d 1261, 1265-67 (Fed. Cir. 1986); *Kinzenbaw v. Deere & Co.*, 741 F.2d 383, 390-91 (Fed. Cir. 1984); *TP Lab., Inc. v. Prof'l Positioners, Inc.*, 724 F.2d 965, 970-72 (Fed. Cir. 1984); *WL Gore & Assocs., Inc. v. Garlock, Inc.*, 721 F.2d 1540, 1549-50 (Fed. Cir. 1983); *In re Smith*, 714 F.2d 1127, 1134-37 (Fed. Cir. 1983).

6.3 On Sale Bar (Pre-AIA):

[The Defendant] contends that claim _____ of the [abbreviated patent number] patent was anticipated because the invention defined in that claim was on sale in the United States more than one year before [the patentee] filed his U.S. patent application on [U.S. filing date].

A patent claim is invalid if more than one year before the filing date of the patent an embodiment of the claimed invention was both: (1) subject to commercial offer for sale in the United States; and (2) ready for patenting.

A commercial “offer for sale” was made if another party could make a binding contract by simply accepting the offer. An invention was subject to an “offer for sale” if the claimed invention was embodied in an item that was actually sold or offered for sale. It is not required that a sale was actually made. The essential question is whether there was an attempt to obtain a commercial benefit from the invention.

The invention also must have been “ready for patenting” more than one year before the filing date of the patent. An invention is ready for patenting either when it is reduced to practice or when the inventor has prepared drawings or other descriptions of the invention that were sufficiently specific to enable a person of ordinary skill in the art to practice the invention. An invention is reduced to practice when it has been (1) constructed or performed within the scope of the patent claims; and (2) determined that it works for its intended purpose. The claimed invention is ready for patenting when there is reason to believe it would work for its intended purpose.

35 U.S.C. § 102(b) (pre-AIA); *Pfaff v. Wells Elecs.*, 525 U.S. 55, 67-68 (1998); *August Tech v. Camtek*, 655 F.3d 1278, 1288-89 (Fed. Cir. 2011); *Atlanta Attachment Co., v. Leggett & Platt, Inc.*, 516 F.3d 1361, 1365 (Fed. Cir. 2008); *Board of Educ. ex rel Bd. Of Trustees of Florida State University v. American Bioscience, Inc.*, 333 F.3d 1330, 1338 (Fed. Cir. 2003) (as to conception); *Allen Eng'g Corp. v. Bartell Indus., Inc.*, 299 F.3d 1336, 1352-55 (Fed. Cir. 2002); *Linear Tech. Corp. v. Micrel, Inc.*, 275 F.3d 1040, 1047-54 (Fed. Cir. 2001); *Robotic Vision Sys., Inc., v. View Eng'g, Inc.*, 249 F.3d 1307, 1312 (Fed. Cir. 2001); *Grp. One, Ltd. v. Hallmark Cards, Inc.*, 254 F.3d 1041, 1045-49 (Fed. Cir. 2001); *Cooper v. Goldfarb*, 154 F.3d 1321, 1327 (Fed. Cir. 1998) (as to reduction to practice).

6.3 On Sale Bar (Post-AIA):

[The Defendant] contends that claim _____ of the [abbreviated patent number] patent was anticipated because the invention defined in that claim was on sale before the effective filing date of the claimed invention.

You are instructed that the [abbreviated patent number] patent has an effective filing date of [effective filing date].

A patent claim is invalid if it was on sale before the effective filing date of the claimed invention.

A commercial “offer for sale” was made if another party could make a binding contract by simply accepting the offer. An invention was subject to an “offer for sale” if the claimed invention was embodied in an item that was actually sold or offered for sale. It is not required that a sale was actually made. The essential question is whether there was an attempt to obtain a commercial benefit from the invention.

A commercial “offer for sale” was made by the inventor both:

1. if the claimed invention was embodied in an item that was actually sold or offered for sale; and
2. the invention was “ready for patenting”

more than one year before the effective filing date of the claimed invention. An invention is ready for patenting either when it is reduced to practice or when the inventor has prepared drawings or other descriptions of the invention that was sufficiently specific to enable a person of ordinary skill in the art to practice the invention. An invention is reduced to practice when it has been: (1) constructed or performed within the scope of the patent claims; and (2) determined that it works for its intended purpose. The claimed invention is ready for patenting when there is reason to believe it would work for its intended purpose.

35 U.S.C. § 102(a)(1) (post-AIA); *Pfaff v. Wells Elecs.*, 525 U.S. 55, 67-68 (1998); *August Tech v. Camtek*, 655 F.3d 1278, 1288-89 (Fed. Cir. 2011); *Atlanta Attachment Co., v. Leggett & Platt, Inc.*, 516 F.3d 1361, 1365 (Fed. Cir. 2008); *Board of Educ. ex rel Bd. Of Trustees of Florida State University v. American Bioscience, Inc.*, 333 F.3d 1330, 1338 (Fed. Cir. 2003) (as to conception); *Allen Eng’g Corp. v. Bartell Indus., Inc.*, 299 F.3d 1336, 1352-55 (Fed. Cir. 2002); *Linear Tech. Corp. v. Micrel, Inc.*, 275 F.3d 1040, 1047-54 (Fed. Cir. 2001); *Robotic Vision Sys., Inc., v. View Eng’g, Inc.*, 249 F.3d 1307, 1312 (Fed. Cir. 2001); *Grp. One, Ltd. v. Hallmark Cards, Inc.*, 254 F.3d 1041, 1045-49 (Fed. Cir. 2001); *Cooper v. Goldfarb*, 154 F.3d 1321, 1327 (Fed. Cir. 1998) (as to reduction to practice).

6.4 Experimental Use

[The Plaintiff] contends that _____ should not be considered [[a prior public use of the invention] [placing the invention on sale]] because that [[use] [sale]] was experimental. The law recognizes that the inventor must be

given the opportunity to develop the invention through experimentation. Certain activities are experimental if they are a legitimate effort to test claimed features of the invention or to determine if the invention will work for its intended purpose. So long as the primary purpose is experimentation, it does not matter that the public used the invention or that the inventor incidentally derived profit from it.

Only experimentation by or under the control of the inventor of the patent [or his assignee] qualifies for this exception. Experimentation by [third party], for its own purposes, does not. The experimentation must relate to the features of the claimed invention, and it must be for the purpose of technological improvement, not commercial exploitation. If any commercial exploitation does occur, it must be merely incidental to the primary purpose of experimentation. A test done primarily for marketing, and only incidentally for technological improvement, is not an experimental use.

If you find that [the Defendant] has shown by clear and convincing evidence that there was a [[prior public use] [prior sale]], then the burden is on [the Plaintiff] to come forward with evidence showing that the purpose of [the prior public use] [prior sale] was experimental. If the evidence of the experimental use produced by [the Plaintiff] is strong enough that you find that [the Defendant] has not met its burden of establishing a [[prior public use][prior sale]] by clear and convincing evidence, you may find that _____ does not constitute [[a prior public use of the invention][placing the invention on sale]].

City of Elizabeth v. Am. Nicholson Pavement Co., 97 U.S. 126, 134-35 (1877); *Clock Spring, L.P. v. Wrapmaster, Inc.*, 560 F.3d 1317, 1327 (Fed. Cir. 2009); *Lisle Corp. v. A.J. Mfg. Co.*, 398 F.3d 1306, 1316 (Fed. Cir. 2005); *Allen Eng'g Corp. v. Bartell Indus., Inc.*, 299 F.3d 1336, 1353-55 (Fed. Cir. 2002); *LaBounty Mfg., Inc. v. U.S. Int'l Trade Comm'n*, 958 F.2d 1066, 1071-72 (Fed. Cir. 1992); *Manville Sales Corp. v. Paramount Sys., Inc.*, 917 F.2d 544, 549-51 (Fed. Cir. 1990); *U.S. Envtl. Prods. Inc. v. Westall*, 911 F.2d 713, 716 (Fed. Cir. 1990); *In re Hamilton*, 882 F.2d 1576, 1580-83 (Fed. Cir. 1989); *Grain Processing Corp. v. Am. Maize-Prods. Co.*, 840 F.2d 902, 906 (Fed. Cir. 1988); *Hycor Corp. v. Schlueter Co.*, 740 F.2d 1529, 1535-37 (Fed. Cir. 1984); *Pennwalt Corp. v. Akzona Inc.*, 740 F.2d 1573, 1580-81 (Fed. Cir. 1984); *In re Smith*, 714 F.2d 1127, 1134-37 (Fed. Cir. 1983).

6.5 Printed Publication (Pre-AIA):

[The Defendant] contends that claim _____ of the [abbreviated patent number] patent was anticipated because the invention defined in that claim was described in a printed publication [[more than one year before [the patentee] filed the U.S. patent application on [U.S. filing date]] [before [the patentee] invented the invention]].

A patent claim is invalid if the invention defined by that claim was described in a printed publication [[before it was invented by [the patentee]] [more than one year prior to the filing date of the U.S. application]].

Practice Note: If there is a factual issue to be resolved by the jury as to the date of invention of the patent claims in suit, the jury should be instructed here as to how they should determine that date of invention. Otherwise, the Court should instruct the jury as follows: “The invention defined by claim _____ of the [abbreviated patent number] patent was invented on [invention date].”

A printed publication must have been maintained in some tangible form, such as [[printed pages] [typewritten pages] [magnetic tape] [microfilm] [photographs] [internet publication] [photocopies]], and must have been sufficiently accessible to persons interested in the subject matter of its contents.

Practice Note: In the event accessibility is disputed, it is appropriate to give the following additional Instruction.

Information is publicly accessible if it was distributed or otherwise made available to the extent that persons interested and ordinarily skilled in the subject matter exercising reasonable diligence can locate it. It is not necessary for the printed publication to have been available to every member of the public. An issued patent is a printed publication. A published patent application is a printed publication as of its publication date.

The disclosure of the claimed invention in the printed publication must be complete enough to enable one of ordinary skill in the art to use the invention without undue experimentation. In determining whether the disclosure is enabling, you should take into account what would have been within the knowledge of a person of ordinary skill in the art [[one year before the application for the [abbreviated patent number] patent was filed] [at the time the invention of the [abbreviated patent number] patent was made]], and you may consider evidence that sheds light on the knowledge such a person would have had.

35 U.S.C. § 102(a), (b) (pre-AIA); *In re NTP, Inc.*, 654 F.3d 1279, 1296-97 (Fed. Cir. 2011); *Orion IP v. Hyundai Motor America*, 605 F.3d 967 (Fed. Cir. 2010); *In re Lister*, 583 F.3d 1307, 1311-12 (Fed. Cir. 2009); *Kyocera Wireless Corp. v. Int’l Trade Comm.*, 545 F.3d 1340, 1350 (Fed. Cir. 2008); *Finisar Corp. v. DirectTV Grp., Inc.*, 523 F.3d 1323, 1334 (Fed. Cir. 2008); *SRI Int’l, Inc. v. Internet Sec. Sys., Inc.*, 511 F.3d 1186 (Fed. Cir. 2008); *In re Klopfenstein*, 380 F.3d 1345, 1352 (Fed. Cir. 2004); *Glaverbel Societe Anonyme v. Northlake Mktg. & Supply, Inc.*, 45 F.3d 1550, 1554-55 (Fed. Cir. 1995); *Scripps Clinic & Research Found. v. Genentech, Inc.*, 927 F.2d 1565, 1576 (Fed. Cir. 1991); *Constant v. Advanced Micro-Devices, Inc.*, 848 F.2d 1560, 1568-69 (Fed. Cir. 1988); *Akzo N.V. v. U.S. Int’l Trade Comm’n*, 808 F.2d 1471, 1479 (Fed. Cir. 1986); *In re Hall*, 781 F.2d 897, 898-899 (Fed. Cir. 1986); *In re Donohue*, 766 F.2d 531, 533-34 (Fed. Cir. 1985); *Studiengesellschaft Kohle mbH v. Dart Indus., Inc.*, 726 F.2d 724, 727 (Fed. Cir. 1984).

6.5 Printed Publication (Post-AIA):

[The Defendant] contends that claim _____ of the [abbreviated patent number] patent was anticipated because the invention defined in that claim was described in a printed publication before the effective filing date of the claimed invention.

You are instructed that the [abbreviated patent number] patent has an effective filing date of [effective filing date].

Practice Note: If there is a factual issue to be resolved by the jury as to whether the printed publication is the result of a disclosure made within one (1) year or less of the effective filing date by the inventor, or by another who obtained the subject matter disclosed directly from the inventor, or subject matter which had previously been disclosed by the inventor, the jury should be instructed here as to exceptions under § 102(b)(1).

A patent claim is invalid if the invention defined by that claim was described in a printed publication before the effective filing date of the claimed invention.

A printed publication must have been maintained in some tangible form, such as [[printed pages] [typewritten pages] [magnetic tape] [microfilm] [photographs] [internet publication] [photocopies]], and must have been sufficiently accessible to persons interested in the subject matter of its contents .

Practice Note: In the event accessibility is disputed, it is appropriate to give the following additional instruction on this issue.

Information is publicly accessible if it was distributed or otherwise made available to the extent that persons interested and ordinarily skilled in the subject matter exercising reasonable diligence can locate it. It is not necessary for the printed publication to have been available to every member of the public. An issued patent is a printed publication. A published patent application is a printed publication as of its publication date.

The disclosure of the claimed invention in the printed publication must be complete enough to enable one of ordinary skill in the art to use the invention without undue experimentation. In determining whether the disclosure is enabling, you should take into account what would have been within the knowledge of a person of ordinary skill in the art [[one year before the application for the [abbreviated patent number] patent was filed] [at the time the invention of the [abbreviated patent number] patent was made]], and you may consider evidence that sheds light on the knowledge such a person would have had.

35 U.S.C. § 102(a)(1) & (b)(1) (post-AIA); *In re NTP, Inc.*, 654 F.3d 1279, 1296-97 (Fed. Cir. 2011); *Orion IP v. Hyundai Motor America*, 605 F.3d 967 (Fed. Cir.

2010); *In re Lister*, 583 F.3d 1307, 1311-12 (Fed. Cir. 2009); *Kyocera Wireless Corp. v. Int'l Trade Comm.*, 545 F.3d 1340, 1350 (Fed. Cir. 2008); *Finisar Corp. v. DirectTV Grp., Inc.*, 523 F.3d 1323, 1334 (Fed. Cir. 2008); *SRI Int'l, Inc. v. Internet Sec. Sys., Inc.*, 511 F.3d 1186 (Fed. Cir. 2008); *In re Klopfenstein*, 380 F.3d 1345, 1352 (Fed. Cir. 2004); *Glaverbel Societe Anonyme v. Northlake Mktg. & Supply, Inc.*, 45 F.3d 1550, 1554-55 (Fed. Cir. 1995); *Scripps Clinic & Research Found. v. Genentech, Inc.*, 927 F.2d 1565, 1576 (Fed. Cir. 1991); *Constant v. Advanced Micro-Devices, Inc.*, 848 F.2d 1560, 1568-69 (Fed. Cir. 1988); *Akzo N.V. v. U.S. Int'l Trade Comm'n*, 808 F.2d 1471, 1479 (Fed. Cir. 1986); *In re Hall*, 781 F.2d 897, 898-899 (Fed. Cir. 1986); *In re Donohue*, 766 F.2d 531, 533-34 (Fed. Cir. 1985); *Studiengesellschaft Kohle mbH v. Dart Indus., Inc.*, 726 F.2d 724, 727 (Fed. Cir. 1984).

6.6 Prior Invention (pre-AIA Only)³⁸

[The Defendant] contends that claim _____ of the [abbreviated patent number] patent was anticipated because the invention defined in that claim was invented by another person, [third party], before [the patentee] invented his invention.

A patent claim is invalid if the invention defined by that claim was invented by another person in the United States before it was invented by the patentee, [and that other person did not abandon, suppress, or conceal the invention].

[The Defendant] must show clear and convincing evidence *either* that before [the patentee] invented his invention, [third party] reduced to practice a [[product] [method]] that included all of the elements of claim ___ of the [abbreviated patent number] patent or that [third party] was first to conceive the invention and that he exercised reasonable diligence in later reducing the invention to practice. In addition, [the Defendant] must show that [third party]'s device was sufficiently developed that one skilled in the art would have recognized that it would work for its intended purpose.

<p>Practice Note: This defense may be negated if the invention was abandoned, suppressed, or concealed. In the event this issue is properly asserted and there is sufficient evidentiary support to submit this issue to the jury the following additional Instructions should be given.</p>

38. In cases where priority of invention is an issue to be submitted to the jury, further instructions will be required. For example, the jury will need to consider not only the dates when the respective inventions were conceived, but also when the inventions were reduced to practice. An inventor who claims to be the first to conceive of a prior invention but was the last to reduce to practice must also show reasonable diligence from a time just before the other party entered the field until his own reduction to practice in order for the "prior invention" to anticipate the claimed invention in suit.

If the prior invention was abandoned, suppressed, or concealed, it does not anticipate the [abbreviated patent number] patent. It is not necessary that [the patentee] had knowledge of that prior invention.³⁹

You may find that an invention was abandoned, suppressed, or concealed if you find that: (1) the prior inventor actively concealed the invention from the public; or (2) the prior inventor unreasonably delayed in making the invention publicly known. These facts must be proven by clear and convincing evidence. Generally, an invention was not abandoned, suppressed, or concealed if the invention was made public, sold, or offered for sale, or otherwise used for a commercial purpose. A period of delay does not constitute abandonment, suppression, or concealment, provided the prior inventor was engaged in reasonable efforts to bring the invention to market during this period.

35 U.S.C. § 102(a), (g) (pre-AIA); *Teva Pharm. v. Astrazeneca Pharms.*, 661 F.3d 1378 (Fed. Cir. 2011); *Solvay S.A. v. Honeywell Int'l. Inc.*, 622 F.3d 1367, 1376 (Fed. Cir. 2010); *Rosco, Inc. v. Mirror Lite Co.*, 304 F.3d 1373, 1381 (Fed. Cir. 2002); *Dow Chemical Co. v. Astro-Valcour, Inc.*, 267 F.3d 1334, 1343 (Fed. Cir. 2001); *Monsanto Co. v. Mycogen Plant Sci., Inc.*, 261 F.3d 1356, 1361-63 (Fed. Cir. 2001); *Apotex USA, Inc. v. Merck & Co.*, 254 F.3d 1031, 1035-40 (Fed. Cir. 2001); *E.I. du Pont de Nemours & Co. v. Phillips Petroleum Co.*, 849 F.2d 1430, 1436-37 (Fed. Cir.1988); *Kimberly-Clark Corp. v. Johnson & Johnson*, 745 F.2d 1437, 1444-46 (Fed. Cir. 1984).

6.6 Prior Invention (post-AIA Only)

Practice Note: The prior invention defense was eliminated by the AIA. The prior invention defense is no longer a basis for invalidity and no instruction should be given on this issue for Post-AIA claims.

6.7 Prior Patent (Pre-AIA):

[The Defendant] contends that claim _____ of the [abbreviated patent number] patent was anticipated because the invention defined in that claim was patented by [third party] [[before it was invented by [the patentee]] [more than one year before [the patentee] filed his United States patent application on [U.S. filing date]].

³⁹ If abandonment, suppression or concealment are at issue in the case, these terms should be defined for the jury. See *Dow Chem. Co. v. Astro-Valcour Inc.*, 267 F.3d 1334, 1342 (Fed. Cir. 2001); *Checkpoint Sys., Inc. v. United States Int'l Trade Comm'n*, 54 F.3d 756, 761-62 (Fed. Cir. 1995).

Appendix E: Model Patent Jury Instructions

A patent claim is invalid if the invention defined by that claim was patented in the United States or a foreign country [[before it was invented by [the patentee]] [more than one year before [the patentee] filed his United States patent application]].

Practice Note: If there is a factual issue to be resolved by the jury as to the date of invention of the patent claims in suit, the jury should be instructed here as to how they should determine that date of invention. Otherwise, the court should instruct the jury as follows: “The invention defined by claim _____ of the [abbreviated patent number] patent was invented on [invention date].”

35 U.S.C. § 102(a)-(b) (pre-AIA); *Adv. Display Sys., Inc. v. Kent State Univ.*, 212 F.3d 1272, 1287-83 (Fed. Cir. 2000); *In re Carlson*, 983 F.2d 1032, 1035-36 (Fed. Cir. 1992).

6.7 Prior Patent (Post-AIA):

[The Defendant] contends that claim _____ of the [abbreviated patent number] patent was anticipated because the invention defined in that claim was patented by [third party] before the effective filing date of the claimed invention.

Practice Note: If there is a factual issue to be resolved by the jury as to whether the disclosure appearing in a patent is the result of a disclosure made within one (1) year or less of the effective filing date by the inventor, by another who obtained the subject matter disclosed directly from the inventor, or if the subject matter disclosed and the claimed invention were owned by the same person or subject to an obligation of assignment to the same person, the jury should be instructed here as to exceptions under § 102(b)(2).

A patent claim is invalid if the invention defined by that claim was patented in the United States or a foreign country before the effective filing date of the claimed invention.

You are instructed that the [abbreviated patent number] patent has an effective filing date of [effective filing date].

You are further instructed that patent [patent number] issued to [third party] has an effective filing date of [effective filing date].

35 U.S.C. § 102(a)(1), (a)(2) & (d) (post-AIA).

6.8 Prior U.S. Application (Pre-AIA)

[The Defendant] contends that claim _____ of the [abbreviated patent number] patent was anticipated because the invention defined in that claim was described in United States [[published patent application] [patent]] [[published applica-

tion number] [anticipating patent number]], and because [[the published patent application [published application number]] [application for the [anticipating patent number] patent] was filed before [the patentee] made his invention.

A claim of the [abbreviated patent number] patent would be invalid if the invention defined by that claim was described in a [[published United States patent application] [United States patent]] filed by another person before the invention was made by [the patentee].

Practice Note: if there is a factual issue to be resolved by the jury as to the date of invention of the patent claims in suit, the jury should be instructed here as to how they should determine that date of invention. Otherwise, the court should instruct the jury as follows: “The invention defined by claim [____] of the [abbreviated patent number] patent was invented on [invention date]”

35 U.S.C. §§ 102(e)(1) and (2) (pre-AIA); *In re Giacomini*, 612 F.3d 1380, 1383-84 (Fed. Cir. 2010); *Sun Studs, Inc. v. ATA Equip. Leasing, Inc.*, 872 F.2d 978, 983-84 (Fed. Cir. 1989) (*overruled on other grounds*); *In re Wertheim*, 646 F.2d 527, 536-37 (C.C.P.A. 1981).

6.8 Prior U.S. Application (Post-AIA):

[The Defendant] contends that claim _____ of the [abbreviated patent number] patent was anticipated because the invention defined in that claim was described in a patent application [published application number] published in the United States, and because the published patent application [published application number] was filed before the effective filing date of the claimed invention.

A claim of the [abbreviated patent number] patent would be invalid if the invention defined by that claim was described in a published patent application filed by another person before the effective filing date of the claimed invention.

Practice Note: If there is a factual issue to be resolved by the jury as to whether the disclosure appearing in a patent application is the result of a disclosure made within one (1) year or less of the effective filing date by the inventor, by another who obtained the subject matter disclosed directly from the inventor, or if the subject matter disclosed and the claimed invention were owned by the same person or subject to an obligation of assignment to the same person, the jury should be instructed here as to exceptions under § 102(b)(2).

You are instructed that the [abbreviated patent number] patent has an effective filing date of [effective filing date].

You are further instructed that the published patent application [published application number] has an effective filing date of [effective filing date].

35 U.S.C. § 102(a)(2), (b)(2) & (d) (post-AIA).

7. Obviousness

Practice Note: Obviousness is a mixed question of fact and law. Failing to move for judgment as a matter of law may waive the issue of obviousness on an appeal. Careful consideration should be given to the Court’s and the Jury’s respective roles in determining this issue and the jury should be instructed accordingly.

7.0 Obviousness

[The Defendant] contends that claim(s) [numbers] of the [abbreviated patent number] patent are invalid because the claimed invention(s) is “obvious.”

A claimed invention is invalid as “obvious” if it would have been obvious to a person of ordinary skill in the art of the claimed invention at the time the invention was made. Unlike anticipation, which allows consideration of only one item of prior art, obviousness may be shown by considering more than one item of prior art.

In deciding obviousness, you must avoid using hindsight; that is, you should not consider what is known today or what was learned from the teachings of the patent. You should not use the patent as a road map for selecting and combining items of prior art. You must put yourself in the place of a person of ordinary skill in the art at the time the invention was made.

The following factors must be evaluated to determine whether [the Defendant] has established that the claimed invention(s) is obvious:

1. the scope and content of the prior art relied upon by [the Defendant];
2. the difference or differences, if any, between each claim of the [abbreviated patent number] patent that [the Defendant] contends is obvious and the prior art;
3. the level of ordinary skill in the art at the time the invention of the [abbreviated patent number] patent was made; and
4. additional considerations, if any, that indicate that the invention was obvious or not obvious.

Each of these factors must be evaluated, although they may be analyzed in any order, and you must perform a separate analysis for each of the claims.

[The Defendant] must prove by clear and convincing evidence that the invention would have been obviousness.

I will now explain each of the four factors in more detail.

KSR Int’l Co. v. Teleflex Inc., 550 U.S. 398, 405 and 421 (2007); *Graham v. John Deere Co.*, 383 U.S. 1, 17-18 (1966); *Otsuka Pharm. Co., Ltd. v. Sandoz, Inc.*, 678 F.3d 1280, 1296 (Fed. Cir. 2012); *Leapfrog Enters., Inc. v. Fisher-Price, Inc.*, 485

F.3d 1157, 1161-62 (Fed. Cir. 2007); *Ruiz v. A.B. Chance Co.*, 234 F.3d 654, 662-63 (Fed. Cir. 2000); *Arkies Lures, Inc. v. Gene Larew Tackle, Inc.*, 119 F.3d 953, 955 (Fed. Cir. 1997); *Ryko Mfg. Co. v. Nu-Star, Inc.*, 950 F.2d 714, 716 (Fed. Cir. 1991); *Nutrition 21 v. U.S.*, 930 F.2d 867, 871 n.2 (Fed. Cir. 1991); *Newell Cos. v. Kenney Mfg. Co.*, 864 F.2d 757, 764 (Fed. Cir. 1988); *Structural Rubber Prods. Co. v. Park Rubber Co.*, 749 F.2d 707, 718-19 (Fed. Cir. 1984); *Orthopedic Equip. Co. v. All Orthopedic Appliances, Inc.*, 707 F.2d 1376, 1382-83 (Fed. Cir. 1983); *Stratoflex, Inc. v. Aeroquip Corp.*, 713 F.2d 1530, 1538-40 (Fed. Cir. 1983).

7.1 The First Factor: Scope and Content of the Prior Art

The prior art that you considered previously for anticipation purposes is also prior art for obviousness purposes. The prior art includes the following items received into evidence during the trial:

[LIST PRIOR ART STIPULATED TO BY THE PARTIES].

[IF PARTIES DISPUTE THE PRIOR ART, USE THE FOLLOWING].

You must determine what is the prior art that may be considered in determining whether the [abbreviated patent number] patent is obvious. A prior art reference may be considered if it discloses information designed to solve any problem or need addressed by the patent or if the reference discloses information that has obvious uses beyond its main purpose that a person of ordinary skill in the art would reasonably examine to solve any problem or need addressed by the patent.

[ADD INSTRUCTIONS ON PRIOR ART CONTENTIONS, E.G., PUBLICATION AND ON-SALE BAR, AND INHERENCY, IF ASSERTED]

KSR Int'l Co. v. Teleflex Inc., 127 S. Ct. 1727, 1742 (2007); *Ruiz v. A.B. Chance Co.*, 234 F.3d 654, 664-65 (Fed. Cir. 2000); *Wang Labs., Inc. v. Toshiba Corp.*, 993 F.2d 858, 864 (Fed. Cir. 1993); *In re Clay*, 966 F.2d 656, 658-59 (Fed. Cir. 1992); *In re Wood*, 599 F.2d 1032, 1036-37 (C.C.P.A. 1979).

7.2 The Second Factor: Differences Between the Claimed Invention and the Prior Art

You should analyze whether there are any relevant differences between the prior art and the claimed invention from the view of a person of ordinary skill in the art at the time of the invention. Your analysis must determine the impact, if any, of such differences on the obviousness or nonobviousness of the invention as a whole, and not merely some portion of it.

Practice Note: In the event inherency is properly asserted and adequately supported by the evidence, the following instruction should be given:

“In comparing the scope and content of each prior art reference to a patent claim, you may find that inherency may supply a claim element that is otherwise missing from the explicit disclosure of a prior art reference. The

inherent presence of an element so found by you may be used in your evaluation of whether the claimed invention would have been obvious in view of the prior art. But, to rely on inherency to establish the existence of a claim limitation in the prior art in an obviousness analysis, that limitation necessarily must be present in, or the natural result of, the combination of elements explicitly disclosed by the prior art. Inherency may not be established by probabilities or possibilities. The mere fact that a certain thing *may* result from an explicit disclosure is not sufficient to find inherency. However, if the disclosure is sufficient to show that the natural result flowing from the explicit disclosure *would* result in the claim limitation in question, inherency may be found. Something inherent from the explicit disclosure of the prior art must be limited when applied in an obviousness analysis and used only when the inherent limitation is the natural result of the combination of prior art elements explicitly disclosed.”

Par Pharm., Inc. v. TWI Pharms., Inc., 773 F.3d 1186, 1194-1196 (Fed. Cir. 2014); *Alcon Research, Ltd. v. Apotex Inc.*, 687 F.3d, 1362 (Fed. Cir. 2012); *In re Kubin*, 561 F.3d 1351, 1357 (Fed. Cir. 2009); and cases cited therein.

In analyzing the relevance of the differences between the claimed invention and the prior art, you do not need to look for precise teaching in the prior art directed to the subject matter of the claimed invention. You may take into account the inferences and creative steps that a person of ordinary skill in the art would have employed in reviewing the prior art at the time of the invention. For example, if the claimed invention combined elements known in the prior art and the combination yielded results that were predictable to a person of ordinary skill in the art at the time of the invention, then this evidence would make it more likely that the claim was obvious. On the other hand, if the combination of known elements yielded unexpected or unpredictable results, or if the prior art teaches away from combining the known elements, then this evidence would make it more likely that the claim that successfully combined those elements was not obvious.

Importantly, a claim is not proved obvious merely by demonstrating that each of the elements was independently known in the prior art. Most, if not all, inventions rely on building blocks long-known, and claimed discoveries almost of necessity will likely be combinations of what is already known. Therefore, you should consider whether a reason existed at the time of the invention that would have prompted a person of ordinary skill in the art in the relevant field to combine the known elements in the way the claimed invention does. The reason could come from the prior art, the background knowledge of one of ordinary skill in the art, the nature of any problem or need to be addressed, market demand, or common sense. You may also consider whether the problem or need was known, the possible approaches to solving the problem or addressing the need were known and finite, and the solution was predictable through use of a known option.

If you find that a reason existed at the time of the invention to combine the elements of the prior art to arrive at the claimed invention, this evidence would make it more likely that the claimed invention was obvious. Again, you must undertake this analysis separately for each claim that [the Defendant] contends is obvious.

KSR Int'l Co. v. Teleflex Inc., 127 S. Ct. 1727, 1742-43 (2007); *Abbott Labs. v. Sandoz, Inc.*, 544 F.3d 1341, 1351 (Fed. Cir. 2008); *Graham v. John Deere Co.*, 383 U.S. 1, 17-18 (1966); *Stratoflex, Inc. v. Aeroquip Corp.*, 713 F.2d 1530, 1536-37 (Fed. Cir. 1983); *Medtronic, Inc., v. Cardiac Pacemakers, Inc.*, 721 F.2d 1563, 1567-68 (Fed. Cir. 1983).

7.3 The Third Factor: Level of Ordinary Skill

The determination of whether a claimed invention is obvious is based on the perspective of a person of ordinary skill in the [pertinent art field]. The person of ordinary skill is presumed to know all prior art that you have determined to be reasonably relevant. The person of ordinary skill is also a person of ordinary creativity that can use common sense to solve problems.

[If the parties have agreed to the level of ordinary skill in the art, then the instruction should include: “[The Plaintiff] and [the Defendant] contend that the level of ordinary skill in the art is [insert proposal].”]

[If the parties have not agreed to the level of ordinary skill in the art, then the instruction should continue as follows].

When determining the level of ordinary skill in the art, you should consider all the evidence submitted by the parties, including evidence of:

1. the level of education and experience of persons actively working in the field at the time of the invention, including the inventor;
2. the types of problems encountered in the art at the time of the invention; and
3. the sophistication of the technology in the art at the time of the invention, including the rapidity with which innovations were made in the art at the time of the invention.

KSR Int'l Co. v. Teleflex Inc., 127 S. Ct. 1727, 1742-43 (2007); *Graham v. John Deere Co.*, 383 U.S. 1, 17-18 (1966); *Ruiz v. A.B. Chance Co.*, 234 F.3d 654, 666-67 (Fed. Cir. 2000); *Envtl Designs, Ltd. v. Union Oil Co.*, 713 F.2d 693, 696-97 (Fed. Cir. 1983).

7.4 The Fourth Factor: Other Considerations

Before deciding the issue of obviousness, you must also consider certain factors, which may help to determine whether or not the invention would have been obvious. No factor alone is dispositive, and you must consider the obviousness or nonobviousness of the invention as a whole.

Practice Note: Careful consideration should be given to the Court's role in determining the admissibility of evidence of secondary considerations. In addition, the materiality of the evidence depends on the existence of a nexus between the consideration and the invention as opposed to other factors. Only if the Court determines that there is a sufficient nexus that a consideration is admissible should the jury be instructed on it.

[PROVIDE ONLY THOSE INSTRUCTIONS THAT ARE APPROPRIATE.]

1. Were products covered by the claim commercially successful due to the merits of the claimed invention rather than due to advertising, promotion, salesmanship, or features of the product other than those found in the claim?
2. Was there long felt need for a solution to the problem facing the inventors, which was satisfied by the claimed invention?
3. Did others try, but fail, to solve the problem solved by the claimed invention?
4. Did others copy the claimed invention?
5. Did the claimed invention achieve unexpectedly superior results over the closest prior art?
6. Did others in the field, or [the Defendant] praise the claimed invention or express surprise at the making of the claimed invention?
7. Did others accept licenses under [abbreviated patent number] patent because of the merits of the claimed invention?

Answering all, or some, of these questions “yes” may suggest that the claim was not obvious. Answering all, or some, of these questions “no” may suggest that the claims would have been obvious. These factors are relevant only if there is a connection, or nexus, between the factor and the invention covered by the patent claims. Even if you conclude that some of the above indicators have been established, those factors should be considered along with all the other evidence in the case in determining whether [the defendant] has proven that the claimed invention would have been obvious.

Graham v. John Deere Co., 383 U.S. 1, 17-18 (1966); *United States v. Adams*, 383 U.S. 39, 52 (1966); *Perkin-Elmer Corp. v. Computervision Corp.*, 732 F.2d 888, 894-95 (Fed. Cir. 1984); *Envtl. Designs, Ltd. v. Union Oil Co.*, 713 F.2d 693, 697 (Fed. Cir. 1983); *WL Gore & Assocs., Inc. v. Garlock, Inc.*, 721 F.2d 1540, 1555-56 (Fed. Cir. 1983); *Stratoflex, Inc., v. Aeroquip Corp.*, 713 F.2d 1530, 1538-39 (Fed. Cir. 1983).

8. Enablement

Practice Note: Enablement is a question of law for the Court. The jury should be instructed on subsidiary fact issues only if, and only to the extent, that there is a specific issue of fact that the jury must decide that bears on the issue of enablement. If not, this instruction should not be given.

[The defendant] contends that claim[s] _____ of the [abbreviated patent number] patent [is] [are] invalid for lack of enablement. [The defendant] bears the burden of establishing lack of enablement by the highly probable standard.

A patent must disclose sufficient information to enable or teach persons of ordinary skill in the field of the invention, at the time the [priority] patent application was filed, to make and use the full scope of the claimed invention without undue experimentation. This requirement is known as the enablement requirement. If a patent claim is not enabled, it is invalid.

In considering whether a patent complies with the enablement requirement, you must keep in mind that patents are written for persons of ordinary skill in the field of the invention. Thus, a patent need not expressly state information that persons of ordinary skill would be likely to know or could obtain.

The fact that some experimentation may be required for a person of ordinary skill to practice the claimed invention does not mean that a patent does not meet the enablement requirement. Factors that you may consider in determining whether persons of ordinary skill in the field of the invention would require undue experimentation to make and use the full scope of the claimed invention include:

1. the quantity of experimentation necessary and whether that experimentation involves only known or commonly used techniques. [The question of undue experimentation is a matter of degree. Even extensive experimentation does not necessarily make the experiments unduly extensive where the experiments are routine, such as repetition of known or commonly used techniques. But permissible experimentation is not without bounds.⁴⁰
2. the amount of direction or guidance disclosed in the patent;
3. the presence or absence of working examples in the patent;
4. the nature of the invention;
5. the state of the prior art;
6. the relative skill of those in the art;

40. *Cephalon, Inc. v. Watson Pharm., Inc.*, 707 F.3d 1330, 1338 (Fed. Cir. 2013); *see also Johns Hopkins Univ. v. CellPro, Inc.*, 152 F.3d 1342, 1360-61 (Fed. Cir. 1998).]

7. the predictability of the art; and
8. the breadth of the claims.

Practice Note: This Instruction should be modified to identify the fact issues the jury is being asked to determine. The ultimate issue of enablement is a question of law to be decided by the Court.

35 U.S.C. § 112; *Streck, Inc. v. Research & Diagnostic Sys.*, 665 F.3d 1269, 1288-89 (Fed. Cir. 2012); *Transocean Offshore Deepwater Drilling, Inc. v. Maersk Contractors USA, Inc.*, 617 F.3d 1296, 1305-07 (Fed. Cir. 2010); *ALZA Corp. v. Andrx Pharms., LLC*, 603 F.3d 935, 939-43 (Fed. Cir. 2010); *Martek Biosciences Corp. v. Nutrinova, Inc.*, 579 F.3d 1363, 1377-79 (Fed. Cir. 2009); *Sitrick v. Dreamworks, LLC*, 516 F.3d 993, 999-1002 (Fed. Cir. 2008); *Liebel-Flarsheim Co. v. Medrad, Inc.*, 481 F.3d 1371, 1380 (Fed. Cir. 2007); *AK Steel Corp. v. Sollac & Ugine*, 344 F.3d 1234, 1244 (Fed. Cir. 2003); *Durel Corp. v. Osram Sylvania Inc.*, 256 F.3d 1298, 1306 (Fed. Cir. 2001); *Union Pac. Resources Co. v. Chesapeake Energy Corp.*, 236 F.3d 684, 690-92 (Fed. Cir. 2001); *Ajinomoto Co. v. Archer-Daniels-Midland Co.*, 228 F.3d 1338, 1345-46 (Fed. Cir. 2000); *Nat'l Recovery Techs., Inc. v. Magnetic Separation Sys., Inc.*, 166 F.3d 1190, 1195-98 (Fed. Cir. 1999); *Enzo Biochem, Inc. v. Calgene, Inc.*, 188 F.3d 1362, 1371 (Fed. Cir. 1999); *In re Wands*, 858 F.2d 731, 737 (Fed. Cir. 1988); *Amgen, Inc. v. Chugai Pharm. Co.*, 927 F.2d 1200, 1213 (Fed. Cir. 1991).

9. Written Description Requirement

Practice Note: Written description is a question of fact for the finder of fact. The jury should be instructed on these issues only if, and only to the extent, that specific claims are challenged for lack of written description support and there is sufficient evidentiary support for these arguments.

The [Defendant] contends that claim[s] ____ of the [abbreviated patent number] patent [is] [are] invalid for failure to satisfy the written description requirement. [The defendant] bears the burden of establishing lack of written description by clear and convincing evidence.

A patent must contain a written description of the [product or process] claimed in the patent. The written description requirement helps to ensure that the patent applicant actually invented the claimed subject matter. To satisfy the written description requirement, the patent specification must describe each and every limitation of a patent claim, in sufficient detail, although the exact words found in the claim need not be used. When determining whether the specification discloses the invention, the claim must be viewed as a whole,.

The written description requirement is satisfied if persons of ordinary skill in the field of the invention would recognize, from reading the patent specification, that the inventor possessed the subject matter finally claimed in the patent. The written description requirement is satisfied if the specification shows that the inventor possessed his or her invention as of the date the [priority] patent application was filed, even though the claims themselves may have been changed or new claims added since that time.

It is unnecessary to spell out every detail of the invention in the specification, and specific examples are not required; only enough must be included in the specification to convince persons of ordinary skill in the art that the inventor possessed the full scope of the invention. In evaluating whether the specification has provided an adequate written description, you may take into account such factors as:

1. the nature and scope of the patent claims;
2. the complexity, predictability, and maturity of the technology at issue;
3. the existing knowledge in the relevant field; and
4. the scope and content of the prior art.

The issue of written description is decided on a claim-by-claim basis, not as to the entire patent or groups of claims.

If you find that [the defendant] has proven by clear and convincing evidence that the [abbreviated patent number] patent does not contain a written description for the invention[s] of claims _____, then you must find that the claim[s] [is] [are] invalid.

35 U.S.C. § 112; *Bard Peripheral Vascular, Inc. v. W.L. Gore & Assocs.*, 670 F.3d 1171, 1188-89 (Fed. Cir. 2012), *aff'd on reh'g*, 682 F.3d 1003, 1005 (Fed. Cir. 2012); *Streck, Inc. v. Research & Diagnostic Sys.*, 665 F.3d 1269, 1284-87 (Fed. Cir. 2012); *Atl. Research Mktg. Sys. v. Troy*, 659 F.3d 1345, 1353-55 (Fed. Cir. 2011); *Boston Sci. Corp. v. Johnson & Johnson*, 647 F.3d 1353, 1361-63 (Fed. Cir. 2011); *Crown Packaging Tech. v. Ball Metal Bev. Container Corp.*, 635 F.3d 1373, 1379-80 (Fed. Cir. 2011); *Centocor Ortho Biotech, Inc. v. Abbott Labs.*, 636 F.3d 1341, 1347-48 (Fed. Cir. 2011); *Ariad Pharms., Inc. v. Mass. Instit. of Tech.*, 598 F.3d 1336, 1351-52 (Fed. Cir. 2010) (en banc); *Research Corp. Techs., Inc. v. Microsoft Corp.*, 627 F.3d 859, 870 (Fed. Cir. 2010); *Laryngeal Mask Co. v. Ambu A/S*, 618 F.3d 1367, 1373-74 (Fed. Cir. 2010); *Revolution Eyewear, Inc. v. Aspex Eyewear, Inc.*, 563 F.3d 1358, 1366 (Fed. Cir. 2009); *PowerOasis, Inc. v. T-Mobile USA, Inc.*, 522 F.3d 1299, 1306 (Fed. Cir. 2008); *Falko-Gunter Faulkner v. Inglis*, 448 F.3d 1357, 1366 (Fed. Cir. 2006); *Kao Corp. v. Unilever U.S., Inc.*, 441 F.3d 963, 968 (Fed. Cir. 2006); *Monsanto Co. v. Scruggs*, 459 F.3d 1328, 1336 (Fed. Cir. 2006); *Univ. of Rochester v. G.D. Searle & Co., Inc.*, 358 F.3d 916, 922-28 (Fed. Cir. 2004); *Enzo Biochem, Inc. v. Gen-Probe Inc.*, 323 F.3d 956, 964 (Fed. Cir. 2002).

10. Unenforceability (Inequitable Conduct)

Practice Note: Inequitable conduct is an equitable issue that is decided by the Court, in its discretion.⁴¹ There is no right to a jury trial on inequitable conduct. Although the issue is sometimes submitted to the finder of fact for an Advisory Verdict, the issue must be decided by the Court, either with or without an Advisory Verdict. If the court elects to request an Advisory Verdict, the Court should consider whether to charge the jury on the entire issue, or solely on the materiality and/or intent to deceive issues. The verdict form should include separate questions on each of the issues on which the jury is charged, *i.e.*, materiality, intent, and/or balancing the equities.

The Court should consider carefully whether to request an Advisory Verdict. The issues are complex and potentially confusing. A clear-and-convincing-evidence standard applies to the inequitable conduct defense while the preponderance-of-the-evidence standard applies to the issue of whether the Patent and Trademark Office would have issued the patent “but for” the failure to disclose.⁴² In addition, the USPTO employs a “broadest reasonable interpretation” standard for claim construction, which may conflict with the Court’s construction of the claims. Submitting the issue for an Advisory Verdict increases the complexity of the Instructions, has the potential to confuse the jury, and may bias the jury’s consideration of other issues that it is required to decide. Federal Circuit authority establishes an objective threshold issue of whether the reference or conduct would have been a basis to deny patentability.⁴³ If this threshold issue is not satisfied, submitting the issue for an Advisory Verdict is not appropriate.

If an Advisory Verdict is requested, care must be taken to ensure that the issue(s) is properly raised and that there is sufficient evidence to support the defense.

41. *Flex-Rest, LLC v. Steelcase, Inc.*, 455 F.3d 1351, 1357 (Fed. Cir. 2006).

42. *Therasense, Inc. v. Becton Dickinson & Co.*, 649 F.3d 1276 (Fed. Cir. 2011) (*en banc*).

43. *Id.*

10.0 Inequitable Conduct – Generally

[The Defendant] contends that [the Plaintiff] may not enforce the [abbreviated patent number] patent against [the Defendant] because individuals substantively involved in the prosecution of the [abbreviated patent number] patent engaged in inequitable conduct before the Patent and Trademark Office during prosecution of that patent.

Applicants for a patent have a duty to prosecute patent applications in the Patent and Trademark Office with candor and good faith. This duty of candor and good faith extends to all inventors named on a patent application, all patent attorneys and patent agents involved in preparing and prosecuting the application, and every other individual involved in a substantial way with the prosecution of the patent application. An intentional failure to meet this duty of candor and good faith is referred to as “inequitable conduct.”

[In this case, [the Defendant] asserts that [DESCRIBE BRIEFLY EACH BASIS FOR [THE DEFENDANT]’S UNENFORCEABILITY DEFENSE].]

[The Defendant] must prove inequitable conduct by clear and convincing evidence. To determine whether the [abbreviated patent number] patent was obtained through inequitable conduct, you must determine:

1. whether an individual or individuals having this duty of candor and good faith [engaged in affirmative acts of egregious misconduct or] withheld or misrepresented information, or submitted false information, that was material to the examination of the patent application; and
2. that this individual or individuals acted with the specific intent to deceive or mislead the Patent and Trademark Office.

Therasense, Inc. v. Becton Dickinson & Co., 649 F.3d 1276 (Fed. Cir. 2011) (*en banc*); *Avid Identification Sys., Inc. v. Crystal Import Corp.*, 603 F.3d 967, 973-74 (Fed. Cir. 2010); *eSpeed, Inc. v. BrokerTec USA, L.L.C.*, 480 F.3d 1129, 1135 (Fed. Cir. 2007); *Digital Control, Inc. v. Charles Mach. Works*, 437 F.3d 1309, 1313 (Fed. Cir. 2006); *Purdue Pharma L.P. v. Endo Pharm., Inc.*, 438 F.3d 1123, 1128 (Fed. Cir. 2006); *Bristol-Myers Squibb Co. v. Rhone-Poulenc Rorer, Inc.*, 326 F.3d 1226, 1233 (Fed. Cir. 2003).

10.1 Materiality (Non-disclosure cases only)

[Defendant] contends that _____ was information [known to] [misrepresented by] an individual having the duty of good faith and candor to the Patent and Trademark Office, and that such information was [withheld from] [misrepresented to] the Patent and Trademark Office during the prosecution of the [abbreviated patent number] patent. If you find that an individual having this duty of good faith and candor [withheld] [misrepresented] information when applying for the [abbreviated patent number] patent, you must also determine whether that information was material information.

Information is material if “but for” the individual’s [failure to disclose] [misrepresentation of] the information during the prosecution, the Patent and Trademark Office would not have allowed one or more claims of the [abbreviated patent number] patent. In other words, information is material if it is more likely than not that the Patent and Trademark Office would not have allowed one or more claims of the [abbreviated patent number] patent if it had been aware of the [withheld] [true] information. To decide whether the Patent and Trademark Office would not have allowed one or more claims if it had been aware of the [withheld] [true] information, you should use the broadest reasonable interpretation of the claim or claims under consideration and apply the “more likely than not” standard, as the Patent and Trademark Office would have done.

If you decide that the Patent and Trademark Office would not have allowed one or more claims applying this standard, then the individual’s [failure to disclose] [misrepresentation of] the information during the prosecution is material, whether or not you also find the claims invalid under the standards for finding claims invalid in this lawsuit. This does not change the [Defendant]’s overall burden, however, to prove its inequitable conduct defense by the highly probable standard of proof.

Therasense, Inc. v. Becton Dickinson & Co., 649 F.3d 1276 (Fed. Cir. 2011) (*en banc*).

10.2 Materiality (Affirmative Egregious Misconduct cases only)

In this case, [the Defendant] alleges that [individual(s) accused of inequitable conduct] engaged in affirmative acts of egregious misconduct during the prosecution of the [abbreviated patent number] patent. Specifically, [the Defendant] alleges [summarize alleged affirmative acts of egregious misconduct]. If you are left with a clear conviction that [accused individual(s)] engaged in the conduct as alleged by [the Defendant], and that the conduct rises to the level of affirmative egregious misconduct, then you must find that the misconduct was material.

To assist you in your deliberation, examples of affirmative acts of egregious conduct would be perjury, including filing an unmistakably false affidavit in the Patent and Trademark Office during prosecution of the [abbreviated patent number], or fabricating evidence presented to the Patent and Trademark Office during prosecution of the [abbreviated patent number]. Affirmative acts of egregious conduct may also include deliberately planned and executed schemes to defraud the Patent and Trademark Office.

On the other hand, examples of things that do not rise to the level of affirmative acts of egregious conduct would be mere nondisclosure of prior art references to the Patent and Trademark Office, failure to submit references that are duplicative or cumulative of references of which the Patent and Trademark Office was already aware, or failure to mention prior art references in an affidavit during prosecution of the [abbreviated patent number].

Therasense, Inc. v. Becton Dickinson & Co., 649 F.3d 1276 (Fed. Cir. 2011) (*en banc*).

10.3 Intent to Deceive or Mislead

If you find by clear and convincing evidence that material information was withheld from or misrepresented to the Patent and Trademark Office, or that [accused individual(s)] engaged in affirmative egregious misconduct, you must next determine whether this was done with a specific intent to deceive or mislead the Patent and Trademark Office. You may find intent to deceive or mislead the Patent and Trademark Office from direct evidence. You may also infer intent to deceive or mislead the Patent and Trademark Office from the facts and surrounding circumstances. Whether based on direct or circumstantial evidence, the evidence must leave you with a clear conviction that material information was withheld from or misrepresented to the Patent and Trademark Office in order for you to find an intent to deceive or mislead.

For example, when a patentee has knowingly misrepresented a material fact or submitted false material information, and when the natural consequence of those intentional acts would be to deceive or mislead the Patent and Trademark Office, an inference that [the accused individual(s)] intended to deceive the Patent and Trademark Office may be appropriate.

When the individual having a duty of good faith and candor has deliberately withheld or misrepresented known material information from the Patent and Trademark Office, you may find that he or she acted with intent to deceive or mislead the Patent and Trademark Office if and only if that is the single most reasonable inference to be drawn from the evidence. If there are multiple reasonable inferences that may be drawn, you cannot find an intent to deceive or mislead. You may not infer that the individual acted with intent to deceive or mislead based solely on the fact or facts that the information withheld was material, or even highly material, or that the individual has not provided a good faith explanation for the withholding. Nor may you infer intent solely on the basis of gross negligence or negligence in withholding material information.

For example, it is not enough that the individual knew of a reference, should have known of its materiality, and did not submit it to the Patent and Trademark Office. Instead, you need to determine whether or not the individual knew of the withheld or misrepresented information, knew the information was material, and made a deliberate and conscious decision to withhold or misrepresent the information. In determining whether there was an intent to deceive or mislead the Patent and Trademark Office, you should consider the totality of the circumstances, including the nature of the conduct and whether that conduct occurred in good faith.

Therasense, Inc. v. Becton Dickinson & Co., 649 F.3d 1276 (Fed. Cir. 2011)(*en banc*); *Intellect Wireless, Inc. v. HTC Corp.*, 732 F.3d 1339, 1345 (Fed. Cir. 2013); *Larson Mfg. Co. of S.D. v. Aluminart Prods. Ltd.*, 559 F.3d 1317, 1340-41 (Fed. Cir. 2009); *Star Scientific, Inc. v. R.J. Reynolds Tobacco Co.*, 537 F.3d 1357, 1366, 1368

(Fed. Cir. 2008); *eSpeed, Inc. v. BrokerTec USA, L.L.C.*, 480 F.3d 1129, 1137-38 (Fed. Cir. 2007); *Purdue Pharma L.P. v. Endo Pharm. Inc.*, 438 F.3d 1123, 1133-34 (Fed. Cir. 2006); *PerSeptive Biosystems, Inc. v. Pharmacia Biotech, Inc.*, 225 F.3d 1315, 1319-20 (Fed. Cir. 2000); *Molins PLC v. Textron, Inc.*, 48 F.3d 1172, 1180-82 (Fed. Cir. 1995).

11. Damages

11.0 Damages – Generally

If you find that the accused [[device] [method]] infringes any of the claims of the [abbreviated patent number] patent, and that those claims are not invalid, you must determine the amount of damages to be awarded [the Plaintiff] for the infringement. On the other hand, if you find that each of the asserted patent claims is either invalid or is not infringed, then you need not consider damages in your deliberations.

[The Plaintiff] must prove each element of its damages—including the amount of the damages—by a preponderance of the evidence, which means more likely true than not.

If proven by the Plaintiff, damages must be in an amount adequate to compensate [the Plaintiff] for the infringement. The purpose of a damage award is to put [the Plaintiff] in about the same financial position it would have been in if the infringement had not happened. But, the damage award cannot be less than a reasonable royalty. You may not add anything to the amount of damages to punish an accused infringer or to set an example. You also may not add anything to the amount of damages for interest.

The fact that I am instructing you on damages does not mean that the Court believes that one party or the other should win in this case. My instructions about damages are for your guidance only in the event you find in favor of [the Plaintiff]. You will need to decide the issue of damages only if you find that one or more of the asserted claims are both not invalid and infringed.

Powell v. Home Depot U.S.A., Inc., 663 F.3d 1221, 1238 (Fed. Cir. 2011); *ResQNet.com, Inc. v. Lansa, Inc.*, 594 F.3d 860, 868 (Fed. Cir. 2010); *Lucent Techs., Inc. v. Gateway, Inc.*, 580 F.3d 1301, 1325 (Fed. Cir. 2009); 35 U.S.C. § 284 (2004); *Aro Mfg. Co. v. Convertible Top Replacement Co.*, 377 U.S. 476, 507 (1964); *Dow Chem. Co. v. Mee Indus., Inc.*, 341 F.3d 1370, 1381-82 (Fed. Cir. 2003); *Vulcan Eng'g Co. v. FATA Aluminum, Inc.*, 278 F.3d 1366, 1376 (Fed. Cir. 2002); *Grain Processing Corp. v. Am. Maize-Prods. Co.*, 185 F.3d 1341, 1349 (Fed. Cir. 1999); *Maxwell v. J. Baker, Inc.*, 86 F.3d 1098, 1108-09 (Fed. Cir. 1996); *Hebert v. Lisle Corp.*, 99 F.3d 1109, 1119 (Fed. Cir. 1996); *Rite-Hite Corp. v. Kelley Co.*, 56 F.3d 1538, 1544-45 (Fed. Cir. 1995); *Wang Labs., Inc. v. Toshiba Corp.*, 993 F.2d 858, 870 (Fed. Cir. 1993); *Fromson v. W. Litho Plate & Supply Co.*, 853 F.2d 1568, 1574 (Fed. Cir. 1988), *overruled on other grounds by Knorr-Bremse Systeme Fuer Nutzfahrzeuge v. Dana Corp.*, 383 F.3d 1337, 1342 (Fed. Cir. 2004); *Del Mar Avionics, Inc. v. Quinton Instrument Co.*, 836 F.2d 1320, 1326 (Fed. Cir. 1987).

11.1 Date Damages Begin

11.1.1 Alternate A – When the Date of the Notice of Infringement is Stipulated

The date that [the Plaintiff] first notified [the Defendant] of its claim of patent infringement is the date for the start of damages calculations. The parties agree that date is [infringement notice date].

11.1.2 Alternate B – When the Date of the Notice of Infringement is Disputed – Product Claims

The date that [the Plaintiff] first notified [the Defendant] of its claim for patent infringement is the date for the start of damages. The parties do not agree on that date, and it is up to you to determine what that date is. [The Plaintiff] must prove that it is more likely than not that the [Defendant] actually was notified of the claim for patent infringement as of the date alleged by [the Plaintiff].

[The Plaintiff] can give notice in two ways. The first way is to give notice to the public in general. [The Plaintiff] can do this by marking substantially all of the products that it sold which included the patented invention, or including on the labeling of substantially all of the products, the word “patent” or the abbreviation “PAT” with the number of the patent. [The Plaintiff] also may give notice by marking substantially all of the products with “Patent” or “Pat” and a free internet address where there is a posting that connects the product with the patent number. [Licensees of the [abbreviated patent number] patent who use the patented invention must also mark substantially all of their products that include the patented invention with the patent number.] This type of notice starts from the date [the Plaintiff] [and its licensees] began to mark substantially all of its products that use the patented invention with the patent number. If [the Plaintiff] [and its licensees] did not mark substantially all of those products with the patent number, then [the Plaintiff] did not provide notice in this way.⁴⁴

A second way [the Plaintiff] can give notice of its patent[s] is to notify [the Defendant] directly with a specific claim that the [allegedly infringing product] infringed the [abbreviated patent number] patent. This type of notice starts from the date [Defendant] received the notice. If you find that [the Plaintiff], before filing this lawsuit, did not properly mark its products and did not notify [the Defendant] with a specific charge that the [allegedly infringing product] infringed, then [the Plaintiff] can only recover damages for infringement that occurred after it sued [the Defendant] on [lawsuit filing date].

44. If there is an issue of fact regarding the adequacy of [the Patentee’s marking], additional instructions will be required.

11.1.3 Alternate C – When the Date Damages Begin is the Date the Lawsuit was Filed

The date that damages begin to be calculated in this case is the date this lawsuit was filed, which is [the lawsuit filing date].

35 U.S.C. § 287(a); *Funai Elec. Co., Ltd. v. Daewoo Electronics Corp.*, 616 F.3d 1357, 1373-74 (Fed. Cir. 2010); *Gart v. Logitech, Inc.*, 254 F.3d 1334, 1345 (Fed. Cir. 2001); *Lans v. Digital Equip. Corp.*, 252 F.3d 1320, 1327-28 (Fed. Cir. 2001); *Crystal Semiconductor Corp. v. TriTech Microelects. Int'l, Inc.*, 246 F.3d 1336, 1353 (Fed. Cir. 2001); *Amsted Indus., Inc. v. Buckeye Steel Castings Co.*, 24 F.3d 178, 184-87 (Fed. Cir. 1994); *Devices for Med., Inc. v. Boehl*, 822 F.2d 1062, 1066 (Fed. Cir. 1987).

11.2 Damages – Types of Damages That May be Recovered

Practice Note: The issue of damages is rapidly evolving at both the Federal Circuit and Supreme Court. The courts have recently supported vigorous examination of the plaintiff's damages theory before submitting this issue to the jury. Only if the plaintiff's damages theory is admissible and supported by sufficient evidence should it be submitted to the jury. In addition, in order to avoid undue burden and jury confusion, the jury should be instructed on only those theories of recovery that the Court has determined are admissible.

There are several types of damages that are available for patent infringement.

One type of patent damages is lost profits. Lost profits are the additional profits that the patent owner would have made if the defendant had not infringed. In this connection, you may hear references to the “but for” test—which means, “what profits would the patent owner have made ‘but for’ the alleged infringement?”

A second type of patent damages is price suppression. The patentee may have been forced to reduce its price for the patented product or other related products in order to compete with the infringer. Again, the patentee must prove to you by a preponderance of the evidence what price concessions it was forced to give that are due to the infringement as opposed to other factors.

A third measure of damages is convoyed sales. A patentee may have lost sales of other related products other than the patented product, if these products are typically sold together.

Finally, another measure of damages is a reasonable royalty. A reasonable royalty is the reasonable amount that someone wanting to use the patented invention would have agreed to pay to the patent owner and the patent owner would have ac-

cepted. A reasonable royalty is the minimum amount of damages that a patent owner can receive for an infringement.

11.3 Lost Profits – “But-For” Test

[The Plaintiff] is seeking lost profits damages in this case. To prove lost profits, [the Plaintiff] must show that, but for [the Defendant]’s infringement, [the Plaintiff] would have made additional profits through the sale of all or a portion of the sales of [the allegedly infringing products] made by [the Defendant]. Plaintiff must prove this by a preponderance of the evidence, more likely than not. Part of your job is to determine what the customers who purchased the [allegedly infringing product] [from the Defendant] would have done if the alleged infringement had not occurred. It is important to remember that the profits I have been referring to are the profits allegedly lost by [the Plaintiff], not the profits, if any, made by [the Defendant] on the allegedly infringing sales.

Siemens Med. Solutions USA, Inc. v. Saint-Gobain Ceramics & Plastics, Inc., 637 F.3d 1269, 1289 (Fed. Cir. 2011); *American Seating Co. v. USSC Grp., Inc.*, 514 F.3d 1262 (Fed. Cir. 2008); *Aro Mfg. Co. v. Convertible Top Replacement Co.*, 377 U.S. 476, 507 (1964); *Micro Chem. v. Lextron, Inc.*, 318 F.3d 1119, 1122-25 (Fed. Cir. 2003); *Ferguson Beauregard/Logic Controls v. Mega Sys., L.L.C.*, 350 F.3d 1327, 1345-46 (Fed. Cir. 2003); *Ericsson, Inc. v. Harris Corp.*, 352 F.3d 1369, 1377 (Fed. Cir. 2003); *Tate Access Floors, Inc. v. Maxcess Techs., Inc.*, 222 F.3d 958, 971 (Fed. Cir. 2000); *Grain Processing Corp. v. Am. Maize-Prods. Co.*, 185 F.3d 1341, 1349 (Fed. Cir. 1999); *King Instruments Corp. v. Perego*, 65 F.3d 941, 952 (Fed. Cir. 1995); *State Indus., Inc. v. Mor-Flo Indus., Inc.*, 883 F.2d 1573, 1577 (Fed. Cir. 1989); *Ryco, Inc. v. Ag-Bag Corp.*, 857 F.2d 1418, 1428 (Fed. Cir. 1988); *King Instrument Corp. v. Otari Corp.*, 767 F.2d 853, 863-64 (Fed. Cir. 1985); *Paper Converting Mach. Co. v. Magna-Graphics Corp.*, 745 F.2d 11, 21 (Fed. Cir. 1984); *Am. Hoist & Derrick Co. v. Sowa & Sons, Inc.*, 725 F.2d 1350, 1365 (Fed. Cir. 1984); *Central Soya Co. v. Geo A Hormel & Co.*, 723 F.2d 1573, 1578-79 (Fed. Cir. 1983).

11.4 Lost Profits – Panduit Factors

[The Plaintiff] has proven its lost profits if you find that [the Plaintiff] has proven each of the following factors by the more likely than not standard:

1. the demand for the patented [[product] [method]],
2. absence of acceptable non-infringing substitutes,
3. that [the Plaintiff] had the manufacturing and marketing ability to make all or a part of the infringing sales actually made by [the Defendant], and
4. the amount of profit that [the Plaintiff] would have made if it were not for [the Defendant]’s infringement.

I will now explain each of these factors.

Siemens Med. Solutions USA, Inc. v. Saint-Gobain Ceramics & Plastics, Inc., 637 F.3d 1269, 1287 (Fed. Cir. 2011); *DePuy Spine, Inc. v. Medtronic Sofamor Danek, Inc.*, 567 F.3d 1314, 1329 (Fed. Cir. 2009); *Tate Access Floors, Inc. v. Maxcess Techs., Inc.*, 222 F.3d 958, 971 (Fed. Cir. 2000); *Gargoyles, Inc. v. United States*, 113 F.3d 1572, 1577-79 (Fed. Cir. 1997); *Stryker Corp. v. Intermedics Orthopedics, Inc.*, 96 F.3d 1409, 1417-18 (Fed. Cir. 1996); *Rite-Hite Corp. v. Kelley Co.*, 56 F.3d 1538, 1545 (Fed. Cir. 1995); *State Indus., Inc. v. Mor-Flo Indus., Inc.*, 883 F.2d 1573, 1577 (Fed. Cir. 1989); *Yarway Corp. v. Eur-Control USA, Inc.*, 775 F.2d 268, 275 (Fed. Cir. 1985); *Panduit Corp. v. Stahlin Bros. Fibre Works, Inc.*, 575 F.2d 1152, 1156 (6th Cir. 1978).

11.5 Lost Profits – Panduit Factors – Demand

The first factor asks whether there was demand for the patented product in the relevant market. [The Plaintiff] can prove demand for the patented product by showing significant sales of [the Plaintiff]’s own patented product. [The Plaintiff] also can prove demand for the patented product by showing significant sales of [the Defendant]’s products that are covered by the patent in suit. To use sales of [the Defendant]’s products as proof of this demand, however, [the Plaintiff]’s and [the Defendant]’s product must be sufficiently similar to compete against each other in the same market or market segment. You also should not consider sales of products mainly due to advertising and marketing, and unpatented features of the products as evidence of demand for the patented product.

DePuy Spine, Inc. v. Medtronic Sofamor Danek, Inc., 567 F.3d 1314, 1330 (Fed. Cir. 2009); *Rite-Hite Corp. v. Kelley Co.*, 56 F.3d 1538, 1548-49 (Fed. Cir. 1995); *BIC Leisure Prods., Inc. v. Windsurfing Int’l, Inc.*, 1 F.3d 1214, 1218-19 (Fed. Cir. 1993); *SmithKline Diagnostics, Inc. v. Helena Labs. Corp.*, 926 F.2d 1161, 1165 n.3 (Fed. Cir. 1991); *Gyromat Corp. v. Champion Spark Plug Co.*, 735 F.2d 549, 552 (Fed. Cir. 1984).

11.6 Lost Profits – Panduit Factors – Acceptable Non-Infringing Substitutes

The second factor asks whether there were non-infringing, acceptable substitutes for the patented products in the market place and the impact of such substitute products on the marketplace absent the sale of [Defendant]’s products. If the realities of the marketplace are that competitors other than [the Plaintiff] would likely have captured some or all of the sales made by the [Defendant], even despite a difference in the products, then [the Plaintiff] is not entitled to lost profits on those sales.

To be an acceptable substitute, the products must have had one or more of the advantages of the patented invention that were important to the actual buyers of the infringing products, not the public in general. The acceptable substitutes also must not infringe the patent because they were licensed under the patent or they did not include all the features required by the patent. The acceptable substitutes, in ad-

dition, must have been available during the damages period. An acceptable non-infringing substitute is available if, during the damages period, a competitor or [the Defendant] had all the necessary equipment, materials, know-how, and experience to design and manufacture the substitute and sell such substitute instead of its infringing sales at the time those infringing sales were made. If you determine that some of [the Defendant]’s customers would just as likely have purchased a non-infringing acceptable product, then [the Plaintiff] has not shown it lost those sales but for [the Defendant]’s sales.

Even if you find that [the Plaintiff]’s and [the Defendant]’s products were the only ones with the advantages of the patented invention, [the Plaintiff] is nonetheless required to prove to you that it in fact would have made the [the Defendant]’s infringing sales.

SynQor, Inc. v. Aresyn Techs., Inc., 709 F.3d 1365, 1383 (Fed. Cir. 2013); *DePuy Spine, Inc. v. Medtronic Sofamor Danek, Inc.*, 567 F.3d 1314, 1331-32 (Fed. Cir. 2009); *American Seating Co. v. USSC Grp., Inc.*, 514 F.3d 1262, (Fed. Cir. 2008); *Mars, Inc. v. Coin Acceptors, Inc.*, 527 F.3d 1359, 1372-73 (Fed. Cir. 2008); *Grain Processing Corp. v. Am. Maize-Prods. Co.*, 185 F.3d 1341, 1349 (Fed. Cir. 1999); *Gargoyles, Inc. v. United States*, 113 F.3d 1572, 1577-78 (Fed. Cir. 1997); *Uniroyal, Inc. v. Rudkin-Wiley Corp.*, 939 F.2d 1540, 1545-46 (Fed. Cir. 1991); *Standard Havens Prods., Inc. v. Gencor Indus.*, 953 F.2d 1360, 1373 (Fed. Cir. 1991); *Kaufman Co. v. Lantech, Inc.*, 926 F.2d 1136, 1142-43, 1143 n.17 (Fed. Cir. 1991); *SmithKline Diagnostics, Inc. v. Helena Lab. Corp.*, 926 F.2d 1161, 1166 (Fed. Cir. 1991); *TWM Mfg. Co. v. Dura Corp.*, 789 F.2d 895, 901-02 (Fed. Cir. 1986).

11.7 Lost Profits – Market Share

If you find that there were other acceptable non-infringing substitute products in the market, then [the Plaintiff] may be entitled to lost profits on a portion of [the Defendant]’s infringing sales. The burden is on [the Plaintiff] to prove that it is more likely than not that the patented product competed in the same market as [the Defendant]’s infringing product, and that [the Plaintiff] would have made a portion of the infringing sales equal to at least [the Plaintiff]’s share of that market but for [the Defendant]’s infringement. It is not necessary for [the Plaintiff] to prove that [the Plaintiff] and [the Defendant] were the only two suppliers in the market for [the Plaintiff] to demonstrate entitlement to lost profits. The burden is on [the Plaintiff], however, to show that it is more likely than not that it would have sold that portion had [the Defendant]’s product never existed. In a two-supplier market, the burden is on [the Plaintiff] to show that its product competed in the same market with the [the Defendant]’s product and that it would have made those sales if the infringement had not occurred.

DePuy Spine, Inc. v. Medtronic Sofamor Danek, Inc., 567 F.3d 1314, 1330 (Fed. Cir. 2009); *Ericsson, Inc. v. Harris Corp.*, 352 F.3d 1369, 1377-78 (Fed. Cir. 2003); *Crystal Semiconductor Corp. v. Tritech Microelects. Int’l, Inc.*, 246 F.3d 1336, 1353-57 (Fed. Cir. 2001); *BIC Leisure Prods., Inc. v. Windsurfing Int’l, Inc.*, 1 F.3d 1214

(Fed. Cir. 1993); *State Indus., Inc. v. Mor-Flo Indus., Inc.*, 883 F.2d 1573, 1577-78 (Fed. Cir. 1989).

11.8 Lost Profits – Panduit Factors – Capacity

The third factor asks whether [the Plaintiff] had the manufacturing and marketing ability to actually make the sales it allegedly lost due to [the Defendant]’s infringement. [The Plaintiff] must prove that it could have supplied the additional patented products needed to make the sales [the Plaintiff] said it lost, or that someone working with [the Plaintiff] could have supplied the additional patented products. [The Plaintiff] also must prove that it more likely than not had the ability to market and sell these additional patented products.

Wechsler v. Macke Int’l Trade, Inc., 486 F.3d 1286, 1293 (Fed. Cir. 2007); *Gargoyles, Inc. v. United States*, 113 F.3d 1572, 1577-78 (Fed. Cir. 1997); *Fonar Corp. v. Gen. Elec. Co.*, 107 F.3d 1543, 1553 (Fed. Cir. 1997); *Kearns v. Chrysler Corp.*, 32 F.3d 1541, 1551 (Fed. Cir. 1994); *Datascope Corp. v. SMEC, Inc.*, 879 F.2d 820, 825 (Fed. Cir. 1989); *Gyromat Corp. v. Champion Spark Plug Co.*, 735 F.2d 549, 554 (Fed. Cir. 1984).

11.9 Lost Profits – Panduit Factors – Amount of Profit Incremental Income Approach

[The Plaintiff] may calculate the amount of its lost profits by calculating its lost sales for the patented product and subtracting from that amount any additional costs or expenses that [the Plaintiff] would have had to pay to make the lost sales. This might include additional costs for making the products, and additional sales costs, additional packaging costs, additional shipping costs, etc. Any costs that do not change when more products are made, such as taxes, insurance, rent and administrative overhead, should not be subtracted from the lost sales amount. The amount of lost profits cannot be speculative but it need not be proved with unerring certainty.

Sensonics, Inc. v. Aerosonic Corp., 81 F.3d 1566, 1572 (Fed. Cir. 1996); *Oiness v. Walgreen Co.*, 88 F.3d 1025, 1030 (Fed. Cir. 1996); *Beatrice Foods Co. v. New England Printing & Lithographing Co.*, 923 F.2d 1576, 1579 (Fed. Cir. 1991); *Kalman v. Berlyn Corp.*, 914 F.2d 1473, 1482-83 (Fed. Cir. 1990); *State Indus., Inc. v. Mor-Flo Indus., Inc.*, 883 F.2d 1573, 1579-80 (Fed. Cir. 1989); *Ryco, Inc. v. Ag-Bag Corp.*, 857 F.2d 1418, 1428 (Fed. Cir. 1988); *Del Mar Avionics, Inc. v. Quinton Instrument Co.*, 836 F.2d 1320, 1327 (Fed. Cir. 1987); *King Instrument Corp. v. Otari*, 767 F.2d 853, 863-64 (Fed. Cir. 1985); *Gyromat Corp. v. Champion Spark Plug Co.*, 735 F.2d 549, 554-55 (Fed. Cir. 1984); *Paper Converting Mach. Co. v. Magna-Graphics Corp.*, 745 F.2d 11, 22 (Fed. Cir. 1984); *Bio-Rad Labs., Inc. v. Nicolet Inst. Corp.*, 739 F.2d 604 (Fed. Cir. 1984); *Lam, Inc. v. Johns-Manville Corp.*, 718 F.2d 1056, 1065 (Fed. Cir. 1983).

11.10 Price Erosion

[The Plaintiff] is entitled to recover additional damages if it can show that it is more likely than not that, but for [the Defendant]’s infringement, [the Plaintiff] [[would have been able to charge higher prices] [would not have had to lower its prices]] for its patented products. If you find that [the Plaintiff] has met its burden of proof, then you may award as additional damages an amount equal to the difference between the profits that [the Plaintiff] would have made at the higher price and the profits [the Plaintiff] actually made selling its patented products at the lower price that [the Plaintiff] charged for its patented product. This type of damage is referred to as price erosion damages.

If you find that [the Plaintiff] suffered price erosion damages, then you also may use the higher price that [the Plaintiff] would have charged in determining [the Plaintiff]’s lost sales and lost profits due to [the Defendant]’s infringement. However, if you calculate price erosion or lost profits damages using the higher price for the patented product, then you also must take into account any decrease in [the Plaintiff]’s sales that might have occurred due to the higher price for the patent products. In order to award lost profits based on price erosion, it is not required that [the Plaintiff] knew that [the Defendant]’s competing product infringed the patent, if [the Plaintiff] reduced its price to meet [the Defendant]’s prices.

Power Integrations, Inc. v. Fairchild Semiconductor Int’l, Inc., 711 F.3d 1348, 1377-80 (Fed. Cir. 2013); *Siemens Med. Solutions USA, Inc. v. Saint-Gobain Ceramics & Plastics, Inc.*, 637 F.3d 1269, 1287 (Fed. Cir. 2011); *Ericsson, Inc. v. Harris Corp.*, 352 F.3d 1369, 1378-79 (Fed. Cir. 2003); *Vulcan Eng’g Co. v. FATA Aluminum, Inc.*, 278 F.3d 1366, 1377 (Fed. Cir. 2002); *Rite-Hite Corp. v. Kelley Co.*, 56 F.3d 1538, 1544 (Fed. Cir. 1995) (*en banc*) (applying test articulated in *Panduit Corp. v. Stahl Bros. Fibre Works, Inc.*, 575 F.2d 1152 (6th Cir. 1978)); *BIC Leisure, Inc. v. Windsurfing Int’l, Inc.*, 1 F.3d 1214, 1218 (Fed. Cir. 1993); *Minn. Mining & Mfg. Co. v. Johnson & Johnson Orthopaedics, Inc.*, 976 F.2d 1559, 1578-79 (Fed. Cir. 1992); *Amstar Corp. v. Envirotech Corp.*, 823 F.2d 1538, 1543 (Fed. Cir. 1987); *Lam, Inc. v. Johns-Manville Corp.*, 718 F.2d 1056, 1065 (Fed. Cir. 1983).

11.11 Cost Escalation

[The Plaintiff] can recover additional damages if it can show that it also lost profits because its costs—such as additional marketing costs—went up as a result of [the Defendant]’s infringement of [the Plaintiff]’s patent. [The Plaintiff] must prove that it was more likely than not that its costs went up because of [the Defendant]’s actions, and not for some other reason.

Amstar Corp. v. Envirotech Corp., 823 F.2d 1538, 1543 (Fed. Cir. 1987); *Lam, Inc. v. Johns-Manville Corp.*, 718 F.2d 1056, 1064-65 (Fed. Cir. 1983).

11.12 Convoyed Sales

In this case, [the Plaintiff] contends that the patented product is ordinarily sold along with other products, namely [collateral products]. These other products are called “collateral products.” It is part of your job to determine whether [the Plaintiff] has proved that it is entitled to damages for the lost sales of any collateral products.

To recover lost profits for lost sales of any collateral products, [the Plaintiff] must prove two things. First, [the Plaintiff] must prove that it is more likely than not that it would have sold the collateral products but for the infringement. Second, the collateral products and the patented product must be so closely related that they effectively act or are used together for a common purpose. Damages for lost collateral sales, if any, are calculated in the same way as for calculating lost profits on the patented product.

Aro Mfg. Co. v. Convertible Top Replacement Co., 377 U.S. 476, 507 (1964); *DePuy Spine, Inc. v. Medtronic Sofamor Danek, Inc.*, 567 F.3d 1314, 1333 (Fed. Cir. 2009); *Rite-Hite Corp. v. Kelley Co.*, 56 F.3d 1538, 1549-51 (Fed. Cir. 1995); *State Indus., Inc. v. Mor-Flo Indus., Inc.*, 883 F.2d 1573, 1580 (Fed. Cir. 1989); *Kori Corp. v. Wilco Marsh Buggies & Draglines, Inc.*, 761 F.2d 649, 656 (Fed. Cir. 1985); *Paper Converting Mach. Co. v. Magna-Graphics Corp.*, 745 F.2d 11, 22-23 (Fed. Cir. 1984).

11.13 Reasonable Royalty – Generally

If you find that [the Plaintiff] has not proven its claim for lost profits, or if you find that [the Plaintiff] has proven its claim for lost profits for only a portion of the infringing sales, then you must consider the issue of a reasonable royalty.

The patent law provides that the amount of damages that [the Defendant] should pay [the Plaintiff] for infringing [the Plaintiff]’s patent must be enough to compensate for the infringement, but may not be less than a reasonable royalty for the use of [the Plaintiff]’s invention.

You must award the [the Plaintiff] a reasonable royalty in the amount that the [the Plaintiff] has proved it could have earned on any infringing sales for which you have not already awarded lost profit damages. A royalty is a payment made to a patent owner by someone else in exchange for the rights to [make, use, sell, or import] a patented product.

The reasonable royalty award must be based on the incremental value that the patented invention adds to the end product. When the infringing products have both patented and unpatented features, measuring this value requires a determination of the value added by the patented features. The ultimate combination of royalty base and royalty rate must reflect the value attributable to the infringing features of the product, and no more.

35 U.S.C. § 284; *Ericsson, Inc. v. D-Link Sys., Inc.*, No. 10-CV-0473, 2014 U.S. App. LEXIS 22778 at *53, 54 (Fed. Cir. 2014); *VirnetX, Inc. v. Cisco Sys., Inc.*, 767 F.3d 1308, 1326 (Fed. Cir. 2014); *Apple Inc. et al v. Motorola Inc., et al.*, ___ F.3d ___ (Fed. Cir. Apr. 25, 2014); *Uniloc USA, Inc. v. Microsoft Corp.*, 632 F.3d 1292, 1312 (Fed. Cir. 2011); *Lucent Techs., Inc. v. Gateway, Inc.*, 580 F.3d 1301, 1324-25 (Fed. Cir. 2009); *Fromson v. W. Litho Plate & Supply Co.*, 853 F.2d 1568, 1574 (Fed. Cir. 1998) overruled on other grounds by *Knorr-Bremse Systeme Fuer Nutzfahrzeuge v. Dana Corp.*, 383 F.3d 1337, 1342 (Fed. Cir. 2004); *Minco, Inc. v. Combustion Eng'g, Inc.*, 95 F.3d 1109, 1119 (Fed. Cir. 1996); *Mahurkar v. C.R. Bard, Inc.*, 79 F.3d 1572, 1579 (Fed. Cir. 1996); *Rite-Hite Corp. v. Kelley Co.*, 56 F.3d 1538, 1554 (Fed. Cir. 1995) (*en banc*).

11.14 Reasonable Royalty Definition – Using the “Hypothetical Negotiation” Method

A reasonable royalty is the royalty that would have resulted from a hypothetical license negotiation between [the Plaintiff] and [the Defendant]. Of course, we know that they did not agree to a license and royalty payment. But, in order to decide on the amount of reasonable royalty damages, you should assume that the parties did negotiate a license just before the infringement began. This is why it is called a “hypothetical” license negotiation. You should assume that both parties to the hypothetical negotiation understood that the patent was valid and infringed and both were willing to enter into a license. You should also presume that the parties had full knowledge of the facts and circumstances surrounding the infringement at the time of the hypothetical negotiation.

Apple Inc. et al v. Motorola Inc., et al., ___ F.3d ___ (Fed. Cir. Apr. 25, 2014); *LaserDynamics, Inc. v. Quanta Computer, Inc. et al*, 694 F.3d 51, 75 (Fed. Cir. 2012); *Uniloc USA, Inc. v. Microsoft Corp.*, 632 F.3d 1292, 1311 (Fed. Cir. 2011); *Fujifilm Corp. v. Benun*, 605 F.3d 1366, 1372 (Fed. Cir. 2010); *Lucent Techs., Inc. v. Gateway, Inc.*, 580 F.3d 1301, 1324-25 (Fed. Cir. 2009); *Mahurkar v. C.R. Bard, Inc.*, 79 F.3d 1572, 1579 (Fed. Cir. 1996); *Maxwell v. J. Baker, Inc.*, 86 F.3d 1098, 1109-10 (Fed. Cir. 1996); *Rite-Hite Corp. v. Kelley Co.*, 56 F.3d 1538, 1554 (Fed. Cir. 1995) (*en banc*); *Wang Labs., Inc. v. Toshiba Corp.*, 993 F.2d 858, 870 (Fed. Cir. 1993).

11.15 Relevant Factors if Using the Hypothetical Negotiation Method

In determining the amount of a reasonable royalty, you may consider evidence on any of the following factors, in addition to any other evidence presented by the parties on the economic value of the patent:

1. Any royalties received by the licensor for the licensing of the patent-in-suit, proving or tending to prove an established royalty.
2. The rates paid by [the Defendant] to license other patents comparable to the [abbreviated patent number] patent.

Appendix E: Model Patent Jury Instructions

3. The nature and scope of the license, as exclusive or non-exclusive, or as restricted or non-restricted in terms of its territory or with respect to whom the manufactured product may be sold.
4. The licensor's established policy and marketing program to maintain its right to exclude others from using the patented invention by not licensing others to use the invention, or by granting licenses under special conditions designed to preserve that exclusivity.
5. The commercial relationship between the licensor and the licensee, such as whether or not they are competitors in the same territory in the same line of business.
6. The effect of selling the patented product in promoting sales of other products of the licensee; the existing value of the invention to the licensor as a generator of sales of its non-patented items; and the extent of such collateral sales.
7. The duration of the [abbreviated patent number] patent and the term of the license.
8. The established profitability of the product made under the [abbreviated patent number] patent; its commercial success; and its current popularity.
9. The utility and advantages of the patented invention over the old modes or devices, if any that had been used for achieving similar results.
10. The nature of the patented invention; the character of the commercial embodiment of it as owned and produced by the licensor; and the benefits to those who have used the invention.
11. The extent to which [the Defendant] has made use of the invention; and any evidence that shows the value of that use.
12. The portion of the profit or of the selling price that may be customary in the particular business or in comparable businesses to allow for the use of the invention or analogous inventions.
13. The portion of the profit that arises from the patented invention itself as opposed to profit arising from unpatented features, such as the manufacturing process, business risks, or significant features or improvements added by the accused infringer.
14. The opinion testimony of qualified experts.
15. The amount that a licensor and a licensee (such as [the Defendant]) would have agreed upon (at the time the infringement began) if both sides had been reasonably and voluntarily trying to reach an agreement; that is, the amount which a prudent licensee—who desired, as a business proposition, to obtain a license to manufacture and sell a

particular article embodying the patented invention—would have been willing to pay as a royalty and yet be able to make a reasonable profit and which amount would have been acceptable by a patentee who was willing to grant a license.

16. Any other economic factor that a normally prudent business person would, under similar circumstances, take into consideration in negotiating the hypothetical license.

Ericsson, Inc. v. D-Link Sys., Inc., No. 10-CV-0473, 2014 U.S. App. LEXIS 22778 at *65-69 (Fed. Cir. 2014); *Apple Inc. et al v. Motorola Inc., et al.*, ___ F.3d ___ (Fed. Cir. Apr. 25, 2014); *LaserDynamics, Inc. v. Quanta Computer, Inc. et al*, 694 F.3d 51, 60 (Fed. Cir. 2012); *Wordtech Sys., Inc. v. Integrated Networks Solutions, Inc.*, 609 F.3d 1308, 1319 (Fed. Cir. 2010); *ResQNet.com, Inc. v. Lansa, Inc.*, 594 F.3d 860, 869-73 (Fed. Cir. 2010); *Monsanto Co. v. McFarling*, 488 F.3d 973 (Fed. Cir. 2007); *Maxwell v. J. Baker, Inc.*, 86 F.3d 1098, 1108-10 (Fed. Cir. 1996); *TWM Mfg. Co. v. Dura Corp.*, 789 F.2d 895, 898-900 (Fed. Cir. 1986); *Georgia-Pacific Corp. v. United States Plywood Corp.*, 318 F. Supp. 1116 (S.D.N.Y. 1970), *modified and aff'd sub nom.*, *Georgia Pacific Corp. v. United States Plywood Champion Papers, Inc.*, 446 F.2d 295 (2d Cir. 1971).

11.16 Reasonable Royalty – Attribution

The amount you find as damages must be the value attributable to the patented technology, as distinct from other unpatented features of the accused product, or other factors such as marketing or advertising, or [the Patentee]’s size or market position. In determining the appropriate royalty base and the appropriate royalty rate, the ultimate combination of both the royalty rate and the royalty based must reflect the value attributable to the patented technology. It is not sufficient to use a royalty base that is too high and adjust the damages downward by applying a lower royalty rate. Similarly, it is not appropriate to select a royalty base that is too low and adjust it upward by applying a higher royalty rate. Rather, you must determine an appropriate royalty rate and an appropriate royalty base that reflect the value attributable to the patented technology.

VirnetX, Inc. v. Cisco Sys., Inc., 767 F.3d 1308 (Fed. Cir. 2014); *LaserDynamics, Inc. v. Quanta Computer, Inc. et al*, 694 F.3d 51, 60 (Fed. Cir. 2012).

11.17 Reasonable Royalty – Entire Market Value Rule

A product may have both infringing and non-infringing components. In such products, royalties should be based not on the entire product, but instead on the “smallest salable unit” that practices the patent and has close relation to the claimed invention. Where the smallest salable unit is, in fact, a multi-component product containing several non-infringing features with no relation to the patented feature, damages must only be based on portion of the value of that product is attributable to

the patented technology. This may involve estimating the value of a feature that may not have ever been individually sold.

The entire market value rule is a narrow exception to this general rule. In order to recover damages as a percentage of revenues or profits attributable to the entire product, [the Patentee] must establish that it is more likely than not that the patented feature drives the demand for an entire multi-component product.

VirnetX, Inc. v. Cisco Sys., Inc., 767 F.3d 1308, 1326-29 (Fed. Cir. 2014); *LaserDynamics, Inc. v. Quanta Computer, Inc. et al*, 694 F.3d 51, 67 (Fed. Cir. 2012); *Uniloc USA, Inc. v. Microsoft Corp.*, 632 F.3d 1292, 1318 (Fed. Cir. 2011); *Lucent Techs., Inc. v. Gateway, Inc.*, 580 F.3d 1301, 1336-37 (Fed. Cir. 2009); *Rite-Hite Corp. v. Kelley Co.*, 56 F.3d 1538, 1549-51 (Fed. Cir. 1995) (*en banc*).

11.18 Reasonable Royalty – Multiple Patents

If you find that [the Defendant] infringed multiple patents, even by a single infringing act and if you award a reasonable royalty for the infringement, then you may award separate royalties to [the Plaintiff] for each patent that was infringed. You also may consider the number of patent licenses that are needed for the allegedly infringing product and the effect on the hypothetical negotiation of having to pay a royalty for each of those licenses.

Stickle v. Heublein, Inc., 716 F.2d 1550, 1561 n.8 (Fed. Cir. 1983); *Integra Lifesciences I, Ltd. v. Merck KGaA*, 331 F.3d 860, 871 (Fed. Cir. 2003), *reversed on other ground*, *Merck KGaA v. Integra Lifesciences I, Ltd.*, 545 U.S. 193 (2005); *Verizon Servs. Corp. v. Vonage Holdings Corp.*, 503 F.3d 1295, 1310 (Fed. Cir. 2007).

11.19 Reasonable Royalty – Timing

Although the relevant date for the hypothetical license negotiation is just before the infringement began, you may consider evidence relating to events after the infringement began, any actual profits made by [the Defendant] due to its infringement and any commercial success of the patented invention or the infringing products after that date

Lucent Techs., Inc. v. Gateway, Inc., 580 F.3d 1301, 1324-25 (Fed. Cir. 2009); *TWM Mfg. Co. v. Dura Corp.*, 789 F.2d 895, 898-900 (Fed. Cir. 1986); *Studiengesellschaft Kohle, mbH v. Dart Indus., Inc.*, 862 F.2d 1564, 1570-72 (Fed. Cir. 1988); *Fromson v. W. Litho Plate & Supply Co.*, 853 F.2d 1568, 1575-76 (Fed. Cir. 1988), *overruled on other grounds* by *Knorr-Bremse Systeme Fuer Nutzfahrzeuge v. Dana Corp.*, 383 F.3d 1337, 1342 (Fed. Cir. 2004).

11.20 Reasonable Royalty – Availability of Non-Infringing Substitutes

In determining a reasonable royalty, you may also consider evidence concerning the availability and cost of non-infringing alternatives to the patented inven-

tion. A non-infringing alternative must be an acceptable product that is licensed under the patent or that does not infringe the patent.

Uniloc USA, Inc. v. Microsoft Corp., 632 F.3d 1292, 1313 (Fed. Cir. 2011); *Mars, Inc. v. Coin Acceptors, Inc.*, 527 F.3d 1359, 1372-73 (Fed. Cir. 2008); *Zygo v. Wyko*, 79 F.3d 1563, 1571-72 (Fed. Cir. 1996).

11.21 Reasonable Royalty – Use of Comparable License Agreements

When determining a reasonable royalty, you may consider evidence concerning the amounts that other parties have paid for rights to the patent[s] in question, or for rights to similar technologies. A license agreement must not be perfectly comparable to a hypothetical license that would be negotiated between [the Plaintiff] and [the Defendant] in order for you to consider it. However, if you choose to rely upon evidence from any other license agreements, you must account for any differences between those licenses and the hypothetically negotiated license between [the Plaintiff] and [the Defendant], in terms of the technologies and economic circumstances of the contracting parties, when you make your reasonable royalty determination.

Ericsson, Inc. v. D-Link Sys., Inc., No. 10-CV-0473, 2014 U.S. App. LEXIS 22778 at *57-59 (Fed. Cir. 2014); *VirnetX, Inc. v. Cisco Sys., Inc.*, 767 F.3d 1308, 1330-31 (Fed. Cir. 2014); *Apple Inc. et al v. Motorola Inc., et al.*, 757 F.3d 1286, 1325-26 (Fed. Cir. Apr. 25, 2014); *LaserDynamics, Inc. v. Quanta Computer, Inc. et al*, 694 F.3d 51, 77-81 (Fed. Cir. 2012); *ResQNet.com, Inc. v. Lansa, Inc.*, 594 F.3d 860, 869-70 (Fed. Cir. 2010); *Lucent Techs., Inc. v. Gateway, Inc.*, 580 F.3d 1301, 129, 1336 (Fed. Cir. 2009).

11.22 Doubts Resolved Against Infringer

Any doubts that you may have on the issue of damages due to [the Defendant]’s failure to keep proper records should be decided in favor of [the Plaintiff]. Any confusion or difficulties caused by [the Defendant]’s records also should be held against [the Defendant], not [the Plaintiff].

Sensonics, Inc. v. Aerosonic Corp., 81 F.3d 1566, 1572-73 (Fed. Cir. 1996); *Lam, Inc. v. Johns-Manville Corp.*, 718 F.2d 1056, 1065 (Fed. Cir. 1983).

11.23 Standards Essential Patents

Practice Note: Substantial recent attention has been given to the appropriate royalty rate for Standards-Essential Patents (SEPs). Although several district courts have applied the *Georgia-Pacific* factors in assessing a Fair Reasonable and Non-Discriminatory (FRAND or RAND) royalty rate, the Federal Circuit has held some *Georgia-Pacific* factors may not be relevant. Rather, the jury must be instructed on the particulars of the FRAND commitment

made by the patentee, on established principles of patent law, and on those *Georgia-Pacific* factors that may be relevant. The jury must not be instructed on any factors that are not relevant to the determination of the royalty. The jury must be instructed on apportionment of the value of the portion of the standard as a whole to which the patented technology relates. Finally, the jury must be instructed on apportionment of the value of the patented technology and not the value added by standardization. These will typically be fact-specific issues that will depend on the facts of the individual case. *Ericsson, Inc. v. D-Link Systems, Inc.*, 773 F.3d 1201 (Fed. Cir 2014).

12. Willful Infringement

12.0 Willful Infringement – Generally

Practice Note: The following instruction should be given only if the patent owner contends willful infringement and has introduced sufficient evidence to support this contention.

If you find that it is more likely than not that [the Defendant] infringed [the Plaintiff]’s patent, either literally or under the doctrine of equivalents, then you must also determine whether or not [the Defendant]’s infringement was willful. In contrast to proving that infringement is more likely than not, [the Patentee] must prove willfulness by clear and convincing evidence. Willfulness requires clear and convincing evidence that:

1. [The Defendant] acted despite an objectively high likelihood that its actions infringed a valid patent; and
2. This objectively high likelihood of infringement was either known or so obvious that it should have been known to [the Defendant].

In making the determination of whether [the Defendant] acted despite an objectively high likelihood that its actions infringed a valid patent, you are to consider what a reasonable person would have believed and are not to consider [the Defendant]’s actual state of mind.

Practice Note: In *Bard*, the Federal Circuit stated “the objective determination of recklessness, ... is best decided by the judge....,” 682 F.3d at 1007, and that “the judge may when the defense is a question of fact or a mixed question of law and fact allow the jury to determine the underlying facts relevant to the defense in the first instance.... But, ... the ultimate legal question of whether a reasonable person would have considered there to be a high likeli-

hood of infringement of a valid patent should always be decided as a matter of law by the judge.” *Id.* at 1008. “The judge remains the final arbiter of whether the defense was reasonable, even when the underlying fact question is sent to a jury.” *Id.* at 1007. *But cf. Powell v. Home Depot USA, Inc.*, 663 F.3d 1221, 1236-37 (Fed. Cir. 2011) (“Under the objective prong, the answer to whether an accused infringer’s reliance on a particular issue or defense is reasonable is a question for the court when the resolution of that particular issue or defense is a matter of law.

Should the court determine that the infringer’s reliance on a defense was not objectively reckless, the question of willfulness should not be sent to the jury because the objective prong is a predicate to the subjective prong. When the resolution of a particular issue or defense is a factual matter, however, such as whether or not reliance on that issue or defense was reasonable under the objective prong, the issue is properly considered by the jury.

In circumstances, then, where separate issues of fact and law are presented by an alleged infringer as defenses to willful infringement, the objective recklessness inquiry may require analysis by both the court and the jury. For instance, in this case, certain components of the case were before the jury, while others were not. The court decided issues of claim construction and inequitable conduct, neither of which was before the jury. Thus, while the jury was in a position to consider how the infringement case weighed in the objective prong analysis, on other components—such as claim construction—the objective prong question was properly considered by the court.”⁴⁵ (citations omitted).

In determining whether [the Defendant] knew of the objectively high likelihood of infringement or whether the likelihood was so obvious that [the Defendant] should have known of that likelihood, you must consider the totality of the circumstances. The totality of the circumstances comprises a number of factors, which include, but are not limited to, whether [the Defendant] intentionally copied the claimed invention or a product covered by patent, whether [the Defendant] relied on competent legal advice, and whether [the Defendant] presented a substantial defense to infringement, including the defense that the patent is invalid [or unenforceable].

45. As the earlier case, *Powell* is controlling precedent. *See Deckers Corp. v. U.S.*, No. 2013-1356, Slip. Op. at *27 (Fed. Cir. May 13, 2014) (“We have also adopted the rule that a panel of this court—which normally sits in panels of three, and not en banc—is bound by the precedential decisions of prior panels unless and until overruled by an intervening Supreme Court or en banc decision.”). *Compare Scripps Clinic & Res. Found v. Genentech, Inc.*, 927 F.2d 1565 (Fed. Cir. 1991) with *Atlantic Thermoplastics Co. v. Faytex Corp.*, 970 F.2d 834 (Fed. Cir. 1992).

Bard Peripheral Vascular, Inc. v. W.L. Gore & Assocs., Inc., 682 F.3d 1003, 1006-08 (Fed. Cir. 2012); *Powell v. Home Depot USA, Inc.*, 663 F.3d 1221, 1236-37 (Fed. Cir. 2011); *i4i Ltd. P'Ship. v. Microsoft Corp.*, 598 F.3d 831, 859-60 (Fed. Cir. 2010); *Spine Solutions, Inc. v. Medtronic Sofamor Danek USA, Inc.*, 620 F.3d 1305, 1319 (Fed. Cir. 2010); *In re Seagate Tech., LLC*, 497 F.3d 1360 (Fed. Cir. 2007) (*en banc*); *Knorr-Bremse Systeme Fuer Nutzfahrzeuge GmbH v. Dana Corp.*, 383 F.3d 1337, 1347 (Fed. Cir. 2004) (*en banc*).

12.1 Willful Infringement – Absence of Legal Opinion

Practice Note: The following instruction should be given only if the Defendant does not claim reliance on a legal opinion to rebut willfulness.

In considering the totality of the circumstances whether [the Defendant] acted willfully, you may consider as one factor whether [the Defendant] obtained a competent legal opinion. The absence of a legal opinion is one factor that may be considered.

You may not assume that merely because [the Defendant] did not obtain a legal opinion, that the opinion would have been unfavorable. The absence of a lawyer's opinion is not sufficient for you to find that [the Defendant] acted willfully. Rather, the issue is whether the Defendant had a good faith belief that they were not infringing or that the asserted patent was invalid. An opinion of counsel is not necessary for [the Defendant] to establish this defense.

Spectralytics, Inc. v. Cordis Corp., 649 F.3d 1336, 1347-48 (Fed. Cir. 2011); *Aspex Eyewear, Inc. v. Clariti Eyewear, Inc.*, 605 F.3d 1305, 1313 (Fed. Cir. 2010); *In re Seagate Tech., LLC*, 497 F.3d 1360 (Fed. Cir. 2007) (*en banc*).

* * *

VI. Acknowledgments

The contributions of the following attorneys to the drafting and commenting on of these model jury instructions are gratefully acknowledged.

The 1997 Version

Mark Abate	Eileen M. Herlihy	Frederick G. Michaud, Jr.
Ken R. Adamo	Roy E. Hofer	Jeffrey D. Mills
Joseph Z. Allen	Michael K. Kirschner	John B. Pegram
Robert L. Baechtold	Steven S. Korniczky	Michael F. Petock
Russell J. Barron	William E. Lahey	Peter H. Priest
Christopher R. Benson	Bradley G. Lane	Jerrold B. Reilly
David J. Brezner	Robert C. Laurensen	Daniel M. Riess
Henry L. Brinks	Gary H. Levin	William C. Rooklidge
Jeffrey N. Costakos	Jeffrey I.D. Lewis	Alan J. Ross
John F. Delaney	Brent P. Lorimer	John M. Skenyon
Bradford J. Duft	Don W. Martens	Allan Sternstein
Donald R. Dunner	Alice O. Martin	Lawrence M. Sung
Richard D. Fladung	Clifton E. McCann	Jennifer A. Tegfeldt
Floyd A. Gibson	Gaynell C. Methvin	David C. Wright

The 2005 version

Kley Achterhof	Rashida MacMurray	Aaron Weiss
Stephanie Barbosa	Steven Maslowski	Elizabeth Wright
Kelli Deasy	William McGeveran	Jeremy Younkin
Denise DeFranco	George Medlock	
Barbara Fiacco	Mary Beth Noonan	
Katherine Fick	Matthew Pearson	
Mareesa Frederick	Mark Schuman	
Stephanie Harris	Steve Sheldon	
Wendell Harris	Sean Seymour	
Andrew Lagatta	John Skenyon	
Christy Lea	Stephen Timmins	
Kalun Lee	Hema Viswanathan	

Appendix E: Model Patent Jury Instructions

The 2007 version

Aaron Barlow	Joshua Masur	John Schneider
Dave Bennett	Clifton McCann	Mark Schuman
Elaine Hermann Blais	Tim Meece	Jeff Sheldon
Walter Bookhardt	Heather Mewes	John Skenyon
Scott Breedlove	Joe Miller	Steve Swinton
Patrick Coyne	Kenneth Mitchell	Tim Teter
John Crossan	John Moran	Kurt Van Thomme
Elizabeth Day	Jeff Nichols	David Todd
Conor Farley	Scott Pivnick	Michael Valek
John Hintz	Mirriam Quinn	Alastair Warr
Scott Howard	Amber Rovner	Adam Wichman
Kirby Lee	Michael Sacksteder	Daniel Winston
Gregory Lyons	John Scheibeler	Steven Zeller

The 2012 version

Matthew Blackburn	Aleksander Goranin	William Poynter
Elaine Blais	Angie Hankins	Woody Pollack
Carrie Beyer	Ben Hanrahan	Joe Richetti
Gary Buccigross	Ben Hodges	Spencer Ririe
Brian Butler	Lisa Kattan	John Skenyon
Justin Cohen	William Lenz	Laura Smalley
Danielle Coleman	Greg Lewis	Andrew Stein
Craig Countryman	Robert Matthews	Steve Swinton
Tom Davison	John Moy	Lynn Tyler
David DeBruin	Paul Overhauser	Jennifer Vein, Smr.
Evan Finkel	Ajeet Pai	Assoc.
Glenn Forbis	John Pinkerton	Jose Villareal
Nicolas Gikkas	Scott J. Pivnick	Steven Zeller

The 2015 version

Ken Adamo	Rudy Hofmann	Connie Ramos
Aden Allen	Daniel Holmander	Russell Rigby
Alan Anderson	Travis Jensen	Spencer Ririe
Matt Bernstein	Neil Jones	Victor Rodriguez Reyes
Felicia Boyd	James Kamp	David Ruschke
Joshua Brady	Karen Keller	Jeffrey Sadowski
Cheryl Burgess	Nicholas Kim	Javier Sobrado
Kristin Cleveland	Suzanne Konrad	Kim Schenk
Patrick J. Coyne	Samuel Lewis	Michael Strapp
David De Bruin	David Moore	Mark Supko
Denise DeFranco	Jeffrey Mote	Stephen Swinton
Larry DeMeo	Don Niles	Jamaica Szeliga
Alper Ertas	Eric Osterberg	Peter Toren
Peter Forrest	Paul Overhauser	Christopher Tokarczyk
Aaron Frankel	Ajeet Pai	Steven Trybus
Gary Frischling	Henrik Parker	Colette Verkuil
Mel Garner	Ken Parker	Mark Whitaker
Derek Gilliland	Roger Parkhurst	A. Robert Weaver
James Goggin	John Pegram	Steven McMahon Zeller
David Harth	Rafael A. Perez-Pineiro	RJ Zayed
Anthony Hartmann	Scott J. Pivnick	

Table of Cases

3COM Corp v. D-Link Systems, Inc., No. C 03-2177 VRW, 2007 WL 949596, 2007 U.S. Dist. LEXIS 26542 (N.D. Cal. Mar. 27, 2007), 2-42

3M Innovative Props. Co. v. Avery Dennison Corp., 350 F.3d 1365 (Fed. Cir. 2003), 5-74

800 Adept, Inc. v. Murex Sec., Ltd., 539 F.3d 1354 (Fed. Cir. 2008), 5-69

A & L Tech. v. Resound Corp., Case No. C 93-00107 CW, 1995 U.S. Dist. LEXIS 22443, at *11, 1995 WL 415146 (N.D. Cal. June 29, 1995), 8-25

A & L Tech. v. Resound Corp., 1995 U.S. Dist. LEXIS 22442, 1995 WL 415146 (N.D. Cal. Mar. 15, 1995), 9-19

A.B. Dick Co. v. Burroughs Corp., 713 F.2d 700 (Fed. Cir. 1983), 5-93

A.C. Aukerman Co. v. R.L. Chaides Constr. Co., 960 F.2d 1020 (Fed. Cir. 1992), 6-4, 6-27, 14-95, 14-96

aaiPharma, Inc. v. Kremers Urban Dev. Co., 361 F. Supp. 2d 770 (N.D. Ill. 2005), 4-30

aaiPharma, Inc. v. Thompson, 296 F.3d 227 (4th Cir. 2001), 10-4

Abbott Diabetes Care Inc. v. Roche Diagnostics Corp., 2007 WL 2221029, 2007 U.S. Dist. LEXIS 59161 (N.D. Cal. July 30, 2007), 2-42

Abbott Laboratories v. Andrx Pharm., Inc., 452 F.3d 1331 (Fed. Cir. 2006), 3-9, 3-16, 14-102

Abbott Laboratories v. Dey, L.P., 287 F.3d 1097 (Fed. Cir. 2002), 14-85

Abbott Laboratories v. Dey, L.P., 110 F. Supp. 2d 667 (1980), 5-91, 5-92

Abbott Laboratories v. Diamedix Corp., 47 F.3d 1128 (Fed. Cir. 1995), 2-31

Abbott Laboratories v. Geneva Pharm., 182 F.3d 1315 (Fed. Cir. 1999), 14-59

Abbott Laboratories v. Sandoz, 566 F.3d 1282 (Fed. Cir. 2009), 5-61, 5-82, 5-83

Abbott Laboratories v. Sandoz, Inc., 500 F. Supp. 2d 846 (N.D. Ill. 2007), 3-30

Abbott Laboratories v. Torpharm, Inc., 503 F.3d 1372 (Fed. Cir. 2007), 9-9

AbbVie Deutschland GmbH & Co., KG v. Janssen Biotech, Inc., 759 F.3d 1285 (Fed. Cir. 2014), 7-8

AbbVie Inc. v. Kennedy Inst. of Rheumatology, 764 F.3d 1366 (Fed. Cir. 2014), 14-98

Acacia Media Techs. Corp., *In re*, Nos. M 05-1665 JW, C 05-01114 JW, 2010 U.S. Dist. LEXIS 65297, 2010 WL 2179875 (N.D. Cal. May 25, 2010), 5-18

Accenture Global Servs., GmbH v. Guidewire Software, Inc., 728 F.3d 1336 (Fed. Cir. 2014), 6-9

Acer America Corp., *In re*, 626 F.3d 1252 (Fed. Cir. 2010), 2-62

Acevedo v. Allsup's Convenience Stores, Inc., 600 F.3d 516 (5th Cir. 2010), 2-38

Ackermann v. United States, 340 U.S. 193 (1950), 9-19

Acorda Therapeutics, Inc. v. Mylan Pharm. Inc., 1-14-cv-00935-30, 2015 WL 186833 (D. Del. Jan. 14, 2015), 10-11

ActiveVideo Networks v. Verizon Commc'ns, 694 F.3d 1312 (Fed. Cir. 2012), 9-4

Acumed LLC v. Stryker Corp., 483 F.3d 800 (Fed. Cir. 2007), 5-48, 5-50, 5-61, 5-69

Acumed LLC v. Stryker Corp., 551 F.3d 1323 (Fed. Cir. 2008), 9-3

Adams v. Burke, 84 U.S. 453 (1873), 1-7

Additive Controls & Measurement Systems, Inc. v. Flowdata, Inc., 154 F.3d 1345 (Fed. Cir. 1998), 9-9

Additive Controls & Measurement Systems, Inc. v. Flowdata, Inc., 96 F.3d 1390 (Fed. Cir. 1996), 3-28, 3-31

Adobe Systems, Inc. Sec. Litig., *In re*, 141 F.R.D. 155 (N.D. Cal. 1992), 8-16

ADT Corp. v. Lydall, Inc., 159 F.3d 534 (Fed. Cir. 1998), 7-46

Patent Case Management Judicial Guide, Third Edition

Advanced Cardiovascular Systems v. Medtronic Vascular, Inc., 579 F. Supp. 2d 554 (D. Del. 2008), 9-3
Advanced Cardiovascular Systems, Inc. v. Medtronic, Inc., 265 F.3d 1294 (Fed. Cir. 2001), 2-15, 2-46, 5-38, 9-11
Advanced Display Systems, Inc. v. Kent State Univ., 212 F.3d 1272 (Fed. Cir. 2000), 8-17
Advanced Software Design Corp. v. Fed. Reserve Bank of St. Louis, 583 F.3d 1371 (Fed. Cir. 2009), 13-5–13-6
Aero Products Int'l, Inc. v. Intex Recreation Corp., 466 F.3d 1000 (Fed. Cir. 2006), 5-23
Aetna Life Ins. Co. v. Haworth, 300 U.S. 227 (1937), 2-34
AFG Industries, Inc. v. Cardinal IG Co., 239 F.3d 1239 (Fed. Cir. 2001), 5-28, 5-73, 5-74, 5-75
AFTG-TG, LLC v. Nuvoton Tech. Corp., 689 F.3d 1358 (Fed. Cir. 2012), 2-59
Agfa Corp. v. Creo Prods., Inc., 451 F.3d 1366 (Fed. Cir. 2006), 5-61, 5-65, 8-4
Agrizap, Inc. v. Woodstream Corp., 520 F.3d 1337 (Fed. Cir. 2008), 7-10, 7-12, 8-32, 14-72
Aguilar v. Int'l Longshoremen's Union Local 10, 966 F.2d 443 (9th Cir. 1992), 7-28
AIA Engineering Ltd. v. Magotteaux Int'l, 657 F.3d 1264 (Fed. Cir. 2011), 5-40, 5-41
AK Steel Corp. v. Sollac, 344 F.3d 1234 (Fed. Cir. 2003), 5-76
Akamai Technologies, Inc. v. Limelight Networks, Inc., 797 F.3d 1020 (Fed. Cir. 2015) (en banc), 14-80
Akamai Technologies, Inc. v. Limelight Networks, Inc., 134 S. Ct. 2111 (2014), 14-78, 14-79
Akamai Technologies, Inc. v. Limelight Networks, Inc., 629 F.3d 1311 (Fed. Cir. 2010), 6-15, 6-40, 7-17
Al-Site Corp. v. VSI Int'l, Inc., 174 F.3d 1308 (Fed. Cir. 1999), 6-27, 8-25, 14-86, 14-87
Alappat, *In re*, 33 F.3d 1526 (Fed. Cir. 1994), 14-40
Alcan International Ltd. v. S.A. Day Mfg. Co., Inc., 176 F.R.D. 75 (W.D.N.Y. 1996), 4-14
Alcon Laboratories, Inc. v. Pharmacia Corp., 225 F. Supp. 2d 340 (S.D.N.Y. 2002), 4-30
Alemite Manufacturing Co. v. Staff, 42 F.2d 832 (2d Cir. 1930), 3-28
Alexander v. Nat'l Farmers Org., 687 F.2d 1173 (8th Cir. 1982), 4-42
Alice Corp. Pty. Ltd. v. CLS Bank Int'l, 134 S. Ct. 2347 (2014), 1-1–1-2, 2-76, 6-9, 6-17, 6-19, 6-30–6-32, 14-29, 14-30, 14-43, 14-44
Allen v. Zurich Ins. Co., 667 F.2d 1162 (4th Cir. 1982), 5-97
Allen-Bradley Co. v. Kollmorgen Corp., 199 F.R.D. 316 (E.D. Wis. 2001), 5-101
Allergan, Inc. v. Alcon Labs., Inc., 324 F.3d 1322 (Fed. Cir. 2003), 10-15
Allergan, Inc. v. Apotex, Inc., 754 F.3d 952 (Fed. Cir. 2014), 7-11
Alloc, Inc. v. Int'l Trade Comm'n, 342 F.3d 1361 (Fed. Cir. 2003), 5-65
Alloc, Inc. v. Pergo, Inc., 2007 U.S. Dist. LEXIS 5183, 2007 WL 5289735 (E.D. Wis. Nov. 21, 2007), 7-57
Alloc, Inc. v. Unilin Decor, N.V. 2003 U.S. Dist. LEXIS 11917, 2003 WL 21640372 (D. Del. 2003), 2-50
Already, LLC v. Nike, Inc., 133 S. Ct. 721 (2013), 2-32, 2-33
Altana Pharma AG v. Teva Pharm. USA, Inc., 566 F.3d 999 (Fed. Cir. 2009), 10-6, 14-73
Alton, *In re*, 76 F.3d 1168, 1172 (Fed. Cir. 1996), 14-47
Alza Corp. v. AndrX Pharm., LLC., 603 F.3d 935 (Fed. Cir. 2010), 6-8
Amado v. Microsoft Corp., 2008 U.S. Dist. LEXIS 110152, 2008 WL 8641264 (C.D. Cal. Dec. 4, 2008), 9-8
Amado v. Microsoft Corp., 517 F.3d 1353 (Fed. Cir. 2008), 9-7, 9-8, 9-20
Amazon.com, Inc. v. Barnesandnoble.com, Inc., 239 F.3d 1343 (Fed. Cir. 2001), 3-5, 3-9, 3-10, 3-11, 3-16
AMC Technology, LLC v. Cisco Systems, Inc., No. 11-3403 PSG, 2013 U.S. Dist. LEXIS 101372, 2013 WL 3733390 (N.D. Cal. July 15, 2013), 4-21
American Hoist & Derrick Co. v. Sowa & Sons, 725 F.2d 1350 (Fed. Cir. 1984), 8-25, 8-31, 14-69

Table of Cases

American Medical Systems, Inc. v. Med. Eng'g Corp., 6 F.3d 1523 (Fed. Cir. 1993), 14-110, 14-111
American Piledriving Equip., Inc. v. Geoquip, Inc., 637 F.3d 1324 (Fed. Cir. 2011), 5-24, 5-28, 5-44
American Seating Co. v. USSC Grp., Inc., 514 F.3d 1262 (Fed. Cir. 2008), 14-104
Ameritox Ltd. v. Millennium Health, LLC, 2015 U.S. Dist. LEXIS 19665, 2015 WL 728501 (W.D. Wisc. Feb. 18, 2015), 6-18, 14-44
Amgen Inc. v. Apotex Inc., No. 16-1308, ___ F.3d ___ (Fed. Cir. 2016), 10-36
Amgen Inc. v. Hoechst Marion Roussel, Inc., 469 F.3d 1039 (Fed. Cir. 2006), 5-4
Amgen Inc. v. Hoechst Marion Roussel, Inc., 314 F.3d 1313 (Fed. Cir. 2003), 5-74, 14-47
Amgen Inc. v. Sandoz Inc., 794 F.3d 1347 (Fed. Cir. 2015), 10-28, 10-30, 10-33, 10-35, 10-36
Amgen, Inc. v. Chugai Pharm. Co., 927 F.2d 1200 (Fed. Cir. 1991), 14-40, 14-49
Amgen, Inc. v. F. Hoffmann–La Roche Ltd., 581 F. Supp. 2d 160 (D. Mass. 2008), 9-8
Amgen, Inc. v. F. Hoffmann–La Roche Ltd., 494 F. Supp. 2d 54 (D. Mass. 2007), 5-98, 5-99
Amgen, Inc. v. Hoechst Marion Roussel, Inc., 339 F. Supp. 2d 202 (D. Mass. 2004), 8-11
Amicus Communications, L.P. v. Hewlett-Packard Co., No. 99-0284 HHK/DAR, 1999 WL 33117227, 1999 U.S. Dist. LEXIS 20901 (D.D.C. Dec. 3, 1999), 4-30
Amini Innovation Corp. v. Anthony Cal., Inc., 439 F.3d 1365 (Fed. Cir. 2006), 11-8
Amsted Industries, Inc. v. Buckeye Steel Castings Co., 24 F.3d 178 (Fed. Cir. 1994), 9-11, 14-110
Anchor Plastics Co. v. Dynex Indus. Plastics Corp., 184 U.S.P.Q. (BNA) 482 (D.N.J. 1974), 4-31
Anchor Wall Systems v. Rockwood Retaining Walls, Inc., 340 F.3d 1298 (Fed. Cir. 2003), 5-50
Andersen Corp. v. Fiber Composites, LLC, 474 F.3d 1361 (Fed. Cir. 2007), 5-59, 5-65, 5-69, 5-70
Andrews, *Ex parte*, 1917 Comm'n Dec. 13 (Comm'r Dec. Pat. 1916), 11-5
Andrx Pharmaceuticals, Inc. v. Biovail Corp. Int'l, 256 F.3d 799 (D.C. Cir. 2001), 10-20
Andrx Pharmaceuticals, Inc. v. Biovail Corp., 276 F.3d 1368 (Fed. Cir. 2002), 10-2, 10-6, 10-7, 10-15
Andrx Pharmaceuticals, Inc., *In re*, 399 F. App'x 582 (Fed. Cir. 2010), 10-10
Angelo v. Armstrong World Indus., Inc., 11 F.3d 957 (10th Cir. 1993), 8-4
Antonious v. Spalding & Evenflo Cos., Inc., 275 F.3d 1066 (Fed. Cir. 2002), 4-24, 4-25
Apotex, Inc. v. Pfizer Inc., 385 F. Supp. 2d 187 (S.D.N.Y. 2005), 10-7
Apotex, Inc. v. Thompson, 347 F.3d 1335 (Fed. Cir. 2003), 10-7
Apotex, Inc., *In re*, 49 F. App'x 902 (Fed. Cir. 2002), 10-10
Apple Inc. v. Samsung Elecs. Co. (*Apple II*), 695 F.3d 1370 (Fed. Cir. 2012), 3-11, 3-14, 14-102
Apple Inc. v. Samsung Elecs. Co. (*Apple III*), 735 F.3d 1352 (Fed. Cir. 2013), 3-7, 3-12, 3-14, 3-16, 9-2, 14-102, 14-103
Apple Inc. v. Samsung Elecs. Co., 786 F.3d 983 (Fed. Cir. 2015), 11-6, 11-14
Apple Inc. v. Samsung Elecs. Co., 801 F.3d 1352 (Fed. Cir. 2015), 9-2, 14-103
Apple Inc. v. Samsung Elecs. Co., Ltd., No. 5:11-CV-01846 (N.D. Cal. Nov. 18, 2014), 4-10
Apple Inc. v. Samsung Elecs., Co., 2014 U.S. Dist. LEXIS 24506, 2014 WL 794328 (N.D. Cal. Feb. 25, 2014), 7-38
Apple, Inc. v. Motorola, Inc., 757 F.3d 1286 (Fed. Cir. 2014), 1-2, 3-11, 5-39, 5-82, 7-23, 7-32, 7-33, 8-33, 8-34, 8-36, 8-37, 8-38, 9-4, 14-107, 14-108
Apple, Inc. v. Samsung Elecs. Co. (*Apple I*), 678 F.3d 1314 (Fed. Cir. 2012), 3-11, 3-12, 3-14, 11-8, 11-12, 11-14, 14-102
Apple, Inc. v. Samsung Elecs. Co., 932 F. Supp. 2d 1076 (N.D. Cal. 2013), 5-9
Applera Corp. v. MJ Research, Inc., 389 F. Supp. 2d 344 (D. Conn. 2005), 7-46, 8-10, 8-11

Patent Case Management Judicial Guide, Third Edition

- Applied Materials, Inc. v. Advanced Semiconductor Materials Am., Inc., 98 F.3d 1563 (Fed. Cir. 1996), 14-97
- Applied Materials, Inc. v. Advanced Semiconductor Materials Am., Inc., No. 92-20643, 1995 U.S. Dist. LEXIS 22335, 1995 WL 261407 (N.D. Cal. Apr. 25, 1995), 8-25
- Aqua Shield v. Inter Pool Cover Team, 774 F.3d 766 (Fed. Cir. 2014), 3-6, 8-37, 14-108
- Aquatex Industries, Inc. v. Techniche Solutions, 419 F.3d 1374 (Fed. Cir. 2005), 7-40
- Arc'teryx Equipment, Inc. v. Westcomb Outerwear, Inc., 2008 U.S. Dist. LEXIS 90228, 2008 WL 4838141 (D. Utah Nov. 4, 2008), 11-9
- Archive Corp. v. Cipher Data Prods., Inc., CIV A Nos. SACV88296AHSRWRX, SACV88472AHSRRS, 1988 WL 168533, 1988 U.S. Dist. LEXIS 17190 (C.D. Cal. Dec. 22, 1988), 3-8
- Arey v. Goodyear Tire & Rubber Co., 11 F.R.D. 209 (N.D. Ohio 1951), 2-39
- Aria Diagnostics, Inc. v. Sequenom, Inc., 726 F.3d 1296 (Fed. Cir. 2013), 3-11, 3-12, 3-15
- Ariad Pharmaceuticals, Inc. v. Eli Lilly & Co., 598 F.3d 1336 (Fed. Cir. 2010), 14-47, 14-48
- Ariba, Inc. v. Emptoris, Inc., 567 F. Supp. 2d 914 (E.D. Tex. 2008), 9-8
- Ariosa Diagnostics, Inc. v. Sequenom, Inc., 788 F.3d 1371 (Fed. Cir. 2015), 14-30
- Aristocrat Technologies Austl. Pty. Ltd. v. Int'l Game Tech., 521 F.3d 1328 (Fed. Cir. 2008), 5-82, 6-36
- Aristocrat Technologies Austl. Pty. Ltd. v. Int'l Game Tech., 709 F.3d 1348 (Fed. Cir. 2013), 2-77
- Arkansas Carpenters Health & Welfare Fund v. Bayer AG, 625 F.3d 779 (2d Cir. 2010), 10-21
- Arkema Inc. v. Honeywell International Inc., 706 F.3d 1351 (Fed. Cir. 2013), 2-34
- Arlington Industries Inc. v. Bridgeport Fittings, 632 F.3d 1246 (Fed. Cir. 2011), 5-67
- Arminak & Ass'n, Inc. v. Saint-Gobain Calmar, Inc., 501 F.3d 1314 (Fed. Cir. 2007), 11-9
- Arnold, *In re*, 185 F.2d 686 (C.C.P.A. 1950), 14-35
- Aro Manufacturing Co. v. Convertible Top Replacement Co., 365 U.S. 336 (1961), 5-58
- Aro Manufacturing Co. v. Convertible Top Replacement Co., 377 U.S. 476 (1964), 7-16, 7-17, 14-79, 14-90
- Arthrocare Corp. v. Smith & Nephew, Inc., 315 F. Supp. 2d 615 (D. Del. 2004), 9-20
- Arthur A. Collins, Inc. v. N. Telecom, Ltd., 216 F.3d 1042 (Fed. Cir. 2000), 6-26
- Asahi Metal Industry Co. v. Superior Court of California, Solano County, 480 U.S. 102 (1987), 2-59
- Asgrow Seed Co. v. Winterboer, 513 U.S. 179 (1995), 12-10
- Ashcroft v. Iqbal, 556 U.S. 662 (2009), 2-40
- Ashley v. Weeks-Numan Co., 220 F. 899 (2d Cir. 1915), 11-9
- Aspex Eyewear, Inc. v. Clariti Eyewear, Inc., 605 F.3d 1305 (Fed. Cir. 2010), 9-10
- Aspex Eyewear, Inc. v. Zenni Optical Inc., 731 F.3d 1377 (Fed. Cir. 2013), 5-91
- Association for Molecular Pathology v. Myriad Genetics, Inc., 133 S. Ct. 2107 (2013), 1-1, 2-76, 6-17, 14-29, 14-43
- Association of Mexican American Educators v. California, 231 F.3d 572 (9th Cir. 2000), 5-19, 8-23
- Astrazeneca AB v. Apotex Corp., 782 F.3d 1324 (Fed. Cir. 2015), 8-38
- AstraZeneca AB v. Aurobindo Pharma Ltd., No. 14-664-GMS, 2014 WL 7533913 (D. Del. Dec. 17, 2014), 10-11
- AstraZeneca AB v. Mylan Pharmaceuticals, No. 14-664-GMS, 2014 WL 5778016 (D. Del. Nov. 5, 2014), 10-10
- AstraZeneca LP v. Apotex, Inc., 633 F.3d 1042 (Fed. Cir. 2010), 3-10, 3-11, 10-4, 14-101

Table of Cases

AstraZeneca Pharmaceuticals LP v. Apotex Corp., 669 F.3d 1370 (Fed. Cir. 2012), 10-3, 10-4, 10-5, 10-11

AstraZeneca Pharmaceuticals, LP v. Mayne Pharma (USA) Inc., 2005 U.S. Dist. LEXIS 26196, 2005 WL 2864666 (S.D.N.Y. Nov. 2, 2005), 14-68

Asyst Technologies, Inc. v. Empak, Inc., 268 F.3d 1364 (Fed. Cir. 2001), 6-9

Asyst Technologies, Inc. v. Emtrak, Inc., 544 F.3d 1310 (Fed. Cir. 2008), 14-75

Ateliers de la Haute-Garonne v. Broetje Automation-USA, Inc., No. 09-cv-598, 2015 U.S. Dist. LEXIS 39850, 2015 WL 1022745 (D. Del. Mar. 30, 2015), 9-15

Athletic Alternatives, Inc. v. Prince Mfg., Inc., 73 F.3d 1573 (Fed. Cir. 1996), 2-23

Atlantic Thermoplastics Co. v. Faytex Corp., 970 F.2d 834 (Fed. Cir. 1992), 5-82

Atlantic Works v. Brady, 107 U.S. (17 Otto) 192 (1883), 1-7

Atlas Powder Co. v. E.I. du Pont De Nemours & Co., 750 F.2d 1569 (Fed. Cir. 1984), 5-75

Atlas Powder Co. v. Ireco Chems., 773 F.2d 1230 (Fed. Cir. 1985), 3-8, 3-28

Atmel Corp. v. Information Storage Devices Inc., No. C 95-1987 FMS, 1998 WL 775115, 1998 U.S. Dist. LEXIS 17564 (N.D. Cal. Nov. 5, 1998), 2-42

Atmel Corp. v. Information Storage Devices, Inc., 198 F.3d 1374 (Fed. Cir. 1999), 5-87

Atofina v. Great Lakes Chemical Corp., 441 F.3d 991 (Fed. Cir. 2006), 5-68, 14-52

Auerbach v. Sverdrup Corp., 829 F.2d 175 (D.C. Cir. 1987), 13-5

August Technology Corp. v. Camtek, Ltd., 655 F.3d 1278 (Fed. Cir. 2011), 5-60

Auto Wax Co. v. Mark V Prods., Case No. 99-cv-0982, 2001 WL 292597 (N.D. Tex. Mar. 14, 2001), 8-29

Automatic Radio Manufacturing Co. v. Hazeltine Research, Inc., 339 U.S. 827 (1950), 14-99

Automotive Technology International v. BMW, 501 F.3d 1274 (Fed. Cir. 2007), 14-49

Avago Technologies General IP PTE Ltd. v. Elan Microelectronics Corp., No. C04-05385 JW (HRL), 2007 WL 1449758, 2007 U.S. Dist. LEXIS 39543 (N.D. Cal. May 15, 2007), 2-42

Aventis Pharma Deutschland v. Lupin, Ltd., 499 F.3d 1293 (Fed. Cir. 2007), 14-73

Avia Group Int'l, Inc. v. L.A. Gear Cal., Inc., 853 F.2d 1557 (Fed. Cir. 1988), 7-9, 11-10

Azure Networks, LLC v. CSR PLC, 771 F.3d 1336 (Fed. Cir. 2014), 5-61, 5-78

B & H Mfg., Inc. v. Foster-Forbes Glass Co., 143 F.R.D. 664 (N.D. Ind. 1992), 4-8

B. Braun Medical, Inc. v. Abbott Labs., 124 F.3d 1419 (Fed. Cir. 1997), 6-4

Baker v. Farmers Elec. Coop., Inc., 34 F.3d 274 (5th Cir. 1994), 2-61

Baladevon, Inc. v. Abbott Laboratories, Inc., 871 F. Supp. 89 (D. Mass. 1994), 14-100

Baldwin Graphic Systems, Inc. v. Siebert, Inc., 512 F.3d 1338 (Fed. Cir. 2008), 5-72, 5-73

Ball Corp. v. United States, 729 F.2d 1429 (Fed. Cir. 1984), 14-21

Baltimore Luggage Co. v. Samsonite Corp., 977 F.2d 571 (4th Cir. 1992), 2-50

Bancorp Services, L.L.C. v. Hartford Life Ins. Co., 359 F.3d 1367 (Fed. Cir. 2004), 5-81, 5-87

Bancorp Services, L.L.C. v. Sun Life Assurance Co., 687 F.3d 1266 (Fed. Cir. 2012), 6-18

BancorpSouth Bank v. Herter, 643 F. Supp. 2d 1041 (W.D. Tenn. 2009), 4-40

Barber, *In re*, 81 F.2d 231, 28 U.S.P.Q. 187 (C.C.P.A. 1936), 11-4

Bard Peripheral Vascular, Inc. v. W.L. Gore & Assocs., 682 F.3d 1003 (Fed. Cir. 2012), 6-45

Bard Peripheral Vascular, Inc. v. W.L. Gore & Assocs., Inc., 670 F.3d 1171 (Fed. Cir. 2012) (en banc), 9-4

Barnes & Noble, Inc., *In re*, 743 F.3d 1381 (Fed. Cir. 2014), 2-63

Barr Laboratories, Inc., *In re*, 930 F.2d 72 (D.C. Cir. 1991), 10-2

Patent Case Management Judicial Guide, Third Edition

- Barrette Outdoor Living v. Michigan Resin Representatives, LLC, No. 11-13335, 2013 U.S. Dist. LEXIS 60309, 2013 WL 1800356 (E.D. Mich. Apr. 29, 2013), 4-22
- Bascom Research LLC v. Facebook, Inc., 2013 U.S. Dist. LEXIS 41429, 2013 WL 968210 (N.D. Cal. Mar. 12, 2013), 2-40
- BASF Agrochemical Prods. v. Unkel, No. 05 CV 1478, 2006 WL 3533133, 2006 U.S. Dist. LEXIS 88672 (W.D. La. Dec. 7, 2006), 12-10
- Bass v. General Motors Corp., 929 F. Supp. 1287 (W.D. Mo. 1996), *aff'd*, 150 F.3d 842 (8th Cir. 1998), 4-42
- Bausch & Lomb, Inc. v. Alcon Labs., Inc., 79 F. Supp. 2d 252 (W.D.N.Y. 2000), 8-24
- Bayer AG v. Schein Pharm., Inc., 301 F.3d 1306 (Fed. Cir. 2002), 14-50
- Bayer Cropscience AG v. Dow Agrosiences LLC, No. 12-256, 2015 U.S. Dist. LEXIS 30752, 2015 WL 1197436 (D. Del. Mar. 13, 2015), 9-12
- Bayer Schering Pharma AG v. Barr Labs, Inc., 575 F.3d 1341 (Fed. Cir. 2009), 7-11, 14-74
- Bayer Schering Pharma AG v. Lupin, Ltd., 676 F.3d 1316 (Fed. Cir. 2012), 10-7
- Board of Trustees of the Leland Stanford Junior Univ. v. Roche Molecular Systems, Inc., 237 F.R.D. 618 (N.D. Cal. 2006), 4-29
- Beacon Theatres, Inc. v. Westover, 359 U.S. 500 (1959), 8-5
- Bear Creek Techs., Inc., *In re*, 858 F. Supp. 2d 1375 (2012), 2-65, 5-27
- Beatrice Foods Co. v. New England Printing & Lithographing Co., 923 F.2d 1576 (Fed. Cir. 1991), 9-10
- Beckman Instruments, Inc. v. LKB Produkter AB, 892 F.2d 1547 (Fed. Cir. 1989), 9-16
- Bedford v. Hunt, 3 F. Cas. 37, No. 1217 (C.C.D. Mass. 1817), 1-6
- Beech-Nut Nutrition Corp. v. Gerber Prods. Co., No. CIV-S-01-1920-GEB-PAN (E.D. Cal. Nov. 18, 2003), 2-6
- Beineke, *In re*, 690 F.3d 1344 (Fed. Cir. 2012), 12-5
- Bell Atlantic Corp. v. Twombly, 550 U.S. 544 (2007), 2-39, 2-40, 14-101
- Bell, *In re*, 991 F.2d 781 (Fed. Cir. 1993), 6-8
- Belotte v. Zayre Corp., 531 F.2d 1100 (1st Cir. 1976), 8-17
- Bender v. Exar Corp., CV 09-01140 (N.D. Cal. Aug. 3, 2009), 2-37
- Bender v. LG Electronics, U.S.A., Inc., 2010 U.S. Dist. LEXIS 33075, 2010 WL 889541 (N.D. Cal. Mar. 11, 2010), 2-41
- Benitec Austl., Ltd. v. Nucleonics, Inc., 495 F.3d 1340 (Fed. Cir. 2007), 2-33
- Bereslavsky v. ESSO Standard Oil Co., 175 F.2d 148 (4th Cir. 1949), 13-5
- Berg, *In re*, 140 F.3d 1428 (Fed. Cir. 1998), 6-4
- Bergstrom v. Sears, Roebuck & Co., 496 F. Supp. 476 (D. Minn. 1980), 11-4
- Best Lock Corp. v. Ilco Unican Corp., 94 F.3d 1563 (Fed. Cir. 1996), 11-3
- Beverly Hills Fan Co. v. Royal Sovereign Corp., 21 F.3d 1558 (Fed. Cir. 1994), 2-60
- Biagro Western Sales, Inc. v. Grow More, Inc., 423 F.3d 1296 (Fed. Cir. 2005), 5-42
- Bicon, Inc. v. Strauman Co., 441 F.3d 945 (Fed. Cir. 2006), 5-71
- Bill of Lading Transmission & Processing Systems Patent Litigation, *In re*, 681 F.3d 1323 (Fed. Cir. 2012), 2-40
- Bilski, *In re*, 545 F.3d 943 (Fed. Cir. 2008), 2-28, 6-17, 14-41
- Bilski v. Kappos, 561 U.S. 593 (2010), 1-1, 2-76, 6-17, 6-18, 6-31, 14-29, 14-41–14-42
- Bio-Engineering Project v. Amgen Inc., 475 F.3d 1256 (Fed. Cir. 2007), 2-30

Table of Cases

Bio-Technology General Corp. v. Genentech, Inc., 80 F.3d 1553 (Fed. Cir. 1996), 7-43
Biomedical Patent Mgmt. Corp. v. Cal. Dep't of Health Servs., 505 F.3d 1328 (Fed. Cir. 2007), 5-97
Biotec Biologische Naturverpackungen GmbH v. Biocorp, Inc., 249 F.3d 1341 (Fed. Cir. 2001), 5-51
Biosig Instruments, Inc. v. Nautilus, Inc., 783 F.3d 1374 (Fed. Cir. 2015), 5-49, 5-85
Black & Decker v. Bosch, No. 04 C 7955, 2006 U.S. Dist. LEXIS 94556, 2006 WL 3883286 (N.D. Ill. Dec. 18, 2006), 8-40
BlackBoard v. Desire2Learn, Inc., 574 F.3d 1371 (Fed. Cir. 2009), 5-82, 8-42
Blisscraft of Hollywood v. United Plastics Co., 294 F.2d 694 (2d Cir. 1961), 11-3
Blonder-Tongue Laboratories, Inc. v. University of Illinois Foundation, 402 U.S. 313 (1971), 2-34, 5-91, 5-92, 14-25, 14-97
Bloomer v. McQuewan, 55 U.S. 539 (1852), 6-6
BMC Resources, Inc. v. Paymentech, LP, 498 F.3d 1373 (Fed. Cir. 2007), 6-14–6-15, 6-40, 6-41
Body Science Patent Litigation, *In re*, 883 F. Supp. 2d 1344 (2012) (MDL No. 2375), 5-26
Bond, *In re*, 910 F.2d 831 (Fed. Cir. 1990), 6-9
Bonito Boats, Inc. v. Thunder Craft Boats, Inc., 489 U.S. 141 (1989), 11-11
Borden, *In re*, 90 F.3d 1570 (Fed. Cir. 1996), 11-12
Bosch, LLC v. Snap-On Inc., 769 F.3d 1094 (Fed. Cir. 2014), 5-81
Boston Scientific Corp. v. Johnson & Johnson, 2009 U.S. Dist. LEXIS 35372, 2009 WL 975424 (N.D. Cal. Apr. 19, 2009), 9-7
Boston Scientific Corp. v. Lee, No. 5-14-mc-80188-BLF-PSG, 2014 U.S. Dist. LEXIS 107584, 2014 WL 3851157 (N.D. Cal. Aug. 4, 2014), 4-24
Boston Scientific Scimed Inc. v. Cordis Corp., 554 F.3d 982 (Fed. Cir. 2009), 5-42
Bourne v. Jones, 114 F. Supp. 413 (S.D. Fla. 1951), *aff'd*, 207 F.2d 173 (5th Cir. 1953), 12-7
Bowman v. Monsanto, 133 S. Ct. 1761 (2013), 12-11, 14-90
Boyden Power-Brake Co. v. Westinghouse, 170 U.S. 537 (1898), 14-87
BP Amoco Chemical Co. v. Flint Hills Resources, LLC, No. 05 C 5, 2010 WL 1131660 (N.D. Ill. Mar. 25, 2010), 4-41
BP Lubricants USA Inc., *In re*, 637 F.3d 1307 (Fed. Cir. 2011), 14-113
BrainTree Laboratories, Inc. v. Amruthan, Inc., Case No. 11-01854 (E.D. Pa. Feb. 24, 2012), 10-13
Braintree Laboratories, Inc. v. Novel Labs., Inc., 749 F.3d 1349 (Fed. Cir. 2014), 5-73
BRCA1- & BRCA2-Based Hereditary Cancer Test Patent Litig., *In re*, 774 F.3d 755 (Fed. Cir. 2014), 6-31
Brenner v. Manson, 383 U.S. 519 (1966), 14-45, 14-46
Brewer v. Quaker State Oil Refining Corp., 72 F.3d 326 (3d Cir. 1995), 4-37
Bridgestone Ams., Inc. v. Int'l Bus. Machs. Corp., No. 3:13-1196, 2014 U.S. Dist. LEXIS 142525, 2014 WL 4923014 (M.D. Tenn. July 22, 2014), 4-19
Bristol-Myers Squibb Co. v. Ben Venue Labs., Inc., 246 F.3d 1368 (Fed. Cir. 2001), 14-80
Bristol-Myers Squibb Co. v. Rhone-Poulenc Rorer, Inc., 326 F.3d 1226 (Fed. Cir. 2003), 7-53, 8-25
Broadcom Corp. v. Emulex Corp., 732 F.3d 1325 (Fed. Cir. 2013), 9-3
Broadcom Corp. v. Qualcomm Inc., 501 F.3d 297 (3d Cir. 2007), 2-72
Broadcom Corp. v. Qualcomm Inc., 543 F.3d 683 (Fed. Cir. 2008), 9-3, 9-4
Brown v. Chertoff, 563 F. Supp. 2d 1372 (S.D. Ga. 2008), 4-45
Brown v. Tellerate Holdings, No. 2:11-cv-1122, 2014 U.S. Dist. LEXIS 90123, 2014 WL 2987051 (S.D. Ohio July 1, 2014), 4-20, 4-21, 4-22

Patent Case Management Judicial Guide, Third Edition

Brulotte v. Thys Co., 379 U.S. 29 (1964), 14-95, 14-99
Brunswick Corp. v. United States, 46 U.S.P.Q.2d 1446 (Fed. Cir. 1998), 7-34
Buckley v. Airshield Corp., 116 F. Supp. 2d 658 (D. Md. 2000), 7-29
Bud Antle, Inc. v. Scattini Seed Co., No. C-85-20699-WAI, 1985 WL 6440, 1985 U.S. Dist. LEXIS 12587, (N.D. Cal. Dec. 20, 1985), 12-10
Budde v. Harley-Davidson, Inc., 250 F.3d 1369 (Fed. Cir. 2001), 6-35, 6-36
Buildex, Inc. v. Kason Indus., Inc., 849 F.2d 1451 (Fed. Cir. 1988), 8-31
Burkhart v. Wash. Metro. Area Transit Auth., 112 F.3d 1207 (D.C. Cir. 1997), 8-24
Burnet v. Coronado Oil & Gas Co., 285 U.S. 393 (1932), 5-100
Burroughs Wellcome Co. v. Barr Labs., Inc., 40 F.3d 1223 (Fed. Cir. 1994), 14-76
buySAFE, Inc. v. Google, Inc., 765 F.3d 1350 (Fed. Cir. 2014), 2-76, 6-19, 6-30, 6-31
Cadence Pharmaceuticals Inc. v. Exela PharmSci Inc., 780 F.3d 1364 (Fed. Cir. 2015), 14-83
Cadey, *Ex parte*, 1916 Comm'n Dec. 57 (Comm'r Dec. Pat. 1916), 11-5
California Artificial Stone Paving Co. v. Molitor, 113 U.S. 609 (1885), 9-8
California Dental Ass'n v. FTC, 224 F.3d 942 (9th Cir. 2000), 10-21
California Eastern Labs., Inc. v. Gould, 896 F.2d 400 (9th Cir. 1990), 14-91
California Institute of Tech. v. Hughes Commc'ns, Inc., 59 F. Supp. 3d 974 (C.D. Cal. 2014), 6-18, 14-44
California Table Grape Comm'n v. RB Sandrini, Inc., No. 1:06-cv-00842-OWW-TAG, 2007 WL 1847631, 2007 U.S. Dist. LEXIS 48362 (E.D. Cal. June 27, 2007), 12-7
Callicrate v. Wadsworth Mfg., Inc., 427 F.3d 1361 (Fed. Cir. 2005), 5-79, 5-81
Callwave Communications v. Wavemarket Inc., No. 35, C 14-80112 JSW (LB) (N.D. Cal. Aug. 29, 2014), 4-7
Calypso Wireless v. T-Mobile USA Inc., No. 08-cv-00441, 2015 U.S. Dist. LEXIS 26871, 2015 WL 1022745 (E.D. Tex. Mar. 5, 2015), 9-15
Cambrian Science Corp. v. Cox Commc'ns Inc., No. 11-cv-01011, 2015 U.S. Dist. LEXIS 4415, 2015 WL 178417 (C.D. Cal. Jan. 6, 2015), 9-13
Cancer Research Technology Ltd. v. Barr Labs., Inc., 625 F.3d 724 (Fed. Cir. 2010), 14-96
Canton v. Kmart Corp., No. 1:05- CV- 143, 2009 WL 2058908 (D.V.I. July 13, 2009), 4-37
Capon v. Eshhar, 418 F.3d 1349 (Fed. Cir. 2005), 14-48
Capriola Corp. v. La Rose Indus., LLC, 2013 U.S. Dist. LEXIS 65754, 2013 WL 1868344 (M.D. Fla. Mar. 11, 2013), 2-56
Caraco Pharmaceutical Labs. v. Novo Nordisk, 132 S. Ct. 1670 (2012), 10-6, 10-13
Caraco Pharmaceutical Labs., Ltd. v. Forest Labs. Inc., 527 F.3d 1278 (Fed. Cir. 2008), 10-7, 10-12, 10-13, 10-14
Cardiac Pacemakers, Inc. v. Saint Jude Med., Inc., 296 F.3d 1106 (Fed. Cir. 2002), 6-3, 14-88
Cardinal Chemical Co. v. Morton Int'l, Inc., 508 U.S. 83 (1993), 2-34, 5-102, 6-39, 7-43, 9-18
Cardizem CD Antitrust Litigation, *In re*, 332 F.3d 896 (6th Cir. 2003), 10-20
Carl Zeiss Vision Intern. GmbH v. Signet Armorlite, Inc., No. 07CV0894 DMS(POR), 2010 WL 743792 (S.D. Cal. Mar. 1, 2010), 4-43
Carletti, *In re*, 328 F.2d 1020 (C.C.P.A. 1964), 11-3, 11-10
Carman Industries, Inc. v. Wahl, 724 F.2d 932 (Fed. Cir. 1983), 11-4
Carroll Touch, Inc. v. Electro Mech. Systems, Inc., 15 F.3d 1573 (Fed. Cir. 1993), 6-4, 14-99
Catalina Lighting, Inc. v. Lamps Plus, Inc., 295 F.3d 1277 (Fed. Cir. 2002), 11-14

Table of Cases

Catalina Marketing Int'l, Inc. v. Coolsavings.com, Inc., 289 F.3d 801 (Fed. Cir. 2002), 5-71, 5-72, 5-77

CBT Flint Partners, LLC v. Return Path, Inc., 654 F.3d 1353 (Fed. Cir. 2011), 5-83

Celltrion Healthcare Co., Ltd. v. Kennedy Trust for Rheumatology Research, Case No. 14 Civ. 2256 (PAC) (Dkt. No. 32) (S.D.N.Y. Dec. 1, 2014), 10-34

Celsis In Vitro, Inc. v. CellzDirect, Inc., 664 F.3d 922 (Fed. Cir. 2012), 3-11

Cent. Admixture Pharm. Servs. v. Advanced Cardiac Solutions, P.C., 482 F.3d 1347 (Fed. Cir. 2007), 2-45, 5-75

Centillion Data Systems, LLC v. Convergys Corp., No. 104CV0073LJMWTL, 2006 WL 20777, 2006 U.S. Dist. LEXIS 846 (S.D. Ind. Jan. 4, 2006), 4-25

Centillion Data Systems, LLC v. Qwest Commc'ns Int'l, 631 F.3d 1279 (Fed. Cir. 2011), 6-40, 14-79

Centocor Ortho Biotech, Inc. v. Abbott Labs., 636 F.3d 1341 (Fed. Cir. 2011), 14-48

Centricut, LLC v. Esab Grp., Inc., 390 F.3d 1361 (Fed. Cir. 2004), 14-77

Chamberlain Group, Inc. v. Lear Corp., 516 F.3d 1331 (Fed. Cir. 2008), 3-10

Chao Tai Electron Co. Ltd. v. Ledup Enter., Inc., No. 12-10137 (C.D. Cal. Sept. 18, 2014), 9-16

Charles Machine Works, Inc. v. Vermeer Mfg. Co., 723 F.3d 1376 (Fed. Cir. 2013), 6-4

Checkpoint Systems v. All-Tag Sec. S.A., 412 F.3d 1331 (Fed. Cir. 2005), 2-36

Checkpoint Systems v. All-Tag Sec. S.A., 572 F. App'x 988 (Fed. Cir. 2014), 9-14

Checkpoint Systems, Inc. v. U.S. Int'l Trade Comm'n, 54 F.3d 756 (Fed. Cir. 1995), 6-7

Chef America, Inc. v. Lamb-Weston, Inc., 358 F.3d 1371 (Fed. Cir. 2004), 5-83, 5-84

Chemcast Corp. v. Arco Indus. Corp., 913 F.2d 923 (Fed. Cir. 1990), 14-50

Chem-Tainer Indus. v. Wilkin, No. CV 97-0829LGB(EX), 1997 WL 715014, 1997 U.S. Dist. LEXIS 17241 (C.D. Cal. Feb. 24, 1997), 3-20

Chevron U.S.A., Inc. v. Natural Resources Defense Council, Inc., 467 U.S. 837 (1984), 14-11

Chicago Board Options Exch., Inc. v. Int'l Sec. Exch., LLC, 677 F.3d 1361 (Fed. Cir. 2012), 5-66

Chicago Board Options Exch., Inc. v. Int'l Sec. Exch., LLC, 748 F.3d 1134 (Fed. Cir. 2014), 5-82

Chimie v. PPG Indus., Inc., 402 F.3d 1371 (Fed. Cir. 2005), 5-64

Chiron Corp. v. Genentech, Inc., 363 F.3d 1247 (Fed. Cir. 2004), 7-9

Chiuminatta Concrete Concepts, Inc. v. Cardinal Indus., Inc., 145 F.3d 1303 (Fed. Cir. 1998), 14-87

Christianson v. Colt Industries Operating Corp., 486 U.S. 800 (1988), 2-60

Christo v. Padgett, 223 F.3d 1324 (11th Cir. 2002), 5-95

CIAS, Inc. v. Alliance Gaming Corp., 504 F.3d 1356 (Fed. Cir. 2007), 5-75

Cincinnati Car Co. v. New York Rapid Transit Corp., 66 F.2d 592 (2d Cir. 1933), 8-34, 14-106

Cincinnati Siemens-Lungren Gas Illuminating Co. v. Western Siemens-Lungren Co., 152 U.S. 200 (1894), 7-14

Cipro Cases I & II, *In re*, No. S198616, 2015 WL 2125291 (Cal. Sup. Ct. 2015), 10-24

Ciprofloxacin Hydrochloride Antitrust Litig., *In re*, 544 F.3d 1323 (Fed. Cir. 2008), *cert. denied*, 129 S. Ct. 2828 (2009), 10-19, 10-21

Circle R, Inc. v. Smithco Mfg., 919 F. Supp. 1272 (N.D. Iowa 1996), 3-8

Cisco Systems, Inc. v. Innovative Wireless Solutions, LLC, Case 1:13-cv-00492, 2013 WL 3130645 (W.D. Tex. June 12, 2013), 2-34

Cisco Systems, Inc. v. Telcordia Techs., Inc., 590 F. Supp. 2d 828 (E.D. Tex. 2008), 5-101

City of Elizabeth v. Am. Nicholson Pavement Co., 97 U.S. 126 (1877), 14-58

Clay, *In re*, 966 F.2d 656 (Fed. Cir. 1992), 14-68

Patent Case Management Judicial Guide, Third Edition

Clear With Computers, LLC v. Hyundai Motor Am., Inc., 753 F. Supp. 2d 662 (E.D. Tex. 2010), 4-32
Cleversafe, Inc. v. Amplidata, Inc. 2011 U.S. Dist. LEXIS 145995, 2011 WL 6379300 (N.D. Ill. Dec. 20, 2011), 2-44
Clock Spring, L.P. v. Wrapmaster, Inc., 560 F.3d 1317 (Fed. Cir. 2009), 6-7
CLS Bank Int'l v. Alice Corp. Pty. Ltd., 717 F.3d 1269 (Fed. Cir. 2013), 6-19
CLS Bank Int'l v. Alice Corp. Pty. Ltd., 768 F. Supp. 2d 221 (D.D.C. 2011), 6-19
Coast Metals, Inc. v. Cape, 205 U.S.P.Q. 154 (D.N.J. 1979), 14-100
Coastal Dynamics Corp. v. Symbolic Displays, Inc., 469 F.2d 79 (9th Cir. 1972), 14-98
Codex Corp. v. Milgo Elec. Corp., 553 F.2d 735 (1st Cir. 1977), 2-52
Cogent Med., Inc. v. Elsevier Inc., 2014 U.S. Dist. LEXIS 139856, 2014 WL 4966326 (N.D. Cal. 2014), 6-18, 14-44
Cognex Corp. v. Microscan Systems, Inc., No. 13-CV-2027, 2014 U.S. Dist. LEXIS 91203, 2014 WL 2989975 (S.D.N.Y. June 30, 2014), 9-13
Cole v. Kimberly-Clark Corp., 102 F.3d 524 (Fed. Cir. 1996), 5-79, 14-80, 14-81, 14-82
Collectors Universe, Inc. v. Blake, No. 14-cv-333 (C.D. Cal. Mar. 18, 2015), 9-15
Columbia First Bank, FSB v. United States, 54 Fed. Cl. 693 (2002), 4-47
Comaper Corp. v. Antec, Inc., No. 5-cv-1103 (E.D. Pa. July 14, 2014), 9-13
Comark Communications, Inc. v. Harris Corp., 156 F.3d 1182 (Fed. Cir. 1998), 5-62, 5-63
Comiskey, *In re*, 499 F.3d 1365 (Fed. Cir. 2007), 14-40
Committee of the University of Montreal Pension Plan v. Banc of Am. Sec., 685 F. Supp. 2d 456 (S.D.N.Y. 2010), 4-36
Commil USA, LLC v. Cisco Systems, Inc., 720 F.3d 1361 (Fed. Cir. 2013), 7-16, 7-17, 14-78
Commil USA, LLC v. Cisco Systems, Inc., 135 S. Ct. 1920 (2015), 7-17, 8-30, 14-78
Commissariat a l'Energie Atomique v. Chi Mei Optoelectronics Corp., 395 F.3d 1315 (Fed. Cir. 2005), 2-60
Commissariat a l'Energie Atomique v. Dell Comput. Corp., No. Civ.A. 03-484-KAJ, 2004 WL 406351, 2004 U.S. Dist. LEXIS 12782 (D. Del. Mar. 3, 2004), 4-31
Commonwealth Scientific and Industrial Research Organisation v. Cisco Systems, Inc., 809 F.3d 1295 (Fed. Cir. 2015), 8-36, 14-110
Commonwealth Scientific and Industrial Research Organisation (CSIRO) v. Buffalo Technology Inc., 492 F. Supp. 2d 600 (E.D. Tex. 2007), 3-13
Compco Corporation v. Day-Brite Lighting, Inc., 376 U.S. 234 (1964), 14-99
Conoco Inc. v. Energy & Environmental Int'l, 460 F.3d 1349 (Fed. Cir. 2006), 5-41
Conservolite, Inc. v. Widmayer, 21 F.3d 1098 (Fed. Cir. 1994), 14-113
Consolidated Aluminum Corp. v. Foseco Int'l Ltd., 910 F.2d 804 (Fed. Cir. 1990), 14-93
Consolidated Edison Co. of N.Y., Inc. v. United States, 90 Fed. Cl. 228 (Ct. Cl. 2009), 4-47
Constant v. Advanced Micro-Devices, Inc., 848 F.2d 1560 (Fed. Cir. 1988), 14-53
Content Extraction & Transmission LLC v. Wells Fargo Bank, National Ass'n, 776 F.3d 1343 (Fed. Cir. 2014), 6-19, 6-31
Contentguard Holdings, Inc. v. Google, Inc., 2014 U.S. Dist. LEXIS 51676, 2014 WL 1477670 (E.D. Tex. Apr. 15, 2014), 2-73
Contessa Food Products, Inc. v. Conagra, Inc., 282 F.3d 1370 (Fed. Cir. 2002), 11-3
Continental Can Co. USA v. Monsanto Co., 948 F.2d 1264 (Fed. Cir. 1991), 14-52
Convergent Technologies Sec. Litig., *In re*, 108 F.R.D. 328 (N.D. Cal. 1985), 4-7

Table of Cases

Convertible Rowing Exerciser Patent Litigation, *In re*, 903 F.2d 822 (Fed. Cir. 1990), 14-116

Cook Biotech Inc. v. Acell, Inc., 460 F.3d 1365 (Fed. Cir. 2006), 14-82

Cooper Cameron Corp. v. Kvaerner Oilfield Prods., Inc., 291 F.3d 1317 (Fed. Cir. 2002), 14-53

Cooper Technologies Co. v. Dudas, 536 F.3d 1330 (Fed. Cir. 2008), 14-11, 14-24

Cooper v. Goldfarb, 154 F.3d 1321 (Fed. Cir. 1998), 6-7

Cordis Corp. v. Medtronic AVE, Inc., 339 F.3d 1352 (Fed. Cir. 2003), 5-50

Cornell Research Foundation, Inc. v. Hewlett Packard Co., 223 F.R.D. 55 (N.D.N.Y. 2003), 4-27

Cornell University v. Hewlett-Packard Co., 2008 WL 5671886 (N.D.N.Y. 2008), 6-6

Cornell University v. Hewlett-Packard Co., 609 F. Supp. 2d 279 (N.D.N.Y. 2009), 8-36, 14-107

CoStar Realty Information, Inc. v. CIVIX-DDI, LLC, 2013 U.S. Dist. LEXIS 135448, 2013 WL 5346440 (N.D. Ill. 2013), 5-96

Cramp & Sons v. Int'l Curtis Marine Turbine, 246 U.S. 28 (1918), 13-4

Crandall v. City & County of Denver, Colo., No. 05-CV-00242-MSKMEH, 2006 WL 2683754 (D. Colo. Sept. 19, 2006), 4-44

Crater Corp. v. Lucent Techs. Inc., 255 F.3d 1361 (Fed. Cir. 2001), 13-3

CreAgri, Inc. v. Pinnacle, Inc., No. 11-cv-6635, 2014 U.S. Dist. LEXIS 77484, 2014 WL 2508386 (N.D. Cal. June 3, 2014), 9-15

Creative Internet Advert. Corp. v. Yahoo! Inc., 674 F. Supp. 2d 847 (E.D. Tex. 2009), 9-8

Critical-Vac Filtration Corp. v. Minuteman Int'l, Inc., 233 F.3d 697 (2d Cir. 2000), 2-46

Crocs, Inc. v. Int'l Trade Comm'n, 598 F.3d 1294 (Fed. Cir. 2010), 11-8, 11-9, 14-71

Cross Medical Products, Inc. v. Medtronic Sofamor Danek, Inc., 424 F.3d 1293 (Fed. Cir. 2005), 5-71

Crown Die & Tool Co. v. Nye Tool & Mach. Works, 261 U.S. 24 (1923), 2-31

Crown Packaging Technology v. Reexam Beverage Can, Co., 559 F.3d 1308 (Fed. Cir. 2009), 14-111

Croydon Co., Inc. v. Unique Furnishings, Ltd., 831 F. Supp. 480 (E.D.N.C. 1993), 13-5, 13-6

Crozier v. Fried. Krupp Aktiengesellschaft, 224 U.S. 290 (1912), 13-1

Crucible, Inc. v. Stora Kopparbergs Bergslags AB, 594 F. Supp. 1249 (W.D. Pa. 1985), *aff'd in relevant part*, 793 F.2d 1565 (Fed. Cir. 1986), 9-20

Cruciferous Sprout Litigation, *In re*, 301 F.3d 1343 (Fed. Cir. 2004), 5-72

Crystal Semiconductor Corp. v. TriTech Microelectronics Int'l, Inc., 246 F.3d 1336 (Fed. Cir. 2001), 5-74, 14-103, 14-104

Cummins-Allison Corp. v. Glory Ltd., No. 02 C 7008, 2003 WL 26620151, 2003 U.S. Dist. LEXIS 23653 (N.D. Ill. Dec. 31, 2003), 4-30

Cummins-Allison Corp. v. SBM Co., Ltd., 669 F. Supp. 2d 774 (E.D. Tex. 2009), 9-8

Cuno Engineering Corp. v. Automatic Devices Corp., 314 U.S. 84 (1941), 1-8, 14-35, 14-64

Cuozzo Speed Techs., LLC, *In re*, 778 F.3d 1271 (Fed. Cir. 2015), 14-25

Curtiss-Wright Flow Control Corp. v. Velan, Inc., 438 F.3d 1374 (Fed. Cir. 2006), 5-70

Custom Accessories, Inc. v. Jeffrey-Allen Indus., Inc., 807 F.2d 955 (Fed. Cir. 1986), 14-68

CVI/Beta Ventures v. Custom Optical Frames, 859 F. Supp. 945 (D. Md. 1994), 3-20, 3-21

CVI/Beta Ventures, Inc. v. Tura LP, 112 F.3d 1146 (Fed. Cir. 1997), 2-25, 2-26

Cybor Corp. v. FAS Techs., Inc., 138 F.3d 1448 (Fed. Cir. 1998), 2-19, 5-4, 5-76, 5-87, 5-88, 6-4, 6-6, 14-80

CytoLogix Corp. v. Ventana Med. Systems, Inc., 424 F.3d 1168 (Fed. Cir. 2005), 5-10, 5-33, 8-42

D'Onofrio v. SFX Sports Group, Inc., No. 06-687 (JDB/JMF), 2010 WL 3324964 (D.D.C. Aug. 24, 2010), 4-46

Patent Case Management Judicial Guide, Third Edition

Da Silva Moore v. Publicis Groupe, 287 F.R.D. 182 (S.D.N.Y. 2012), 4-19
Dabney v. Montgomery Ward & Co., Inc., 761 F.2d 494 (8th Cir. 1985), 8-42
Dae Kon Kwon v. Costco Wholesale Corp., No. CIV. 08-360 JMSBMK, 2010 WL 571941 (D. Haw. 2010), 4-43
Daiichi Sankyo Co., Ltd. v. Apotex, Inc., 501 F.3d 1254 (Fed. Cir. 2007), 6-8
Daimler AG v. Bauman, 134 S. Ct. 746 (2014), 2-59, 10-10
Dana v. E.S. Originals, Inc., 342 F.3d 1320 (Fed. Cir. 2003), 5-95, 5-102
Dane Industries v. Ameritek Industries, LLC, 154 F. App'x 894 (Fed. Cir. 2005), 2-36
Dane Technologies, Inc. v. Gatekeeper Systems, Inc., 2013 U.S. Dist. LEXIS 117718, 2013 WL 4483355 (D. Minn. Aug. 20, 2013), 2-57
Danisco U.S. Inc. v. Novozymes A/S, 744 F.3d 1325 (Fed. Cir. 2014), 2-32
Data General Corp. v. Johnson, 78 F.3d 1556 (Fed. Cir. 1996), 5-98
Datamize, LLC v. Plumtree Software, Inc., 417 F.3d 1342 (Fed. Cir. 2005), 5-49, 5-86
Datascope Corp. v. SMEC, Inc., 879 F. Supp. 820 (Fed. Cir. 1989), 8-34
Daubert v. Merrell Dow Pharm., Inc., 509 U.S. 579 (1993), 2-112, 7-24, 7-25-7-27, 10-41
Davis v. Wakelee, 156 U.S. 680 (1895), 5-90
Davison Chemical Corp. v. Joliet Chems., Inc., 179 F.2d 793 (7th Cir. 1950), 14-35
DDR Holdings, LLC v. Hotels.com, L.P., 773 F.3d 1245 (Fed. Cir. 2014), 6-18, 6-19, 6-32, 14-44
DeBenedetto v. Goodyear Tire & Rubber Co., 754 F.2d 512 (4th Cir. 1985), 8-20
Decca Ltd. v. United States, 640 F.2d 1156 (Ct. Cl. 1980), 13-1, 13-8
Deepsouth Packing Co. v. Laitram Corp., 406 U.S. 518 (1972), 14-37, 14-88
Deere & Co. v. Bush Hog, LLC, 703 F.3d 1349 (Fed. Cir. 2012), 6-4
Deering Precision Instruments, L.L.C. v. Vector Distrib. Systems, Inc., 347 F.3d 1314 (Fed. Cir. 2003), 5-75
Default Proof Credit Card Systems, Inc. v. Home Depot U.S.A., Inc., 412 F.3d 1291 (Fed. Cir. 2005), 5-85
Delaware Valley Floral Group, Inc. v. Shaw Rose Nets, LLC, 597 F.3d 1374 (Fed. Cir. 2010), 6-7
Delano Farms Co. v. California Table Grape Commission, 778 F.3d 1243 (Fed. Cir. 2015), 12-7
Delta & Pine Land Co. v. The Sinkers Corp., 177 F.3d 1343 (Fed. Cir. 1999), 12-8
Dembiczak, *In re*, 175 F.3d 994 (Fed. Cir. 1999), 6-26, 11-4
Dentsply Int'l, Inc. v. Kerr Mfg. Co., 42 F. Supp. 2d 385 (D. Del. 1999), 3-23
DePuy Spine, Inc. v. Medtronic Sofamor Danek, Inc., 567 F.3d 1314 (Fed. Cir. 2009), 14-72
DePuy Spine, Inc. v. Medtronic Sofamor Danek, Inc., 469 F.3d 1005 (Fed. Cir. 2006), 5-79
Deutsche Bank, *In re*, 605 F.3d 1373 (Fed. Cir. 2010), 4-11, 4-12, 4-31
Dexas International, Ltd. v. Office Max, Inc., 2009 WL 252164, 2009 U.S. Dist. LEXIS 6642 (E.D. Tex. Jan. 30, 2009), 11-9
Dey Pharma, LP v. Sunovion Pharm. Inc., 677 F.3d 1158 (Fed. Cir. 2012), 10-7, 10-14
Diamond Rubber Co. v. Consol. Rubber Tire Co., 220 U.S. 428 (1911), 14-70
Diamond Scientific Co. v. Ambico, Inc., 848 F.2d 1220 (Fed. Cir. 1988), 2-35, 14-98, 14-100
Diamond v. Chakrabarty, 447 U.S. 303 (1980), 6-17, 14-37, 14-38
Diamond v. Diehr, 450 U.S. 175, 184 (1981), 6-17, 14-39
Diamond v. Diehr, 6 No. 79-1112 (June 10, 1980), 14-39
Digital Corp. v. Futurewei Techs., Inc., 772 F.3d 723 (Fed. Cir. 2014), 5-92

Table of Cases

Digital Reg of Texas, LLC v. Adobe Systems, Inc., No. 12-1971, 2015 U.S. Dist. LEXIS 29328, 2015 WL 1026226 (N.D. Cal. Mar. 9, 2015), 9-13

Digitech Image Techs., LLC v. Agfaphoto Holding GmbH, 2012 U.S. Dist. LEXIS 142034, 2012 WL 4513805 (C.D. Cal. Oct. 1, 2012), 2-38

Dillon v. Nissan Motor Co., 986 F.2d 263 (8th Cir. 1993), 4-42

Dimick v. Schiedt, 293 U.S. 474 (1935), 8-3

Dippin' Dots, Inc. v. Mosey, 476 F.3d 1337 (Fed. Cir. 2007), 7-11

Doctor's Assocs., Inc. v. Distajo, 107 F.3d 126 (2d Cir. 1997), 3-26

Document Generation Corp. v. Allscripts, LLC, 2009 WL 1766096, 2009 U.S. Dist. LEXIS 52874 (E.D. Tex. June 23, 2009), 4-12

Doll, *In re*, 419 F.2d 925 (C.C.P.A. 1970), 14-21

Door-Master Corp. v. Yorktowne, Inc., 256 F.3d 1308 (Fed. Cir. 2001), 11-11

Dow Chemical Co. v. Astro-Valcour, Inc., 267 F.3d 1334 (Fed. Cir. 2001), 14-56

Dow Chemical Co. v. Mee Indus., Inc., 341 F.3d 1370 (Fed. Cir. 2003), 8-33, 8-34

Dow Chemical Co. v. Nova Chems. Corp., 803 F.3d 620 (Fed. Cir. 2015), 5-86

Dow Chemical Co. v. United States, 226 F.3d 1334 (Fed. Cir. 2000), 13-8

Dow Jones & Co., Inc. v. Ablaise Ltd., 606 F.3d 1388 (Fed. Cir. 2010), 2-33

Dowagiac Manufacturing Co. v. Minn. Moline Plow Co., 235 U.S. 641 (1915), 8-35

Driggin v. American Sec. Alarm Co., 141 F. Supp. 2d 113 (D. Me. 2000), 4-35

DSC Communications Corp. v. Pulse Commc'ns, Inc., 170 F.3d 1354 (Fed. Cir. 1999), 6-5

DSU Medical Corp. v. JMS Co., 471 F.3d 1293 (Fed. Cir. 2006), 7-16

Dunn v. Truck World, Inc., 929 F.2d 311 (7th Cir. 1991), 9-2

Duquesne Light Co. v. Westinghouse Elec. Corp., 66 F.3d 604 (3d Cir. 1995), 8-10, 8-11

Duramed Pharmaceutical Inc. v. Paddock Labs, Inc., 644 F.3d 1376 (Fed. Cir. 2011), 8-27

Durling v. Spectrum Furniture Co., 101 F.3d 100 (Fed. Cir. 1996), 11-12

Duro-Last, Inc. v. Custom Seal, Inc., 321 F.3d 1098 (Fed. Cir. 2003), 8-41, 9-17

DUSA Pharmaceutical, Inc. v. River's Edge Pharm., No. 06-1843(SRC), 2007 WL 748448, 2007 U.S. Dist. LEXIS 16005 (D.N.J. Mar. 7, 2007), 3-17, 3-18

Dynacore Holdings Corp. v. U.S. Philips Corp., 243 F. Supp. 2d 31 (S.D.N.Y. 2003), 5-91

Dynacore Holdings Corp. v. U.S. Philips Corp., 363 F.3d 1263 (Fed. Cir. 2004), 7-30, 14-77

E.I. du Pont de Nemours & Co. v. Phillips Petroleum Co., 835 F.2d 277 (Fed. Cir. 1987), 3-30, 9-20

Eagle Comtronics, Inc. v. Arrow Commc'n Labs., Inc., 305 F.3d 1303 (Fed. Cir. 2002), 14-83-14-84

Eaton Corp. v. Appliance Valves Corp., 792 F.2d 874 (Fed. Cir. 1986), 7-46

eBay Inc. v. MercExchange, LLC, 547 U.S. 388 (2006), 1-1, 1-9, 2-48, 3-2, 3-3, 3-5, 3-7, 3-8, 3-9, 3-11, 3-12, 3-13, 6-5, 9-2, 9-3, 14-101, 14-102, 14-103

EchoStar Commc'ns Corp., *In re*, 448 F.3d 1294 (Fed. Cir. 2006), 2-43

Ecolab, Inc. v. FMC Corp., 569 F.3d 1335 (Fed. Cir. 2009), 14-72

Ecolab, Inc. v. Paracclipse, Inc., 285 F.3d 1362 (Fed. Cir. 2002), 9-17

Ecix Corp. v. Exabyte Corp., 191 F.R.D. 611 (D. Colo. 2000), 4-28

Edberg v. CPI-The Alternative Supplier, Inc., 156 F. Supp. 2d 190 (D. Conn. 2001), 5-94

Edwards Lifesciences AG v. CoreValve, Inc., 699 F.3d 1305 (Fed. Cir. 2012), 9-3

Edwards Lifesciences LLC v. Cook Inc., 582 F.3d 1322 (Fed. Cir. 2009), 5-61, 5-65, 5-70

Patent Case Management Judicial Guide, Third Edition

- Effexor Antitrust Litigation, *In re*, No. 11-cv-5479 (PGS), 2014 WL 4988410 (D.N.J. Oct. 6, 2014), 10-22, 10-23
- Egyptian Goddess, Inc. v. Swisa, Inc., 543 F.3d 665 (Fed. Cir. 2008) (en banc), 11-7, 11-9, 11-10, 11-13
- Eibel Process Co. v. Minnesota & Ontario Paper Co., 261 U.S. 45 (1923), 14-52, 14-70
- Eisai Co. Ltd. v. Dr. Reddy's Labs., Ltd., 533 F.3d 1353 (Fed. Cir. 2008), 14-73
- Eisai Co. v. Teva Pharms. USA, Inc., Civ. Nos. 05-5727 (HAA)(ES), 07-5489 (HAA)(ES), 2008 WL 1722098, 2008 U.S. Dist. LEXIS 33747 (D.N.J. Mar. 28, 2008), 3-26
- Eiselstein v. Frank, 52 F.3d 1035 (Fed. Cir. 1995), 5-75, 6-5
- Elan Microelectronics Corp. v. Apple, Inc., 2009 U.S. Dist. LEXIS 83715, 2009 WL 2972374 (N.D. Cal. Sept. 14, 2009), 2-40, 2-41
- Elan Pharmaceutical, Inc. v. Mayo Foundation for Med. Educ. and Research, 346 F.3d 1051 (Fed. Cir. 2003), 14-52
- Elbex Video, Ltd. v. Sensormatic Elecs. Corp., 508 F.3d 1366 (Fed. Cir. 2007), 5-58, 5-103
- Electronics for Imaging, Inc. v. Coyle, 394 F.3d 1341 (Fed. Cir. 2005), 2-52
- Electro Scientific Industries v. General Scanning, Inc., 247 F.3d 1341 (Fed. Cir. 2001), 9-10
- Eli Lilly & Co. v. Am. Cyanamid Co., 82 F.3d 1568 (Fed. Cir. 1996), 14-89
- Eli Lilly & Co. v. Barr Labs., Inc., 222 F.3d 973 (Fed. Cir. 2000), 14-52
- Eli Lilly & Co. v. Barr Labs., Inc., 251 F.3d 955 (Fed. Cir. 2001), 14-50, 14-97, 14-98
- Eli Lilly & Co. v. Medtronic, Inc., 872 F.2d 402 (Fed. Cir. 1989), *aff'd*, 496 U.S. 661 (1990), 14-92
- Eli Lilly & Co. v. Medtronic, Inc., 496 U.S. 661 (1990), 10-3, 10-4, 10-5
- Eli Lilly & Co. v. Mylan Pharm., No. 14-cv-00389-SEB-TAB, 2015 WL 1125032 (S.D. Ind. Mar. 12, 2015), 10-11
- Eli Lilly & Co. v. Teva Pharm. USA, 557 F.3d 1346 (Fed. Cir. 2009), 10-5, 10-6, 10-15
- Eli Lilly & Co. v. Teva Pharm. USA, Inc., 2004 U.S. Dist. LEXIS 14724, 2004 WL 1724632 (July 29, 2004), 14-66
- Elite Licensing, Inc. v. Thomas Plastics, Inc., 2003 U.S. Dist. LEXIS 2439, 2003 WL 473669 (S.D.N.Y. 2003), 2-52
- Elizabeth v. Pavement Co., 97 U.S. 126 (1877), 1-7
- Elsner, *In re*, 381 F.3d 1125 (Fed. Cir. 2004), 12-8
- EMC Corp. (*EMC I*), *In re*, 677 F.3d 1351 (Fed. Cir. 2012), 2-37, 2-38, 2-71
- EMC Corp., *In re*, 501 F. App'x 973 (Fed. Cir. 2013), 2-61
- Emerson Electric Co. v. Davoil, Inc., 88 F.3d 1051 (Fed. Cir. 1996), 2-55
- Endo Pharmaceutical Inc. v. Actavis Inc., 2014 U.S. Dist. LEXIS 112642, 2014 WL 3950900 (S.D.N.Y. Aug. 13, 2014), 4-13
- Energizer Holdings, Inc. v. Int'l Trade Comm'n, 435 F.3d 1366 (Fed. Cir. 2006), 5-85
- Enhanced Security Research, LLC, *In re*, 739 F.3d 1347 (Fed. Cir. 2014), 8-27
- Environ Products v. Total Containment, Inc., 41 U.S.P.Q.2d (BNA) 1302 (E.D. Pa. Aug. 21, 1996), 4-30
- Environmental Designs, Ltd. v. Union Oil Co., 713 F.2d 693 (Fed. Cir. 1983), 14-65
- Enzo Biochem, Inc. v. Applera Corp., 599 F.3d 1325 (Fed. Cir. 2010), 5-49, 5-50
- Enzo Biochem, Inc. v. Gen-Probe, Inc., 323 F.3d 956 (Fed. Cir. 2002), 14-48
- Eolas Technologies Inc. v. Adobe Systems Inc., 2010 U.S. Dist. LEXIS 58291, 2010 WL 2026627 (E.D. Tex. May 6, 2010), 2-40
- Eolas Technologies, Inc. v. Adobe Systems, Inc., 2011 U.S. Dist. LEXIS 157891, 2011 WL 11070303 (E.D. Tex. Sept. 23, 2011), 5-89

Table of Cases

- Eon Corp. IP Holding LLC v. Sensus USA Inc., 2013 U.S. Dist. LEXIS 32632, 2013 WL 3982994 (N.D. Cal. Mar. 8, 2013), 2-79
- Eon Corp. IP Holdings LLC v. Cisco Systems Inc., No. 12-cv-1011, 2014 U.S. Dist. LEXIS 101923, 2014 WL 3726170 (N.D. Cal. July 25, 2014), 9-15
- Eon Corp. v. AT&T Mobility LLC, 785 F.3d 616 (Fed. Cir. 2015), 5-82
- Eon-Net, L.P. v. Flagstar Bancorp, Inc., 222 F. App'x 970 (Fed. Cir. 2007), 3-30
- EORHB, Inc. v. HOA Holdings, LLC, C.A. No. 7409-VCL (Del. Ch. Oct. 15, 2012), 4-72
- E-Pass Techs., Inc. v. 3Com Corp., 473 F.3d 1213 (Fed. Cir. 2007), 9-22
- Epcon Gas Systems, Inc. v. Bauer Compressors, Inc., 279 F.3d 1022 (Fed. Cir. 2002), 5-75
- ePlus v. Lawson Software, 760 F.3d 1350 (Fed. Cir. 2014), 2-54, 8-40
- ERBE Elektromedizin GmbH v. Canady Tech. LLC, 629 F.3d 1278 (Fed. Cir. 2010), 5-70
- Erico Int'l Corp. v. Vutec Corp., 516 F.3d 1350 (Fed. Cir. 2008), 3-10
- Ericsson, Inc. v. D-Link Systems, Inc., 773 F.3d 1201 (Fed. Cir. 2014), 5-72, 7-18, 8-33, 8-34, 8-35, 8-37, 8-39, 8-40, 14-107, 14-108, 14-110
- Ethicon Endo-Surgery, Inc. v. U.S. Surgical Corp., 149 F.3d 1309 (Fed. Cir. 1998), 9-21, 14-83
- Ethicon, Inc. v. Quigg, 849 F.2d 1422 (Fed. Cir. 1988), 14-24, 14-25
- Ethicon, Inc. v. U.S. Surgical Corp., 135 F.3d 1456 (Fed. Cir. 1998), 2-30, 6-8, 8-5, 14-76
- Evans v. Eaton, 20 U.S. 356 (1822), 1-6
- Every Penny Counts, Inc. v. American Express Co., 563 F.3d 1378 (Fed. Cir. 2009), 5-10
- Excel Innovations, Inc., *In re*, 502 F.3d 1086 (9th Cir. 2007), 2-47
- Exergen Corp. v. Wal-Mart Stores, Inc., 575 F.3d 1312 (Fed. Cir. 2009), 2-14, 2-44, 2-75, 14-93
- Exxon Research & Eng'g Co. v. United States, 265 F.3d 1371 (Fed. Cir. 2001), 5-50
- Eyickett Corp. v. Unisys Corp., 155 F. Supp. 2d 527 (E.D. Va. 2001), 3-16, 3-22
- F & G Scrolling Mouse L.L.C. v. IBM Corp., 190 F.R.D. 385 (M.D.N.C. 1999), 8-3, 8-7
- Faas v. Sears, Roebuck & Co., 532 F.3d 633 (7th Cir. 2008), 4-41
- Fairchild Semiconductor Corp. v. Third Dimension (3D) Semiconductor, Inc., 564 F. Supp. 2d 63 (D. Me. 2008), 3-19
- Falana v. Kent State Univ., 669 F.3d 1349 (Fed. Cir. 2012), 5-67
- Falcon Industries, Inc. v. R. S. Herbert Co., 128 F. Supp. 204 (E.D.N.Y. 1955), 11-1
- Fantasy Sports Properties v. Sportsline.com, 287 F.3d 1108 (Fed. Cir. 2002), 5-70
- Federal Trade Commission v. Freecom Commc'ns, Inc., 401 F.3d 1192 (10th Cir. 2005), 2-84
- Fenner Investments, Ltd. v. Hewlett-Packard Co., 2010 U.S. Dist. LEXIS 17536, 2010 WL 786606 (E.D. Tex. Feb. 26, 2010), 7-45
- Fenster Family Patent Holdings, Inc. v. Siemens Med. Solutions USA, Inc., 2005 U.S. Dist. LEXIS 20788, 2005 WL 2304190 (D. Del. Sept. 20, 2005), 2-11, 8-29
- Ferag AG v. Quipp Inc., 45 F.3d 1562 (Fed. Cir. 1995), 14-59
- Ferguson Beauregard/Logic Controls, Inc. v. Mega Systems, LLC, 350 F.3d 1327 (Fed. Cir. 2003), 2-44, 7-46
- Ferring B.V. v. Watson Labs., Inc., 764 F.3d 1401 (Fed. Cir. 2014), 10-5, 10-6
- Festo Corp. v. Shoketsu Kinzoku Kabushiki Co., 234 F.3d 558 (Fed. Cir. 2000), 14-83
- Festo Corp. v. Shoketsu Kinzoku Kogyo Kabushiki Co., 535 U.S. 722 (2002), 3-2, 6-38, 14-84
- Festo Corp. v. Shoketsu Kinzoku Kogyo Kabushiki Co., Ltd., 2005 U.S. Dist. LEXIS 11621, 2005 WL 1398528 (D. Mass. June 10, 2005), 14-68

Patent Case Management Judicial Guide, Third Edition

Festo Corp. v. Shoketsu Kinzoku Kogyo Kabushiki Co., Ltd., 344 F.3d 1359 (Fed. Cir. 2003), 6-4, 14-84
Fieldturf, Inc. v. Sw. Recreational Indus. Inc., 357 F.3d 1266 (Fed. Cir. 2004), 2-30
Fiers v. Revel, 984 F.2d 1164 (Fed. Cir. 1993), 14-48
Fine, *In re*, 837 F.2d 1071 (Fed. Cir. 1988), 14-74
Finisar Corp. v. DirecTV Group, Inc., 523 F.3d 1323 (Fed. Cir. 2008), 5-96, 5-98, 5-100, 9-10
Finisar Corp. v. DirecTV Group, 424 F. Supp. 2d 896 (E.D. Tex. 2006), 2-23
Finjan, Inc. v. Secure Computing Corp., 626 F.3d 1197 (Fed. Cir. 2010), 5-30
First Technology Capital, Inc. v. JPMorgan Chase Bank, N.A., 2013 WL 7800409, 2013 U.S. Dist. LEXIS 185763 (E.D. Ky. Dec. 10, 2013), 4-11
Fisher, *In re*, 421 F.3d 1365 (Fed. Cir. 2005), 14-43, 14-46
Florida Prepaid Postsecondary Educ. Expense Bd. v. Coll. Savings Bank, 527 U.S. 627 (1999), 3-2, 14-93
Flury v. Daimler Chrysler Corp., 427 F.3d 939 (11th Cir. 2005), 4-45
FMC Corp. v. United States, 3 F.3d 424 (Fed. Cir. 1993), 14-101
Fogerty v. Fantasy, Inc., 510 U.S. 517 (1994), 8-12
Fonar Corp. v. Gen. Elec. Co., 107 F.3d 1543 (Fed. Cir. 1997), 8-36, 14-106
Forest Group, Inc. v. Bon Tool Co., 590 F.3d 1295 (Fed. Cir. 2009), 14-113
Forest Laboratories, Inc. v. Amneal Pharm., No. CV 14-508-LPS, 2015 WL 880599 (D. Del. Feb. 26, 2015), 10-11
Forest Laboratories, Inc. v. Caraco Pharm. Labs., Ltd., No. 06-CV-13143, 2009 WL 998402 (E.D. Mich. Apr. 14, 2009), 4-40
Forest Laboratories, Inc. v. Ivax Pharm., Inc., 501 F.3d 1263 (Fed. Cir. 2007), 6-27
Forestek Plating & Mfg. Co. v. Knapp-Monarch Co., 106 F.2d 554 (6th Cir. 1939), 11-12
FormFactor, Inc. v. Micronics Japan Co., Ltd., 2008 U.S. Dist. LEXIS 13114, 2008 WL 361128 (N.D. Cal. 2008), 2-49
Fort James Corp. v. Solo Cup Co., 412 F.3d 1340 (Fed. Cir. 2005), 2-33
Fort Properties, Inc. v. Am. Master Lease, LLC, 609 F. Supp. 2d 1052 (C.D. Cal. 2009), *aff'd*, 671 F.3d 1317 (Fed. Cir. 2012), 6-18
Foster, *In re*, 343 F.2d 980 (C.C.P.A. 1965), 14-67
Foster v. Hallco Mfg. Co., 1997 U.S. App. LEXIS 18989, 1997 WL 419391 (Fed. Cir. 1997), 5-76
Francklyn v. Guilford Packing Co., 695 F.2d 1158 (9th Cir. 1983), 14-91
Frazier v. Layne Christensen Co., 239 F. App'x 604 (Fed. Cir. 2007), 7-11
Free Motion Fitness, Inc. v. Cybex Int'l, 423 F.3d 1343 (Fed. Cir. 2005), 5-74
Freedman Seating Co. v. Am. Seating Co., 420 F.3d 1350 (Fed. Cir. 2005), 14-83
Freeman, *In re*, 30 F.3d 1459 (Fed. Cir. 1994), 5-91, 5-92, 5-93
Freeny v. Apple Inc., 2014 U.S. Dist. LEXIS 120446, 2014 WL 4294505 (E.D. Tex. Aug. 28, 2014), 5-49
Freescale Semiconductor, Inc. v. Amtran Tech. Co., 2014 U.S. Dist. LEXIS 58044, 2014 WL 1603665 (W.D. Tex. Mar. 19, 2014), 2-59
Fresenius Medical Care Holdings, Inc. v. Baxter Int'l, Inc., 2006 U.S. Dist. LEXIS 36788, 2006 WL 1469517 (N.D. Cal. May 24, 2006), 5-51
Fresenius Medical Care Holdings, Inc. v. Baxter Int'l, Inc., No. C 03-1431 SBA, 2007 U.S. Dist. LEXIS 44107, 2007 WL 1655625 (N.D. Cal. June 6, 2007), 2-55
Fresenius USA Inc. v. Baxter Int'l Inc., 582 F.3d 1288 (Fed. Cir. 2009), 2-59
Fresenius USA, Inc. v. Baxter Int'l, Inc., 721 F.3d 1330 (Fed. Cir. 2013), 2-54

Table of Cases

Friends for All Children v. Lockheed Aircraft Corp., 587 F. Supp. 180 (D.D.C.), *modified*, 593 F. Supp. 388 (D.D.C.), *aff'd*, 746 F.2d 816 (D.C. Cir. 1984), 4-46

Fromson v. W. Litho Plate & Supply Co., 853 F.2d 1568 (Fed. Cir. 1988), 7-32, 7-35

FTC v. AbbVie Prods., Inc., No. 14-5151 (E.D. Pa. 2014), 10-24

FTC v. Actavis, Inc., 133 S. Ct. 2223 (2013), 10-9, 10-21, 10-22, 10-23, 10-24

FTC v. Brown Shoe Co., 384 U.S. 316 (1966), 10-20

FTC v. Cephalon, Inc., No. 2:08-cv-02141 (E.D. Pa. 2014), 10-24

FTC v. Enforma Natural Products, Inc., 362 F.3d 1204 (9th Cir. 2004), 8-23

FTC v. Watson Pharm., Inc., 677 F.3d 1298 (11th Cir. 2012), 10-21

Fuer Nutzfahrzeuge GmbH v. Dana Corp., 383 F.3d 1337 (Fed. Cir. 2004), 7-33, 7-36

Fuji Photo Film Co. v. Int'l Trade Comm'n, 474 F.3d 1281 (Fed. Cir. 2007), 6-3

Fuji Photo Film Co., Ltd. v. Int'l Trade Comm'n, 386 F.3d 1095 (Fed. Cir. 2004), 5-103

Fujikawa v. Wattanasin, 93 F.3d 1559 (Fed. Cir. 1996), 6-5, 6-7

Fujitsu Ltd. v. Fed. Express Corp., 247 F.3d 423 (2d Cir. 2001), 4-20

Fulda, *Ex parte*, 1913 Comm'n Dec. 206 (Comm'r Dec. Pat. 1913), 11-5

Funai Electric Co., Ltd. v. Daewoo Elecs. Corp., 616 F.3d 1357 (Fed. Cir. 2010), 9-10

Function Media, LLC v. Google, Inc., 708 F.3d 1310 (Fed. Cir. 2013), 5-81, 5-85

Funk Brothers Seed Co. v. Kalo Inoculant Co., 333 U.S. 127 (1948), 14-34, 14-35

Furminator, Inc. v. Ontel Prods. Corp., 246 F.R.D. 579 (E.D. Mo. 2007), 3-22

Futurewei Technologies, Inc. v. Acacia Research Corp., 737 F.3d 704 (Fed. Cir. 2013), 2-52, 2-73

Gaia Technologies, Inc. v. Reconversion Techs., Inc., 104 F.3d 1296 (Fed. Cir. 1996), 2-61

Gambro Lundia AB v. Baxter Healthcare Corp., 110 F.3d 1573 (Fed. Cir. 1997), 6-5, 14-57

Gardco Manufacturing, Inc. v. Herst Lighting Co., 820 F.2d 1209 (Fed. Cir. 1987), 4-28, 7-43, 8-5, 9-12

Gargoyles, Inc. v. United States, 113 F.3d 1572 (Fed. Cir. 1997), 13-8, 13-9

Garmin International, Inc. v. Cuozzo Techs. LLC, Case IPR2012-00001, 2013 Pat. App. LEXIS 2445, 2013 WL 2023626 (P.T.A.B. Mar. 5, 2013), 4-13

Garretson v. Clark, 111 U.S. 120 (1884), 7-21, 8-34, 14-107

Gaus v. Conair Corp., 363 F.3d 1284 (Fed. Cir. 2004), 14-85

Gay, *In re*, 309 F.2d 769 (C.C.P.A. 1962), 14-50

GE Lighting Solutions, LLC v. AgriLight, Inc., 750 F.3d 1304 (Fed. Cir. 2014), 5-60, 5-66, 5-69

Geders v. United States, 425 U.S. 80 (1976), 8-15

Gemmy Industries Corp. v. Chrisha Creations Ltd., 452 F.3d 1353 (Fed. Cir. 2006), 6-7

Gemstar-TV Guide v. Int'l Trade Comm'n, 383 F.3d 1352 (Fed. Cir. 2004), 5-62

Gemtron Corp. v. Saint-Gobain Corp., 572 F.3d 1371 (Fed. Cir. 2009), 5-51

General Atomics v. Axis-Shield ASA, No. C 05-04074 SI, 2006 WL 2329464, 2006 U.S. Dist. LEXIS 58939 (N.D. Cal. Aug. 9, 2006), 2-42

General Electric Co. v. Industra Prods., Inc., 683 F. Supp. 1254 (N.D. Ind. 1988), 4-30

General Electric Co. v. Joiner, 522 U.S. 136 (1997), 6-81

General Mills, Inc. v. Hunt-Wesson, Inc., 103 F.3d 978 (Fed. Cir. 1997), 2-24

General Motors Corp. v. Devex Corp., 461 U.S. 648 (1983), 14-112

General Signal Corp. v. MCI Telecomms. Corp., 66 F.3d 1500 (9th Cir. 1995), 8-12

Genal Strap, Inc. v. Dar, No. CV2004-1691(SJ) (MDG), 2006 WL 525794, 2006 U.S. Dist. LEXIS 11474 (E.D.N.Y. Mar. 3, 2006), 4-29

Patent Case Management Judicial Guide, Third Edition

- Genecorp, Inc. v. Progeny Advanced Genetics, Inc., No. C 97-20706 RMW, 1998 WL 1108155, 1998 U.S. Dist. LEXIS 21910 (N.D. Cal. Apr. 14, 1998), 12-10
- Genentech, Inc. v. Amgen, Inc., 289 F.3d 761 (Fed. Cir. 2002), 2-15
- Genentech, Inc. v. Eli Lilly & Co., 998 F.2d 931 (Fed. Cir. 1993), 2-51, 2-52
- Genentech, Inc. v. Insmed Inc., 442 F. Supp. 2d 838 (N.D. Cal. 2006), 2-43
- Genentech, Inc. v. Novo Nordisk A/S, 108 F.3d 1361 (Fed. Cir. 1997), 3-29
- Genentech, Inc., *In re*, 566 F.3d 1338 (Fed. Cir. 2009), 2-63, 2-64, 2-65
- Genesee Chief v. Fitzhugh, 53 U.S. 443 (1851), 5-100
- Gen-Probe Inc. v. Vysis, Inc., 359 F.3d 1376 (Fed. Cir. 2004), 2-36,
- Georgia-Pacific Corp. v. U.S. Gypsum Co., 195 F.3d 1322 (Fed. Cir. 1999), 6-4
- Georgia-Pacific Corp. v. United States Plywood Corp., 318 F. Supp. 1116 (S.D.N.Y. 1970), 4-31, 7-18, 7-20, 7-32, 7-33, 7-34, 8-35, 8-37, 14-105, 14-106
- Gerber Garment Tech., Inc. v. Letra Systems, 916 F.2d 683 (Fed. Cir. 1990), 14-97
- Giese v. Pierce Chem. Co., 29 F. Supp. 2d 33 (D. Mass. 1998), 2-36
- Gilead Sciences, Inc. v. Natco Pharma Ltd., 753 F.3d 1208 (Fed. Cir. 2014), 14-98
- Gindes v. United States, 740 F.2d 947 (Fed. Cir. 1984), 9-21
- Ginzburg, *Ex parte*, 1925 Comm'n Dec. 159 (Comm'r Dec. Pat. 1925), 11-5
- Gladish v. Tyco Toys, No. S-92-1666 WBS, 1993 U.S. Dist. LEXIS 20211, 1993 WL 625509 (E.D. Cal. 1993), 2-55
- Glasstech Inc. v. AB Kyro O.Y., 635 F. Supp. 465 (N.D. Ohio 1986), 2-50
- Glavas, *In re*, 230 F.2d 447 (C.C.P.A. 1956), 11-11, 11-12
- Glaxo Group Ltd. v. Apotex, Inc., 376 F.3d 1339 (Fed. Cir. 2004), 8-31, 10-5
- Glaxo Group Ltd. v. Ranbaxy Pharm., Inc., 262 F.3d 1333 (Fed. Cir. 2001), 5-38, 5-51
- Glaxo, Inc. v. Novopharm, Ltd., 110 F.3d 1562 (Fed. Cir. 1997), 10-6
- Global Sessions LP v. Comerica Bank, 2014 U.S. Dist. LEXIS 125271, 2014 WL 4415996 (W.D. Tex. 2014), 5-97
- Global Sessions LP v. Travelocity.com, LP *et al.*, 2011 U.S. Dist. LEXIS 155901 (E.D. Tex. Aug. 18, 2011), 2-25, 2-74
- Global Technovations, Inc., *In re*, 431 B.R. 739 (Bankr. E.D. Mich. 2010), 4-40
- Global-Tech Appliances, Inc. v. SEB S.A., 131 S. Ct. 2060 (2011), 6-41, 7-16, 8-30, 14-78
- Globetrotter Software, Inc. v. Elan Computer Group, Inc., 362 F.3d 1367 (Fed. Cir. 2004), 2-58
- Goeddel v. Sugano, 617 F.3d 1350 (Fed. Cir. 2010), 14-47
- Golden Bridge Technology Inc. v. Apple, Inc., 2014 U.S. Dist. LEXIS 67238, 2014 WL 1928977 (N.D. Cal. May 14, 2014), 2-78
- Golden Bridge Technology Inc. v. Apple, Inc., 2014 U.S. Dist. LEXIS 76339, 2014 WL 4057187 (N.D. Cal. June 1, 2014), 2-78
- Golight, Inc. v. Wal-Mart Stores, Inc., 355 F.3d 1327 (Fed. Cir. 2004), 5-68
- Goodman v. Praxair Servs., Inc., 632 F. Supp. 2d 494 (D. Md. 2009), 4-38
- Goodyear Dunlop Tires Operations, S.A. v. Brown, 131 S. Ct. 2846 (2011), 2-59
- Goodyear Tire & Rubber Co. v. Hercules Tire & Rubber Co., Inc., 162 F.3d 1113 (Fed. Cir. 1998), 11-9
- Google, Inc., 2015-138 (Fed. Cir. 2015), 2-61
- Gorham Co. v. White, 81 U.S. 511 (1871), 11-7
- Gottschalk v. Benson, 409 U.S. 63 (1972), 14-36, 14-39

Table of Cases

GPNE Corp. v. Apple, Inc., ECF No. 319 at 2:17-24, No. 5:12-cv-02885-LHK (N.D. Cal. June 24, 2014), 7-57

Grable & Sons Metal Prods., Inc. v. Darue Eng'g & Mfg., 545 U.S. 308 (2005), 2-46

Graco Children's Prods., Inc. v. Regalo Int'l, 77 F. Supp. 2d 660 (E.D. Pa. 1999), 5-94, 5-96

Graff, *In re*, 111 F.3d 874 (Fed. Cir. 1997), 14-21

GrafTech Int'l Holdings Inc. v. G&CS Co., No. 2:12-cv-720, ECF No. 39 (E.D. Tex. Apr. 8, 2014), 2-60

Graham v. John Deere Co. of Kan. City, 383 U.S. 1 (1966), 1-2, 5-92, 6-8, 6-32, 8-32, 12-8, 14-64, 14-70

Graham, *In re*, 973 F.2d 1089 (3d Cir. 1992), 5-95

Granny Goose Foods, Inc. v. Bhd. of Teamsters Local 70, 415 U.S. 423 (1974), 3-19

Graver Tank & Mfg. Co. v. Linde Air Prods. Co., 339 U.S. 605 (1950), 14-82, 14-88

Great Atlantic & Pacific Tea Co. v. Supermarket Equip. Corp., 340 U.S. 147 (1950), 1-8, 14-64

Great-West Life & Annuity Ins. Co. v. Am. Econ. Ins. Co., 2013 WL 5332410, 2013 U.S. Dist. LEXIS 135750 (D. Nev. Sept. 23, 2013), 4-11

Greenberg v. Ethicon Endo-Surgery, Inc., 91 F.3d 1580 (Fed. Cir. 1996), 5-79, 14-81

Griffith v. Kanamaru, 816 F.2d 624 (Fed. Cir. 1987), 14-56

Group One, Ltd. v. Hallmark Cards, Inc., 407 F.3d 1297 (Fed. Cir. 2005), 5-83, 5-84, 5-86

Groupon, Inc. v. MobGob LLC, 2011 U.S. Dist. LEXIS 56937, 2011 WL 2111986 (N.D. Ill. May 25, 2011), 2-44

Guardian Media Techs., Ltd. v. Acer Am. Corp., 2013 U.S. Dist. LEXIS 63044, 2013 WL 1866901 (E.D. Tex. 2013), 5-95

Gulf Oil Corp. v. Gilbert, 330 U.S. 501 (1947), 2-61

Gunn v. Minton, 133 S. Ct. 1059 (2013), 2-46

Guttman, Inc. v. Kopykake Enters., 302 F.3d 1352 (Fed. Cir. 2002), 3-7, 3-10, 5-94, 9-22

Gyromat Corp. v. Champion Spark Plug Co., 735 F.2d 549 (Fed. Cir. 1984), 14-112

H.H. Robertson Co., Cupples Prods. Div. v. V.S. DiCarlo Gen. Contractors, Inc., 950 F.2d 572 (8th Cir. 1991), 8-17

H.H. Robertson, Co. v. United Steel Deck, Inc., 820 F.2d 384 (Fed. Cir. 1987), 3-16

Hahn v. Wong, 892 F.2d 1028 (Fed. Cir. 1989), 14-55

Hakim v. Cannon Avent Group, PLC, 479 F.3d 1313 (Fed. Cir. 2007), 5-38

Hall, *In re*, 781 F.2d 897 (Fed. Cir. 1986), 14-53, 14-54

Halliburton Energy Servs., Inc. v. M-I LLC, 514 F.3d 1244 (Fed. Cir. 2008), 5-49, 5-86

Halliburton Oil Well Cementing Co. v. Walker, 329 U.S. 1 (1946), 14-80, 14-81

Halo Electronics, Inc. v. Pulse Electronics, Inc., 579 U.S. ____ (2016), 2-43, 2-75, 3-6, 6-9, 6-45, 7-14, 7-15, 8-6, 9-9, 14-111-14-112

Hamilton Beach Brands v. Sunbeam Prods., Inc., 726 F.3d 1370 (Fed. Cir. 2013), 14-59

Handgards, Inc. v. Ethicon, Inc., 601 F.2d 986 (9th Cir. 1979), 2-46, 14-100

Hanson v. Alpine Valley Ski Area, Inc., 718 F.2d 1075 (Fed. Cir. 1983), 7-34, 7-35, 14-111

Harari v. Lee, 656 F.3d 1331 (Fed. Cir. 2011), 5-73

Harris Corp. v. Ericsson, 417 F.3d 1241 (Fed. Cir. 2005), 5-97

Hartley v. Mentor Corp., 869 F.2d 1469 (Fed. Cir. 1989), 5-92, 5-96

Hartness International, Inc. v. Simplimatic Eng'g Co., 819 F.2d 1100 (Fed. Cir. 1987), 6-6

Hartranft v. Wiegmann, 121 U.S. 609 (1887), 14-37

Hatfield v. Wal-Mart Stores, Inc., 335 F. App'x 796 (10th Cir. 2009), 4-44

Patent Case Management Judicial Guide, Third Edition

Hayes Microcomputer Products, *In re*, 982 F.2d 1527 (Fed. Cir. 1992), 6-5
Haynes v. Dart, No. 08 C 4834, 2010 WL 140387 (N.D. Ill. Jan. 11, 2010), 4-41
Hazel-Atlas Glass Co. v. Hartford-Empire Co., 322 U.S. 238 (1944), 1-8
Hazelquist v. Guchi Moochie Tackle Co., 437 F.3d 1178 (Fed. Cir. 2006), 2-47
Hearing Components, Inc. v. Shure Inc., 600 F.3d 1357 (Fed. Cir. 2010), 14-75
Hearing Components, Inc. v. Shure, Inc., 2008 U.S. Dist. LEXIS 109230, 2008 WL 2485426 (E.D. Tex. June 13, 2008), 2-11
Heart Seed Co. v. Seeds, Inc., No. C-84-336-SPM, 1987 WL 41982, 1987 U.S. Dist. LEXIS 13969 (E.D. Wash. Jan. 29, 1987), 12-10
Hechinger Investment Co. of Delaware, Inc., *In re*, 489 F.3d 568 (3d Cir. 2007), 4-37
Helman v. Murry's Steaks, Inc., 728 F. Supp. 1099 (D. Del. 1990), 4-11
Helmsderfer v. Bobrick Washroom Equip., Inc., 527 F.3d 1379 (Fed. Cir. 2008), 5-60
Henry Hanger & Display Fixture Corp. of Am. v. Sel-O-Rak Corp., 270 F.2d 635 (5th Cir. 1959), 11-14
Henry v. Gill Indus., 983 F.2d 943 (9th Cir. 1993), 4-43
Hess v. Adv. Cardiovascular Systems, Inc., 106 F.3d 976 (Fed. Cir. 1997), 6-8
Hewlett-Packard Co. v. Acceleron LLC, 587 F.3d 1358 (Fed. Cir. 2009), 2-33
Hewlett-Packard Co. v. Bausch & Lomb, Inc., 882 F.2d 1556 (Fed. Cir. 1989), 14-20
Hewlett-Packard Co. v. Bausch & Lomb, Inc., 909 F.2d 1464 (Fed. Cir. 1990), 5-52
Hewlett-Packard Co. v. Repeat-O-Type Stencil Mfg. Co., 123 F.3d 1445 (Fed. Cir. 1997), 14-90
Hickman v. Taylor, 329 U.S. 495 (1947), 2-43
High Point Design LLC v. Buyers Direct, Inc., 730 F.3d 1301 (Fed. Cir. 2013), 11-12
High Tech Medical Instrumentation, Inc. v. New Image Indus., Inc., 49 F.3d 1551 (Fed. Cir. 1995), 3-12, 3-13
Highmark Inc. v. Allcare Health Management System, Inc., 134 S. Ct. 1744 (2014), 1-2, 9-12, 14-112
Hilgraeve, Inc. v. Symantec Corp., 272 F. Supp. 2d 613 (E.D. Mich. 2003), 8-40
Hilleby v. FMC Corp., No. C-91-0568 FMS (CW), 1992 U.S. Dist. LEXIS 20835, 1992 WL 455436 (N.D. Cal. May 13, 1992), 8-8
Hill-Rom Services, Inc. v. Stryker Corp., 755 F.3d 1367 (Fed. Cir. 2014), 5-38, 5-42, 5-64
Hilton v. Braunskill, 481 U.S. 770 (1987), 3-30
Hirst v. Gertzen, 676 F.2d 1252 (9th Cir. 1982), 8-4
Hoechst Celanese Corp. v. BP Chems. Ltd., 78 F.3d 1575 (Fed. Cir. 1996), 3-17
Hoffer v. Microsoft Corp., 405 F.3d 1326 (Fed. Cir. 2005), 5-76, 5-84
Hoffman v. Blaski, 363 U.S. 335 (1960), 2-61
Hoffmann-La Roche Inc., *In re*, 587 F.3d 1333 (Fed. Cir. 2009), 2-64
Holmes Group, Inc. v. Vornado Air Circulation Systems, Inc., 535 U.S. 826 (2002), 2-60, 14-116
Hologic, Inc. v. SenoRx, 639 F.3d 1329 (Fed. Cir. 2011), 5-67
Home Diagnostics Inc. v. Lifescan, Inc., 120 F. Supp. 2d 864 (N.D. Cal. 2000), 5-93
Home Gambling Network Inc. v. Piche, No. 05-cv-610, 2014 U.S. Dist. LEXIS 71071, 2014 WL 2170600 (D. Nev. May 21, 2014), 9-13
Homeland Housewares, LLC v. Sorensen Research & Dev. Tr., 581 F. App'x 877 (Fed. Cir. 2014), 9-12, 9-16
Honeywell Int'l Inc. v. Hamilton Sundstrand Corp., 370 F.3d 1131 (Fed. Cir. 2004), 8-40, 9-17
Honeywell Int'l, Inc. v. ITC, 341 F.3d 1332 (Fed. Cir. 2003), 5-86

Table of Cases

Honeywell Int'l, Inc. v. ITT Indus., Inc., 452 F.3d 1312 (Fed. Cir. 2006), 5-64, 5-65
Honeywell Int'l, Inc. v. Universal Avionics Systems Corp., 397 F. Supp. 2d 537 (D. Del. 2005), 3-30
Hoop v. Hoop, 279 F.3d 1004 (Fed. Cir. 2002), 11-3
Hormone Research Foundation v. Genentech, Inc., 904 F.2d 1558 (Fed. Cir. 1990), 5-70
Horseshoe Entertainment, *In re*, 337 F.3d 429 (5th Cir. 2003), 2-62
Hospira, Inc. v. Janssen Biotech, Inc., Case No. 14 Civ. 7049 (PAC) (S.D.N.Y. Dec. 1, 2014) (Dkt. No. 60), 10-34
Hotchkiss v. Greenwood, 52 U.S. 248 (1850), 1-7, 14-63, 14-64
Housing Rights Center v. Sterling, 2005 WL 3320739 (C.D. Cal. Mar. 2, 2005), 4-43
Hruby, *In re*, 373 F.2d 997 (C.C.P.A. 1967), 11-3
Humble Oil & Refining Co. v. Bell Marine Serv., Inc., 321 F.2d 53 (5th Cir. 1963), 2-62
H-W Technology, L.C. v. Overstock.com, Inc., 758 F.3d 1329 (Fed. Cir. 2014), 5-41
Hyatt v. Kappos, 132 S. Ct. 1690 (2012), 14-114
Hybritech Inc. v. Abbott Labs., 849 F.2d 1446 (Fed. Cir. 1988), 3-7, 3-9, 3-15
Hybritech Inc. v. Monoclonal Antibodies, Inc., 802 F.2d 1367 (Fed. Cir. 1986), 14-49, 14-70
Hydranautics v. FilmTec Corp., 70 F.3d 533 (9th Cir. 1995), 2-46
Hygh v. Jacobs, 961 F.2d 359 (2d Cir. 1992), 7-28
Hynix Semiconductor Inc. v. Rambus Inc., 645 F.3d 1336 (Fed. Cir. 2011), 4-20, 5-37
I/P Engine, Inc. v. AOL, Inc., 576 F. App'x 982 (Fed. Cir. 2014), 7-11
i4i Limited Partnership v. Microsoft Corp., 589 F.3d 1246 (Fed. Cir. 2009), 5-65
i4i Limited Partnership v. Microsoft Corp., 598 F.3d 831 (Fed. Cir. 2010), *aff'd*, 131 S. Ct. 2238 (2011), 8-41, 9-3, 9-10
Ibormeith IP, LLC v. Mercedes-Benz USA, LLC, 732 F.3d 1376 (Fed. Cir. 2013), 5-85
Icon Health & Fitness, Inc., *In re*, 469 F.3d 1374 (Fed. Cir. 2007), 7-11, 14-72
ICU Medical Inc. v. Alaris Medical Systems Inc., 558 F.3d 1368 (Fed. Cir. 2009), 5-67, 5-70
Idle Free Systems, Inc. v. Bergstrom Inc., IPR 2012-00027, Paper No. 66 (P.T.A.B. Jan. 7, 2014), 4-13
ILJIN U.S.A. v. NTN Corp. 2006 U.S. Dist. LEXIS 15389, 2006 WL 568351 (E.D. Mich. 2006), 2-49
Illinois Tool Works, Inc. v. Grip-Pak, Inc., 906 F.2d 679 (Fed. Cir. 1990), 3-9, 3-14-3-15
Imageexpo, L.L.C. v. Microsoft Corp., 284 F. Supp. 2d 365 (E.D. Va. 2003), 8-40
IMAX Corp. v. In-Three, Inc., 385 F. Supp. 2d 1030 (C.D. Cal. 2005), 2-55
Imazio Nursery Inc. v. Dania Greenhouses, 69 F.3d 1560 (Fed. Cir. 1995), 12-6, 12-7
Impax Laboratories, Inc. v. Aventis Pharm. Inc., 468 F.3d 1366 (Fed. Cir. 2006), 14-52
Imperial Chemical Indus., PLC v. Danbury Pharmacal, Inc., 777 F. Supp. 330 (D. Del. 1991), 14-66
IMX, Inc. v. Lendingtree, LLC, 79 U.S.P.Q.2d 1373, 2005 U.S. Dist. LEXIS 33179, 2005 WL 3465555 (D. Del. Dec. 14, 2005), 14-111
In re (see name of party)
In-Tech Marketing Inc. v. Hasbro, Inc., 685 F. Supp. 436 (D.N.J. 1988), 2-39
Inamed Corp. v. Kuzmak, 249 F.3d 1356 (Fed. Cir. 2001), 2-59
Independent Service Organizations Antitrust Litigation, *In re*, 203 F.3d 1322 (Fed. Cir. 2000), 14-100
Independent Wireless Tel. Co. v. Radio Corp. of Am., 269 U.S. 459 (1926), 2-31, 2-39
Industrial Technical Research Institute v. Int'l Trade Comm'n, 567 F. App'x 914 (Fed. Cir. 2014), 5-40
Info-Hold, Inc. v. Muzak LLC, 783 F.3d 1365 (Fed. Cir. 2015), 8-33

Patent Case Management Judicial Guide, Third Edition

Informatica Corp. v. Business Objects Data Integration, Inc., No. C 02-3378 JSW, 2006 U.S. Dist. LEXIS 58976, 2006 WL 2329460 (N.D. Cal. Aug. 9, 2006), 2-43

Innogenetics, N.V. v. Abbott Labs., 512 F.3d 1363 (Fed. Cir. 2008), 9-4

Innotron Diagnostics, *In re*, 800 F.2d 1077 (Fed. Cir. 1986), 4-28, 8-8

Innovad Inc. v. Microsoft Corp., 260 F.3d 1326 (Fed. Cir. 2001), 5-91

Innovatio IP Ventures LLC Patent Litigation, *In re*, No. 11 C 9308, 2013 U.S. Dist. LEXIS 144061, 2013 WL 5593609 (N.D. Ill. Oct. 3, 2013), 8-39, 14-110

Innovatio IP Ventures, LLC Patent Litigation, *In re*, 956 F. Supp. 2d 925 (N.D. Ill. 2013), 8-7

Innovative Automation LLC v. Kaleidescape, Inc., No. 3:13-CV-05651 (N.D. Cal. Oct. 17, 2014), 4-10

Intamin Ltd. v. Magnetar Techs. Corp., 483 F.3d 1328 (Fed. Cir. 2007), 4-25

Integrated Technology Corp. v. Rudolph Tech., Inc., No. 06-cv-2182 (D. Ariz. Aug. 8, 2014), 9-13

Intel Corp. v. U.S. Int'l Trade Comm'n, 946 F.2d 821 (Fed. Cir. 1991), 2-35, 2-36

Intel Corp. v. ULSI Systems Tech., Inc., 995 F.2d 1566 (Fed. Cir. 1993), 3-5, 14-101

Intellect Wireless, Inc. v. HTC Corp., No. 09-C-2495, 2015 U.S. Dist. LEXIS 2864, 2015 WL 136142 (N.D. Ill. Jan. 8, 2015), 9-13

Intellectual Property Development, Inc. v. TCI Cablevision of Cal., Inc., 248 F.3d 1333 (Fed. Cir. 2001), 2-30, 2-31

Intellectual Ventures I LLC v. Symantec, 2015 U.S. Dist. LEXIS 2841, 2015 WL 82052 (D. Del. Jan. 6, 2015), 7-54, 7-57

Intellectual Ventures I LLC v. Xilinx, Inc., 2014 U.S. Dist. LEXIS 54900, 2014 WL 1573542 (D. Del. Apr. 21, 2014), 2-77

Intellectual Ventures II LLC v. JPMorgan Chase & Co., 781 F.3d 1372 (Fed. Cir. 2015), 2-58

Interdigital Communications, Inc. v. Nokia Corp., 2014 U.S. Dist. LEXIS 182856, 2014 WL 8104167 (D. Del. Sept. 19, 2014), 7-54

International Flavors & Fragrances, Inc. v. U.S. Agriculture, IPR2013-00124 (P.T.A.B. May 20, 2014), 4-13

International Game Technology v. WMS Gaming Inc., No. 98-1361, 1999 U.S. App. LEXIS 22971217 F.3d 850 (Fed. Cir. Sept. 3, 1999), 3-26

International Seaway Trading Corp. v. Walgreens Corp., 589 F.3d 1233 (Fed. Cir. 2009), 11-3, 11-11

Intertool, Ltd. v. Texar Corp., 369 F.3d 1289 (Fed. Cir. 2004), 5-72

Interval Licensing LLC v. AOL, Inc., 2011 U.S. Dist. LEXIS 51195, 2011 WL 1655713 (W.D. Wash. Apr. 29, 2011), 2-37

Interval Licensing LLC v. AOL, Inc., 766 F.3d 1364 (Fed. Cir. 2014), 5-41, 5-49, 5-86, 14-51

Interval Licensing LLC v. AOL, Inc., No. 2010 U.S. Dist. LEXIS 131081, 2010 WL 5058620 (W.D. Wash. Dec. 10, 2010), 2-41

Intex Recreation Corp. v. Team Worldwide Corp., No. 04-cv-01785, 2015 U.S. Dist. LEXIS 2847, 2015 WL 135532 (D.D.C. Jan. 9, 2015), 9-13

Inventio AG v. ThyssenKrupp Elevator Americas Corp., 649 F.3d 1350 (Fed. Cir. 2011), 5-80

Invitrogen Corp. v. Clontech Labs., Inc., 429 F.3d 1052 (Fed. Cir. 2005), 5-38

IP Innovation L.L.C. v. Red Hat, Inc., Case No. 2:07-cv-447 (RRR), 705 F. Supp. 2d 687 (E.D. Tex. 2010), 4-32

IPVX Patent Holdings, Inc. v. Voxernet LLC, No. 13-cv-1708, 2014 U.S. Dist. LEXIS 158037, 2014 WL 5795545 (N.D. Cal. Nov. 6, 2014), 9-13

IPXL Holdings, L.L.C. v. Amazon.com, Inc., 430 F.3d 1377 (Fed. Cir. 2005), 5-86

IRIS Corp. v. Japan Airlines Corp., 769 F.3d 1359 (Fed. Cir. 2014), 13-6

Table of Cases

Irving Air Chute Co. v. United States, 93 F. Supp. 633 (Ct. Cl. 1950), 13-1

J. McIntyre Machinery Ltd. v. Nicastro, 131 S. Ct. 2780 (2011), 2-59

J.E.M. Ag Supply, Inc. v. Pioneer Hi-Bred Int'l, Inc., 534 U.S. 124 (2001), 12-3, 12-6

Jackson Jordan, Inc. v. Plasser Am. Corp., 747 F.2d 1567 (Fed. Cir. 1984), 5-96

Jaffe, *Ex parte*, 147 U.S.P.Q. 45 (PTO Bd. App. 1964), 11-3

Jain v. Memphis Shelby Airport Auth., No. 08-2119-STA-dkv, 2010 WL 711328 (W.D. Tenn. Feb. 25, 2010), 4-40

Jamesbury Corp. v. Litton Indus. Prods. Inc., 756 F.2d 1556 (Fed. Cir. 1985), 6-26-6-27

Janssen Pharmaceutica, NV v. Apotex, Inc., 540 F.3d 1353 (Fed. Cir. 2008), 10-14

Jazz Photo Corp. v. International Trade Commission, 264 F.3d 1094 (Fed. Cir. 2001), 14-90

JDS Uniphase Corp. v. Co-Adna Photonics, Inc., 2014 U.S. Dist. LEXIS 88031, 2014 WL 2918544 (N.D. Cal. June 26, 2014), 2-41

Jervis B. Webb Co. v. S. Systems, Inc., 742 F.2d 1388 (Fed. Cir. 1984), 14-29

Joao Control and Monitoring Systems, LLC v. Ford Motor Co., Nos. 13-CV-13615, 13-CV-13957, 2014 U.S. Dist. LEXIS 2966, 2014 WL 106926 (E.D. Mich. Jan. 10, 2014), 5-11

Joblove v. Barr Labs, Inc., 429 F.3d 370 (2d Cir. 2005), 2-91

Johns Hopkins Univ. v. CellPro, 160 F.R.D. 30 (D. Del. 1995), 8-3

Johnson & Johnston Assocs. Inc. v. R.E. Serv. Co., 285 F.3d 1046 (Fed. Cir. 2002), 6-4, 14-86

Jones v. Bremen High Sch. Dist. 228, No. 08-C-3548, 2010 WL 2106640 (N.D. Ill. May 25, 2010), 4-41

Jordan F. Miller Corp. v. Mid-Continent Aircraft Serv., 139 F.3d 912, 1998 WL 68879 (10th Cir. 1998), 4-44

Joy Technologies, Inc. v. Flakt, Inc., 6 F.3d 770 (Fed. Cir. 1993), 2-37

Joy Technologies, Inc. v. Flakt, Inc., 722 F. Supp. 842 (D. Del. 1991), 4-32

Joyal Products v. Johnson Elec. North Am., Inc., 2009 U.S. Dist. LEXIS 15531, 2009 WL 512156 (D.N.J. Feb. 26, 2009), 9-8

Judin v. United States, 110 F.3d 780 (Fed. Cir. 1997), 2-58

Juicy Whip, Inc. v. Orange Bang, Inc., 185 F.3d 1364 (Fed. Cir. 1999), 6-5

Juicy Whip, Inc. v. Orange Bang, Inc., 292 F.3d 728 (Fed. Cir. 2002), 14-46

Juniper Networks Inc. v. Bahattab, 2009 U.S. Dist. LEXIS 129765, No. 07cv1771 (PLF) (AK) (D.D.C. Aug. 14, 2009), 2-33

Jurgens v. CBK, Ltd., 80 F.3d 1566 (Fed. Cir. 1996), 9-10

Jurgens v. McKasy, 927 F.2d 1552 (Fed. Cir. 1991), 9-17

JVW Enterprises, Inc. v. Interact Accessories, Inc., 424 F.3d 1324 (Fed. Cir. 2005), 5-80

K-Dur Antitrust Litigation, *In re*, 686 F.3d 197 (3d Cir. 2012), 10-20, 10-23

K-Tech Telecomms., Inc. v. Time Warner Cable, Inc., 714 F.3d 1277 (Fed. Cir. 2013), 2-40

Kahn v. Gen. Motors Corp., 889 F.2d 1078 (Fed. Cir. 1989), 2-52

Kaiser Foundation Health Plan Inc. v. Abbott Labs., Inc., 552 F.3d 1033 (9th Cir. 2009), 10-21

Karnazes v. County of San Mateo, No. 09-0767 MMC (MEJ), 2010 WL 2672003 (N.D. Cal. July 2, 2010), 4-43

Kaspar Wire Works, Inc. v. Leco Eng'g & Mach., Inc., 575 F.2d 530 (5th Cir. 1978), 5-95

Kathawala, *In re*, 9 F.3d 942 (Fed. Cir. 1993), 14-60

Katz Interactive Call Processing Patent Litig., *In re*, 639 F.3d 1303 (Fed. Cir. 2011), 2-11, 5-11, 8-29

Katz v. Batavia Marine & Sporting Supplies, Inc., 984 F.2d 422 (Fed. Cir. 1993), 4-32

Patent Case Management Judicial Guide, Third Edition

Katz v. Lear Siegler, Inc., 909 F.2d 1459 (Fed. Cir. 1990), 2-29, 2-30, 2-51, 2-52, 2-72, 2-73
Kaufman Co. v. Lantech, Inc., 807 F.2d 970 (Fed. Cir. 1986), 14-28
Kaufman Co. v. Lantech, Inc., 926 F.2d 1136 (Fed. Cir. 1991), 8-34
KCJ Corp. v. Kinetic Concepts, Inc., 223 F.3d 1351 (Fed. Cir. 2000), 5-72
Kegel Co., Inc. v. AMF Bowling, Inc., 127 F.3d 1420 (Fed. Cir. 1997), 5-77
Kendall v. Winsor, 62 U.S. 322 (1858), 1-7
Kenexa Brassring Inc. v. Taleo Corp., 2009 WL 393782, U.S. Dist. LEXIS 12002 (D. Del. Feb. 18, 2009),
4-12
Kerotest Manufacturing Co. v. C-O-Two Fire Equip. Co., 342 U.S. 180 (1952), 2-51
Keurig, Inc. v. Sturm Foods, Inc., 732 F.3d 1370 (Fed. Cir. 2013), 14-90
Key Pharmaceuticals v. Hercon Labs. Corp., 161 F.3d 709 (Fed. Cir. 1998), 5-36, 5-88, 5-89
Keystone Driller Co. v. General Excavator Co., 290 U.S. 240 (1933), 1-8, 14-93
Kilopass Technology, Inc. v. Sidense Corp., No. 10-cv-2066, 2014 U.S. Dist. LEXIS 112321, 2014 WL
3956703 (N.D. Cal. Aug. 12, 2014), 9-14
Kim Brothers v. Hagler, 167 F. Supp. 665 (S.D. Cal. 1958), *aff'd*, 276 F.2d 259 (9th Cir. 1960), 12-6
Kimball v. RJ Reynolds Tobacco Co., 2006 U.S. Dist. LEXIS 27138, 2006 WL 1148506 (W.D. Wash. Apr.
26, 2006), 7-50
Kimberly-Clark Corp. v. James River Corp., 131 F.R.D. 607 (N.D. Ga. 1989), 8-4
Kimberly-Clark Corp. v. Proctor & Gamble Distrib. Co., 973 F.2d 911 (Fed. Cir. 1992), 14-76
Kimble v. Marvel Entertainment, LLC, 135 S. Ct. 2401 (2015), 14-95, 14-99
Kinetic Concepts, Inc. v. Blue Sky Med. Grp. Inc., 554 F.3d 1010 (Fed. Cir. 2009), 5-67
Kinetic Concepts, Inc. v. Smith & Nephew, Inc., 688 F.3d 1342 (Fed. Cir. 2012), 7-12, 7-13, 8-6, 9-18
King Drug Co. of Florence, Inc. v. Smithkline Beecham Corp., No. 14-1243, 2015 WL 3967112 (3d Cir.
June 26, 2015), 10-22, 10-23
Kingsdown Medical Consultants, Ltd. v. Hollister, Inc., 863 F.2d 867 (Fed. Cir. 1988), 4-30, 14-93
Kirtsaeng v. John Wiley & Sons, Inc., 133 S. Ct. 1351 (2013), 14-91
Klopfenstein, *In re*, 380 F.3d 1345 (Fed. Cir. 2004), 14-53, 14-54
Kmart Corp., *In re*, 371 B.R. 823 (Bankr. N.D. Ill. 2007), 4-41
Knorr-Bremse Systeme Fuer Nutzfahrzeuge GmbH v. Dana Corp., 383 F.3d 1337 (Fed. Cir. 2004), 7-32,
7-35, 14-112
Koehring, *In re*, 37 F.2d 421 (C.C.P.A. 1930), 11-2, 11-3
Koito Manufacturing Co., Ltd. v. Turn-Key-Tech, LLC, 381 F.3d 1142 (Fed. Cir. 2004), 5-77
Kollar, *In re*, 286 F.3d 1326 (Fed. Cir. 2002), 14-59
Kollmorgen Corp. v. Yaskawa Elec. Corp., 147 F. Supp. 2d 464 (W.D. Va. 2001), 5-91, 5-92, 5-93, 5-94
Kraft Foods, Inc. v. International Trading Co., 203 F.3d 1362 (Fed. Cir. 2000), 5-70
KRB Seed Co., *In re*, 76 U.S.P.Q.2d (BNA) 1156 (T.T.A.B. 2005), 12-13
Kropa v. Robie, 187 F.2d 150 (CCPA 1951), 5-71
Krumwiede v. Brighton Assocs., L.L.C., No. 05-C- 3003, 2006 WL 1308629 (N.D. Ill. May 8, 2006), 4-41
KSM Fastening Systems, Inc. v. H.A. Jones Co., 776 F.2d 1522 (Fed. Cir. 1985), 3-31
KSR International Co. v. Teleflex Inc., 550 U.S. 398 (2007), 1-10, 6-8, 6-16, 6-26, 6-32, 6-33, 6-34, 7-9,
7-10, 7-11, 7-24, 8-31, 11-12, 12- 8, 14-10, 14-64, 14-68, 14-70, 14-71, 14-74
KSR v. Teleflex, 75 Fed. Reg. 53643 (2010), 14-71
Kubin, *In re*, 561 F.3d 1351 (Fed. Cir. 2009), 14-74

Table of Cases

KX Industries, L.P. v. PUR Water Purification Prods., Inc., 108 F. Supp. 2d 380 (D. Del. 2000), 5-100
L.A. Gear, Inc. v. Thom McAn Shoe Co., 988 F.2d 1117 (Fed. Cir. 1993), 11-2, 11-7, 11-10
L.C. Eldridge Sales Co., Ltd. v. Jurong Shipyards PTE, Ltd., No. 11-cv-599 (E.D. Tex. Sept. 23, 2014), 9-15
Laboratory Corp. of America Holdings v. Chiron Corp., 384 F.3d 1326 (Fed. Cir. 2004), 14-114, 14-116
Laitram Corp. v. Rexnord, Inc., 939 F.2d 1533 (Fed. Cir. 1991), 5-70, 5-71
Lamictal Direct Purchaser Antitrust Litigation, *In re*, No. 12-cv-995, 2014 WL 282755 (D.N.J. Jan. 24, 2014), 10-22
Lampi Corp. v. Am. Power Prods., Inc., 228 F.3d 1365 (Fed. Cir. 2000), 5-74, 5-97
Landis v. N. Am. Co., 299 U.S. 248 (1936), 2-50
Larson v. United States, 26 Cl. Ct. 365 (1992), 13-5
Laryngeal Mask Co. Ltd. v. Ambu S/A, 618 F.3d 1367 (Fed. Cir. 2010), 5-61
LaserDynamics, Inc. v. Quanta Comput., Inc., 694 F.3d 51 (Fed. Cir. 2012), 4-34, 7-19, 7-20, 8-35, 8-36, 8-38, 8-40, 14-107, 14-108
Latimer, *Ex parte*, 1889 Comm'n Dec. Pat. 123 (1889), 12-1
Laughlin Products, Inc., Patent Litig., *In re*, 265 F. Supp. 2d 525 (E.D. Pa. 2003), 2-65
Lava Trading, Inc. v. Sonic Trading Mgmt., LLC, 445 F.3d 1348 (Fed. Cir. 2006), 5-32, 6-12
Le Roy v. Tatham, 55 U.S. (14 How.) 156 (1853), 1-3, 1-7, 14-33
Leader Technologies Inc. v. Facebook Inc., Civ. No. 08-862-JJF-LPS, 2009 WL 3021168, 2009 U.S. Dist. LEXIS 93807 (D. Del. Sept. 4, 2009), 4-22
Leapfrog Enterprises, Inc. v. Fisher-Price, Inc., 485 F.3d 1157 (Fed. Cir. 2007), 7-11, 14-71
Lear Siegler, Inc. v. Sealy Mattress Co., 873 F.2d 1422 (Fed. Cir. 1989), 6-4
Lear, Inc. v. Adkins, 395 U.S. 653 (1969), 5-102, 9-18, 14-98, 14-99, 14-100
Lee v. Dayton-Hudson Corp., 838 F.2d 1186 (Fed. Cir. 1988), 11-9
Leesona Corp. v. United States, 599 F.2d 958 (Ct. Cl. 1979), 13-1, 13-3, 13-4, 13-8
Legal Voice v. Stormans Inc., 738 F.3d 1178 (9th Cir. 2013), 4-7
LeGrice, *In re*, 301 F.2d 929 (C.C.P.A. 1962), 12-8
Lemelson v. United States, 752 F.2d 1538 (Fed. Cir. 1985), 13-7
Leon v. IDX Systems Corp., 2004 WL 5571412 (W.D. Wash. 2004), 4-43
Lexion Medical, LLC v. Northgate Techs., Inc., 641 F.3d 1352 (Fed. Cir. 2011), 5-51
Lexmark International, Inc. v. Impression Prods., Inc., — F.3d —, 2016 WL 559042 (Fed. Cir. 2016), 14-90, 14-91
LG Electronics, Inc. v. Bizcom Elecs., Inc., 453 F.3d 1364 (Fed. Cir. 2006), 5-68
LG Electronics, Inc. v. Q-Lity Computer, Inc., 211 F.R.D. 360 (N.D. Cal. 2002), 2-14
Libman Co. v. Quickie Mfg. Corp., 74 F. App'x 900 (Fed. Cir. 2003), 5-76
Lighting Ballast Control LLC v. Philips Elecs. N. Am. Corp., 744 F.3d 1272 (Fed. Cir. 2014) (en banc), 2-19, 5-4
Lighting World, Inc. v. Birchwood Lighting, Inc., 382 F.3d 1354 (Fed. Cir. 2004), 5-80
Liljeberg v. Health Servs. Acquisition Corp., 486 U.S. 847 (1988), 9-19
Limelight Networks, Inc. v. Akamai Techs., Inc., 134 S. Ct. 2111 (2014), 2-77, 6-15, 6-40, 7-17, 14-78
Lincoln National Life Ins. Co. v. Jackson Nat. Life Ins. Co., 2013 U.S. Dist. LEXIS 155502, 2013 WL 5874448 (N.D. Ind. 2013), 5-94
Linder v. Calero-Portocarrero, 251 F.3d 178 (D.C. Cir. 2001), 4-7
Linear Technology Corp. v. Impala Linear Corp., 31 F. App'x 700 (Fed. Cir. 2002), 5-32

Patent Case Management Judicial Guide, Third Edition

Linear Technology Corp. v. Impala Linear Corp., 379 F.3d 1311 (Fed. Cir. 2004), 6-3
Linear Technology Corp. v. Int'l Trade Comm'n, 566 F.3d 1049 (Fed. Cir. 2009), 5-74
Linear Technology Corp. v. Micrel Inc., 275 F.3d 1040 (Fed. Cir. 2001), 14-59
Link_A_Media Devices Corp., *In re*, 662 F.3d 1221 (Fed. Cir. 2011), 2-64, 2-65
Lipitor Antitrust Litigation, *In re*, No. 3:12-cv-02389 (PGS), 2014 WL 4543502 (D.N.J. Sept. 12, 2014), 10-22, 10-23
Lister, *In re*, 583 F.3d 1307 (Fed. Cir. 2009), 8-27
Litton Industries Prods., Inc. v. Solid State Systems, Corp., 755 F.2d 158 (Fed. Cir. 1985), 14-66
Litton Systems, Inc. v. Whirlpool Corp., 728 F.2d 1423 (Fed. Cir. 1984), 11-12
LizardTech, Inc. v. Earth Res. Mapping, Inc., 424 F.3d 1336 (Fed. Cir. 2005), 14-47
LML Patent Corp. v. JPMorgan Chase & Co., Case No. 08-cv-448, 2010 U.S. Dist. LEXIS 136452, 2010 WL 5140823 (E.D. Tex. Oct. 12, 2010), 8-29
Lockheed Martin Corp. v. Space Systems/Loral, Inc., 324 F.3d 1308 (Fed. Cir. 2003), 6-9
Loestrin 24 Fe Antitrust Litig., *In re*, No. 1:13-md-2472-S-PAS, 2014 WL 4368924 (D.R.I. Sept. 4, 2014), 10-22
Logic Devices, Inc. v. Apple Inc., No. 13-2943, 2014 U.S. Dist. LEXIS 168380, 2014 WL 6844821 (N.D. Cal. Dec. 4, 2014), 9-14
Lough v. Brunswick Corp., 86 F.3d 1113 (Fed. Cir. 1996), 14-58
Lowell v. Lewis, 15 F. Cas. 1018, No. 8568 (C.C.D. Mass. 1817), 1-6
Lowery v. Stovall, 92 F.3d 219 (4th Cir. 1996), 5-97, 5-98
Loyalty Conversion Systems Corp. v. Am. Airlines, Inc., No. 2:13-CV-655, 2014 U.S. Dist. LEXIS 122244, 2014 WL 4364848 (E.D. Tex. Sept. 2, 2014), 6-19
Lucent Technologies, Inc. v. Gateway, Inc., 580 F.3d 1301 (Fed. Cir. 2009), 1-10, 4-32, 7-19-7-20, 7-37, 8-34-8-35, 8-36, 8-37, 8-41, 14-105, 14-108
Lucent Technologies, Inc. v. Gateway, Inc., Nos. 07-CV-2000-H (CAB), 02-CV-2060-B (CAB), 03-CV-0699-B (CAB), 03-CV-1108-B (CAB), 2007 WL 6955272, 2007 U.S. Dist. LEXIS 95934 (S.D. Cal. Oct. 30, 2007), 3-17
Lucent Technologies, Inc. v. Microsoft Corp., 837 F. Supp. 2d 1107 (S.D. Cal. 2011), 7-37
Lumen View Tech. LLC v. Findthebest.com, Inc., 2016 U.S. App. LEXIS 1087 (Fed. Cir. Jan. 22, 2016), 9-12
Lumen View Tech., LLC v. Findthebest.com, Inc., 63 F. Supp. 3d 321 (S.D.N.Y. 2014), 9-14
Lumenis, Inc., *In re*, 89 F. App'x 255 (Fed. Cir. 2004), 3-30
Lummus Co. v. Commonwealth Oil Ref. Co., 297 F.2d 80 (2d Cir. 1961), 5-94
Lytton Systems Inc. v. Whirlpool, 728 F.2d 1423 (Fed. Cir. 1984), 11-7
M/A-COM Tech. Solutions Holdings Inc. v. Laird Techs. Inc., C.A. No. 14-181-LPS (D. Del. July 31, 2014), 4-13
MacNeill Engineering Co. v. Trisport, Ltd., 126 F. Supp. 2d 51 (D. Mass. 2001), 5-24
Macronix Int'l Co. v. Spansion Inc., 4 F. Supp. 3d 797 (E.D. Va. 2014), 2-41
Madey v. Duke Univ., 307 F.3d 1351 (Fed. Cir. 2002), 6-5, 14-91
Magarl, L.L.C. v. Crane Co., 2004 U.S. Dist. LEXIS 24283, 2004 WL 2750252 (S.D. Ind. 2004), 5-6
Magic Ruffle Co. v. Douglas, 16 F. Cas. 394, No. 8948 (C.C.S.D. N.Y. 1863), 1-7
Magna Donnelly Corp. v. Pilkington N. Am., Inc., 2007 U.S. Dist. LEXIS 17536, 2007 WL 772891 (W.D. Mich. Mar. 12, 2007), 2-55
MagSil Corp. v. Hitachi Global Storage Techs., Inc., 687 F.3d 1377 (Fed. Cir. 2012), 6-16

Table of Cases

- Mahurkar v. C.R. Bard Inc., 79 F.3d 1572 (Fed. Cir. 1996), 14-55
- Malarkey v. Texaco, Inc., 794 F. Supp. 1248 (S.D.N.Y. 1992), 9-20
- Malek v. Fed. Ins. Co., 994 F.2d 49 (2d Cir. 1993), 8-15
- Mallinckrodt Inc. v. E-Z-EM Inc., 670 F. Supp. 2d 349 (D. Del. 2009), 2-41
- Mallinckrodt, Inc. v. Medipart, Inc., 976 F.2d 700 (Fed. Cir. 1992), 14-90
- Malta v. Schulmerich Carillons, Inc., 952 F.2d 1320 (Fed. Cir. 1991), 6-4
- Man Machine Interface Techs., LLC v. Funai Corp., *et al.*, CV 10-8629 (C.D. Cal. Apr. 7, 2011), 2-37
- Managed Care Solutions, Inc. v. Essent Healthcare, Inc., No. 09-60351-CIV, 2010 WL 3368654 (S.D. Fla. Aug. 23, 2010), 4-45
- Mann, *In re*, 861 F.2d 1581 (Fed. Cir. 1988), 11-11
- Market-Alerts Pty. Ltd. v. Bloomberg Fin. L.P., 922 F. Supp. 2d 486 (D. Del. 2013), 2-57
- Markman v. Westview Instruments, Inc., 517 U.S. 370 (1996), 2-13, 2-19, 2-76, 5-3, 5-4, 5-33, 5-47, 5-59, 5-88, 5-89, 6-3, 6-5, 6-7, 7-50
- Markman v. Westview Instruments, Inc., 52 F.3d 967 (Fed. Cir. 1995), 5-46, 8-42, 14-111
- Mars Inc. v. Kabushiki-Kaisha Nippon Conlux, 24 F.3d 1368 (Fed. Cir. 1994), 14-115
- Mars, Inc. v. Coin Acceptors, Inc., 527 F.3d 1359 (Fed. Cir. 2008), 7-33
- Mars, Inc. v. H.J. Heinz Co., 377 F.3d 1369 (Fed. Cir. 2004), 5-74
- Martek Biosciences Corp. v. Nutrinova Inc., 579 F.3d 1363 (Fed. Cir. 2009), 5-68
- Masco Corp. v. United States, 49 Fed. Cl. 337 (Ct. Cl. 2001), 5-92
- Masimo Corp. v. Philips Elecs. N. Am. Corp., 918 F. Supp. 2d 277 (D. Del. 2013), 5-11
- Massachusetts Institute of Technology v. Abacus Software, 462 F.3d 1344 (Fed. Cir. 2006), 5-41, 5-42, 6-12, 8-2
- MasterObjects, Inc. v. Google Inc., 582 F. App'x 893 (Fed. Cir. 2014), 5-26
- Mattox v. Infotopia, Inc., 136 F. App'x 366 (Fed. Cir. 2005), 5-77
- Mayeaux v. Am. Mut. Liberty Ins. Corp., 409 F.2d 508 (5th Cir. 1969), 8-42
- Mayo Collaborative Services v. Prometheus Laboratories, Inc., 132 S. Ct. 1289 (2012), 1-1, 1-3, 2-76, 6-9, 6-17, 6-30, 14-29, 14-42-14-43
- Mazloun v. D.C. Metro. Police Dep't, 530 F. Supp. 2d 282 (D.D.C. 2008), 4-46
- Mazzari v. Rogan, 323 F.3d 1000 (Fed. Cir. 2003) 14-113
- MBO Laboratories, Inc. v. Becton, Dickinson & Co., 474 F.3d 1323 (Fed. Cir. 2007), 5-60, 5-71
- McCormick-Morgan, Inc. v. Teledyne Indus., Inc., 765 F. Supp. 611 (N.D. Cal. 1991), 4-8
- McDaniel v. Anheuser-Busch, Inc., 987 F.2d 298 (5th Cir. 1993), 8-4
- McElmurry v. Ark. Power & Light Co., 995 F.2d 1576 (Fed. Cir. 1993), 14-91
- McZeal v. Sprint Nextel Corp., 501 F.3d 1354 (Fed. Cir. 2007), 2-39, 2-40, 4-25
- Maryland Casualty Co. v. Pacific Coal & Oil Co., 312 U.S. 270 (1941), 2-33
- MeccaTech, Inc. v. Kiser, 2008 WL 6010937 (D. Neb. 2008), 4-42
- Media Communications, LLC v. Int'l Trade Comm'n, 161 F.3d 696 (Fed. Cir. 1998), 5-87
- Media Rights Techs. v. Capital One Financial Corp., 800 F.3d 1366 (Fed. Cir. 2015), 5-80
- Medien Patent Verwaltung AG v. Warner Bros. Entm't, 2014 U.S. Dist. LEXIS 12360, 2014 WL 333470 (S.D.N.Y. Jan. 29, 2014), 5-10
- MedImmune, Inc. v. Genentech, Inc., 549 U.S. 118 (2007), 2-33, 2-34, 2-36, 7-43
- Medpointe Healthcare, Inc. v. Hi-Tech Pharmacal Co., Inc., Civ. Action Nos. 03-5550 (MLC), 04-1686 (MLC), 2007 WL 188285, 2007 U.S. Dist. LEXIS 4652 (D.N.J. Jan. 22, 2007), 4-28

Patent Case Management Judicial Guide, Third Edition

Medtrica Solutions Ltd. v. Cygnus Med. LLC, No. 12-cv-538 (W.D. Wash. July 11, 2014), 9-13
Medtronic Inc. v. Guidant Corp., 465 F.3d 1360 (Fed. Cir. 2006), 7-49
Meese v. Eaton Mfg. Co., 35 F.R.D. 162 (N.D. Ohio 1964), 2-39
Mentor Corp. v. Coloplast, Inc., 998 F.2d 992 (Fed. Cir. 1993), 14-21
Mentor Graphics Corp. v. Quickturn Design Systems, 150 F.3d 1374 (Fed. Cir. 1998), 2-35, 2-36, 14-98, 14-99
Mentor Graphics Corp. v. Quickturn Design Systems, 999 F. Supp. 1388 (D. Or. 1997), 2-50
Mentor H/S, Inc. v. Med. Device Alliance, Inc., 240 F.3d 1016 (Fed. Cir. 2001), 2-29, 2-30
Menz v. New Holland N. Am., Inc., 440 F.3d 1002 (8th Cir. 2006), 4-42
MercExchange, L.L.C. v. eBay, Inc., 500 F. Supp. 2d 556 (E.D. Va. 2007), 2-55
Merck KGaA v. Integra Lifesciences I, Ltd., 545 U.S. 193(2005), 14-91
Merial Ltd. v. Cipla Ltd., 681 F.3d 1283(Fed. Cir. 2012), 2-51, 2-52
Metro-Goldwyn-Mayer Studios Inc. v. Grokster, Ltd., 545 U.S. 913 (2005), 14-79
Micro Motion, Inc. v. Exac Corp., 741 F. Supp. 1426 (N.D. Cal. 1990), 14-66
Micro Motion, Inc. v. Kane Steel Co., 894 F.2d 1318 (Fed. Cir. 1990), 8-34
Micron Technology, Inc. v. Mosaid Techs., Inc., 518 F.3d 897 (Fed. Cir. 2008), 2-34,
Micron Technology, Inc. v. Rambus Inc., 645 F.3d 1311 (Fed. Cir. 2011), 2-74, 4-20
Micron Technology, Inc. v. Mosel Vitelic Corp., 1999 U.S. Dist. LEXIS 4792, 1999 WL 458168 (D. Idaho 1999), 2-49, 2-50
Microsoft Corp. v. AT&T Corp., 550 U.S. 437 (2007), 14-88
Microsoft Corp. v. i4i Ltd. P'ship, 131 S. Ct. 2238 (2011), 1-13, 6-30, 7-8, 7-9, 8-31, 8-32, 8-33, 9-17, 14-28, 14-29, 14-97
Microsoft Corp. v. i4i Ltd. P'ship, 598 F.3d 831 (Fed. Cir. 2010), 8-41
Microsoft Corp. v. Motorola, Inc., 904 F. Supp. 2d 1109 (W.D. Wash. 2012), 7-38
Microsoft Corp. v. Motorola, Inc., No. C10-1823JLR, 2013 U.S. Dist. LEXIS 60233, 2013 WL 2111217 (W.D. Wash. Apr. 25, 2013), 8-39, 14-110
Microsoft Corp. v. Multi-Technology Systems, Inc., 357 F.3d 1340 (Fed. Cir. 2004), 5-65
Microsoft Corp., *In re*, 630 F.3d 1361 (Fed. Cir. 2011), 2-63, 2-64
Middleton, Inc. v. Minn. Mining & Mfg. Co., 411 F.3d 1384 (Fed. Cir. 2002), 5-77
Midwest Industries, Inc. v. Karavan Trailers, Inc., 175 F.3d 1356 (Fed. Cir. 1999), 2-46, 4-2, 14-115
Migra v. Warren City Sch. Dist. Bd. of Educ., 465 U.S. 75 (1984), 5-90
Miken Composites, L.L.C. v. Wilson Sporting Goods Co., 515 F.3d 1331 (Fed. Cir. 2008), 5-99
Mikohn Gaming Corp. v. Acres Gaming, Inc., 165 F.3d 891 (Fed. Cir. 1998), 3-7, 3-9
Miller v. Home Depot USA, Inc., No. 3-08-0281, 2010 WL 373860 (M.D. Tenn. Jan. 28, 2010), 4-40
Minco Inc. v. Combustion Eng'g, 95 F.3d 1109 (Fed. Cir. 1996), 2-31
Minebea Co., *In re*, 143 F.R.D. 494 (S.D.N.Y. 1992), 4-29
Minnesota Mining & Mfg. Co. v. Barr Labs., Inc., 289 F.3d 775 (Fed. Cir. 2002), 10-8
Minnesota Mining Co. v. Nat'l Mining Co., 70 U.S. 332 (1865), 5-100
Minton v. National Ass'n of Sec. Dealers, Inc., 336 F.3d 1373 (Fed. Cir. 2003), 9-16
Mirror Worlds LLC v. Apple, Inc., 784 F. Supp. 2d 703 (E.D. Tex. 2011), 7-27
Moba, B.V. v. Diamond Automation, Inc., 325 F.3d 1306 (Fed. Cir. 2003), 7-51
Modine Manufacturing Co. v. Allen Grp., Inc., 917 F.2d 538 (Fed. Cir. 1990), 9-11
Modine Manufacturing Co. v. USITC, 75 F.3d 1545 (Fed. Cir. 1996), 5-51

Table of Cases

Mogen David Wine Corp., *In re*, 328 F.2d 925 (C.C.P.A. 1964), 11-6
Moleculon Research Corp. v. CBS, Inc., 793 F.2d 1261 (Fed. Cir. 1986), 6-5, 7-49, 8-30
Monolith Portland Midwest Co. v. Kaiser Aluminum & Chem. Corp., 407 F.2d 288 (9th Cir. 1969), 9-16
Monolithic Power Systems, Inc. v. O2 Micro Int'l Ltd., 558 F.3d 1341 (Fed. Cir. 2009), 8-22
Monsanto Co. v. Byrd, No. 7:99-CV-154-F1, 2000 WL 33952260, 2000 U.S. Dist. LEXIS 22793
(E.D.N.C. Dec. 11, 2000), 12-10
Monsanto Co. v. Geertson Seed Farms, 561 U.S. 139 (2010), 9-3
Monsanto Co. v. McFarling (*McFarling I*), 302 F.3d 1291 (Fed. Cir. 2002), 12-11
Monsanto Co. v. McFarling (*McFarling II*), 363 F.3d 1336 (Fed. Cir. 2004), 12-11, 14-90, 14-94
Monsanto Co. v. McFarling, 488 F.3d 973 (Fed. Cir. 2007), 8-37, 14-108
Monsanto Co. v. Mycogen Plant Sci., Inc., 261 F.3d 1356 (Fed. Cir. 2001), 6-8
Monsanto Co. v. Mycogen Plant Sci., Inc., 61 F. Supp. 2d 133 (D. Del. 1999), 14-88
Monsanto Co. v. Parr, 545 F. Supp. 2d 836 (N.D. Ind. 2008), 12-12
Monsanto Co. v. Ralph, 382 F.3d 1374 (Fed. Cir. 2004), 4-47
Monsanto Co. v. Scruggs, 459 F.3d 1328 (Fed. Cir. 2006), 6-3
Monsanto Co. v. Woods, 250 F.R.D. 411 (E.D. Mo. 2008), 4-42
Moore, *Ex parte*, 115 U.S.P.Q. (BNA) 145 (Pat. Off. Bd. App. 1957), 12-6
More v. Snow, 480 F. Supp. 2d 257 (D.D.C. 2007), 4-46
Morton-Norwich Prods., Inc., *In re*, 671 F.2d 1322 (C.C.P.A. 1982), 11-6
Morvant v. Constr. Aggregates Corp., 570 F.2d 626 (6th Cir. 1978), 8-16
Mosaid Technologies, Inc. v. Samsung Elecs. Co., 348 F. Supp. 2d 332 (D.N.J. 2004), 4-37
Motion Picture Patents Co. v. Universal Film Mfg. Co., 243 U.S. 502 (1917), 1-7, 1-8
Motionless Keyboard Co. v. Microsoft Corp., 486 F.3d 1376 (Fed. Cir. 2007), 6-7
Motorola v. Interdigital Technology Corp., 930 F. Supp. 952 (D. Del. 1990), 8-10
Motorola, Inc. v. Interdigital Technology Corp., No. Civ.A. 93-488-LON, 1994 WL 16189689, 1994 U.S.
Dist. LEXIS 20714 (D. Del. Dec. 19, 1994), 4-31
Motorola, Inc. v. United States, 729 F.2d 765 (Fed. Cir. 1984), 13-1, 13-7, 13-8
Moxness Products, Inc. v. Xomed Inc., 1988 U.S. Dist. LEXIS 16060, 1988 WL 193213 (N.D. Fla. 1988),
9-20
Moylan v. Meadow Club, Inc., 979 F.2d 1246 (7th Cir. 1992), 8-15
MRC Innovations, Inc. v. Hunter Mfg., LLP, 135 S. Ct. 182 (2014), 11-12
MRC Innovations, Inc. v. Hunter Mfg., LLP, 747 F.3d 1326 (Fed. Cir. 2014), 11-12
MSTG, *In re*, 675 F.3d 1337 (Fed. Cir. 2012), 4-32, 4-33
Mullally v. Jones, No. 2:05CV00154-BES-GWF, 2007 WL 1213704, 2007 U.S. Dist. LEXIS 30283 (D.
Nev. Apr. 24, 2007), 4-27
Multiform Desiccants, Inc. v. Medzam, Ltd., 133 F.3d 1473 (Fed. Cir. 1998), 2-19, 5-53
Muniauction, Inc. v. Thomson Corp., 532 F.3d 1318 (Fed. Cir. 2008), 2-77, 6-14, 6-40, 7-17, 14-72
MyKey Technology Inc. Patent Litig., *In re*, 2014 U.S. Dist. LEXIS 83147, 2014 WL 2740733 (C.D. Cal.
2014), 5-9
Mylan Laboratories, Inc. v. Thompson, 389 F.3d 1272 (D.C. Cir. 2004), 10-16
Mylan Pharmaceuticals, Inc. v. Thompson, 268 F.3d 1323 (Fed. Cir. 2001), 3-9
MyMail Ltd. v. AOL, Inc., 223 F.R.D. 455 (E.D. Tex. 2004), 2-37
MyMail, Ltd. v. Am. Online, Inc., 476 F.3d 1372 (Fed. Cir. 2007), 2-24

Patent Case Management Judicial Guide, Third Edition

National Century Financial Enterprises, Inc. Fin. Inv. Litig., *In re*, No. 2:03-md-1565, 2009 WL 2169174 (S.D. Ohio July 16, 2009), 4-40

National Grange Mutual Insurance Co. v. Hearth & Home, Inc., No. CIV.A. 2:06 CV 54WCO, 2006 WL 5157694 (N.D. Ga. Dec. 19, 2006), 4-45

National Lead Co. v. W. Lead Prods. Co., 324 F.2d 539 (9th Cir. 1963), 14-35

National Presto Indus., Inc. v. W. Bend Co., 76 F.3d 1185 (Fed. Cir. 1996), 3-29, 9-11

National Recovery Techs., Inc. v. Magnetic Separation Systems, Inc., 166 F.3d 1190 (Fed. Cir. 1999), 14-48

Nautilus, Inc. v. Biosig Instruments, Inc., 134 S. Ct. 2120 (2014), 5-48, 5-49, 5-84, 5-85, 5-87, 6-15, 6-35, 6-36, 14-50–14-51

Navellier v. Sletten, 262 F.3d 923 (9th Cir. 2001), 8-12

Neil Brothers Ltd. v. World Wide Lines, Inc., 425 F. Supp. 2d 325 (E.D.N.Y. 2006), 2-63

Neilson v. Harford (1841), 14-32, 14-33

Net MoneyIN, Inc. v. VeriSign, Inc., 545 F.3d 1359 (Fed. Cir. 2008), 5-81

Network, LLC v. Centraal Corp., 242 F.3d 1347 (Fed. Cir. 2001), 5-58, 5-66

Network Commerce, Inc. v. Microsoft Corp., 422 F.3d 1353 (Fed. Cir. 2005), 5-43

New Hampshire v. Maine, 532 U.S. 742 (2001), 5-90, 5-97

Newell Cos. v. Kenney Mfg. Co., 864 F.2d 757 (Fed. Cir. 1988), 5-99

Nexium (Esomeprazole) Antitrust Litigation, *In re*, 968 F. Supp. 2d 367 (D. Mass. 2013), 10-22

Niaspan Antitrust Litigation, *In re*, No. 13-MD-2460, 2014 WL 4403848 (E.D. Pa. Sept. 5, 2014), 10-22

Nichols v. Scott, 69 F.3d 1255 (5th Cir. 1995), 5-97

Nikken USA, Inc. v. Robinson-May, Inc., 1999 WL 1046620, 1999 U.S. App. LEXIS 31925 (Fed. Cir. Oct. 25, 1999), 3-29

Nintendo Co., *In re*, 589 F.3d 1194 (Fed. Cir. 2009), 2-62, 2-64, 2-65

Nintendo, *In re*, 756 F.3d 1363 (Fed. Cir. 2014), 2-63, 2-64

Nobelpharma AB v. Implant Innovations, Inc., 141 F.3d 1059 (Fed. Cir. 1998), 2-46, 14-100

Norman IP Holdings, LLC v. Lexmark International, Inc., 2012 U.S. Dist. LEXIS 112757, 2012 WL 3307942 (E.D. Tex. 2012), 5-27

North American Container, Inc. v. Plastipak Packaging, Inc., 415 F.3d 1335 (Fed. Cir. 2005), 5-60

North Star Genetics, Ltd. v. Bata, No. CIV. A3-00-57, 2001 WL 1820380, 2001 U.S. Dist. LEXIS 20065 (D.N.D. Aug. 9, 2001), 12-9–12-10

Northlake Mktg. & Supply, Inc. v. Glaverbel, S.A., 72 F. Supp. 2d 893 (N.D. Ill. 1999), 8-34

Norwood v. Kirkpatrick, 349 U.S. 29 (1955), 2-61, 2-62

Nova Measuring Instruments Ltd. v. Nanometrics, Inc., 417 F. Supp. 2d 1121 (N.D. Cal. 2006), 2-15, 4-25

Novo Industries, L.P. v. Micro Molds Corp., 350 F.3d 1348 (Fed. Cir. 2003), 5-83, 5-84

Novo Nordisk A/S v. Caraco Pharm. Labs., Ltd., 719 F.3d 1346 (Fed. Cir. 2014), 7-11

Novo Nordisk A/S v. Sanofi-Aventis U.S. LLC, Civ. Action No. 07-3206 (MLC), 2008 WL 6098829, 2008 U.S. Dist. LEXIS 12342 (D.N.J. Feb. 19, 2008), 3-12, 3-26

NTL, Inc. Securities Litigation, *In re*, 244 F.R.D. 179 (S.D.N.Y. 2007), 4-36

NTP, Inc. v. Research in Motion, Ltd., 418 F.3d 1282 (Fed. Cir. 2005), 8-17, 14-89

NTP, Inc., *In re*, 654 F.3d 1279 (Fed. Cir. 2011), 5-40, 8-27

Nuijten, *In re*, 500 F.3d 1346 (Fed. Cir. 2007), 6-17, 14-40

Nutrition 21 v. United States, 930 F.2d 867 (Fed. Cir. 1991), 3-7

Table of Cases

- Nycomed, Inc. v. Glenmark Generics Ltd., 2009 U.S. Dist. LEXIS 95780, 2009 WL 3334365 (E.D.N.Y. Oct. 14, 2009), 10-5
- Nystrom v. TREX Co., 339 F.3d 1347 (Fed. Cir. 2003), 5-32, 14-116
- Nystrom v. TREX Co., 424 F.3d 1136 (Fed. Cir. 2005), 5-37, 5-67
- O'Farrell, *In re*, 853 F.2d 894 (Fed. Cir. 1988), 14-76
- O'Reilly v. Morse, 56 U.S. 62 (1853), 1-3, 1-7, 14-33
- O'Rourke v. Smithsonian Inst. Press, 399 F.3d 113 (2d Cir. 2005), 13-6-13-7
- O2 Micro International Ltd. v. Beyond Innovation Tech. Co., 521 F.3d 1351 (Fed. Cir. 2008), 2-10, 5-10, 5-11, 5-29, 5-30, 5-48, 5-52, 8-17
- O2 Micro International Ltd. v. Monolithic Power Systems, 467 F.3d 1355 (Fed. Cir. 2006), 2-14, 2-15, 2-23, 2-42, 4-25
- Oakley, Inc. v. Int'l Tropic-Cal, Inc., 923 F.2d 167 (Fed. Cir. 1991), 3-7
- Oakley, Inc. v. Sunglass Hut Int'l, No. SA CV 01-1065 AHS, 2001 WL 1683252, 2001 U.S. Dist. LEXIS 23572 (C.D. Cal. Dec. 7, 2001), 3-26, 3-27, 3-29
- Oatey Co. v. IPS Corp., 514 F.3d 1271 (Fed. Cir. 2008), 5-60
- Octane Fitness LLC v. Icon Health & Fitness, Inc., 134 S. Ct. 1749 (2014), 1-2, 7-14, 9-12, 14-112
- Oda, *In re*, 443 F.2d 1200 (C.C.P.A. 1971), 14-19
- OddzOn Prods., Inc. v. Just Toys, Inc., 122 F.3d 1396 (Fed. Cir. 1997), 11-9, 11-11, 14-57, 14-60, 14-67
- Odom v. Microsoft Corp., 429 F. App'x 967, 2011 U.S. App. LEXIS 9115 (Fed. Cir. 2011), 6-16, 6-35, 7-11
- Ohio Willow Wood Co. v. Alps South, LLC, 735 F.3d 1333 (Fed. Cir. 2013), 6-32, 6-34, 6-35, 6-44
- Ohio Willow Wood Co. v. Thermo-Ply, Inc., 629 F.3d 1374 (Fed. Cir. 2011), 5-102, 9-19
- Omeprazole Patent Litigation, *In re*, 536 F.3d 1361 (Fed. Cir. 2008), 14-71
- On Demand Mach. Corp. v. Ingram Indus., Inc., 442 F.3d 1331 (Fed. Cir. 2006), 5-71
- On-Line Technologies, Inc. v. Bodenseewerk Perkin-Elmer GmbH, 386 F.3d 1133 (Fed. Cir. 2004), 5-60
- One StockDuq Holdings, LLC v. Becton, Dickinson & Co., 2013 U.S. Dist. LEXIS 36621, 2013 WL 1136726 (W.D. Tenn. May 6, 2013), 2-57
- Open Text S.A. v. Box, Inc., 2015 U.S. Dist. LEXIS 8783, 2015 WL 393858 (N.D. Cal. Jan. 29, 2015), 7-33
- OpenWave Systems, Inc. v. Apple Inc., 808 F.3d 509 (Fed. Cir. 2015), 5-66, 5-67
- Oplus Technologies, Ltd. v. Vizio, Inc., 782 F.3d 1371 (Fed. Cir. 2015), 9-12
- Oracle America, Inc. v. Google Inc., 798 F. Supp. 2d 1111 (N.D. Cal. 2011), 2-81, 6-43
- Oracle America, Inc. v. Google Inc., 2012 U.S. Dist. LEXIS 132696, 2012 WL 4017808 (N.D. Cal. Apr. 10, 2012), 2-82
- Oracle America, Inc. v. Google, Inc., 2012 U.S. Dist. LEXIS 33619, 2012 WL 850705 (N.D. Cal. Mar. 13, 2012), 7-38, 8-38-8-39, 14-109
- Organic Seed Growers & Trade Ass'n v. Monsanto Co., 718 F.3d 1350 (Fed. Cir. 2013), 2-32
- Orion IP, LLC v. Hyundai Motor Am., 605 F.3d 967 (Fed. Cir. 2010), 6-5, 6-7, 8-40, 8-41
- Orion IP, LLC v. Mercedes-Benz USA, LLC, 2008 U.S. Dist. LEXIS 108683, 2008 WL 8856865 (E.D. Tex. Mar. 28, 2008), 9-8
- Ormco Corp. v. Align Tech., Inc., 463 F.3d 1299 (Fed. Cir. 2006), 5-61, 7-11
- Ormco Corp. v. Align Tech., Inc., 498 F.3d 1307 (Fed. Cir. 2007), 9-22
- Ortho-McNeil Pharmaceutical, Inc. v. Caraco Pharm. Labs., Ltd., 476 F.3d 1321 (Fed. Cir. 2007), 5-42, 5-47, 5-51
- Ortho-McNeil Pharmaceutical, Inc. v. Mylan Labs, Inc., 520 F.3d 1358 (Fed. Cir. 2008), 6-8, 14-74

Patent Case Management Judicial Guide, Third Edition

Otsuka Pharmaceutical Co. v. Mylan, Inc., No. Civ.A. 14-4508 JBS, 2015 WL 1305764 (D.N.J. Mar. 23, 2015), 10-11

Outlast Technologies, Inc. v. Frisby Techs., Inc., 298 F. Supp. 2d 1112 (D. Colo. 2004), 2-47

Owens, *In re*, 710 F.3d 1362 (Fed. Cir. 2013), 11-4

Oxley v. Penobscot County, No. CV-09-21-JAW, 2010 WL 3154975 (D. Me. 2010), 4-35

P.A.T., Co. v. Ultrak, Inc., 948 F. Supp. 1518 (D. Kan. 1996), 5-91

P.N.A. Construction Techs. v. McTech Grp., Inc., 414 F. Supp. 2d 1228 (N.D. Ga. 2006), 3-12

Pacific Coast Marine Windshields Ltd. v. Malibu Boats, LLC, 739 F.3d 694 (Fed. Cir. 2014), 11-9

Pacing Technologies, LLC v. Garmin Int'l, Inc., 778 F.3d 1021 (Fed. Cir. 2015), 5-60, 5-61, 5-64, 5-71

Paice LLC v. Toyota Motor Corp., 2006 WL 2385139, 2006 U.S. Dist. LEXIS 61600 (E.D. Tex. Aug. 16, 2006), 3-13

Paice LLC v. Toyota Motor Corp., 504 F.3d 1293 (Fed. Cir. 2007), 9-6, 9-7

Pall Corp. v. Hemasure Inc., 181 F.3d 1305 (Fed. Cir. 1999), 5-23

Pall Corp. v. Micron Separations, Inc., 66 F.3d 1211 (Fed. Cir. 1995), 7-17

Palumbo v. Don-Joy Co., 762 F.2d 969 (Fed. Cir. 1985), 5-81

Pandora Jewelry, LLC v. Chamilia, LLC, No. CCB-06-3041, 2008 WL 4533902 (D. Md. Sept. 30, 2008), 4-38

Pandrol USA, LP v. Airboss Railway Prods., Inc., 320 F.3d 1354 (Fed. Cir. 2003), 2-29

Pandrol USA, LP v. Airboss Railway Prods., Inc., 424 F.3d 1161 (Fed. Cir. 2005), 2-35

Panduit Corp. v. Hellermanntyton Corp., 451 F.3d 819 (Fed. Cir. 2006), 14-84

Panduit Corp. v. Stahlin Bros. Fibre Works, Inc., 575 F.2d 1152 (6th Cir. 1978), 7-18, 8-33, 13-9, 14-104

Paone v. Microsoft Corp., 771 F. Supp. 2d 224 (E.D.N.Y. 2011), 5-20

Paragon Podiatry Lab., Inc. v. KLM Labs., Inc., 984 F.2d 1182 (Fed. Cir. 1993), 8-5

Paragon Solutions, LLC v. Timex Corp., 566 F.3d 1075 (Fed. Cir. 2009), 5-52

Parallel Networks v. AEO, Inc., No. 6:20cv275-LED-JDL (E.D. Tex. Mar. 15, 2011), 2-25

Paramount Pictures, Inc. v. Rodney, 186 F.2d 111 (3d Cir. 1950), 2-61

Parke-Davis & Co. v. H.K. Mulford & Co., 189 F. 95 (S.D.N.Y. 1911), *aff'd*, 196 F. 496 (2d Cir. 1912), 14-43

Parker v. Flook, 437 U.S. 584 (1978), 14-36, 14-37, 14-41

Patlex Corp. v. Mossinghoff, 758 F.2d 594 (Fed. Cir. 1985), 2-55

Paulik v. Rizkalla, 760 F.2d 1270 (Fed. Cir. 1985), 14-56

Paulsen, *In re*, 30 F.3d 1475 (Fed. Cir. 1994), 14-68

Payne v. Tenn., 501 U.S. 808 (1991), 5-100

PC Connector Solutions LLC v. SmartDisk Corp., 406 F.3d 1359 (Fed. Cir. 2005), 5-76

Peeler v. Miller, 535 F.2d 647 (C.C.P.A. 1976), 14-56

Pellegrini v. Analog Devices, Inc., 275 F.3d 1113 (Fed. Cir. 2004), 14-88

Penalty Kick Mgmt. Ltd. v. Coca Cola Co., 318 F.3d 1284 (11th Cir. 2003), 4-45

Penda Corp. v. United States, 44 F.3d 967 (Fed. Cir. 1994), 13-8

Pennington Seed, Inc., *In re*, 466 F.3d 1053 (Fed. Cir. 2006), 12-13

Pennock v. Dialogue, 27 U.S. 1 (1829), 1-6

Pennwalt Corp. v. Durand-Wayland, 833 F.2d 931 (Fed. Cir. 1987), 6-9

People, Inc. v. Medeco Sec. Locks, Inc., 59 F. Supp. 2d 1040 (N.D. Cal. 1999), 5-93

Perfect Web Techs. v. InfoUSA Inc., 587 F.3d 1324 (Fed. Cir. 2009), 5-30, 14-75

Table of Cases

Pergo, Inc. v. Faus Group, Inc., 401 F. Supp. 2d 515 (E.D.N.C. 2005), 3-17

PerSeptive BioSystems, Inc. v. Pharmacia Biotech, Inc., 12 F. Supp. 2d 69 (D. Mass. 1998), *aff'd*, 225 F.3d 1315 (Fed. Cir. 2000), 8-25

PersonalWeb Techs., LLC v. Facebook, Inc., 2014 U.S. Dist. LEXIS 4095, 2014 WL 116340 (N.D. Cal. Jan. 13, 2014), 5-27

Petrella v. Metro-Goldwyn-Mayer, Inc., 134 S. Ct. 1962 (2014), 14-96

Pfaff v. Wells Elecs., 525 U.S. 55 (1998), 14-59

Pfizer v. Apotex, Inc. 726 F. Supp. 921 (N.D. Ill. 2010), 2-44

Pfizer, Inc. v. Ranbaxy Labs., Ltd., 457 F.3d 1284 (Fed. Cir. 2006), 5-39

Pfizer, Inc. v. Teva Pharms., USA, Inc., 429 F.3d 1364 (Fed. Cir. 2005), 3-12, 5-95

Pharmacia & Upjohn Co. v. Mylan Pharm., Inc., 170 F.3d 1373 (Fed. Cir. 1999), 5-80

PharmaStem Therapeutics, Inc. v. ViaCell, Inc., 491 F.3d 1342 (Fed. Cir. 2007), 6-16, 6-27, 7-11, 14-70, 14-75

PHG Technologies, LLC v. St. John Cos., 469 F.3d 1361 (Fed. Cir. 2006), 11-10, 11-11

Philip M. Adams & Assocs., LLC v. Dell Inc., 2010 U.S. Dist. LEXIS 68749, 2010 WL 2733319 (D. Utah 2010), 5-20

Phillips v. AWH Corp., 415 F.3d 1303 (Fed. Cir. 2005), 2-20, 5-33, 5-36, 5-37, 5-39, 5-40, 5-53–5-59, 5-62, 5-63, 5-65, 5-66, 5-68, 5-69, 5-78, 5-79, 5-103, 5-104, 14-15, 14-81

Phonometrics, Inc. v. Economy Inns of Am., 349 F.3d 1356 (Fed. Cir. 2003), 5-99

Phonometrics, Inc. v. N. Telecom Inc., 133 F.3d 1459 (Fed. Cir. 1998), 5-96

Phonometrics, Inc. v. Westin Hotel Co., 350 F.3d 1242 (Fed. Cir. 2003), 5-99

Piecznik v. Dyax Corp., 76 F. App'x 293 (Fed. Cir. 2003), 5-74

Pinstripe, Inc. v. Manpower, Inc., No. 07-CV-620-GKF-PJC, 2009WL 2252131 (N.D. Okla. July 29, 2009), 4-44

Pipes v. UPS, Inc., No. CIV.A.07-1762, 2009 WL 2214990 (W.D. La. July 22, 2009), 4-44

Pitney Bowes, Inc. v. Hewlett-Packard Co., 182 F.3d 1298 (Fed. Cir. 1999), 5-71

Planet Bingo, LLC v. Gametech International, Inc., 472 F.3d 1338 (Fed. Cir. 2006), 6-11

Plant Genetic Systems, N.V. v. DeKalb Genetics Corp., 315 F.3d 1335 (Fed. Cir. 2003), 14-49

Plantronics, Inc. v. Aliph, Inc., 724 F.3d 1343 (Fed. Cir. 2013), 5-58, 5-103, 6-33

Playtex Products, Inc. v. Procter & Gamble Co., 400 F.3d 901 (Fed. Cir. 2005), 5-50

Plymouth Industries, LLC v. Sioux Steel Co., No. 8:05CV196, 8:05CV469, 2006 WL 695458, 2006 U.S. Dist. LEXIS 14706 (D. Neb. Mar. 17, 2006), 4-29

PODS, Inc. v. Porta Stor, Inc., 484 F.3d 1359 (Fed. Cir. 2007), 7-49

Polaroid Corp. v. Eastman Kodak Co., 641 F. Supp. 828 (D. Mass. 1985), *aff'd*, 833 F.2d 930 (Fed. Cir. 1986), 9-20

Polymer Technologies, Inc. v. Bridwell, 103 F.3d 970 (Fed. Cir. 1996), 3-7, 3-9

Portney v. CIBA Vision Corp., 401 F. App'x 526 (Fed. Cir. 2010), 5-32

Power Integrations, Inc. v. BCD Semiconductor Corp., C.A. No. 07-633-JJF-LPS, 2008 WL 496446, 2008 U.S. Dist. LEXIS 16021 (D. Del. Feb. 11, 2008), 3-22

Power Survey, LLC v. Premier Utility Services, LLC, No. 13-5670, 2015 WL 687716, 2015 U.S. Dist. LEXIS 19139 (D.N.J. Feb. 18, 2015), 3-18

Power-One, Inc. v. Artesyn Techs., Inc., Civ. Action No. 2:05-CV-463, 2008 WL 1746636, 2008 U.S. Dist. LEXIS 30338 (E.D. Tex. Apr. 11, 2008), 3-28

PPG Industries v. Guardian Indus. Corp., 156 F.3d 1351 (Fed. Cir. 1998), 5-24, 5-50, 5-75

Patent Case Management Judicial Guide, Third Edition

Pradaxa (Dabigatran Etexilate) Prods. Liab. Litig., *In re*, MDL No. 2385, 3:12-md-02385-DRH-SCW, 2013 U.S. Dist. LEXIS 137235, 2013 WL 5377164 (S.D. Ill. Sept. 25, 2013), 4-21

Pragmatus AV, LLC v. Facebook, Inc., 769 F. Supp. 2d 991 (E.D. Va. 2011), 2-63

Praxair, Inc. v. ATMI, Inc., 479 F. Supp. 2d 440 (D. Del. 2007), 9-4

Precision Instrument Mfg. Co. v. Automotive Maint. Mach. Co., 324 U.S. 806 (1945), 1-8

Presidio Components, Inc. v. Am. Tech. Ceramics Corp., 2010 U.S. Dist. LEXIS 79039, 2010 WL 3070370 (S.D. Cal. Aug. 5, 2010), 9-8

Presidio Components, Inc. v. Am. Tech. Ceramics Corp., 702 F.3d 1351 (Fed. Cir. 2012), 3-8, 9-3

Pressure Products Medical Supplies, Inc. v. Greatbatch Ltd., 599 F.3d 1308 (Fed. Cir. 2010), 5-12

Pretty Punch Shoppettes, Inc. v. Hauk, 844 F.2d 782 (Fed. Cir. 1988), 3-7

Prima Tek II, L.L.C. v. A-Roo Co., 222 F.3d 1372 (Fed. Cir. 2000), 2-29

Princo Corp., *In re*, 478 F.3d 1345 (Fed. Cir. 2007), 2-48

Procaps S.A. v. Patheon, Inc., No. 12-24356-CIV, 2014 U.S. Dist. LEXIS 35225, 2014 WL 1047748 (S.D. Fla. Mar. 18, 2014), 4-21

Procter & Gamble Co. v. Haugen, 427 F.3d 727 (10th Cir. 2005), 4-44

Procter & Gamble Co. v. Teva Pharm. USA, Inc., 566 F.3d 989 (Fed. Cir. 2009), 14-73

Professional Real Estate Investors, Inc. v. Columbia Pictures, Inc., 508 U.S. 49 (1993), 4-28

Progressive Casualty Ins. Co. v. Safeco Ins. Co., 2013 U.S. Dist. LEXIS 54899, 2013 WL 1662952 (N.D. Ohio Apr. 17, 2013), 2-57

Proofpoint, Inc. v. InNova Patent Licensing, LLC, 2011 U.S. Dist. LEXIS 120343, 2011 WL 4915847 (N.D. Cal. Oct. 17, 2011), 2-73

Propat International Corp. v. RPost US, Inc., 473 F.3d 1187 (Fed. Cir. 2007), 2-29, 2-30, 2-31, 2-32

Protegrity Corp., *In re*, 2015 U.S. Dist. LEXIS 14291, 2015 WL 506373 (MDL No. 2600, Feb. 6, 2015), 5-27

Proveris Scientific Corp. v. Innovasystems, Inc., 739 F.3d 1367 (Fed. Cir. 2014), 9-8

PSC Computer Products, Inc. v. Foxconn Int'l, Inc., 355 F.3d 1353 (Fed. Cir. 2004), 14-86

Pughsley v. 3750 Lake Shore Drive Coop. Bldg., 463 F.2d 1055 (7th Cir. 1972), 3-25

Purdue Pharma L.P. v. Boehringer Ingelheim GmbH, 237 F.3d 1359 (Fed. Cir. 2001), 3-10, 3-16, 14-102

Purdue Pharma L.P. v. Endo Pharm. Inc., 410 F.3d 690 (Fed. Cir. 2005), 14-93

Purdue Pharma L.P. v. Endo Pharm. Inc., 438 F.3d 1123 (Fed. Cir. 2006), 5-68

Pure Fishing, Inc. v. Normack Corp., 10-cv-2140, 2014 U.S. Dist. LEXIS 153272, 2014 WL 5474589 (D.S.C. Oct. 28, 2014), 9-14

Q-Pharma, Inc. v. Andrew Jergens Co., 360 F.3d 1295 (Fed. Cir. 2004), 2-58

Quackenbush v. Allstate Ins. Co., 517 U.S. 706 (1996), 2-61

Quaker City Gear Works, Inc. v. Skil Corp., 747 F.2d 1446 (Fed. Cir. 1984), 6-8

Qualcomm Inc. v. Broadcom Corp., 548 F.3d 1004 (Fed. Cir. 2008), 2-72

Quanta Computers, Inc. v. LG Electronics, Inc., 553 U.S. 617 (2008), 14-90

Quanta v. LG Electronics, 128 S. Ct. 2109 (2008), 5-68

Quantum Corp. v. Rodime, PLC, 65 F.3d 1577 (Fed. Cir. 1995), 14-24

Quantum Corp. v. Tandon Corp., 940 F.2d 642 (Fed. Cir. 1991), 4-30

Raab v. Casper, 51 Cal. App. 3d 866 (1975), 3-2

Rajala v. McGuire Woods, LLP, No. 08-2638-CM-DJW, 2010 WL 2949582 (D. Kan. July 22, 2010), 4-75

Rambus Inc. v. Hynix Semiconductor Inc., 569 F. Supp. 2d 946 (N.D. Cal. 2008), 5-88, 5-100

Rambus Inc. v. Infineon Techs. AG, 318 F.3d 1081 (Fed. Cir. 2003), 6-8

Table of Cases

Rasmusson v. Smithkline Beecham Corp., 413 F.3d 1318 (Fed. Cir. 2005), 14-49

Rates Technology, Inc. v. Cablevision Systems Corp., No. CV 05-3583 DRH WDW, 2006 WL 1026044, 2006 U.S. Dist. LEXIS 19668 (E.D.N.Y. Apr. 14, 2006), 4-31

Razor USA LLC v. ASA Prods., Inc., Nos. 01-1080, 2000 WL 1819400, 2000 U.S. App. LEXIS 33182 (Fed. Cir. Nov. 22, 2000), 3-29, 3-30

RE2CON, LLC v. Telfer Oil Co., 2013 U.S. Dist. LEXIS 46192, 2013 WL 1325183 (E.D. Cal. 2013), 5-101

Read Corp. v. Portec, Inc., 970 F.2d 816 (Fed. Cir. 1992), 9-10, 14-111

Red Wing Shoe Co. v. Hockerson-Halberstadt, Inc., 148 F.3d 1355 (Fed. Cir. 1998), 10-14

Reebok Int'l Ltd. v. J. Baker, Inc., 32 F.3d 1552 (Fed. Cir. 1994), 3-7

Refac Int'l Ltd. v. Hitachi Ltd., 141 F.R.D. 281 (C.D. Cal. 1991), 2-58

Refac Int'l, Ltd. v. IBM, 790 F.2d 79 (Fed. Cir. 1986), 2-37

Regeneron Pharm., Inc. v. Merus B.V., 2014 U.S. Dist. LEXIS 84297, 2014 WL 2795461 (S.D.N.Y. June 19, 2014), 2-41

Regents of the University of California v. Dako N. Am., Inc., 477 F.3d 1335 (Fed. Cir. 2007), 14-116

Regents of the University of California v. DakoCytomation Cal., Inc., 517 F.3d 1364 (Fed. Cir. 2008), 5-32, 5-71

Regents of the University of California v. Eli Lilly & Co., 119 F.3d 1559 (Fed. Cir. 1997), 14-48

Regents of the University of California v. Oncor Inc., No. C-95-3084-VRW, 1997 U.S. Dist. LEXIS 15068, 1997 WL 670674 (N.D. Cal. Aug. 19, 1997), 8-22

Reilly v. United States, 863 F.2d 149 (1st Cir. 1988), 8-23

Rembrandt Wireless Techs., LP v. Samsung Elecs. Co., Ltd., 2015 U.S. Dist. LEXIS 20306, 2015 WL 627430 (E.D. Tex. Jan. 30, 2015), 7-54

Renishaw PLC v. Marposs Societa' per Azioni, 158 F.3d 1243 (Fed. Cir. 1998), 5-50

Residential Funding Corp. v. DeGeorge Fin. Corp., 306 F.3d 99 (2d Cir. 2002), 4-36

ResQNet.com, Inc. v. Lansa, Inc., 346 F.3d 1374 (Fed. Cir. 2003), 5-38

ResQNet.com, Inc. v. Lansa, Inc., 533 F. Supp. 2d 397 (S.D.N.Y. Feb. 1, 2008), 8-27

ResQNet.com, Inc. v. Lansa, Inc., 594 F.3d 860 (Fed. Cir. 2010), 4-32, 6-7, 7-33, 8-37, 8-38, 14-106, 14-108

Retractable Technologies, Inc. v. Becton, Dickinson & Co., 653 F.3d 1296 (Fed. Cir. 2011), 5-59, 5-66, 5-71

Retractable Technologies, Inc. v. Becton, Dickinson & Co., 659 F.3d 1369 (Fed. Cir. 2011), 5-59

Revision Military, Inc. v. Balboa Mfg. Co., 700 F.3d 524 (Fed. Cir. 2012), 3-7

Rexnord Corp. v. Laitrop Corp., 274 F.3d 1336 (Fed. Cir. 2001), 5-63

RF Delaware, Inc. v. Pac. Keystone Techs., Inc., 326 F.3d 1255 (Fed. Cir. 2003), 5-69, 5-91, 5-95, 5-97, 5-98

Rhino Ass'n, L.P. v. Berg Mfg. & Sales Corp., Civil Action No. 1:04-CV-1611 (M.D. Pa. July 1, 2005), 3-19

Rhone-Poulenc Rorer, *In re*, 48 U.S.P.Q.2D (BNA) 1823, 1998 U.S. App. LEXIS 12829 (Fed. Cir. 1998), 2-45

Richardson v. Stanley Works, 597 F.3d 1288 (Fed. Cir. 2010), 11-7, 11-8, 11-9, 11-10

Richardson-Vicks Inc. v. Upjohn Co., 122 F.3d 1476 (Fed. Cir. 1997), 7-10, 8-43

Riles v. Amerada Hess Corp., 999 F. Supp. 938 (S.D. Tex. 1998), 13-5

Riles v. Shell Exploration & Prod. Co., 298 F.3d 1302 (Fed. Cir. 2002), 7-22, 9-11

Rimkus Consulting Grp., Inc. v. Cammarata, 688 F. Supp. 2d 598 (S.D. Tex. 2010), 4-39

Rite-Hite Corp. v. Kelley Co., 56 F.3d 1538 (Fed. Cir. 1995), 3-15, 6-6, 7-18, 7-32, 8-33, 8-36, 14-104, 14-105, 14-106

Rival Co. v. Sunbeam Corp., 185 F.3d 885 (Fed. Cir. 1999), 5-76

Patent Case Management Judicial Guide, Third Edition

Robert Bosch LLC v. Pylon Mfg. Corp., 659 F.3d 1142 (Fed. Cir. 2011), 3-11, 3-12, 9-2, 9-3, 9-4, 14-103
Robert Bosch LLC v. Snap-On Inc., No. 12-cv-11503 (E.D. Mich. Sept. 25, 2014), 6-35, 9-16
Robert Bosch, LLC v. Pylon Mfg. Corp., 719 F.3d 1305 (Fed. Cir. 2013), 8-7
Roberts v. Sears, Roebuck & Co., 573 F.2d 976 (7th Cir. 1978), 14-100
Robinson v. Bartlow, No. 12-cv-24, 2014 U.S. Dist. LEXIS 75105, 2014 WL 2468817 (W.D. Va. June 3, 2014), 9-15
Robotic Vision Systems v. View Eng'g, No. CV 95-7441 LGB (AJWx), 1996 WL 383900, 1996 U.S. Dist. LEXIS 11917 (C.D. Cal. Mar. 1, 1996), 3-20
Robotic Vision Systems, Inc. v. View Eng'g, 112 F.3d 1163 (Fed. Cir. 1997), 3-20
Robotic Vision Systems, Inc. v. View Eng'g, Inc., 249 F.3d 1307 (Fed. Cir. 2001), 6-7
Roche Palo Alto LLC v. Apotex, Inc., 531 F.3d 1372 (Fed. Cir. 2008), 14-88
Roche Products Inc. v. Bolar Pharm. Co., 733 F.2d 858 (Fed. Cir. 1984), 14-91
Roland Machinery Co. v. Dresser Indus., Inc., 749 F.2d 380 (7th Cir. 1984), 3-30
Rolls-Royce Ltd. v. United States, 364 F.2d 415 (Ct. Cl. 1966), 13-8
Rolls-Royce, PLC v. United Techs. Corp., 603 F.3d 1325 (Fed. Cir. 2010), 14-75
Romag Fasteners, Inc. v. Fossil, Inc., No. 10-cv-1827, 2014 U.S. Dist. LEXIS 113061, 2014 WL 4073204 (D. Conn. Aug. 14, 2014), 9-12
Rosco, Inc. v. Mirror Lite Co., 304 F.3d 1373 (Fed. Cir. 2002), 11-10–11-11
Rosen Entertainment Systems, LP v. Icon Enters., Inc., 359 F. Supp. 2d 902 (C.D. Cal. 2005), 14-67
Rosenthal v. Stein, 205 F.2d 633 (9th Cir. 1953), 11-6
Rothman v. Target Corp., 556 F.3d 1310 (Fed. Cir. 2009), 6-33, 7-11
Rowe Int'l Corp. v. Ecast, Inc., 241 F.R.D. 296 (N.D. Ill. 2007), 4-29
Rubenfield, *In re*, 270 F.2d 391 (C.C.P.A. 1959), 11-4
Ryan Operations G.P. v. Santiam-Midwest Lumber Co., 81 F.3d 355 (3d Cir. 1996), 5-97
S.C. Johnson & Son, Inc. v. Carter-Wallace, Inc., 781 F.2d 198 (Fed. Cir. 1986), 9-12
SAES Getters S.p.A. v. Aeronex, Inc., 219 F. Supp. 2d 1081 (S.D. Cal. 2002), 2-52
Salesforce v. VirtualAgility, CBM 2013-00024, Paper No. 16 (P.T.A.B. Nov. 19, 2013), 2-57
Sampson v. City of Cambridge, No. WDQ-06-1819, 2008 WL 7514364 (D. Md. May 1, 2008), 4-38
SanDisk Corp. v. Memorex Prods., Inc., 415 F.3d 1278 (Fed. Cir. 2005), 5-68
SanDisk Corp. v. STMicroelectronics, Inc., 480 F.3d 1372 (Fed. Cir. 2007), 2-34
Sandoz Inc. v. Amgen Inc., 2013 WL 6000069 (N.D. Cal. Nov. 12, 2013), 10-32, 10-34
Sandoz Inc. v. Amgen Inc., 773 F.3d 1274 (Fed. Cir. 2014), 10-33
Sanitary Refrigerator Co. v. Winters, 280 U.S. 30 (1929), 14-82
Sanofi-Aventis Deutschland GmbH v. Novo Nordisk, Inc., 614 F. Supp. 2d 772 (E.D. Tex. 2009), 2-51
Sanofi-Aventis LLC v. Sandoz, Inc., 345 F. App'x 594 (Fed. Cir. 2009), 10-16
Sanofi-Synthelabo v. Apotex Inc., 294 F. Supp. 2d 353 (S.D.N.Y. 2007), *aff'd*, 5590 F.3d 1075 (Fed. Cir. 2008), *cert. denied*, 130 S. Ct. 493 (2009), 10-16, 14-74
Sanofi-Synthelabo v. Apotex, Inc., 470 F.3d 1368 (Fed. Cir. 2006), 3-9, 3-11, 3-15, 3-26, 3-29
SCA Hygiene Aktiebolag v. First Quality Baby Products, LLC, No. 13-1564, 2014 U.S. App. LEXIS 24697, 2014 WL 7460970 (Fed. Cir. Dec. 30, 2014), 6-4
SCA Hygiene Products Aktiebolag v. First Quality Baby Products, LLC, 807 F.3d 1311 (Fed. Cir. 2015), 14-96
Scheinman v. Zalkind, 112 F.2d 1017 (C.C.P.A. 1940), 5-77

Table of Cases

Schering Corp. v. Amgen, Inc., 35 F. Supp. 2d 375 (D. Del. 1999), 5-96
Schering Corp. v. Geneva Pharm., Inc., 339 F.3d 1373 (Fed. Cir. 2003), 14-52
Schering Corp. v. Roussel-UCLAF SA, 104 F.3d 341 (Fed. Cir. 1997), 2-30
Schering-Plough Corp. v. FTC, 402 F.3d 1056 (11th Cir. 2005), 2-91, 10-20
Schering-Plough Corp., *In re*, 136 F.T.C. 956 (2003), 10-20
Schillinger v. United States, 155 U.S. 163 (1894), 13-1, 13-3
Schnadig Corp. v. Collezione Europa U.S.A., 2001 U.S. Dist. LEXIS 9208, 2001 WL 766898 (N.D. Ill. July 3, 2001), 2-52
Schnadig Corp. v. Gaines Mfg. Co., 620 F.2d 1166 (6th Cir. 1980), 11-14
Schnell, *In re*, 46 F.2d 203 (C.C.P.A. 1931), 11-5
Schoenhaus v. Genesco, Inc., 440 F.3d 1354 (Fed. Cir. 2006), 6-11
Schrieber v. Federal Express Corp., No. 09-CV-128-JHPPJC, 2010 WL 1078463 (N.D. Okla. Mar. 18, 2010), 4-44
Schroeder v. Tracor, Inc., No. 99-1281, 1999 U.S. App. LEXIS 30386, 1999 WL 1021055 (Fed. Cir. Nov. 5, 1999), 14-91
Sciele Pharma Inc. v. Lupin Ltd., 684 F.3d 1253 (Fed. Cir. 2012), 3-10, 3-16
SciMed Life Systems, Inc. v. Advanced Cardiovascular Systems, Inc., 242 F.3d 1337 (Fed. Cir. 2001), 5-60, 14-85
Scripps Clinic & Research Foundation v. Genentech, Inc., 927 F.2d 1565 (Fed. Cir. 1991), 5-82, 6-12, 7-51, 14-87
Seaborg, *In re*, 328 F.2d 996 (C.C.P.A. 1964), 14-52
Seachange Int'l, Inc. v. C-COR, Inc., 413 F.3d 1361 (Fed. Cir. 2005), 5-70
Seagate Tech., LLC, *In re*, 497 F.3d 1360 (Fed. Cir. 2007), 1-10, 2-43, 3-6, 3-10, 4-28, 6-45, 7-14, 7-56, 9-10, 14-111, 14-112
Sears Petroleum & Transp. Corp. v. Archer Daniels Midland Co., 2007 U.S. Dist. LEXIS 53576, 2007 WL 2156251 (N.D.N.Y. July 24, 2007), 5-100
Sears, Roebuck & Company v. Stiffel Company, 376 U.S. 225 (1964), 14-99
Seattle Box Co. v. Industrial Crating & Packing, Inc., 756 F.2d 1574 (Fed. Cir. 1985), 14-22
Seattle Box Co., Inc. v. Indus. Crating & Packing, Inc., 731 F.2d 818 (Fed. Cir. 1984), 5-49
SEB S.A. v. Montgomery Ward & Co., 137 F. Supp. 2d 285 (S.D.N.Y. 2001), 3-28
Seiko Epson Corp. v. Nu-Kote Int'l, Inc., 190 F.3d 1360 (Fed. Cir. 1999), 2-47, 11-10
Sekisui Am. Corp. v. Hart, No. 12 Civ. 3479 (SAS) (FM), 2013 WL 4116322 (S.D.N.Y. Aug. 15, 2013), 4-20
Semiconductor Energy Lab. Co. v. Chimei Innolux Corp., 2012 U.S. Dist. LEXIS 186322, 2012 WL 7170593 (C.D. Cal. Dec. 19, 2012), 2-56
Semiconductor Energy Laboratory Co. v. Nagata, 706 F.3d 1365 (Fed. Cir. 2013), 2-35
Semitool, Inc. v. Tokyo Elec. Am., 208 F.R.D. 273 (N.D. Cal. 2002), 3-21
Senior Technologies, Inc. v. R.F. Techs. Inc., 76 F. App'x 318 (Fed. Cir. 2003), 14-85
Senju Pharmaceuticals Co. v. Metrics, Inc., Civ. No. 14-3962 (JBS/KMW), 2015 WL 1472123 (D.N.J. Mar. 31, 2015), 10-11
Serco Services Co., L.P. v. Kelley Co., Inc., 51 F.3d 1037 (Fed. Cir. 1995), 2-52
Serio-US Indus., Inc. v. Plastic Recovery Techs. Corp., 459 F.3d 1311 (Fed. Cir. 2006), 8-17, 9-17
Seymore v. McCormick, 57 U.S. 480 (1853), 7-21, 14-107
SFA Systems, LLC v. 1-800-Flowers.com, Inc., No. 09-cv-340, 2014 U.S. Dist. LEXIS 184311 (E.D. Tex. July 7, 2014), 9-15

Patent Case Management Judicial Guide, Third Edition

Shamrock Technologies, Inc. v. Med. Sterilization, Inc., 903 F.2d 789 (Fed. Cir. 1990), 2-35, 2-36, 14-99
Sheldone v. Pa. Tpk. Comm'n, 104 F. Supp. 2d 511 (W.D. Pa. 2000), 2-87
Shepherd v. Am. Broad Cos., 62 F.3d 1469 (D.C. Cir. 1995), 4-46
Shum v. Intel, 499 F.3d 1272 (Fed. Cir. 2007), 8-5
Sibia Neurosciences, Inc. v. Cadus Pharm. Corp., 225 F.3d 1349 (Fed. Cir. 2000), 6-8
Silent Drive, Inc. v. Strong Indus., Inc., 326 F.3d 1194 (Fed. Cir. 2003), 2-59
Silicon Graphics, Inc. v. ATI Techs., Inc., 607 F.3d 784 (Fed. Cir. 2010), 5-30
Silvestri v. General Motors Corp., 271 F.3d 583 (4th Cir. 2001), 4-20, 4-38
Sinclair Refining Co. v. Jenkins Petroleum Co., 289 U.S. 689 (1933), 7-35
Site Update Solutions LLC v. Accor North America Inc., No. 11-cv-03306, 2015 U.S. Dist. LEXIS 17603, 2015 WL 581175 (N.D. Cal. Feb. 11, 2015), 9-15
SKF Condition Monitoring, Inc. v. Invensys Systems Inc., 07-CV-1116 BTM (NLS), 2010 U.S. Dist. LEXIS 35130, 2010 WL 3463686 (S.D. Cal. Apr. 9, 2010), 4-22
SkinMedica, Inc. v. Histogen Inc., 727 F.3d 1187 (Fed. Cir. 2013), 5-43
Small v. University Medical Center of S. Nevada, Case No. 2:13-cv-00298-APG-PAL, 2014 WL 4079507, 2014 U.S. Dist. LEXIS 114406 (D. Nev. Aug. 18, 2014), 4-22
Smith, *In re*, 714 F.2d 1127 (Fed. Cir. 1983), 14-58
Smith & Nephew Inc. v. Arthrex Inc., 355 F. App'x 384 (Fed. Cir. 2009), 5-29
Smith Int'l v. Hughes Tool Co., 718 F.2d 1573 (Fed. Cir. 1983), 3-5, 3-8, 14-101
Smith Int'l v. Hughes Tool Co., 759 F.2d 1572 (Fed. Cir. 1985), 9-22
Smith v. Slifer Smith & Frampton/Vail Assocs. Real Estate, LLC, No. CIVA 06CV02206-JLK, 2009 WL 482603 (D. Colo. Feb. 25, 2009), 4-44
Societe Internationale v. Rogers, 357 U.S. 197 (1958), 4-44
Société Nationale Industrielle Aérospatiale v. United States Dist. Ct., 482 U.S. 522 (1987), 4-14
Sofamor Danek Grp., Inc. v. DePuy-Motech, Inc., 74 F.3d 1216 (Fed. Cir. 1996), 2-25
Solaia Technology LLC v. Jefferson Smurfit Corp., 2002 WL 1964761, 2002 U.S. Dist. LEXIS 15666 (N.D. Ill. Aug. 20, 2002), 2-6
Solvay S.A. v. Honeywell Int'l, Inc., 622 F.3d 1367 (Fed. Cir. 2010), 6-8
Southwest Software, Inc. v. Harlequin, Inc., 226 F.3d 1280 (Fed. Cir. 2000), 8-41, 14-19
Soverain Software LLC v. Amazon.com, Inc., 383 F. Supp. 2d 904 (E.D. Tex. 2005), 14-111
Spalding Sports Worldwide, Inc., *In re*, 203 F.3d 800 (Fed. Cir. 2000), 2-15, 4-29
Spansion, Inc. v. Int'l Trade Comm'n, 629 F.3d 1331 (Fed. Cir. 2010), 1-14, 2-48
Specht v. Google, Inc., 758 F. Supp. 2d 570 (2010), 8-27
Spectra-Physics Lasers, Inc. v. Uniphase Corp., 144 F.R.D. 99 (N.D. Cal. 1992), 8-3
Spectra-Physics, Inc. v. Coherent, Inc., 827 F.3d 1524 (Fed. Cir. 1987), 7-43
Spindelfabrik Suessen-Schurr v. Schubert & Salzer Maschinenfabrik Aktiengesellschaft, 903 F.2d 1568 (Fed. Cir. 1990), 3-28
SRAM Corp. v. AD-II Eng'g, Inc., 465 F.3d 1351 (Fed. Cir. 2006), 5-69
SRI Int'l v. Advanced Tech. Labs., Inc., 127 F.3d 1462 (Fed. Cir. 1997), 9-11
SRI Int'l v. Matsushita Elec. Corp. of Am., 775 F.2d 1107 (Fed. Cir. 1985) (en banc), 2-21, 5-23, 6-6, 14-88
St. Clair Intellectual Prop. Consultants, Inc. v. Nokia Corp., 395 F. App'x 707 (Fed. Cir. 2010), 5-32
Stamps.com Inc. v. Endicia, Inc., 437 F. App'x 897 (Fed. Cir. 2011), 2-12
Standard Havens Prods., Inc. v. Gencor Indus., Inc., 897 F.2d 511 (Fed. Cir. 1990), 3-30, 9-20

Table of Cases

Standard Havens Prods., Inc. v. Gencor Indus., Inc., 953 F.2d 1360 (Fed. Cir. 1991), 8-34
Star Scientific, Inc. v. R.J. Reynolds Tobacco Co., 537 F.3d 1357 (Fed. Cir. 2008), 14-94
Starhome GmbH v. AT&T Mobility LLC, 743 F.3d 849 (Fed. Cir. 2014), 5-38, 5-58, 5-103
Stark v. Advanced Magnetics, Inc., 119 F.3d 1551 (Fed. Cir. 1997), 14-76
State Industries, Inc. v. Mor-Flo Indus., Inc., 883 F.2d 1573 (Fed. Cir. 1989), 7-18
State Street Bank & Tr. Co. v. Signature Fin. Grp., Inc., 149 F.3d 1368 (Fed. Cir. 1998), 1-10, 14-40
STC UNM v. Intel Corp., 2011 U.S. Dist. LEXIS 15439, 2011 WL 7562686 (D.N.M. Dec. 22, 2011), 8-8
STC.UNM v. Intel Corp., 754 F.3d 940 (Fed. Cir. 2014), 2-30
Stelma, Inc. v. Bridge Elec. Co., 300 F.2d 761 (3d Cir. 1962), 13-5
Steuben Foods, Inc. v. Oystar Grp., 2013 U.S. Dist. LEXIS 187536, 2013 WL 2105894 (W.D.N.Y. May 14, 2013), 2-38
Stevenson v. Sears, Roebuck & Co., 713 F.2d 705 (Fed. Cir. 1983), 5-93
Stevenson v. Union Pac. RR, 354 F.3d 739 (8th Cir. 2004), 4-42
Stragent, LLC v. Intel Corp., No. 11-cv-421, 2014 U.S. Dist. LEXIS 169080, 2014 WL 6756304 (E.D. Tex. Aug. 6, 2014), 9-15
Structural Rubber Prods. Co. v. Park Rubber, 749 F.2d 707 (Fed. Cir. 1984), 7-6, 8-42
Sud-Chemie, Inc. v. CSP Techs., Inc., 2006 U.S. Dist. LEXIS 54873, 2006 WL 2246404 (S.D. Ind. Aug. 4, 2006), 14-66
Sullivan, *In re*, 498 F.3d 1345 (Fed. Cir. 2007), 14-75
Summit 6, LLC v. Samsung Elecs. Co., 802 F.3d 1283 (Fed. Cir. 2015), 9-7, 14-108
Summit Data Systems, LLC v. EMC Corp., No. 10-749, 2014 U.S. Dist. LEXIS 138248, 2014 WL 4955689 (D. Del. Sept. 25, 2014), 9-13
Sulzer Textil A.G. v. Picanol N.V., 358 F.3d 1356 (Fed. Cir. 2004), 2-15
Sun Microsystems v. Dataram Corp., Civ. No. 96-20708 SW, 1997 WL 50272, 1997 U.S. Dist. LEXIS 4557 (N.D. Cal. Feb. 4, 1997), 2-45
Sun Studs, Inc. v. ATA Equip. Leasing, Inc., 872 F.2d 978 (Fed. Cir. 1989), 14-57
Sundance, Inc. v. DeMonte Fabricating Ltd., 550 F.3d 1356 (Fed. Cir. 2008), 14-72
Superguide Corp. v. DirecTV Enters., Inc., 358 F.3d 870 (Fed. Cir. 2004), 5-57
Swanson, *In re*, 540 F.3d 1368 (Fed. Cir. 2008), 5-101, 14-25
Symbol Technologies, Inc. v. Lemelson Med., Educ. & Research Found., L.P., 422 F.3d 1378 (Fed. Cir. 2005), 14-96
Syngenta Seeds v. Delta Cotton Co-operative, Inc., 457 F.3d 1269 (Fed. Cir. 2006), 12-9
Syntex Pharmaceutical Int'l, Ltd. v. K-Line Pharm., Ltd., 905 F.2d 1525 (Fed. Cir. 1990), 5-93
Takeda Chemical Indus. v. Alphapharm Pty., Ltd., 492 F.3d 1350 (Fed. Cir. 2007), 14-74
Tamoxifen Citrate Antitrust Litigation, *In re*, 429 F.3d 370 (2d Cir. 2005), 10-20
Tanabe Seiyaku Co., Ltd. v. U.S. Int'l Trade Comm'n, 109 F.3d 726 (Fed. Cir. 1997), 5-39
Tanaka, *In re*, 640 F.3d 1246 (Fed. Cir. 2011), 14-20-14-21
Tango Transportation, LLC v. Transp. Int'l Pool, Inc., No. 5:08-CV-0559, 2009 WL 3254882 (W.D. La. Oct. 8, 2009), 4-39
Tank Insulation Int'l, Inc. v. Insultherm, Inc., 104 F.3d 83 (5th Cir. 1997), 2-46
Tap Pharmaceutical Products v. Atrix Labs., Inc., No. 03 C 7822, 2004 WL 2034073, 2004 U.S. Dist. LEXIS 17118 (N.D. Ill. Aug. 26, 2004), 2-18
Tap Pharmaceutical Products, Inc. v. Owl Pharmaceuticals, L.L.C., 419 F.3d 1346 (Fed. Cir. 2005), 5-41

Patent Case Management Judicial Guide, Third Edition

- Tate Access Floors, Inc. v. Interface Architectural Resources, Inc., 279 F.3d 1357 (Fed. Cir. 2002), 5-98, 14-88
- Tate Access Floors, Inc. v. Maxcess Techs., Inc., 222 F.3d 958 (Fed. Cir. 2000), 9-11
- The Tawnsaura Group LLC v. Maximum Human Performance LLC, No. 12-cv-7189 (C.D. Cal. Sept. 4, 2014), 9-16
- Technology Licensing Corp. v. Technicolor USA, Inc., 2010 U.S. Dist. LEXIS 113292, 2010 WL 4292275 (E.D. Cal. 2010), 5-20
- TechRadium, Inc. v. FirstCallNetwork, Inc., No. 13-2487, 2015 U.S. Dist. LEXIS 23796, 2015 WL 862326 (S.D. Tex. Feb. 27, 2015), 9-14
- TechSearch v. Intel, 286 F.3d 1360 (Fed. Cir. 2002), 5-16, 5-18, 5-19, 8-23
- TecSec, Inc. v. IBM Corp., 731 F.3d 1336 (Fed. Cir. 2013), 5-96
- Tegal Corp. v. Tokyo Electron Am. Inc., 257 F.3d 1331 (Fed. Cir. 2001), 10-10
- Telcordia Technologies, Inv. v. Cisco Systems, 612 F.3d 1365 (Fed. Cir. 2010), 9-6
- Teledyne Indus., Inc. v. NLRB, 911 F.2d 1214 (6th Cir. 1990), 5-97
- Teleflex Inc. v. KSR Int'l, 298 F. Supp. 2d 581 (E.D. Mich. 2003), 14-65
- Teleflex, Inc. v. Ficosa N. Am. Corp., 299 F.3d 1313 (Fed. Cir. 2002), 14-50
- Telemac Cellular Corp. v. Topp Telecom, Inc., 247 F.3d 1316 (Fed. Cir. 2001), 6-26, 6-27
- Terrorist Bombings of U.S. Embassies in East Africa, *In re*, 552 F.3d 93 (2d Cir. 2008), 4-36
- Testa v. Wal-Mart Stores, Inc., 144 F.3d 173 (1st Cir. 1998), 4-35
- Teva Pharmaceuticals USA, Inc. v. Novartis Pharm. Corp., 482 F.3d 1330 (Fed. Cir. 2007), 10-12, 10-13
- Teva Pharmaceuticals USA, Inc. v. Sandoz, Inc., 135 S. Ct. 831 (2015), 1-2, 2-13, 2-19, 2-76, 5-4, 5-8, 5-21, 5-29, 5-86, 6-3, 6-7, 6-15, 6-36, 6-37
- Texas Digital Systems, Inc. v. Telegenix, Inc., 308 F.3d 1193 (Fed. Cir. 2002), 5-36, 5-57, 5-58, 5-103
- Texas Instruments, Inc. v. Cypress Semiconductor Corp., 90 F.3d 1558 (Fed. Cir. 1996), 2-50, 5-75, 5-101, 14-117
- Texas Instruments, Inc. v. Int'l Trade Comm'n, 871 F.2d 1054 (Fed. Cir. 1989), 6-7
- Texas Instruments, Inc. v. Linear Techs. Corp., 182 F. Supp. 2d 580 (E.D. Tex. 2002), 5-90, 5-98, 5-100
- Texas Instruments, Inc. v. Tessera, Inc., 231 F.3d 1325 (Fed. Cir. 2000), 3-29
- Texas Instruments, Inc. v. United States International Trade Commission, 988 F.2d 1165 (Fed. Cir. 1993), 14-69
- Textile Products, Inc. v. Mead Corp., 134 F.3d 1481 (Fed. Cir. 1998), 2-29, 2-61
- Therasense, Inc. v. Becton, Dickinson & Co., 649 F.3d 1276 (Fed. Cir. 2011), 2-45, 2-75, 4-26, 6-8, 6-44, 14-94
- Thomson-Houston Elec. Co. v. Ohio Brass Co., 80 F. 712 (6th Cir. 1897), 1-7
- Thorington, *In re*, 418 F.2d 528 (C.C.P.A. 1969), 11-4
- Thorner v. Sony Comput. Entm't Am. LLC, 669 F.3d 1362 (Fed. Cir. 2012), 5-58, 5-67, 5-103
- Tilghman v. Proctor, 102 U.S. 707 (1880), 1-7, 7-14
- Time Insurance Co. v. AstraZeneca AB, No. 14-4149, 2014 WL 4933025 (E.D. Pa. Oct. 1, 2014), 10-24
- Titan Tire Corp. v. Case New Holland, Inc., 566 F.3d 1372 (Fed. Cir. 2009), 11-11, 11-12
- Titanium Metals Corp. v. Banner, 778 F.2d 775 (Fed. Cir. 1985), 14-52
- TiVo Inc. v. EchoStar Corp., 646 F.3d 869 (Fed. Cir. 2011), 9-8, 9-9
- TiVo, Inc. v. EchoStar Communications Corp., 516 F.3d 1290 (Fed. Cir. 2008), 5-72
- TM Patents, L.P. v. IBM Corp., 72 F. Supp. 2d 370 (S.D.N.Y. 1999), 5-93, 5-94, 5-96

Table of Cases

Tokai Corp. v. Easton Enters., Inc., 632 F.3d 1358 (Fed. Cir. 2011), 6-16, 7-11

Tone Brothers, Inc. v. Sysco Corp., 28 F.3d 1192 (Fed. Cir. 1994), 11-11

Topliff v. Topliff, 145 U.S. 156 (1892), 7-14

Tormenia v. First Investors Realty Co., Inc., 251 F.3d 128 (3d Cir. 2000), 7-29

Toro Co. v. White Consol. Indus., 383 F.3d 1326 (Fed. Cir. 2004), 9-22, 14-86

Toro Co. v. White Consol. Indus., Inc., 199 F.3d 1295 (Fed. Cir. 1999), 5-74

Townsend v. Smith, 36 F.2d 292 (C.C.P.A. 1929), 14-55

Townshend Intellectual Prop., L.L.C. v. Broadcom Corp., 2008 U.S. Dist LEXIS 7393, 2008 WL 171039 (N.D. Cal. Jan. 18, 2008), 5-100

Toxgon Corp. v. BNFL, Inc., 312 F.3d 1379 (Fed. Cir. 2002), 13-6

Toyota Motor Corp., *In re*, 474 F.3d 1338 (Fed. Cir. 2014), 2-63, 2-64

Trading Technologies Int'l, Inc. v. eSpeed, Inc., 595 F.3d 1340 (Fed. Cir. 2010), 5-65, 7-49

Trading Technologies Int'l, Inc. v. Open E Cry, LLC, 728 F.3d 1309 (Fed. Cir. 2013), 5-38

Traffix Devices, Inc. v. Marketing Displays, Inc., 532 U.S. 23 (2001), 11-6, 11-11

Trans Texas Holdings Corp., *In re*, 498 F.3d 1290 (Fed. Cir. 2007), 7-11

Transco v. Performance Contracting, Inc., 38 F.3d 551 (Fed. Cir. 1994), 14-50

Transonic Systems, Inc. v. Non-Invasive Medical Technologies Corp., 75 F. App'x 765 (Fed. Cir. 2003), 5-93, 5-94

Transperfect Global, Inc. v. Motionpoint Corp., No. 10-cv-2590, 2014 U.S. Dist. LEXIS 159805, 2014 WL 6068384 (N.D. Cal. Nov. 13, 2014), 9-15

Trask-Morton v. Motel 6 Operating L.P., 534 F.3d 672 (7th Cir. 2008), 4-20

Trebro Manufacturing, Inc. v. Firefly Equip., LLC, 748 F.3d 1159 (Fed. Cir. 2014), 3-9, 3-11, 3-12, 3-16, 14-102

Trintec Industries, Inc. v. Pedre Promotional Prods., Inc., 395 F.3d 1275 (Fed. Cir. 2005), 2-60

Triton Tech of Tex., LLC v. Nintendo of Am., Inc., 753 F.3d 1375 (Fed. Cir. 2014), 5-82

Trull v. Volkswagen of Am., Inc., 187 F.3d 88 (1st Cir. 1999), 4-35

Trusted Integration, Inc. v. United States, 659 F.3d 1159 (Fed. Cir. 2011), 13-6

TS Tech USA Corp., *In re*, 551 F.3d 1315 (Fed. Cir. 2008), 2-62, 2-64, 5-27

TV Interactive Data Corp. v. Sony Corp., 929 F. Supp. 2d 1006 (N.D. Cal. 2013), 8-39, 14-109

TWM Manufacturing Co. v. Dura Corp., 592 F.2d 346 (6th Cir. 1979), 14-96

TWM Manufacturing Co. v. Dura Corp., 789 F.2d 895 (1986), 7-20

Tyco Fire Prods. LP v. Victaulic Co., 777 F. Supp. 2d 921 (E.D. Pa. 2011), 2-44

Tyco Healthcare Grp. LP v. Mutual Pharm. Co., 762 F.3d 1338 (Fed. Cir. 2014), 10-5

U.S. Bancorp Mortg. Co. v. Bonner Mall P'ship, 513 U.S. 18 (1994), 5-102, 9-19

U.S. Leather, Inc. v. H&W P'ship, 60 F.3d 222 (5th Cir. 1995), 9-17

U.S. Steel Corp. v. United States, 730 F.2d 1465 (Fed. Cir. 1984), 4-12, 4-31

U.S. Surgical Corp. v. Ethicon, Inc., 103 F.3d 1554 (Fed. Cir. 1997), 5-30

Ultimate Combustion Co., Inc. v. Fuecotech, Inc., No. 12-cv-60545 (S.D. Fla. June 24, 2014), 9-13

UltimatePointer, LLC v. Nintendo Co. Ltd., No. 14-cv-00865, 2015 U.S. Dist. LEXIS 83625, 2015 WL 3822577 (W.D. Wash. Mar. 9, 2015), 9-13

Ultramercial, Inc. v. Hulu, LLC, 772 F.3d 709 (2014), 6-18, 6-19, 6-31, 6-32, 14-44

Ultratec, Inc. v. Captel, Inc., 2014 U.S. Dist. LEXIS 120062 (W.D. Wis. Nov. 14, 2013), 2-57

Ultratec Inc. v. Sorenson Communications Inc., 2014 WL 4976596 (W.D. Wis. Oct. 3, 2014), 2-43

Patent Case Management Judicial Guide, Third Edition

Underwater Devices Inc. v. Morrison-Knudsen Co., 717 F.2d 1380 (Fed. Cir. 1983), 14-112

Uniloc USA, Inc. v. Microsoft Corp., 632 F.3d 1292 (Fed. Cir. 2011), 1-2, 1-10, 6-41, 6-43, 7-20, 7-23, 7-36, 8-35, 8-36, 8-38, 8-40, 14-107, 14-108

Union Carbide Chems. & Plastics Tech. Corp. v. Shell Oil Co., 308 F.3d 1167 (Fed. Cir. 2002), 8-41

Union Manufacturing Co. v. Han Baek Trading Co., 763 F.2d 42 (2d Cir. 1985), 2-50

Uniroyal Engineered Prods., LLC v. Omnova Solutions Inc., 2009 U.S. Dist. LEXIS 22518, 2009 WL 736700 (W.D. Wis. 2009), 2-51

Unisplay, S.A. v. American Elec. Sign Co., 69 F.3d 512 (Fed. Cir. 1995), 6-6, 7-34, 7-35

United Carbon Co. v. Binney & Smith Co., 317 U.S. 228 (1942), 5-49

United Food & Commercial Workers Local 1776 & Participating Emp'rs Health and Welfare Fund v. Teikoku Pharma USA, Inc., No. 14-md-02521-WHO, 2014 WL 6465235 (N.D. Cal. Nov. 17, 2014), 10-22

United Medical Supply Co. v. United States, 77 Fed. Cl. 257 (2007), 4-47

United States *ex. rel.* Bagley v. TRW, Inc., 204 F.R.D. 170 (C.D. Cal. 2001), 4-11

United States v. Adams, 383 U.S. 39 (1966), 14-69

United States v. Ajmal, 67 F.3d 12 (2d Cir. 1995), 8-20

United States v. Armour & Co., 402 U.S. 673 (1971), 5-95

United States v. Balsam, 203 F.3d 72 (1st Cir. 2000), 8-20

United States v. Bansal, 663 F.3d 634 (3d Cir. 2011), 8-27

United States v. Brodie, 858 F.2d 492 (9th Cir. 1988), 7-28

United States v. Harvey Steel Co., 196 U.S. 310 (1905), 14-99

United States v. Huebner, 48 F.3d 376 (9th Cir. 1994), *cert. denied*, 516 U.S. 816 (1995), 8-20

United States v. Kellington, 217 F.3d 1084 (9th Cir. 2000), 9-21

United States v. Klee, 494 F.2d 394 (9th Cir. 1974), 8-19

United States v. Marler, 614 F.2d 47 (5th Cir. 1980), 7-29

United States v. Mitchell, 445 U.S. 535 (1980), 13-1

United States v. Nobles, 422 U.S. 225 (1975), 2-43

United States v. Rhodes, 631 F.2d 43 (5th Cir. 1980), 8-20

United States v. Richardson, 233 F.3d 1285 (11th Cir. 2000), 8-21

United States v. Rodriguez-Pacheco, 475 F.3d 434 (1st Cir. 2007), 5-91

United States v. Sutton, 970 F.2d 1001 (1st Cir. 1992), 8-20

United States v. Tohono O'Odham Nation, 131 S. Ct. 1723 (2011), 13-6

United States v. Wilson, 133 F.3d 251 (4th Cir. 1997), 7-28

United States v. Young, 804 F.2d 116 (8th Cir. 1986), 5-92

Unitherm Food Systems, Inc. v. Swift-Eckrich, Inc., 546 U.S. 394 (2006), 8-40, 14-115

University of California v. Oncor Inc., No. C-95-3084-VRW, 1997 U.S. Dist. LEXIS 15068, 1997 WL 670674 (N.D. Cal. Aug. 19, 1997), 8-23

University of Rochester v. G.D. Searle & Co., 358 F.3d 916 (Fed. Cir. 2004), 6-16

University of Texas v. Camenisch, 451 U.S. 390 (1981), 3-8, 5-93

Universal Electronics Inc. v. Universal Remote Control Inc., 2014 U.S. Dist. LEXIS 182754, 2014 WL 10253110 (C.D. Cal. Apr. 21, 2014), 7-54

Universal Electronics, Inc. v. Universal Remote Control, Inc., 943 F. Supp. 2d 1028 (C.D. Cal. 2013), 2-56, 9-13

Table of Cases

Universal Electronics, Inc. v. Universal Remote Control, Inc., No. 12-cv-329, 2015 U.S. Dist. LEXIS 91403 (C.D. Cal. Mar. 10, 2015), 9-13

Universal Service Fund Telephone Billing Practices Litigation, *In re*, 232 F.R.D. 669 (D. Kan. 2005), 4-73

Upjohn Co. v. Syntro Corp., 1990 U.S. Dist. LEXIS 11512, 1990 WL 79232 (D. Del. 1990), 2-37

Uship Intellectual Props., LLC v. United States, 714 F.3d 1311 (Fed. Cir. 2013), 5-60, 5-68

Uusi LLC, *In re*, 549 F. App'x 964 (Fed. Cir. 2013), 13-8

Virginia Panel Corp. v. MAC Panel Co., 133 F.3d 860 (Fed. Cir. 1997), 9-11, 14-94

Vaeck, *In re*, 947 F.2d 488 (Fed. Cir. 1991), 14-49

Vas-Cath Inc. v. Mahurkar, 935 F.2d 1555 (Fed. Cir. 1991), 14-47

Vaupel Textilmaschinen KG v. Meccanica Euro Italia SPA, 944 F.2d 870 (Fed. Cir. 1991), 2-29, 2-30

Vederi, LLC v. Google, Inc., 744 F.3d 1376 (Fed. Cir. 2014), 5-42

Velez v. Marriott PR Mgmt., Inc., 590 F. Supp. 2d 235 (D.P.R. 2008), 4-35

Ventana Medical Systems, Inc. v. Biogenex Labs., Inc., 473 F.3d 1173 (Fed. Cir. 2006), 5-38, 5-66

Verdegaal Bros., Inc. v. Union Oil Co. of Cal., 814 F.2d 628 (Fed. Cir. 1987), 14-52

Verizon Business Network Services, *In re*, 635 F.3d 559, (Fed. Cir. 2011), 2-64

Verizon California Inc. v. Ronald A. Katz Tech. Licensing, P.A., 326 F. Supp. 2d 1060 (C.D. Cal. 2003), 5-98, 8-29

Verizon Services Corp. v. Vonage Holdings Corp., 503 F.3d 1295 (2007), 9-3

Versata Software, Inc. v. Cloud9 Analytics, Inc., 2014 U.S. Dist. LEXIS 19994, 2014 WL 631517 (D. Del. Feb. 18, 2014), 2-40

Versata Software, Inc. v. SAP, Inc., 717 F.3d 1255 (Fed. Cir. 2013), 8-40

Versata Software, Inc. v. Volusion, Inc., 2013 U.S. Dist. LEXIS 182842, 2013 WL 6912688 (W.D. Tex. June 20, 2013), 2-57

Vertical Computer Systems, Inc. v. LG Elecs. MobileComm U.S.A., Inc., 2013 U.S. Dist. LEXIS 71561, 2013 WL 2241947 (E.D. Tex. May 21, 2013), 2-38

V-Formation, Inc. v. Benetton Grp. SpA, 401 F.3d 1307 (Fed. Cir. 2005), 5-39

Victor Stanley, Inc. v. Creative Pipe, Inc., 269 F.R.D. 497 (D. Md. 2010), 4-17, 4-35

View Engineering, Inc. v. Robotic Vision Systems, Inc., 208 F.3d 981 (Fed. Cir. 2000), 4-25

Vigil v. Walt Disney Co., 2000 U.S. App. LEXIS 6231, 2000 WL 353148 (Fed. Cir. 2000), 2-58

Violation of Rule 28(d), *In re*, 635 F.3d 1352 (Fed. Cir. 2011), 4-10

VirnetX, Inc. v. Cisco Systems, Inc., 767 F.3d 1308 (Fed. Cir. 2014), 2-81, 5-67, 6-43, 7-19, 7-23, 7-37, 8-30, 8-35, 8-36, 8-37, 8-38, 14-107, 14-108

VirtualAgility, Inc. v. Salesforce.com, Inc., 759 F.3d 1307 (Fed. Cir. 2014), 2-58

Viskase Corp. v. Am. Nat'l Can Co., 261 F.3d 1316 (Fed. Cir. 2001), 2-55

Viskase Cos. v. World Pac. Int'l AG, 710 F. Supp. 2d 754 (N.D. Ill. 2010), 2-58

Vista Manufacturing Inc. v. Trac-4 Inc., 131 F.R.D. 134 (N.D. Ind. 1990), 2-58

Vistaprint, Ltd., *In re*, 628 F.3d 1452 (Fed. Cir. 2010), 2-64

Visto Corp. v. Sproqit Techs., Inc., 445 F. Supp. 2d 1104 (N.D. Cal. 2006), 5-96, 5-98

Vitronics Corp. v. Conceptronic, Inc., 90 F.3d 1576 (Fed. Cir. 1996), 2-19, 5-36, 5-103

Vivid Technologies, Inc. v. American Sci. & Eng'g, Inc., 200 F.3d 795 (Fed. Cir. 1999), 2-46, 5-12

Voda v. Cordis Corp., 2006 U.S. Dist. LEXIS 97321, 2006 WL 5347777 (W.D. Okla. May 10, 2006), 7-57, 9-4

Voda v. Cordis Corp., 476 F.3d 887 (Fed. Cir. 2007), 14-117

Patent Case Management Judicial Guide, Third Edition

Vogel, *In re*, 422 F.2d 438 (C.C.P.A. 1970), 14-98
Voice Technologies Group, Inc. v. VMC Systems, Inc., 164 F.3d 605 (Fed. Cir. 1999), 4-15
Volkswagen of America, Inc., *In re*, 545 F.3d 304 (5th Cir. 2008), 2-62
Volkswagen of America, Inc., *In re*, 566 F.3d 1349 (Fed. Cir. 2009), 2-64
Vulcan Engineering Co. v. Fata Aluminum, Inc., 278 F.3d 1366 (Fed. Cir. 2002), 6-9
W.L. Gore & Assocs., Inc. v. Garlock, Inc., 721 F.2d 1540 (Fed. Cir. 1983), 14-53, 14-69
Waid v. Merrill Area Pub. Sch., 91 F.3d 857 (7th Cir. 1996), 5-90
Walker Process Equip., Inc. v. Food Mach. & Chem. Corp., 382 U.S. 172 (1965), 2-46, 14-100
Wallace v. Holmes, 29 F. Cas. 74 (No. 17,100) (C.C. Conn. 1871), 1-7
Wal-Mart Stores, Inc. v. Samara Bros., Inc., 529 U.S. 205 (2000), 11-6
Wands, *In re*, 858 F.2d 731 (Fed. Cir. 1988), 6-27, 14-49
Wang Laboratories, Inc. v. Mitsubishi Elecs. Am., Inc., 103 F.3d 1571 (Fed. Cir. 1997), 14-90
Warner-Jenkinson Co. v. Hilton Davis Chem. Co., 520 U.S. 17 (1997), 6-4, 6-5, 6-27, 8-43, 14-82, 14-83
Warner-Lambert Co. v. Apotex Corp., 316 F.3d 1348 (Fed. Cir. 2003), 10-4
Warrior Sports, Inc. v. Dickinson Wright, P.L.L.C., 631 F.3d 1367 (Fed. Cir. 2011), 2-60
Warrior Sports, Inc. v. STX, L.L.C., 2008 WL 783768, 2008 U.S. Dist. LEXIS 21387 (E.D. Mich. Mar. 19, 2008), 3-26
Watkins v. Nw. Ohio Tractor Pullers Ass'n, Inc., 630 F.2d 1155 (6th Cir. 1980), 2-37
Wave Loch, Inc. v. Am. Wave Machs., Inc., No. 08-cv-00928 (S.D. Cal. Jan. 26, 2015), 9-14
WBIP, LLC v. Kohler Co., ___ F.3d ___ (Fed. Cir. July 19, 2016), 6-6, 7-15, 8-6
Webb, *In re*, 916 F.2d 1553 (Fed. Cir. 1990), 11-3
Webster Electric Co. v. Splitdorf Elec. Co., 264 U.S. 463 (1924), 1-8
Western Union Co. v. MoneyGram Payment Systems, 626 F.3d 1361 (Fed. Cir. 2010), 8-41
Westinghouse Electric & Mfg. Co. v. Formica Insulation Co., 266 U.S. 342 (1924), 14-98
Westinghouse Electric & Mfg. Co. v. Wagner Co., 225 U.S. 604 (1912), 7-21, 14-107
Westinghouse v. Boyden Power Brake Co., 170 U.S. 537 (1898), 1-8
West View Research, LLC Patent Cases, *In re* (S.D. Cal. Apr. 25, 2015), 2-79
White v. Jeffrey Mining Co., 723 F.2d 1553 (Fed. Cir. 1983), 8-32
WhitServe, LLC v. Computer Packages, Inc., 694 F.3d 10 (Fed. Cir. 2012), 8-37, 8-40, 14-108
Whittemore v. Cutter, 29 F. Cas. 1120 (C.C. Mass. 1813), 1-6
Wi-Lan, Inc. v. Apple Inc., 811 F.3d 455 (Fed. Cir. 2016), 5-10
Williams v. Jader Fuel Co., Inc., 944 F.2d 1388 (7th Cir. 1992), 8-17
Williamson v. Citrix Online, LLC, 2015 U.S. App. LEXIS 10082, 2015 WL 3687459 (Fed. Cir. 2015), 5-61, 5-80, 14-81-14-82
Wilson Sporting Goods Co. v. David Geoffrey & Assocs., 904 F.2d 677 (Fed. Cir. 1990), 6-4, 6-39, 9-17, 14-85, 14-86
Wilson Sporting Goods Co. v. Hillerich Bradsby Co., 442 F.3d 1322 (Fed. Cir. 2006), 2-24, 5-23
Wilton v. Seven Falls Co., 515 U.S. 277 (1995), 2-35, 2-51
Winans v. Denmead, 56 U.S. 330 (1854), 1-7
Winbond Electronics Corp. v. ITC, 262 F.3d 1363 (Fed. Cir. 2001), 4-29
Windsurfing International v. Ostermann, 534 F. Supp. 581 (S.D.N.Y. 1982), 13-5
Windsurfing International, Inc. v. AMF, Inc., 782 F.2d 995 (Fed. Cir. 1986), 3-8, 9-3
Windsurfing International, Inc. v. Fred Ostermann GmbH, 613 F. Supp. 913 (S.D.N.Y. 1985), 14-67

Table of Cases

Winner International Royalty Corp. v. Wang, 202 F.3d 1340 (Fed. Cir. 2000), 6-8
WMS Gaming Inc. v. Int'l Game Tech., 184 F.3d 1339 (Fed. Cir. 1999), 7-11, 14-86
Wood v. Atlantic Gulf & Pac. Co., 296 F. 718 (S.D. Ala. 1924), 13-4
Woodbridge v. United States, 263 U.S. 50 (1923), 1-8
Woodland Trust v. Flowertree Nursery, Inc., 148 F.3d 1368 (Fed. Cir. 1998), 14-53
Woods v. DeAngelo Marine Exhaust, Inc., 692 F.3d 1272 (Fed. Cir. 2012), 2-58
Wordtech Systems v. Integrated Network Solutions, Inc., 609 F.3d 1308 (Fed. Cir. 2010), 4-32, 8-37, 8-41
Wright v. City of Salisbury, No. 2:07CV0056 AGF, 2010 WL 126011 (E.D. Mo. Apr. 6, 2010), 4-42
Wyer, *In re*, 655 F.2d 221 (C.C.P.A. 1981), 8-27
Wyers v. Master Lock Co., 616 F.3d 1231 (Fed. Cir. 2010), 7-12, 14-72
Yarway Corp. v. Eur-Control USA, Inc., 775 F.2d 268 (Fed. Cir. 1985), 9-10
Yoder Brothers, Inc. v. Cal.-Fla. Plant Corp., 537 F.2d 1347 (5th Cir. 1976), 12-5, 12-7, 12-8
York Products, Inc. v. Cent. Tractor Farm & Family Ctr., 99 F.3d 1568 (Fed. Cir. 1996), 5-73, 5-75
z4 Technologies Inc. v. Microsoft Corp., 434 F. Supp. 2d 437 (E.D. Tex. 2006), 3-15, 3-16, 9-4
Zahn, *In re*, 617 F.2d 261 (C.C.P.A. 1980), 11-2, 11-3
Zenith Radio Corp. v. United States, 783 F.2d 184 (Fed. Cir. 1986), 5-99
Zillow v. Trulia, 2013 U.S. Dist. LEXIS 144919, 2013 WL 5530573 (W.D. Wash. Oct. 7, 2013), 2-58
Zimmer Holdings, Inc., *In re*, 609 F.3d 1378 (Fed. Cir. 2010), 2-64
Zodiac Pool Care, Inc. v. Hoffinger Indus., Inc., 206 F.3d 1408 (Fed. Cir. 2000), 5-75
Zoltek Corp. v. United States, 442 F.3d 1345 (Fed. Cir. 2006), 13-7
Zoltek Corp. v. United States, 672 F.3d 1309 (Fed. Cir. 2012), 13-4, 13-7
Zubulake v. UBS Warburg, LLC, 217 F.R.D. 309 (S.D.N.Y. 2003), 4-16, 4-20, 4-21, 4-36

Author Biographies

Peter S. Menell is the Koret Professor of Law at the University of California, Berkeley School of Law, where he specializes in intellectual property law. In 1995, he co-founded the Berkeley Center for Law & Technology, which has been instrumental in Berkeley Law being named the top intellectual property program in the nation for nearly two decades. Professor Menell earned his B.S. from M.I.T., M.A. and Ph.D. in Economics from Stanford University, and J.D. from Harvard Law School, where he served as an editor of the *Harvard Law Review*. After graduating from law school, he clerked for Judge Jon O. Newman of the Court of Appeals for the Second Circuit. Professor Menell has written more than 70 articles and 10 books, including *Intellectual Property in the New Technological Age* (with R. Merges and M. Lemley, now in its eighth edition, 2016) and *Software and Internet Law* (with M. Lemley, R. Merges, P. Samuelson, and B. Carver, 4th ed. 2011). Professor Menell has organized more than 50 intellectual property education programs for the Federal Judicial Center since 1998. Professor Menell founded and supervises the *Annual Review of Law and Technology* (now in its nineteenth year, published by the *Berkeley Technology Law Journal*). He has advised the U.S. Congress, federal agencies, state attorneys general, and technology and entertainment companies on a wide range of intellectual property and antitrust matters. He is a member of the District of New Jersey Local Patent Rules Advisory Committee and the Court of Federal Claims Advisory Council. He served from 2012–2013 as one of the inaugural scholars in the USPTO’s Thomas Alva Edison Visiting Professionals Program.

Lynn H. Pasahow is a partner in the Litigation Group at Fenwick & West, where he specializes in patent litigation. He has represented cutting-edge technology companies and universities and their Nobel laureate and other inventors in patent and other intellectual property litigation in the software, Internet, and biotech industries. Mr. Pasahow is a coauthor, with Judge William W Schwarzer, of *Civil Discovery: A Guide to Efficient Practice*. He co-teaches an intellectual property course at the University of California, San Francisco, and regularly lectures about intellectual property law subjects to groups that have included the Federal Judicial Center, the American Association for the Advancement of Science, the American Law Institute, the Practising Law Institute, and the University of California, Berkeley School of Law. Mr. Pasahow earned his B.A. from Stanford University and his J.D. from the University of California, Berkeley School of Law.

James Pooley advises clients on patent and trade secret matters in Silicon Valley. He served from 2009 through 2014 as deputy director general, Innovation and Technology Section, at the World Intellectual Property Organization (WIPO). Prior to that appointment, Mr. Pooley was a partner at Morrison and Foerster, where he specialized in intellectual property and technology-related commercial litigation. Mr. Pooley is the author of the treatise *Trade Secrets* (Law Journal Press), *Secrets: Managing Information Assets in the Age of Cyberespionage* (Verus Press 2015), and numerous other professional publications in the field of intellectual property. He is a for-

mer president of the American Intellectual Property Law Association and the National Inventors Hall of Fame. Mr. Pooley has taught as an adjunct professor of law at the University of California, Berkeley School of Law. He is a fellow of the California Council on Science and Technology and a member of the National Academy of Sciences Committee on Intellectual Property Rights. Mr. Pooley conceived and scripted an instructional video for jurors in patent cases that was produced by the Federal Judicial Center. Mr. Pooley earned his B.A. from Lafayette College and his J.D. from Columbia University School of Law.

Matthew D. Powers is the lead partner at Tensegrity Law Group, LLP. He is one of the nation's most experienced patent trial lawyers. He has litigated and tried cases in jurisdictions nationwide involving a wide range of technologies, including semiconductor, biomedical, computer, computer peripherals, cellular, holographic, digital media and specialty chemical products. He has published articles on various aspects of intellectual property law and litigation. Mr. Powers has taught as an adjunct professor of law at the University of California, Berkeley School of Law. Mr. Powers earned his B.S. from Northwestern University and his J.D. from Harvard Law School.

Steven C. Carlson is managing partner in the Silicon Valley office of Kasowitz, Benson, Torres & Friedman LLP, where he specializes in patent litigation. He served as a judicial law clerk to Judge Roderick R. McKelvie of the U.S. District Court for the District of Delaware and to Judge Paul R. Michel of the U.S. Court of Appeals for the Federal Circuit. He earned his B.A. from Reed College and his J.D. from Yale Law School, where he served as an editor of the *Yale Law Journal*.

Jeffrey G. Homrig is a partner in the Silicon Valley office of Latham & Watkins LLP. He has extensive experience as a litigator and trial lawyer in complex and high-stakes patent cases for leading technology companies. He graduated from University of California, Berkeley School of Law, and holds a B.A. from the University of California, Berkeley.

George F. Pappas is a partner at Covington & Burling LLP, where he specializes in patent litigation. He is a fellow of the American College of Trial Lawyers and the chair of its Complex Litigation Committee. He also chairs the Editorial Committee and is one of the coauthors of *Anatomy of a Patent Case* (2d ed. 2012), published in conjunction with the Federal Judicial Center. He received his undergraduate and law degrees from the University of Maryland.

Carolyn Chang is a partner at Fenwick & West's Silicon Valley office, where she specializes in patent litigation. She received her B.A. from the University of California, Berkeley, and her J.D. from the University of California, Hastings College of the Law.

Author Biographies

Colette Reiner Mayer is a partner at Morrison & Foerster's Silicon Valley office, where she specializes in patent litigation. She earned her B.S. from M.I.T. and her J.D. from Cardozo School of Law.

Marc David Peters is a partner at Morrison & Foerster's Silicon Valley office, where he specializes in patent and trade secret litigation. He earned his B.A. from Harvard University, his M.A. and Ph.D. in Physics from the University of California, Berkeley, and his J.D. from Stanford Law School.

Collaborator Profiles

Anita Choi is an associate at Morrison & Foerster's Silicon Valley office, where she focuses on clean technology, biofuels, agricultural biotechnology, life sciences, biotechnology, pharmaceuticals, molecular diagnostics, and material sciences. She earned her B.S. from the California Institute of Technology, her M.B.A. from the Wharton School of Business, and her J.D. from the University of Pennsylvania Law School.

John Fargo serves as the director of the Intellectual Property Staff within the Commercial Litigation Branch of the Civil Division at the U.S. Department of Justice. He specializes in intellectual property litigation at the Federal Court of Claims. He earned his B.S. in Industrial Engineering and his J.D. at the State University of New York at Buffalo.

Michael Sawyer is an associate in the Washington, D.C., office of Covington & Burling where he specializes in patent litigation. He served as a judicial law clerk to Judge William C. Bryson of the U.S. Court of Appeals for the Federal Circuit. He earned his B.S. in Computer Science and Mathematics at the University of Scranton and his J.D. from the University of California, Berkeley School of Law.

Allison A. Schmitt currently serves as a law clerk to the Honorable Stanley R. Chesler at the U.S. District Court for the District of New Jersey, after which she will be clerking for Judge Kathleen M. O'Malley of the U.S. Court of Appeals for the Federal Circuit. She earned her B.S. in Chemistry and Biochemistry from the University of Washington, her Ph.D. in Chemistry from Duke University, and her J.D. from the University of California, Berkeley School of Law.

Michael R. Ward is a partner at Morrison & Foerster's San Francisco office, where he specializes in intellectual property relating to plants and biotechnology. He earned his B.S. from the University of California, Berkeley, his M.S. in Agronomy and Ph.D. in Plant Physiology/Biochemistry from the University of California, Davis, and his J.D. from Golden Gate University School of Law.

Patricia Young is an associate at Latham & Watkins LLP, where she specializes in patent litigation. She received her S.B. from M.I.T. and her J.D. from Harvard Law School.

The Federal Judicial Center

Board

The Chief Justice of the United States, *Chair*

Judge Curtis L. Collier, U.S. District Court for the Eastern District of Tennessee

Magistrate Judge Jonathan W. Feldman, U.S. District Court for the Western District of New York

Judge Kent A. Jordan, U.S. Court of Appeals for the Third Circuit

Judge Kimberly J. Mueller, U.S. District Court for the Eastern District of California

Chief Judge C. Ray Mullins, U.S. Bankruptcy Court for the Northern District of Georgia

Judge George Z. Singal, U.S. District Court for the District of Maine

Judge David S. Tatel, U.S. Court of Appeals for the District of Columbia Circuit

James C. Duff, Director of the Administrative Office of the U.S. Courts

Director

Judge Jeremy D. Fogel

Deputy Director

John S. Cooke

About the Federal Judicial Center

The Federal Judicial Center is the research and education agency of the federal judicial system. It was established by Congress in 1967 (28 U.S.C. §§ 620–629), on the recommendation of the Judicial Conference of the United States.

By statute, the Chief Justice of the United States chairs the Center's Board, which also includes the director of the Administrative Office of the U.S. Courts and seven judges elected by the Judicial Conference.

The organization of the Center reflects its primary statutory mandates. The Education Division plans and produces education and training for judges and court staff, including in-person programs, video programs, publications, curriculum packages for in-district training, and Web-based programs and resources. The Research Division examines and evaluates current and alternative federal court practices and policies. This research assists Judicial Conference committees, who request most Center research, in developing policy recommendations. The Center's research also contributes substantially to its educational programs. The Federal Judicial History Office helps courts and others study and preserve federal judicial history. The International Judicial Relations Office provides information to judicial and legal officials from foreign countries and informs federal judicial personnel of developments in international law and other court systems that may affect their work. Two units of the Director's Office—the Information Technology Office and the Editorial & Information Services Office—support Center missions through technology, editorial and design assistance, and organization and dissemination of Center resources.